



User Manual

for use with the

PainSmart™ and PainSmart™ IOD Ambulatory Infusion System



Moog Medical Devices Group
tf 800.970.2337
ph 801.264.1001
fx 801.264.1051
www.moogmedical.com

Important Safety Note

- ▶ When using a Curlin Infusion Pump in a life sustaining situation, use AC Adapter, and provide an extra set of "C" cell batteries in addition to the batteries that are installed in the pump.
- ▶ Check pump between patient use per procedure (see maintenance chapter).
- ▶ Prior to Programming Load Dose, refer to Important Information in the appropriate Therapy chapters.



User Manual

for use with the

PainSmart™ and PainSmart™ IOD™
Ambulatory Infusion Systems



Manufactured by
ZEVEX, Inc.
4314 ZEVEX Park Lane
Salt Lake City, UT 84123 USA
Phone 801.264.1001
Fax 800.778.3135
www.moogmedical.com

For 24-hour Clinical or Technical Support call toll free:
1-800-970-2337

Covered by U.S. Patents 5,575,631 5,683,233 5,791,881 5,924,852 6,164,921 6,371,732 B1
Des. 408,911 Des. 437,547 S. Other U.S. and Foreign Patents Pending
Copyright © 2000/2011 Moog, Inc. All Rights Reserved

Revision K
Reorder Number 360-9043

TABLE OF CONTENTS

<p>INTRODUCTION..... 5</p> <p style="padding-left: 20px;">Delivery Mode and Routes 5</p> <p style="padding-left: 20px;">Indications for Use..... 5</p> <p style="padding-left: 20px;">Special Features of the Pump..... 6</p> <p style="padding-left: 20px;">Regulatory Agency Approvals..... 7</p> <p style="padding-left: 20px;">Warnings, Cautions, Notices 8</p> <p style="padding-left: 20px;">List of Abbreviations 13</p> <p>FEATURES OF THE PUMP AND ADMINISTRATION SETS 15</p> <p style="padding-left: 20px;">Pump Illustrations and Features..... 15</p> <p style="padding-left: 20px;">Disposable Administration Set Illustrations and Features 17</p> <p style="padding-left: 20px;">Preparing Medication for Infusion/Changing IV Bags..... 18</p> <p style="padding-left: 20px;">Opening and Closing the Pump Door 20</p> <p style="padding-left: 20px;">Choosing and Installing the Moog Curlin Infusion Administration Set 22</p> <p style="padding-left: 20px;">Gravity Priming Set and Filter 22</p> <p style="padding-left: 20px;">Steps in Installing Administration Set into Moog Curlin Infusion Pumps 23</p> <p style="padding-left: 20px;">Up Stream Occlusion Alarm Feature 24</p> <p style="padding-left: 20px;">Installing the Batteries and Using External Power 25</p> <p style="padding-left: 20px;">Battery Replacement, Alternate battery door 26</p> <p style="padding-left: 20px;">External Power Sources 28</p> <p style="padding-left: 20px;">AC Adaptor/Charger 34</p> <p style="padding-left: 20px;">Bolus Cord Use 34</p> <p style="padding-left: 20px;">Bolus Cord Use 35</p>	<p>LEARNING PUMP FEATURES..... 36</p> <p style="padding-left: 20px;">Keypad Function..... 37</p> <p style="padding-left: 20px;">Description of the Info-On-Demand (IOD) Feature (Optional) of the Moog Curlin Infusion PainSmart™ IOD Pump..... 38</p> <p style="padding-left: 20px;">Info-On-Demand (IOD) Key Functions 39</p> <p style="padding-left: 20px;">Description of the Custom Features 41</p> <p style="padding-left: 20px;">Description of the Custom Features 42</p> <p style="padding-left: 20px;">LED Light Indicators 43</p> <p style="padding-left: 20px;">Audio Indicator 43</p> <p style="padding-left: 20px;">Display Screen..... 44</p> <p>BASICS OF PROGRAMMING..... 45</p> <p style="padding-left: 20px;">Types of Display Screens 45</p> <p style="padding-left: 40px;">Sample of an Action Field Screen..... 45</p> <p style="padding-left: 40px;">Sample of a Selection List Field..... 45</p> <p style="padding-left: 40px;">Sample of a Data Entry Screen..... 46</p> <p style="padding-left: 40px;">Sample of a Run Screen 46</p> <p style="padding-left: 40px;">Sample of User Notification Screen..... 46</p> <p style="padding-left: 20px;">Using “Help” 47</p> <p style="padding-left: 20px;">Starting the Pump 47</p> <p style="padding-left: 40px;">Welcome Screen 47</p> <p style="padding-left: 40px;">Power Status Screen 48</p> <p style="padding-left: 40px;">Preventive Maintenance Screen..... 48</p> <p style="padding-left: 40px;">Select Program or BioMed Setup Screen..... 48</p> <p style="padding-left: 20px;">Access Code..... 49</p> <p style="padding-left: 40px;">Clinician Access Code Screen 49</p> <p style="padding-left: 20px;">BioMed Setup 49</p> <p style="padding-left: 40px;">BioMed Setup Menu 49</p> <p style="padding-left: 40px;">Enable Therapy Menu..... 51</p> <p style="padding-left: 20px;">Patient History Log..... 52</p>
---	---

TABLE OF CONTENTS

<p>History Event Log 53</p> <p>Clearing the History Log..... 54</p> <p>Clearing Patient Information 54</p> <p>Changing Date and Time 55</p> <p style="padding-left: 20px;">Change Date and Time Screen..... 55</p> <p>Program 56</p> <p style="padding-left: 20px;">Program/BioMed Setup Menu..... 56</p> <p style="padding-left: 20px;">Resume/Repeat Rx/New Program Menu 56</p> <p>Resuming a Therapy..... 57</p> <p>Repeating a Pre-Programmed Therapy.. 57</p> <p>How to Go to New Program..... 58</p> <p>Entering or Changing Data Fields..... 58</p> <p>PROGRAMMING A PAINSMART PUMP WITH PROTOCOL LIBRARY SAFETY SYSTEM (PLSS) VERSION 2 PROGRAM 59</p> <p style="padding-left: 20px;">Programming a Pump with a Protocol Library 60</p> <p style="padding-left: 40px;">Resume/Repeat Rx/New Program Menu 60</p> <p style="padding-left: 20px;">Programming a New Library Therapy ... 60</p> <p style="padding-left: 20px;">Resuming a Library Therapy 61</p> <p style="padding-left: 20px;">Repeating a Pre-Programmed Library Therapy 62</p> <p>PCA THERAPY 63</p> <p style="padding-left: 20px;">Prescription Menus 63</p> <p style="padding-left: 40px;">PCA Pre-Prescription Menu Screen 63</p> <p style="padding-left: 40px;">Administration Routes..... 64</p> <p style="padding-left: 40px;">PCA medLMTS™ Setup Screen 65</p> <p style="padding-left: 40px;">PCA Prescription Menu..... 66</p> <p style="padding-left: 40px;">Run Options Screen 67</p>	<p>Prime 67</p> <p style="padding-left: 20px;">Prime Direction Screen 68</p> <p>Options 69</p> <p style="padding-left: 20px;">PCA Options Menu 69</p> <p style="padding-left: 20px;">Clinician Dose Menu..... 70</p> <p style="padding-left: 20px;">Clinician Dose Run Screen 70</p> <p style="padding-left: 20px;">Shift Totals Screens 71</p> <p style="padding-left: 20px;">Hourly Totals Screen..... 71</p> <p style="padding-left: 20px;">Clear Hourly Totals Screen 72</p> <p style="padding-left: 20px;">PCA Titrate medLMTS™ Screen..... 72</p> <p style="padding-left: 20px;">Air-In-Line Sensor Off Message Screen 73</p> <p style="padding-left: 20px;">Pump Will Sense 2mL Alert Screen 74</p> <p>Reviewing or Changing the Program 74</p> <p>Starting the Infusion 75</p> <p style="padding-left: 20px;">PCA Run Screen..... 75</p> <p style="padding-left: 20px;">PCA Information Screens 76</p> <p>Interrupting an Infusion 76</p> <p style="padding-left: 20px;">Pause Menu Screen 76</p> <p>Resuming the Current Container 76</p> <p style="padding-left: 20px;">Run Options Screen 76</p> <p>Hanging a New Container..... 77</p> <p>Entering a New Program 78</p> <p>Infusion Complete 78</p> <p style="padding-left: 20px;">PCA Infusion Complete 78</p> <p>Stopping the Infusion 79</p> <p style="padding-left: 20px;">Pause Menu Screen 79</p> <p>TROUBLESHOOTING 81</p> <p style="padding-left: 20px;">Alerts, Alarms, and Error Codes 81</p> <p>ACCESSORIES..... 103</p> <p style="padding-left: 20px;">Detachable Pole Clamps..... 103</p> <p style="padding-left: 20px;">Remote Bolus Cord (340-2005) 104</p> <p style="padding-left: 20px;">Lockable Safety Shells 105</p> <p style="padding-left: 20px;">Pump Holster (340-0111) 106</p> <p style="padding-left: 20px;">Keypad Covers 107</p>
--	---

TABLE OF CONTENTS

**CLEANING,
ENVIRONMENTAL
CONDITIONS, AND
MAINTENANCE 108**

- Cleaning..... 108**
- Transport and Storage 109**
- Operating Environment 109**
- Maintenance..... 109**
- Limited Warranty..... 109**
- Procedure for Checking Pumps Between
Patients 111**

**TECHNICAL
SPECIFICATIONS..... 115**

**CLINICIAN
INFORMATION AND
ACCESS CODE..... 125**

- Clinician Access Code..... 125**

**PAINSMART™ IOD
CATALOG NUMBERS..... 131**

TABLE OF FIGURES

<p>Figure 2.1 Moog Curlin Infusion Ambulatory Pump – Front, Top, and Left View 15</p> <p>Figure 2.2 Moog Curlin Infusion Ambulatory Pump – Back, Bottom, and Right View..... 16</p> <p>Figure 2.3 Sample of Moog Curlin Infusion Administration Sets..... 17</p> <p>Figure 2.4 Spiking the Fluid Container, Gravity Priming the Set, and Using the Slide Clamp to Close the Tubing 18</p> <p>Figure 2.5 Moog Curlin Infusion Administration Set Integral Flow-Stop with Breakaway Tab 19</p> <p>Figure 2.6 Intentionally Opening the Integral Flow-Stop 19</p> <p>Figure 2.7 Opening the Pump Door 20</p> <p>Figure 2.8 Closing the Pump Door 21</p> <p>Figure 2.9 Proper Installation of the Moog Curlin Infusion Administration Set into the Pump 23</p> <p>Figure 2.10 Top Cutaway View of the Moog Curlin Infusion Pump with Moog Curlin Infusion Administration Set in Proper Installation Position..... 24</p> <p>Figure 2.11..... 26</p> <p>Figure 2.12 Universal AC Adaptor 34</p> <p>Figure 2.13 Attaching and Removing the Remote Bolus Cord..... 35</p> <p>Figure 3.1 Moog Curlin Pump Features..... 36</p> <p>Figure 3.2 Painsmart™ IOD Keypad with Info-On-Demand Feature 38</p> <p>Figure 3.3 Sample of Display Screen..... 44</p> <p>Figure 4.1 History Event Log 53</p>	<p>Figure 5.1 PCA Administration Route Default Settings 64</p> <p>Figure 8.1 Detachable Pole Clamp..... 103</p> <p>Figure 8.2 Remote Bolus Cord..... 104</p> <p>Figure 8.3 Safety Shells 105</p> <p>Figure 8.4 Pole Clamp and Safety Shell Installation..... 106</p> <p>Figure 8.5 Pump Holster..... 106</p> <p>Figure 8.6 Keypad Covers 107</p>
---	--

Introduction

*Let us first review the delivery modes and routes, indications for use, special features, regulatory agency approvals and warnings, cautions and notices relating to the **Moog Curlin Infusion Pumps**.*

Let's begin by introducing you to the **Moog Curlin Infusion** pump, an easy-to-use, ambulatory or pole mounted infusion device designed to meet the needs of the hospital or alternate site patient. It operates accurately in any position, has a low rate resolution of 2 microliters, and its small, compact, lightweight design allows mobility for ambulatory patients.

The **Moog Curlin Infusion** pump can be carried in any of the four convenient carryall soft-packs, pole mounted, placed into the locked "safety shells," or set on a suitable surface for use.

Delivery Mode and Routes

PainSmart™ IOD is a **PCA or Patient Controlled Analgesia** pump designed for therapies that require a continuous rate of infusion, patient-controlled demand boluses, or both. Three administration routes, namely intravenous (IV), epidural (EPI) and subcutaneous (SQ); and three units of delivery, namely milligrams (mg), micrograms (mcg) and milliliters (mL) are available. With the help of a software program purchased from **Moog**, an institution can configure the administration route to be fixed as IV, EPI or SQ. If any administration route is selected as "fixed," it is the only route available to the user (other routes will not be displayed) and cannot be re-enabled in the BioMed Setup menu. Similarly, the units of delivery can be fixed as mg, mcg or mL. If any unit of delivery is selected as "fixed," it cannot be modified by the clinician/user in the BioMed Setup menu.

Indications for Use

The **Moog Curlin** infusion pump can be used for intravenous, intra-arterial, epidural, subcutaneous, or enteral infusions. Any therapy should be overseen by a physician or a certified, licensed healthcare practitioner. The infusion pump can provide therapy to patients/users who are ambulatory and needed an alternative to receiving their medication in a restricted manner (hospital or clinic). Typically, these patients are capable of being given instruction for performing basic tasks in operation the pump and maintaining medical care for themselves, or are assisted in these tasks by having a caregiver closely by, or living with them. All patients and caregivers must be instructed in the use of the pump by a qualified clinician and demonstrate an adequate level of proficiency in the use of the pump.

¹ Moog cannot guarantee the $\pm 5\%$ accuracy claim when using syringes

Special Features of the Pump

- Small, accurate, ambulatory, volumetric infusion pump that provides reliable and safe delivery of infusion therapies.
- The optional Info-On-Demand feature of the Moog Curlin Infusion PainSmart™ IOD pump safely provides additional information to the user when the pump is in the RUN mode.
- Customized Maximum Basal Rate Limit.
- Customized Maximum Bolus, Clinician, and Load Dose Limits.
- Customized Lock Level setting.
- Large screen with Tallman Lettering.
- Larger font, single information display.
- Patient side (downstream) “Line Pressure” displayed.
- medLMTS™ features.
- PCA dose and medLMTS™ schedules that can be maintained on Repeat.
- Pump will not permit the user to enter any programming value that is outside of its predetermined default range, or further restricted through medLMTS™.
- Ability, at the institution level, to configure the pump for specific administration route or units of measure:
 - Units (Factory, mL, mg, mcg, mL fixed, mg fixed or mcg fixed)
 - Route (Intravenous, Epidural, Subcutaneous, Intravenous fixed, Epidural fixed or Subcutaneous fixed)
- Patient and therapy-specific programming features via the **Moog Curlin Infusion** BIOMED SETUP and Options Menus (when not limited by the institution).
- Selection by user from three units of delivery: milliliters, milligrams, and micrograms (when not limited by the institution).
- Choice of five or nine digit Clinician Access Code.
- Maintenance Due Date that is automatically set, the first time, after 12 hours of use.
- Shift Totals that can be greater than 24 hours.
- Hourly Totals.
- Automatic scrolling of the programmed prescription with “quick-repeat” function.
- Cost effective, safe and easy-to-load disposable **Moog Curlin Infusion** administration sets featuring a unique, spring-activated, self-clamping, set-based Integral Flow-Stop device that automatically clamps the tubing when the door of the pump is opened and prevents inadvertent fluid flow.
- User-friendly, easy-to-teach programming that shortens staff in-service time and patient teaching time.
- Help screens and display messages.
- Three tamper-resistant lock settings to assist in maintaining patient compliance and safety.

- Retention of programmed infusion settings until cleared by the clinician, thus eliminating the need to reprogram before each use.
- Mandatory requirement of two independent key press actions before a running pump can be turned off, thus minimizing the accidental interruption of a therapy in progress.
- Powered by two readily available, cost-effective C-cell alkaline batteries.
- Attractive yet robust design that is impact resistant and water resistant.
- Audio alarms that can be adjusted from 1 (very quiet) to 9 (loudest) to meet specific patient and clinical setting needs but that cannot be totally disabled.
- Four sizes of convenient carry packs to assist the ambulatory patient in maintaining independence of lifestyle.
- Retained memory features that allow the pump to easily resume a therapy exactly from where it left off when it is interrupted before completion or to repeat a therapy using the same programmed prescription.
- Compact, lockable safety shells that provide additional security when needed and that are designed to be free standing, pole mounted, or placed in the convenient, soft carry case.
- Backlit illumination for display screen. Backlight remains on continuously if AC Adaptor is in use.
- Integral Up as well as Down Occlusion alarms to notify user if an occlusion is present on either side of the pumping chamber.
- Integral High Upstream pressure alarm to notify user of excessive upstream pressure.
- Integral Air-In-Line alarm to notify user of presence of air in the tubing.
- Adjustable Down Occlusion settings of “High” and “Low” to customize the pump’s down pressure requirements.

Regulatory Agency Approvals



INFUSION PUMP
 WITH RESPECT TO ELECTRIC SHOCK, FIRE
 AND MECHANICAL HAZARDS ONLY
 IN ACCORDANCE WITH UL60601-1/CAN/CSA C22.2 NO.601.1
 70TK

- Underwriters Laboratories has evaluated the Moog Curlin 6000 Infusion Pump with AC Adapters to EN 60601-1 and CSA C22.2 No. 601-1 for General Standards of Safety for Medical Equipment and found the Moog Curlin Infusion Pump to be compliant.
- Underwriters Laboratories has evaluated the Moog Curlin 6000 Infusion Pumps with accessory equipment’s Battery Pack 360-2030 and the International Curlin 6000 AC Adapters to EN 60601-2-24. Particular requirements for safety of infusion pumps and controllers and they were found to be compliant.
- Underwriters Laboratories has evaluated the Moog Curlin Infusion Pump and the Curlin 6000 AC Adapter for Electromagnetic Compatibility, to regulations EN 60601-1 and EN 60601-2-24 and both were found to be compliant.

**IMPORTANT
INFORMATION**

The indicator shown at the left appears throughout this manual to emphasize important information in the operation of the Moog Curlin Infusion pump. Please read these sections carefully.

Warnings, Cautions, Notices

EXPLANATION FOR SYMBOLS on the **Moog Curlin Infusion** pump with the Classified UL 60601-1 and CSA C22.2 No. 601-1 Label.

The meanings for the symbols on the pump are as follows:

 Attention, consult ACCOMPANYING DOCUMENTS.

 Type CF Equipment

IPX1 Protected against dripping water.



Separate collection of electrical and electronic equipment and batteries/accumulators.
Please do not dispose of this pump/accumulator in the regular bin.



INFUSION PUMP
WITH RESPECT TO ELECTRIC SHOCK, FIRE
AND MECHANICAL HAZARDS ONLY
IN ACCORDANCE WITH UL60601-1/CAN/CSA C22.2 NO. 601.1
70TK

INTERNALLY POWERED OR FOR USE WITH Curlin 6000 AC ADAPTERS.

DEFIBRILLATION PROOF TYPE CF APPLIED PARTS

EQUIPMENT PROTECTED AGAINST DRIPPING WATER, IPX1

EQUIPMENT NOT SUITABLE FOR USE IN THE PRESENCE OF A FLAMMABLE ANESTHETIC MIXTURE WITH AIR OR WITH OXYGEN OR NITROUS OXIDE

MODE OF OPERATION CONTINUOUS

WARNINGS

- **In a life sustaining situation** it is recommended that your Curlin Infusion pump use the AC Adaptor and have a back-up pump available. Also provide an extra set of C-cell batteries in addition to the batteries that are installed in the pumps.

- User should be aware that the error in delivered drug volume may exceed $\pm 5\%$ when a syringe is used with the Curlin Infusion pump.

A mechanical problem, known as “stiction,” may occur when the syringe is operated at low plunger speeds. The friction between the syringe plunger and the barrel causes the plunger to stick, then moves forward in a jerking motion, and the fluid will be delivered as a series of boluses. This effect will cause variations larger than 5% in the delivered volume. The fit between the syringe plunger and the barrel may vary from batch to batch and, consequently, the stiction effect may also vary.

Due to this potential error, the delivery of powerful drugs with short half lives, such as catecholamines is not recommended.

- Prevent direct exposure to radiations. Secure an essential infusion pump outside of the radiation field using extension tubing if required.
- Use only **Moog Curlin Infusion** administration sets in your **Moog Curlin Infusion** pump.
- Use of nonproprietary administration sets may alter accuracy in delivery of fluids and could result in over or under infusions, leading to possible patient injury or death.
- Visually inspect the pump, pumping chamber and administration set before use. Do not use any pump or administration set that appears to be damaged or tampered with or if there is any indication of improper function.
- Do not use this pump with a pressure cuff applied to the IV bag or medication reservoir bag, and do not unduly squeeze or compress the bag during a running infusion.
- Remove all air from the administration set and IV bag or reservoir before connecting it to a patient’s access site.
- Damage to the pump due to dropping or impact while the door is open can cause intermittent free flow conditions and loss of pump accuracy, but may not be visible through inspection. Volumetric testing is the only method to confirm proper function.

NOTE: Anti-siphon Valve (ASV) administration sets can be used to provide additional free-flow protection.

Note: This procedure does not replace the recommended annual preventive maintenance. The pump should receive preventive maintenance by a qualified technician at least annually.

- Do not subject the pump to dropping or hitting against a hard surface. If at any time the pump is dropped or hit, the pump must be checked for volumetric accuracy prior to reuse. The pump can only be brought back into service if the volumetric accuracy test passes per the user manual. If the pump fails volumetric accuracy it must be returned to Moog Medical Devices Group for evaluation.

- Do NOT prime the administration set while it is connected to the patient's access device. Doing so could result in overdosing the patient and could cause injury or death.
- Do not attempt to open the pump's housing. All service problems should be referred to an appropriate service technician.
- **Danger:** Risk of explosion if used in the presence of flammable anesthetic or explosive gasses.
- The CURLIN PainSmart is NOT safe for use in an MRI environment. The CURLIN PainSmart should not enter the MRI scanner room. The device presents a projectile hazard.

CAUTIONS

- U.S. federal law restricts this device to sale by or on the order of a physician or other licensed practitioner.
- Keep the pumping surfaces clean, dry, and free of fluid spillage at all times.
- This pump is fluid resistant and can withstand fluid spillage. It is **not**, however, designed for total submersion as moisture buildup within the case could cause damage to the operating components. Do not use the pump in the shower, sauna, or steam bath, and do not position the pump where it could accidentally be dropped into a container of fluid (e.g., basin, tub, or toilet). Avoid fluid contact with the power port and data port of the pump.
- Do not try to insert foreign objects into any of the pump connectors, as such objects may damage the pump.
- Use only **Moog Curlin Infusion** external power sources to power the **Moog Curlin Infusion** pump. Using other power sources may result in circuitry or microprocessor damage.
- When using the AC Adaptor, connect the plug only into a *grounded* AC outlet.
- Use only non-rigid, non-vented IV fluid containers unless an air vent adaptor is in place and the container is suspended from an IV pole.
- Do not unduly stretch the tubing of the administration set or leave the tubing in the pump for more than twenty-four hours when the pump is not running.
- Use **Moog Curlin Infusion** administration sets with appropriate air-in-line filters any time the Air-In-Line Sensor of the pump is disabled.
- If any signs or symptoms of infiltration or inflammation are noted at the infusion site, stop the infusion and report it to the appropriate healthcare provider.
- Always use the slide clamp on the administration set as an additional precaution to occlude the tubing before opening the door of the pump.
- Avoid leaving tubing and cords where infants, children, or those deemed at high risk for medical line entanglement, can become entangled. Be aware that if these items become wrapped around a patient's neck, there is an increased risk of strangulation or death. Caregivers of patients who are at risk for entanglement should discuss with their health care provider how to properly manage their lines and properly monitor patients based on their needs while in use.

NOTICES

- The **Moog Curlin Infusion** pump is not intended for the administration of blood or cellular blood products.
- Dispose of all used administration sets in accordance with all applicable regulatory and institutional policies.
- Teach users to check all tubing sites for proper aseptic connections and to check the administration sets for air leaks before and during the infusion.
- To minimize the potential hazard of air bubble formation or “out-gassing,” administer all medications at the proper temperatures, and remove medications from refrigerators as specified by the healthcare provider or pharmaceutical manufacturer.
- To avoid potential fire hazard, do not use the pump near flammable anesthetics, explosive gases or in an oxygen rich environment such as Hyperbaric Oxygen Therapy. Note: Use with supplementary oxygen and ventilation is allowed.
- Follow local governing ordinances and recycling plans regarding disposal or recycling of device components. When the C-cell batteries are to be discarded, do not incinerate them. Dispose of all used administration sets in accordance with all applicable regulatory and institutional policies and directions.
- Adhere to any warnings, precautions, or recommendations stated by drug manufacturers regarding the use of infusion pumps and disposable administration sets in the administration of their specific products.
- Administer all drugs selected for epidural administration in accordance with the indications included in the manufacturer’s package insert accompanying the drugs.
- Note that the administration of medications into the epidural space is limited to delivery via specially designed indwelling catheters inserted by a qualified physician. Any patients receiving epidural infusions should be managed and monitored by medical professionals familiar with epidural administrations and their clinical management. **Moog** offers administration sets specifically designed for epidural infusions with 0.22 micron filters, no injection ports, and yellow striping to clearly identify the set for epidural use. Any administration set being used for epidural infusions should be clearly labeled as such.
- Clean the pump, remote bolus cord, AC adaptor, and battery pack with a soft, clean cloth dampened in any of the following:
 1. Warm soapy water (do not submerge)
 2. Isopropyl alcohol
 3. Household bleach, diluted 9:1 with water
 4. Commercial disinfectantWhen clean, dry pump and other items with a soft, clean, dry cloth.
- The soft carry packs are intended for single patient use. They may be cleaned in the gentle cycle of a washing machine using cold water, no chlorine bleach, and line dried. (They cannot be dried in a clothes dryer.)

- The Bolus/Data Connector is to be used by the patient only for the connection of the bolus cord with the remote switch. Other accessory equipment connected to this digital interface must be certified to the respective IEC/EN standards (i.e. IEC 950 for data processing equipment and EN 60601-1 for medical equipment). Furthermore, all configurations shall comply with the system standard EN 60601-1. Anyone who connects additional equipment to the signal input part or signal output part configures a medical system, and is therefore, responsible that the system complies with the requirements of the system standard EN 60601-1. If in doubt, consult the technical services department or your local **Moog** representative.
- The **Moog Curlin Infusion** pump has been tested and found to comply with the European Standard EN 60601-1-2:1993 and EN 60601-2-24:1994. These limits are designed to provide reasonable protection against harmful interference in a typical medical installation.
- This equipment generates, uses, and can radiate radio frequency energy and, if not installed and used in accordance with the instructions, may cause harmful interference to other devices in the vicinity. However, there is no guarantee that interference will not occur in a particular installation. If this equipment does cause harmful interference to other devices, which can be determined by turning the equipment off and on, the user is encouraged to try to correct the interference by one of more of the following measures:
 1. Reorient or relocate the receiving device.
 2. Increase the separation between the equipment.
 3. Connect the equipment into an outlet on a circuit different from that to which the other device(s) are connected.
 4. Consult the manufacturer or field service technician for help.

Note: For information regarding the clinician access code, read the chapter entitled, “Clinician Information and Access Code.” When entered correctly, the access code allows a user to change the lock settings of the pump and thereby change the settings of the pump.

**IMPORTANT
INFORMATION**

Because the chapter entitled “Clinician Information and Access Code” contains access code information, the entire chapter should be removed before initial patient teaching and should not be left in the manual while in the patient setting. Doing so could jeopardize the security levels intended only for clinician use and access.

List of Abbreviations

#BOLS/hr	=	Number of bolus doses per hour In patient controlled analgesia the number of boluses allowed per hour 0-15
Δ RATE	=	Amount rate may be changed
Δ TIME	=	Interval until rate may be changed
AMT	=	Amount
AMT	=	Amount to be infused
TBI		
BA	=	Bolus Attempted Options hourly screen shows amount of bolus doses attempted
BASL	=	Basal Basal rate or continuous basal infusion maximum varies by route of infusion, intravenous, epidural or subcutaneous
BG	=	Bolus Given Options hourly screen shows amount of bolus doses infused
BOL INT	=	Bolus Interval Allows clinician to enter RX amount of time 0-60 min between patient-activated bolus dosing for pain management
CLIN	=	Clinician Clinician dose is the option to give an additional prescribed dose by a clinician
CLRHRLY	=	Clear Hourly Option to clear hourly totals of amount infused
CONCEN	=	Concentration Concentration is the amount of milligrams or micrograms per milliliter of solution
dd	=	Day To set date enter 2 digit day
DN Occlu	=	Down Occlusion Occlusion pressure in the line between the pump and the patient access site, as a kink in tubing, blockage in access site (infiltration) or clamp on
EPI	=	Epidural To inject anesthetic into the spinal canal
HH:MM	=	Hours and Minutes To set time enter military 24 hour or AM/PM 12 hour
HX	=	History The patient history log is a cumulative record of the last 6,000 events that have occurred in the pump
INF	=	Infusion Fluid or medication pumping into the patient via intravenous, subcutaneous, or epidural routes
IV	=	Intravenous To give fluids or medication directly into the venous circulation via peripheral or central circulation
KVO	=	Keep Vein Open To infuse a very small amount of fluid to keep vein patent
LPRES	=	Line Pressure Shows downstream pressure to patient in millimeter of mercury
MAX	=	Maximum
MCG	=	Microgram
medLMTS™	=	Sets limits for medication being infused
MG	=	Milligram
MIN	=	Minimum Minimum amount of time between patient boluses
mL	=	Milliliter

	A unit of liquid measure 1/1000 of a liter
mm	Month
	To set date enter 2 digit month
MX	= Maximum
	Upper limit of a bolus or patient demand dose, or infusion rate
OPT	= Options
	Once prescription is programmed, this key provides customizing features as locking programs from changes, alarm volume, battery level, amount of air detection, adjust occlusion alarm, hourly totals, shift totals, clinician dosing
PCA	= Patient Controlled Analgesia
	Pain control by continuous rate of infusion with options for patient controlled demand boluses
PT	= Patient
	Person receiving infusion
RX	= Prescription
	Written order for medication with instructions of how to administer as time, dose, amount, limits, and route
SENS	= Sensor
	Air-In-Line Sensor will detect the amount of air in the tubing
SQ	= Subcutaneous
	To give fluids or medication just below the skin, also (SC)
VOL	= Volume
	Amount of fluid in intravenous bag, medication reservoir or syringes
yy	= Year
	To set date enter 2 digit year

Features of the Pump and Administration Sets

The **Moog Curlin Infusion PainSmart™** and **PainSmart™ IOD** pumps have been designed with the user in mind and have the latest in friendly, simple-to-learn technology to allow fast and easy access to the features of these pumps. With a little introduction and training, an operator will quickly be able to program and use these pumps to deliver the therapies prescribed.

Pump Illustrations and Features

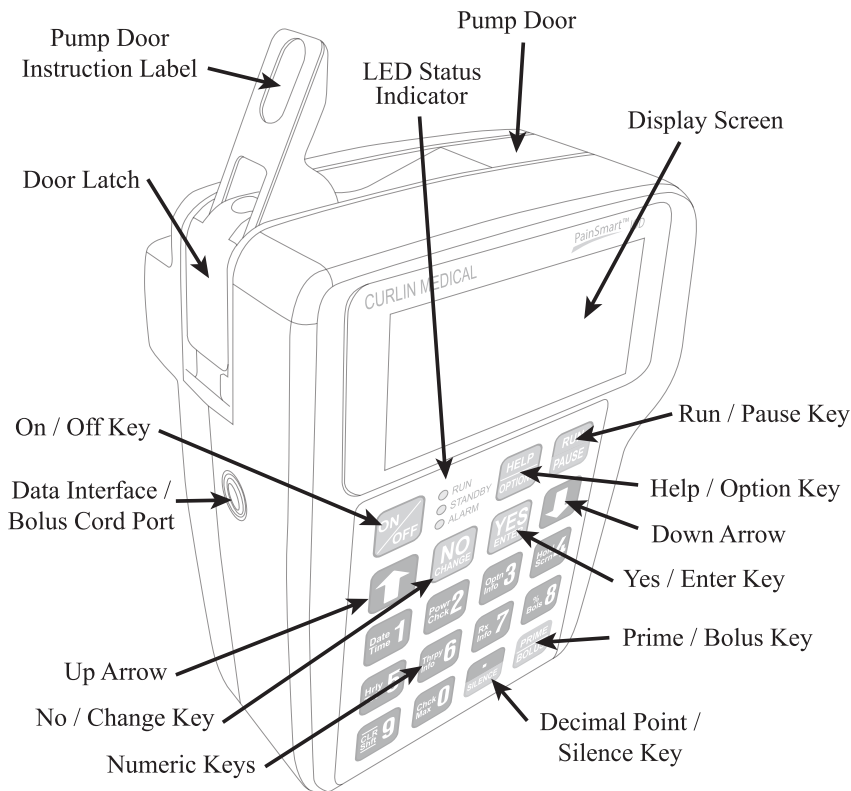

Figure 2.1 Moog Curlin Infusion Ambulatory Pump – Front, Top, and Left View

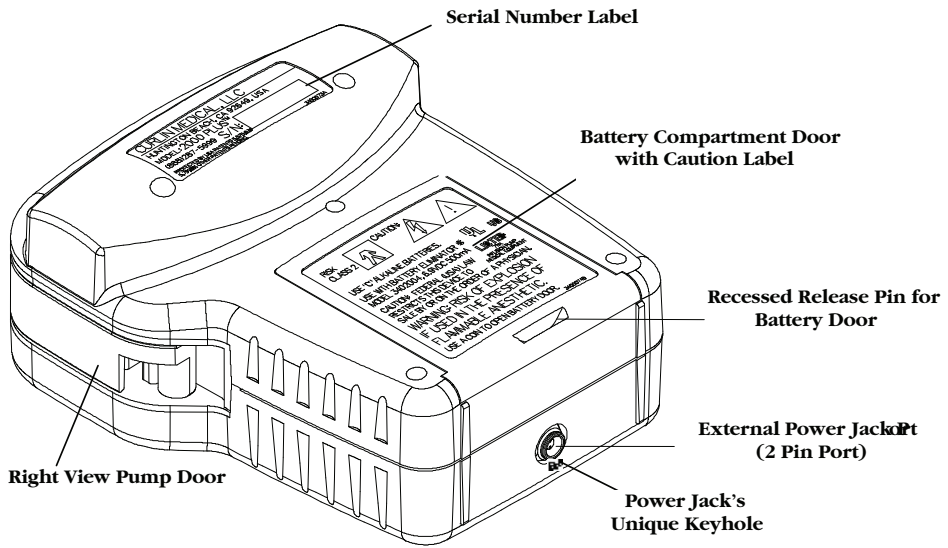
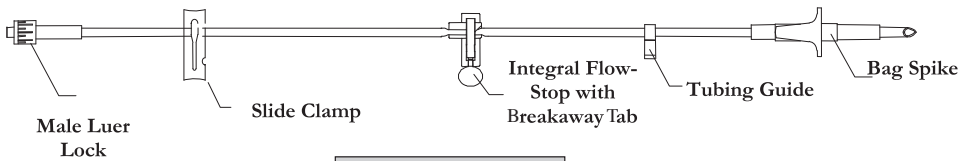

Figure 2.2 Moog Curlin Infusion Ambulatory Pump – Back, Bottom, and Right View

Disposable Administration Set Illustrations and Features



These drawings are
NOT to scale.

Note: An important feature of the Moog Curlin Medical administration set is the unique design of the set-based Integral Flow-Stop. When the set is new, the Integral Flow-Stop has a breakaway tab that keeps the Integral Flow-Stop open and allows the tubing to be gravity primed. When you are ready to load the administration set into the pump, remove this tab, and the Integral Flow-Stop will automatically clamp the tubing. The Moog Curlin Medical Integral Flow-Stop prevents inadvertent flow of medication to the patient whenever the door of the pump is opened because the Integral Flow-Stop automatically reacts to clamp the tubing. The Integral Flow-Stop can, however, be opened after the tab is broken away by intentionally squeezing down on the movable spring action section of the Integral Flow-Stop. See Figure 2.6 for an illustration of how to intentionally open the Integral Flow-Stop. For a complete listing of all available administration sets, see the Moog Curlin Medical Product Catalog.

Note: Administration sets with anti-siphon valve (ASV) protection can also be used for additional free-flow protection.

CAUTION: USE ONLY MOOG CURLIN INFUSION ADMINISTRATION SETS WITH THIS PUMP

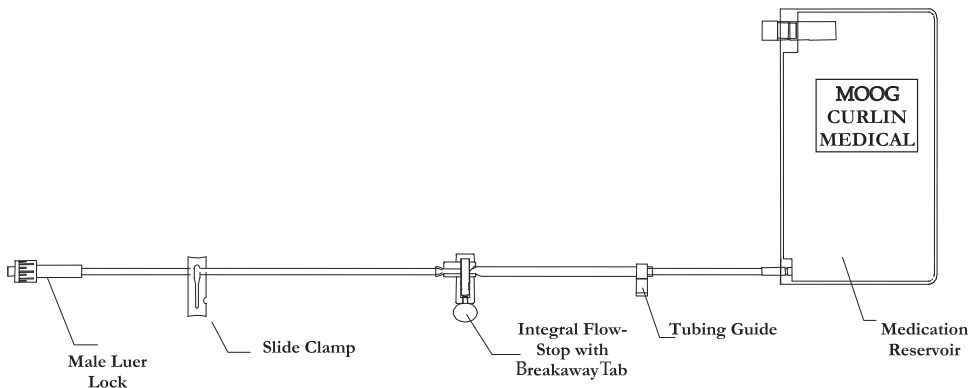

Figure 2.3 Sample of Curlin Infusion Administration Sets

Preparing Medication for Infusion/Changing IV Bags

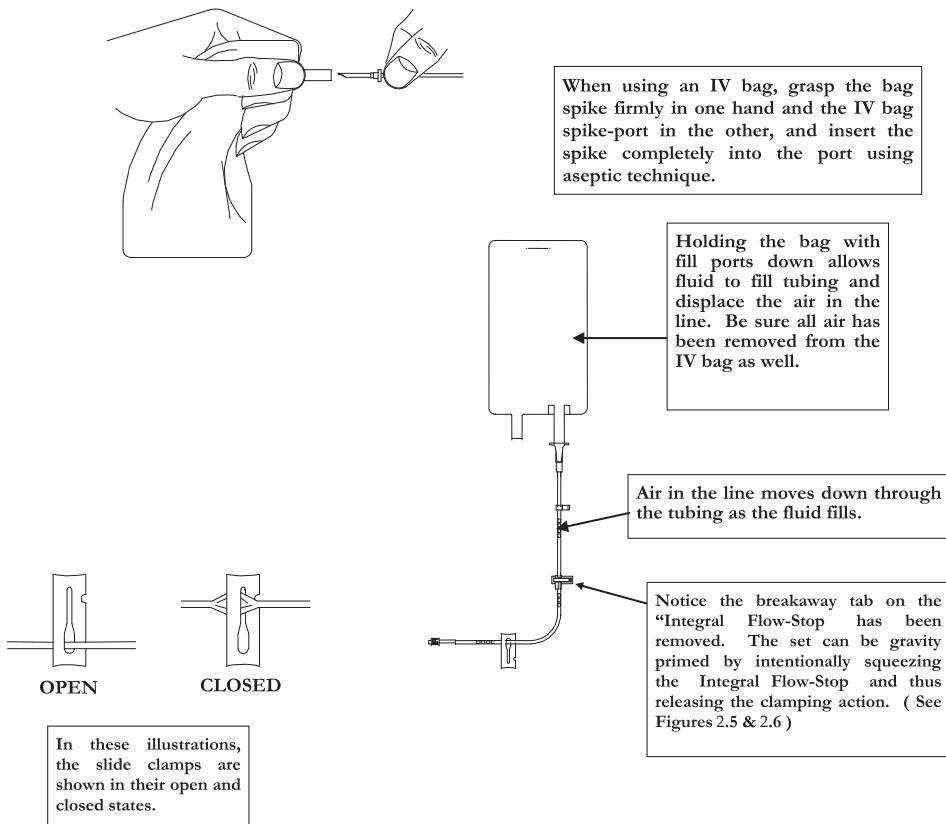

Figure 2.4 Spiking the Fluid Container, Gravity Priming the Set, and Using the Slide Clamp to Close the Tubing

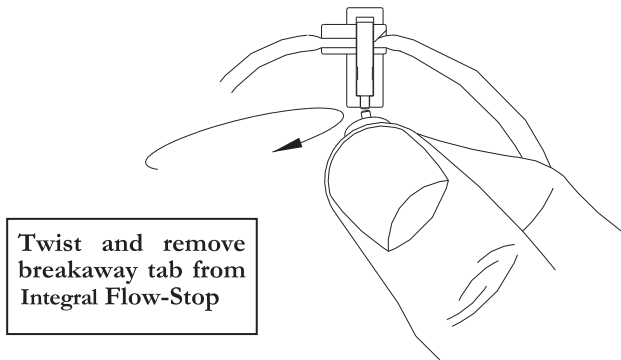

Figure 2.5 Curlin Infusion Administration Set Integral Flow-Stop with Breakaway Tab

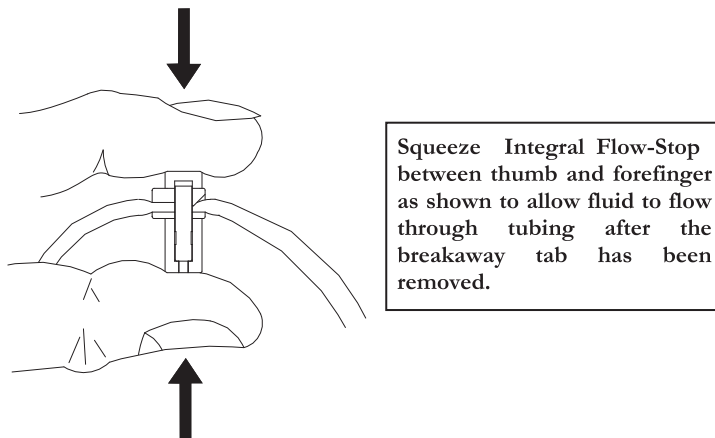
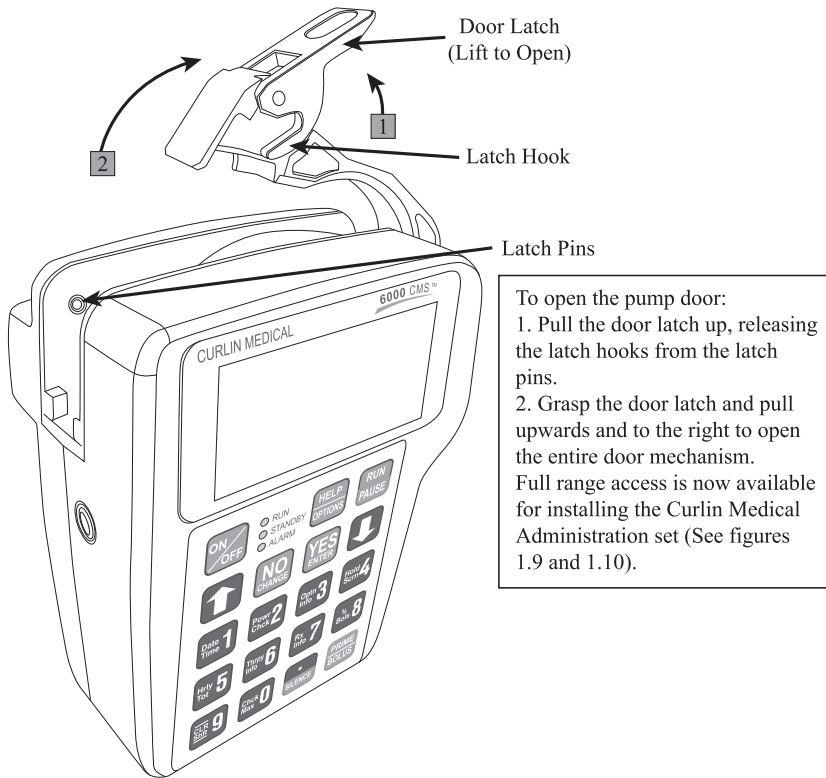

Figure 2.6 Intentionally Opening the Integral Flow-Stop

Opening and Closing the Pump Door



The pump door, located on the top of the **Moog Curlin Infusion** pump, has a sturdy “over center” latching mechanism, which assists in securely closing the door. Review the following illustrations:

Figure 2.7 Opening the Pump Door

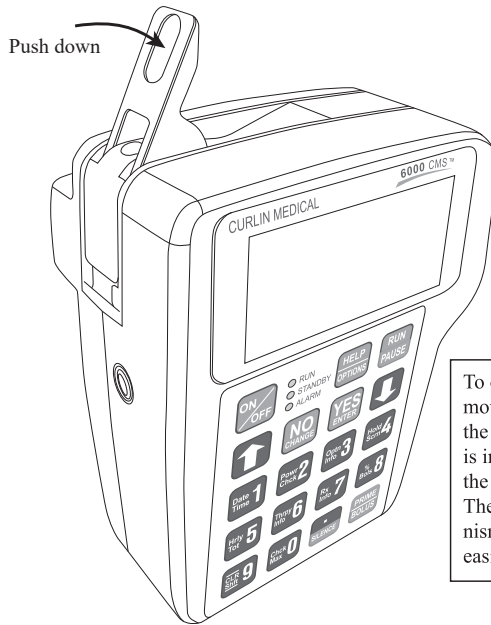

To close the pump door properly, move the entire door assembly to the left and push downward until it is in its closed position. Then push the door latch down until it locks. The “over-center” latching mechanism assures that the door closes easily and securely.

Figure 2.8 Closing the Pump Door

Choosing and Installing the Moog Curlin Infusion Administration Set

A number of distinctively designed **Moog Curlin Infusion** administration sets are available to deliver each prescription accurately. (See **Moog Curlin Infusion Product Catalog**.) Each set is designed to meet the requirements of specific therapies. Therefore, if a basic bag-spike set or a set with a medication reservoir is needed, with or without air eliminating filters, etc., there are several configurations from which to choose. Follow the healthcare provider's protocols for preparing the medication and the administration set before loading the set into the pump, remembering the following basic rules:

1. Examine the packaging and the administration set before use to assure the package integrity.
Do not use the set if the protective caps are dislodged or if the package integrity is breached, as fluid path sterility cannot be guaranteed under those circumstances.
2. Notice that there is an instructional insert included in the administration set package. This insert includes written and graphic instructions for proper installation of the administration set into the pump. It also lists the "fill volume" of the administration set. Allow for the amount of the fill volume when determining the final IV bag volume.

Gravity Priming Set and Filter

1. To gravity prime the administration set, twist and remove the breakaway tab from the Integral Flow-Stop, then spike the IV bag. Squeeze the Integral Flow-Stop between your thumb and forefinger to allow fluid to flow through the tubing until all air is removed from the IV bag and administration set (see figures 2.5 and 2.6). Release the Integral Flow-Stop to automatically clamp the tubing.

Note: The set you are using may contain an air-eliminating filter. Depending on the filter type, you may need to hold the filter either upright or inverted while priming it. Refer to the administration set instructions for use for proper orientation of the filter during the priming steps. Clamp immediately after priming is complete to prevent emptying of line.

Note: Administration sets with integral anti-siphon valves cannot be gravity primed.

2. Close the slide clamp on the administration set before the door of the pump is opened.
This step along with the automatic clamping properties of the Integral Flow-Stop prevents inadvertent fluid flow.
3. Use an administration set with an air-eliminating filter whenever the Air-In-Line Sensor is disabled or set to OFF.
4. Follow CDC guidelines or Intravenous Nursing Standards of Practice Guidelines regarding the frequency of changing the administration sets.
5. Use aseptic technique and universal precautions as directed by the policies of your healthcare facility or institution.
6. Use only **Moog Curlin Infusion** administration sets with the **Moog Curlin Infusion** pump.
7. Dispose of administration sets in accordance with all applicable regulatory and institutional policies and directions.

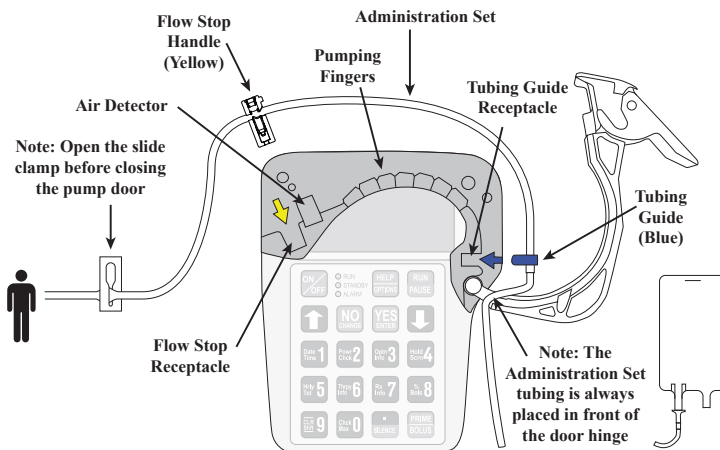
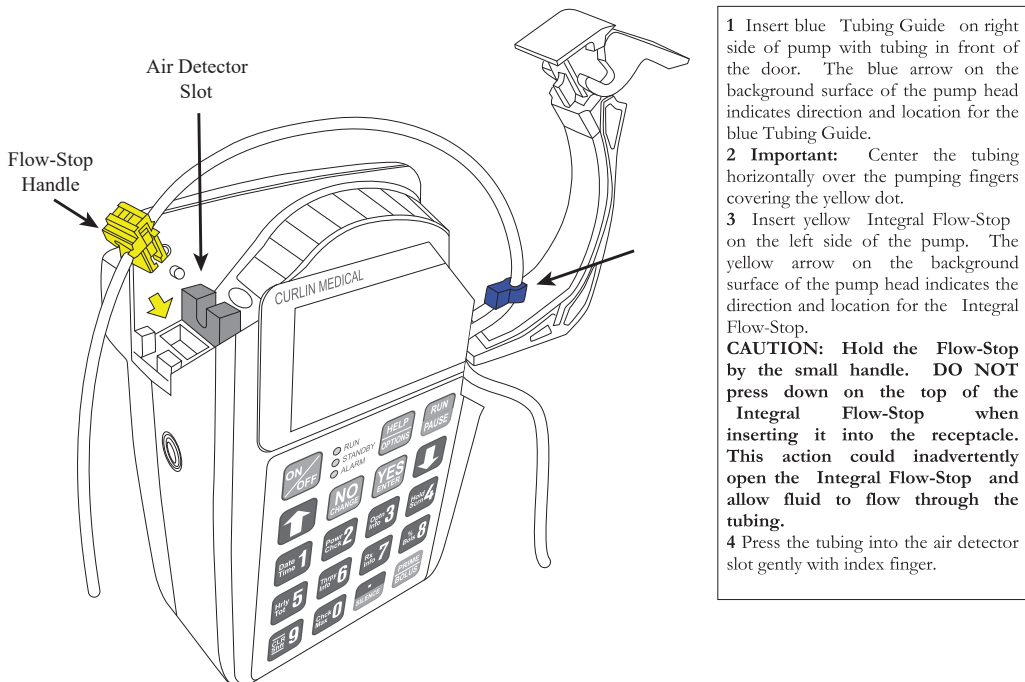

Figure 1.9 shows the Moog Curlin Medical pump with a cut-away of the display screen, allowing you to visualize the receptacles for the small blue Tubing Guide on the right side of the pump and the larger yellow Integral Flow-Stop on the left side of the pump. The arrows, in corresponding colors, are visible on the background surface of the pump head and indicate the proper direction for placing these locators into their receptacles. Also, note that the breakaway tab has been removed from the Integral Flow-Stop, allowing the administration set to be placed into the pump correctly.

Figure 2.9 Proper Installation of the Moog Curlin Infusion Administration Set into the pump

Steps in Installing Administration Set into Moog Curlin Infusion Pumps

1. Fully open the door of the pump.
2. Close the slide clamp on the administration set.
3. Activate the Integral Flow-Stop by twisting and removing the breakaway tab.
4. Insert the blue tubing guide into the receptacle on right side of pump in the direction of the blue arrow, positioning the tubing in **front** of the door hinge.
5. **Center the tubing in the middle of the pumping fingers.**
6. Holding the yellow Integral Flow-Stop by the handle (see Figure 2.9), insert it on an angle into the receptacle on the left side of the pump in the direction of the yellow arrow. **CAUTION: Do not press down on the top of the Integral Flow-Stop when inserting it into the receptacle. This action could inadvertently open the Integral Flow-Stop and allow fluid to flow through the tubing.**
7. Push the tubing slightly into the black Air Detector slot.
8. Open the slide clamp on the administration set.
9. Fully close the door of the pump and latch it securely.
10. If the set is not primed, prime the set according to prime section in the relevant therapy chapter.
11. Attach the primed set to the patient's venous access device per agency protocols.
12. Dispose of used administration sets in accordance with all applicable regulatory and institutional policies and directions.



- 1 Insert blue Tubing Guide on right side of pump with tubing in front of the door. The blue arrow on the background surface of the pump head indicates direction and location for the blue Tubing Guide.
 - 2 **Important:** Center the tubing horizontally over the pumping fingers covering the yellow dot.
 - 3 Insert yellow Integral Flow-Stop on the left side of the pump. The yellow arrow on the background surface of the pump head indicates the direction and location for the Integral Flow-Stop.
- CAUTION:** Hold the Flow-Stop by the small handle. **DO NOT** press down on the top of the Integral Flow-Stop when inserting it into the receptacle. This action could inadvertently open the Integral Flow-Stop and allow fluid to flow through the tubing.
- 4 Press the tubing into the air detector slot gently with index finger.

Figure 2.10 Top Cutaway View of the Moog Curlin Infusion Pump with Moog Curlin Infusion Administration Set in Proper Installation Position

Up Stream Occlusion Alarm Feature

The **Moog Curlin Infusion** pump has an Up Stream Occlusion alarm feature, e.g., it detects low up-stream pressure. This feature notifies you if an occlusion is present between the IV container and the pump. If this alarm occurs, the display will read, “ALARM –UP OCCLUSION,” the alarm will sound, the red LED light will blink, and the infusion will stop. This situation requires that you press the PAUSE key and examine the administration set from the IV container to the pump for potential causes of the occlusion. If a clamp is in place, open or remove it; if the administration set is kinked, straighten it. If indicated, close the slide clamp on the administration set and open the door of the pump to verify that the set is correctly placed. Close the pump’s door and reopen the slide clamp. When ready to begin infusing, select “RESUME” and then press the RUN key.

The pump also detects excessive up stream pressure (pressure on the IV bag). The display will read “ALARM – HIGH UP PRESSURE,” the alarm will sound, the red LED light will blink, and the infusion will stop. If this situation occurs, relieve the source of excessive pressure on the IV bag and when ready to begin infusing, select “RESUME” and then press the RUN key.

Note: The up stream occlusion detection is disabled during priming.

Installing the Batteries and Using External Power

The **Moog Curlin Infusion** pump can be powered solely with the use of two C-cell alkaline batteries installed into the pump as shown in Figure 2.11. C-cell batteries are readily available at most retail facilities that carry alkaline batteries. A second alternative for power is the portable, rechargeable battery pack. The third alternative for power is to use the AC Adaptor, allowing the pump to be connected to any approved, three-prong electrical wall outlet.

The C-cell batteries will last approximately 30 hours at a rate of 125 mL/hour and over 85 hours at rates of 2 mL/hr or less. Factors that influence battery life are the number of times the screen is illuminated with a key press, the viscosity of the fluid being delivered, the age and temperature at which the batteries have been stored. To extend the life of the batteries, patients can use the AC adaptor whenever they are stationary, e.g., at night.

The pump has a “low battery” alert that beeps periodically with a message appearing to tell you when the power is low in the C-cell batteries. This alert gives you a window of time to be sure you have back-up power (e.g. extra batteries, AC adaptor, or a recharged battery pack.) At a continuous infusion rate of 25 mL per hour, you can expect at least a 30 minute warning before your pump can no longer operate due to empty batteries. At higher infusion rates your advance warning will be less.

The user should be taught that whenever the “low battery” alert appears, to pause the therapy, turn the pump off, and to replace both C-cell batteries. Then, turn the pump back on, select resume to continue the therapy.

When the “empty battery” alarm occurs the pump will go into an alarm state and the infusion will stop. If this occurs, turn the pump off, replace both of the C-cell batteries, turn the pump on, and go to the “Resume” function to continue the therapy. All programming information is retained. If the C-cell batteries are empty and you want to connect the AC adaptor to power the pump, turn the pump off first, plug in the AC adaptor and then turn the pump back on.

Note: If you are operating the pump solely on the battery pack or the AC adaptor (no C-cell batteries installed) and the power source is disconnected from the pump, the alarm will sound, the infusion will stop, and the display screen will be blank. Turn the pump off, reconnect the power source, turn the pump on, and resume the therapy. All programmed information is retained. However, as there is no low battery alarm for the external battery pack, the external battery pack should always be used with charged C-cell batteries.

When replacing batteries, **pause any infusion in progress by pressing the PAUSE key, and then turn the pump off**. Replace the batteries, and, when the pump is turned back on, select “RESUME” to continue the therapy from the point at which it was interrupted.

Battery Replacement, Alternate Battery Door

Figure 2.11



- The battery door compartment is located on the back of the pump.
- To open the door, slide the door latch to “open.”
- **Do not use a screwdriver or other sharp objects to open battery compartment door.**
- Slide the battery door down and remove it from the pump.
- If your pump contains a plastic tab between the batteries, pull up on the tab until the batteries can be removed. Otherwise:
 - Using the small coin (penny) pry up and out on the top (+) edge of the battery to cause the battery to pop out.
 - Use the same technique on the second battery.
 - **Do not use a screwdriver or other sharp objects to pry batteries out of the pump.**
- Install two new C-cell batteries by depressing the coil spring with bottom (-) end of the battery and sliding the top of the battery into place.
- Please note: Both positive poles are at the top of the battery compartment. To depress the coil spring, insert the battery at a slight angle.
- Slide the battery door compartment back to its closed position and slide the door latch to “lock.”

<p>To check battery** levels while the pump is running;</p> <ul style="list-style-type: none"> • Press the HELP/OPTIONS key • Scroll down to “PWR Ck?” • Press NO to change to “ON.” • Press YES to view battery level • Press YES to “Accept OPT?” to exit options menu 	<p>CAUTION: If batteries are removed from the bottom (–) end first, damage to the springs in the bottom of the battery case can occur. Damaged springs can create a situation in which the battery overheats. If the battery or the pump becomes excessively warm to the touch, do not attempt to remove the batteries. Set the pump aside and contact your home infusion pharmacy.</p>
<p>* It is recommended to use Duracell® Procell^{®1} Batteries in Moog Curlin Pumps ** C-cell batteries only, this function will not check external battery pump power levels.</p>	

¹ Duracell and Procell are registered trademarks of Proctor & Gamble.

External Power Sources

Rechargeable Lithium Ion (Li-Ion) Battery Pack (360-2030)

Overview

The Li-Ion Battery Pack (pictured below) is designed to be used with 2 fully charged C-cell batteries to power a model 2000, 4000, 6000 or PainSmart™ infusion pump for an extended period of time without being connected to a power outlet. The battery pack allows the user to operate the pump for a minimum of 24 hours (at 125mL/hr) in addition to the run-time supplied by the disposable C-cells in the pump. To ensure an adequate low battery warning period, the battery pack should always be used with 2 fully charged C-cell batteries installed in the pump.



The battery pack provides 5.2V with a capacity of 6000 mA-hrs. It is connected to the same port connector that the AC adaptor uses to power the pump. When the battery pack power is fully exhausted the pump will automatically revert to the internal C-cell batteries. Having new C-cell batteries in the pump is crucial to ensure an adequate low battery warning period and to ensure infusion continuity if the battery pack is accidentally disconnected. The red Low Battery LED on the battery pack will illuminate prior to the external battery running out of power. The pump will provide at least 30 minutes of audible and visual warning prior to the internal C-cell batteries running out power.

The battery pack is recharged by connecting it to an AC adaptor. Fully recharging the battery takes approximately 15 hours. While charging, the LED indicator will be yellow. When the battery is fully charged, the LED will be green. If a fault is encountered in the battery pack the LED will either flash yellow or not illuminate.

Warnings

- The external battery pack should be used with new C-cell batteries in the pump to avoid interruption of the infusion if the cord between the pump and battery pack becomes disconnected and to ensure proper operation of the pump's low battery alarm.
- Do not use this battery pack with the **Moog Curlin 340-2022 (POWDEC AC Adaptor WM10-6.9V)** as the combination may exceed the allowable limits for emitted electromagnetic interference.
- Battery pack cable utilizes an attached cable. This can be a tripping or choking hazard, avoid use that may lead to entanglement around the neck or feet.

Cautions

- This battery pack is fluid resistant, but it is not designed to be water tight. Care should be taken to avoid any unnecessary contact with water or other fluids. Do not use the battery pack where it might fall into water.
- The power gauge located on the pump screen (pictured below) does not reflect the remaining charge in the battery pack. The displayed capacity on the pump will always show empty when a battery pack (with remaining capacity) is attached (see image below):

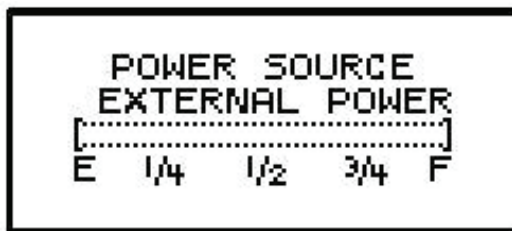

- Refer to the LED indicators on the pump to determine if the battery pack has been fully charged or is in a low battery condition.
- The battery pack should be unplugged from the pump when recharging. The AC adaptor cannot simultaneously power the pump and charge the battery pack. If AC operation is desired, connect the adaptor directly to the pump.

Notice

The Rechargeable Battery Pack DFU is a supplement to the Moog Medical Devices Group Pump User's Manual. All other applicable WARNINGS, CAUTIONS and NOTICES are found in the User's Manual and should be referred to when using this DFU.

Environmental

Storage Temperature -20°C to 65°C; Atmospheric pressure 500hPa to 1060hPa; Humidity 10% to 90%

Operational Temperature 5°C to 40°C; Atmospheric pressure 650hPa to 1020hPa; Humidity 10% to 90%

Directions for Use

Charging the Battery Pack

The Moog Curlin 6000 AC Adaptors can be used to recharge the battery. A fully discharged battery will recharge in less than 15 hours.

Note: Do NOT use Moog Curlin 360-2026 (Globtek GTM341-7.5-800), Moog Curlin 340-2026 (Globtek GTM341-7.5-800), or the Moog Curlin 340-2022 (POWDEC AC Adaptor WM10-6.9V) AC adaptors to recharge the battery.

- If connected, disconnect the battery pack from the pump.
- Connect the AC adaptor to the power port of the battery pack.



- The charge LED light will illuminate yellow if the battery needs to be recharged. See below:

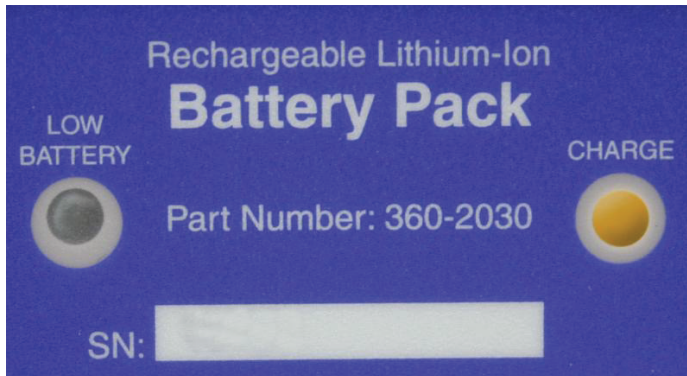

- Charge the battery pack for 15 hours or until the LED turns green indicating the battery is fully charged.

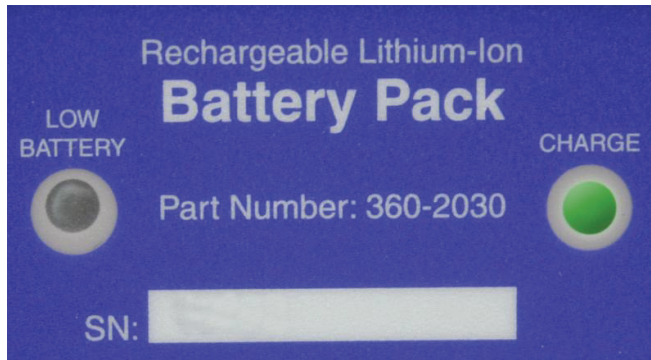

- Disconnect the battery from the AC adaptor.

Note: If there is a fault detected while charging the battery, the LED will either flash yellow or not illuminate. Most faults are due to either the AC adaptor becoming unplugged from the power outlet or the battery pack being at a location where the temperature is not between 5 and 40 degrees celsius. If the fault condition persists, then the battery pack should be returned to Moog Medical Devices Group for replacement of the battery.

Using the Battery Pack to Power the Pump

- Make sure fully charged C-cell batteries are loaded in the pump.
- Connect the battery pack to the AC adaptor port on the pump.



- Operate the pump in the desired infusion mode.

- Do not use the pump's display (see cautions) to predict external battery life.
- When the external battery pack is nearly depleted, the red LED indicator will be illuminated.

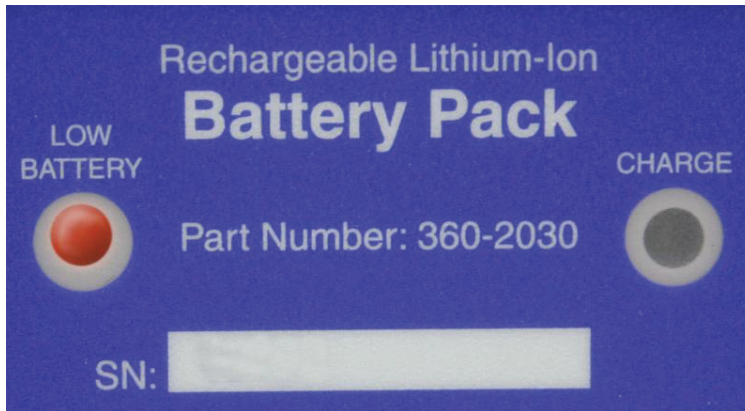

- The pump may continue to be used until the disposable C-cells are depleted.
- Disconnect battery pack from pump prior to recharging the battery pack.

Maintenance

- There is no need to fully discharge the batteries periodically since Li-Ion batteries do not have a memory effect. The battery pack enclosure may be cleaned with a mild soap or disinfectant.

End of Life Determination

The battery in the battery pack degrades with charge cycles and time since manufacture. When the batteries are no longer holding their charge for a sufficient length of time, the battery pack should be replaced.

AC Adaptor/Charger

This accessory becomes the external power source when plugged directly into the **Moog Curlin Infusion** pump. The AC Adaptor can also be used to recharge the portable battery pack by plugging the connecting cable into the recharging port on the battery pack.

There are two AC Adaptors:

- The US Domestic Curlin 6000 AC Adaptors have a three-prong plug to be plugged into a standard three-prong, grounded wall receptacle and a six-foot cable which plugs into the power outlet on the bottom of the pump. The two-pin connector plugs into the receptacle by aligning the red dots on each.
- The International Curlin 6000 AC Adaptors available for international use. The two-pin connector plugs into the receptacle by aligning the key on the connector.

Note: Pause the pump and then turn it off before connecting the AC Adaptor.

Note: The connector is keyed with a “notch” at this red-dot location to guide alignment. To remove, pull back on the locking sleeve to unlock and then pull gently to remove the connector from the battery pack or pump’s port.

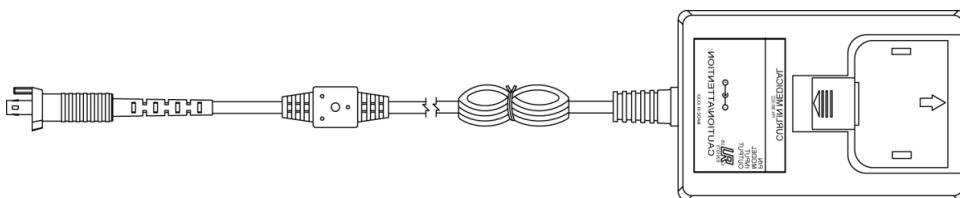

International AC Adaptor

Figure 2.12 Universal AC Adaptor

Two-pin adaptor plugs into port on bottom of the pump for AC power or can be used to recharge the battery pack by plugging into the recharging port on the battery pack. To remove, pull back on the locking sleeve.

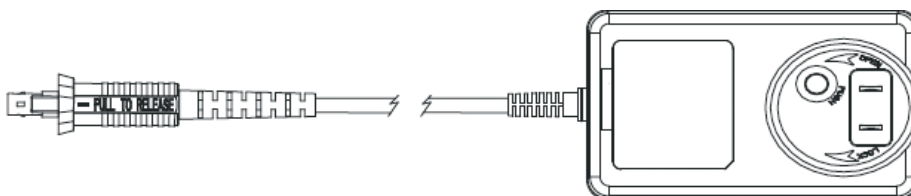

Figure 2.13 International AC Adaptor

Learning Pump Features

*Learning to operate the **Moog Curlin Infusion** pump requires a few basic points of understanding that remain constant in every therapy. It may be helpful to read through these steps first, and then go back and use them to operate the **Moog Curlin Infusion** pump.*

First, examine the key pad and the functions of the individual keys. Knowing how the keys, especially the dual function keys, work will allow you to give commands to the pump.

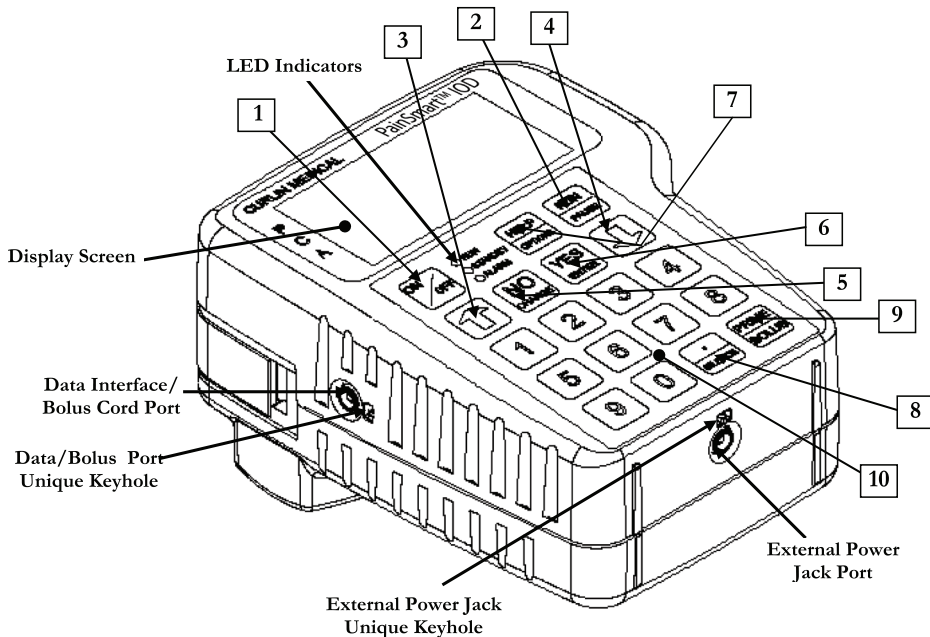

Figure 3.1 Moog Curlin Pump Features

Keypad Function

1. **ON/OFF:** Used to turn the pump on and off. When the pump is running, however, the PAUSE key must be used to stop the infusion first and then the OFF key can be pressed to turn the pump off. This requirement prevents the interruption of an infusion by a single accidental press of the OFF key.
2. **RUN/PAUSE:** Used to start or pause the motor of the pump, which, in turn, starts or pauses fluid delivery. When the pump is running, pressing this key will pause the pump. When the pump is paused, pressing this key during the Run Options menu will start the pump. This key is also used to terminate a pump alarm.
Note: If the cause of the alarm is not resolved when the pump is resumed, the alarm will recur.
3. **↑↑ Up arrow:** Used to scroll the highlight bar or field cursor *up* on the display screen.
Note: The Up arrow will not accept a selection which must be made with a YES/ENTER or NO/CHANGE key.
4. **↓↓ Down arrow:** Used to scroll the highlight bar or field cursor *down* on the display screen.
Note: The Down arrow will not accept a selection which must be made with a YES/ENTER or NO/CHANGE key.
5. **NO/CHANGE:** Used to respond “NO” to data or questions presented or to reject or to change highlighted data.
Note: The **Moog Curlin Infusion** pump requires you to actively change a selection. The Up arrow or Down arrow will not change a selection.
6. **YES/ENTER:** Used to respond YES/ENTER to data or questions presented or to accept highlighted data when prompted to press ENTER key.
Note: The **Moog Curlin** Infusion pump requires you to affirmatively accept a selection. The Up arrow or Down arrow will not accept a selection.
7. **HELP/OPTIONS:** Used to request a help screen when the pump is paused or is at the “Infusion Complete Screen.” It is also used to access the Options Screen when the pump is running. When the Options Screen is displayed, help is again available with this key. When in a help screen, use the arrow keys to scroll through the help message, and then press the HELP key again to exit Help.
8. **./SILENCE:** Used as a decimal point when programming numeric data. Used also to temporarily silence the alarm (for one-minute intervals).
9. **PRIME/BOLUS:** Used to prime fluid through the tubing to clear it of air or to administer a patient demand bolus dose of medication in PCA therapy.
10. **0 - 9 Numeric keys:** - Used for data entry and the display of Info-On-Demand (optional) functions when the pump is in the RUN mode.

Description of the Info-On-Demand (IOD) Feature (Optional) of the Moog Curlin Infusion PainSmart™ IOD Pump



Figure 3.2. PainSmart™ IOD Keypad with Info-On-Demand Feature

To view any of the Info-On-Demand screens on the pump display, press the related key while the pump is in the RUN mode, i.e., running a therapy. The information requested will be displayed for 8 seconds and then the display will return to the previous infusion screen.

One exception is the HrlyTot /5 key.

The information for the HrlyTot /5 key will be displayed for 15 seconds and then the display will return to the previous infusion screen.

Another exception is the CLRShft /9 key.

The information for the CLRShft/9 key will be displayed for 11 seconds and it will allow the user to CLEAR or EXIT within the 11 seconds or the screen will revert to the RUN screen automatically.

Info-On-Demand (IOD) Key Functions

Designation and functionality of the ten numeric keys of the Info-On-Demand keyboard:

1. **Date and Time (DateTime):** The Date and Time screen displays the current date and time according to the pump. Changes to this screen are not allowed.

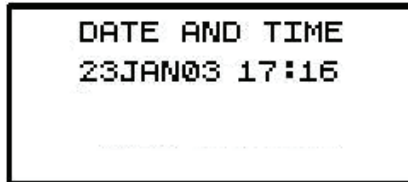

2. **Power Check (PowrChck):** The Power Check screen displays the active power source of the pump, whether internal (batteries) or external. If the active source is the C-cell batteries, a bar graph will indicate the amount of power remaining in the batteries. This graph is only an approximation of the charge left in the batteries and not intended to give specific representation of the battery life. Furthermore, the bar graph should NOT be used to check the state of the external NiMH battery pack, because it will not provide with accurate results.

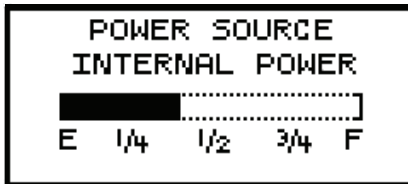

3. **Option Info (OptnInfo):** This screen provides information on selected options. The information displayed here includes the status of the Lock Level, Down Occlusion, Air Sensors, and the Audio Level. Changes to this screen are not allowed.

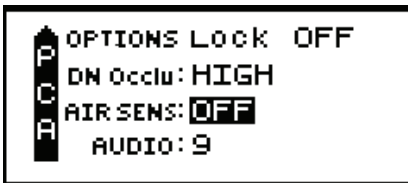

4. **Hold Screen (HoldScrn):** Pressing the Hold Scrn/4 key will hold the current Run screen information for an additional 8 seconds and then the pump will return to the normal running screen. Changes to this screen are not allowed.

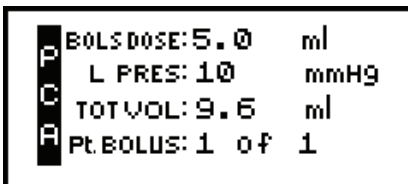

5. **Hourly Total (HrlyTot):** The information displayed here includes the hourly Volume (amount) Infused, the number of Bolus Given and the number of Bolus Asked. Within the allocated 15 seconds, the user can scroll up or down the screen. Changes to this screen are not allowed.



HR	VOL-ml	BG	BA
19	9.0	0	0
20	10.9	1	2
214	4.8	0	0

6. **Therapy Information (ThrpyInfo):** The information displayed in this screen is from the pre-prescription menu and includes Units, Concentration, Administration Route and Load Dose. Changes to this screen are not allowed.



UNITS:	mg	
CONCEN:	0.0	mg/ml
ADMINRT:	IU	
LOAD DOSE:	0.0	mg

7. **Rx Information (RxInfo):** This screen provides prescription menu information such as Basal Rate, Patient Bolus, Bolus Interval, and Number of Bolus per Hour. Changes to this screen are not allowed.



BASLRATE:	8.0	ml/hr
Pt. BOLUS:	5.0	ml
BOLS INT:	6	MIN
#BOLS/hr:	10	

8. **Percent Bolus (%Bols):** This screen provides Bolus Volume as percentage of Total Volume. TBOL is the total volume infused through bolus, TVOL is the total volume infused, and % BOLS is the percentage of TBOL over TVOL. Changes to this screen are not allowed.

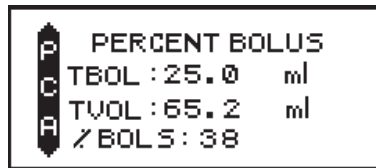

9. **Clear Shift Total (CLRShft):** Two Shift Total screens are displayed for 11 seconds when this key is pressed. This key allows the user to view or CLEAR the Shift Totals (this action does not interfere with the operation of the pump).

To **CLEAR** the Shift Totals information to zero, press the CLRShft/9 key, and then press the YES/ENTER button in response to the “DONE? CLEAR” question and the pump will go back to the running screen. Press the CLRShft/9 key again to verify that the values are reset or cleared.

To **EXIT** the Shift Totals screens without clearing, press NO/CHANGE for the “DONE? CLEAR” question and then YES/ENTER for “DONE? EXIT” and return to the running screen. The pump will return to the running screen automatically after 11 seconds have elapsed since the pressing of the CLRShft/9 key, even if no key is pressed.

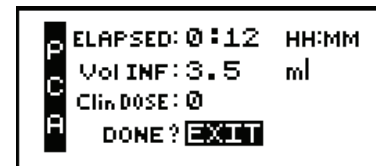
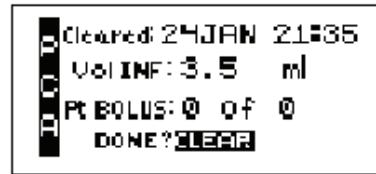

10. **Check Maximum Infusion (ChckMax):** The information displayed here is the maximum (rate or amount) that can be infused hypothetically, given the prescription parameters. This “Maximum Infusion per Hour” serves as a “sanity check” after the pump has begun infusing. Changes to this screen are not allowed.

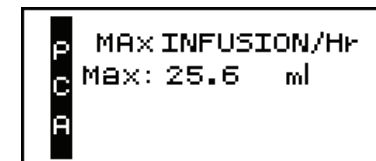

Description of the Custom Features

A customized **Moog Curlin Infusion** PainSmart™ IOD pump may have Maximum Basal Rate Limit, Maximum Pt. Bolus Dose, Clinician Dose, and Load Dose Limits values that are different from default maximum values for all administrative routes (IV, EPI, and SQ), and a different Lock Level other than the default value OFF. These values, once programmed at the factory, can not be changed unless the pump is initialized or a new setting is programmed, both of which must be performed by **Moog Curlin** or factory trained BioMedical professionals.

Customized Maximum Basal Rate Limit

A customized **Moog Curlin Infusion** PainSmart™ IOD pump may come with a Maximum Basal Rate Limit value set in the factory that is different from the default maximum value.

An alert will be displayed if a value greater than the factory set Maximum Basal Rate Limit value is entered in BASL RATE, MedLMTS Mx Rate, and MedLMTS Delta Rate.

For example, while programming a PCA (IV) therapy in a customized **Moog Curlin Infusion** PainSmart™ IOD pump, where the Maximum Basal Rate Limit is factory set to be 9.9 for IV administration route, if you enter 21 for BASL RATE, an alert message will appear:

“GREATER THAN MAX. FIELD LIMIT MAX=9.9”

The values you are allowed to enter in this example, for BASL RATE, are between 0.1 and 9.9, with an increment of 0.1. Same limit will apply to MedLMTS Mx Rate, and MedLMTS Delta Rate also, if the therapy calls for them.

Customized Maximum Bolus, Clinician, and Load Dose Limits

A customized **Moog Curlin Infusion** PainSmart™ IOD pump may come with Maximum Pt. Bolus, Clinician, and Load Dose Limit values set in the factory.

An alert will be displayed if a value greater than the factory set value is entered in Load Dose, Clinician Dose, Pt. Bolus, and MedLMTS Pt. Bolus.

For example, while programming a PCA (IV) therapy in a customized **Moog Curlin Medical** PainSmart™ IOD pump, where the Maximum Pt. Bolus Dose Limit is factory set to be 9.9 for IV administration route, if you enter 10 for LOAD DOSE, an alert message will appear:

“GREATER THAN MAX. FIELD LIMIT MAX=9.9”

The values you are allowed to enter in this example, for LOAD DOSE, are between 0.1 and 9.9, with an increment of 0.1. Custom limits also apply to Clinician Dose, Pt. Bolus, and MedLMTS Pt. Bolus also, if the therapy calls for them.

Customized Lock Level setting

A customized **Moog Curlin Infusion PainSmart™** IOD pump may have a certain Lock Level value set in the factory which is not the default OFF. It can be any one of these values: Lock Level 1, Lock Level 2, or Lock Level 3.

The pump user is not allowed to change the customized factory programmed Lock Level setting. If you attempt to change the customized Lock Level, the pump will display an alert, “MODIFICATIONS NOT ALLOWED.”

LED Light Indicators

This three-light feature gives the user feed back on the current status of the pump.

1. **Green** indicates a Running status of the pump and blinks approximately once every three seconds when a therapy is in progress.
2. **Yellow** indicates a Standby status of the pump and blinks while the pump is paused.
3. **Red** indicates a Stopped or Alarm status of the pump and blinks whenever an alarm status exists.
4. **Green and Red** indicates an Infusion Complete Alarm status with KVO or a Down Occlusion Alarm with automatic restart.
5. **Yellow and Green** indicates a Standby status with automatic start. This occurs when a “0” basal rate and bolus only is programmed.

Audio Indicator

An audible alarm or “beep” is used to alert you to a change in the status of the pump or a situation requiring user action or notification. A message will appear on the display screen describing the situation. The rate, number of beeps, and volume further specify status. This pump offers nine different volume levels from which to select for the audio feature; however, the beep cannot be totally disabled. The audio beep can be silenced for one-minute intervals by pressing the SILENCE key except during an Error Code, at which time the alarm continues and the pump must be turned off. The chapter of this manual, entitled “Troubleshooting,” includes tables with the alerts, alarms, error codes, the conditions causing them, the message displayed on the screen, and the actions required for resolution. If an alert or alarm occurs, please refer to these tables.

Display Screen

The display screen provides a maximum of four lines of text, or fields, at any one time for feedback regarding the pump status and data entry. It notifies the user with prompts or messages when necessary. The screen has backlighting that remains:

- on if connected to an AC outlet
- lit for 30 seconds if using batteries or 120 seconds during any programming key press sequences
- on with alert/alarm messages

When no keys are pressed the light goes off to conserve battery power. Backlighting is resumed with any key press.

In most displays, a Therapy Identifier bar appears at the far left of the screen, indicating which therapy is running or which programming screen is being considered. This identifier also has another function, and that is to alert you when more text exists either above the top line or below the bottom line on the display screen. The identifier bar will have an arrow configuration either pointing up or down or both whenever there is more text, or it will appear as a squared-off block if no further text exists.

The screen also has a cursor or highlight Bar to tell you which field is being considered. Use the up and down arrow keys to move the cursor. When the pump is running, a specially designed Running Screen appears to provide information regarding the status of that particular infusion. In the following chapters, each display screen will be explained.

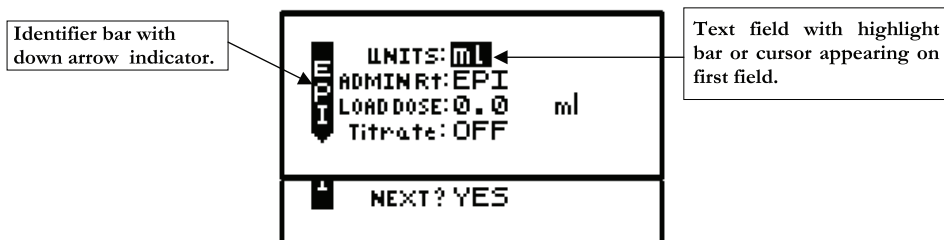

Figure 3.3 Sample of Display Screen

Basics of Programming

The *Moog Curlin Infusion* pump allows the operator to customize this device to meet the specific infusion needs of each individual patient. This chapter will explain the customizing features along with the programming steps.

Programming the **Moog Curlin Infusion** pump requires initial orientation and training, but the programming steps have been designed to be user friendly and self-prompting to minimize training time.

Several different types of screens and fields may appear on the displays. Each of the different types of screens is explained below. Whenever you are required to interact with the pump, a highlight bar or cursor will be present on the screen.

Types of Display Screens

1. An Action Field Screen allows you to select a pump action from the menu.

Sample of an Action Field Screen



To select a field other than the one highlighted, use the arrow keys to move the cursor up or down to the desired field. When the cursor is highlighting the correct field and you press the YES/ENTER key, the pump accepts the selection and executes that action. In the example above, the pump would proceed with steps to resume the therapy.

2. A Selection List field allows you to select from a predetermined list of values:

Sample of a Selection List Field



The above example allows you to select which unit to use in programming—e.g., Units: mL, mg or mcg. Only one selection is displayed at a time. When the cursor blinks it is indicating that no selection has yet been accepted. The selection displayed on the screen changes each time you press the NO/CHANGE key. Pressing the YES/ENTER key accepts the selection displayed and moves the cursor to the next field.

When programming the pump outside of the LIBRARY mode, the word “Unidentified” will be displayed on the top line of several of the screens. This indicates that the pump has been manually programmed. “Unidentified” is a place holder where the drug name would be displayed if the program had been chosen from the library.

3. Data Entry Screens are used to specify prescription parameters.

Sample of a Data Entry Screen

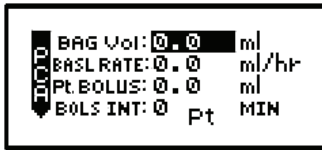

In the above example, the cursor rests on a field requiring numeric data entry for specific prescription information, e.g., the volume in the IV bag. The operator enters the correct information using the numeric keys and decimal point key. When the correct data is displayed and the YES/ENTER key is pressed, the pump accepts the selection if it is a valid entry value and moves the cursor down to the next field. If the down arrow key is used to move to the next field, the value reverts back to default or the last programmed value.

4. Running Screens display information to the operator about the progress of the specific infusion while the pump is running:

Sample of a Running Screen

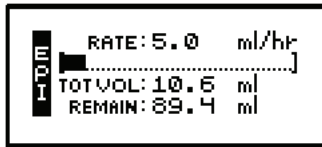

The standard running screen displays the Mode Identifier, the rate of pumping, a graphical bar that indicates the progress of the infusion, the volume already infused, and the time remaining for the infusion. No action is required on a run screen, therefore, no highlight bar appears. In some therapies a field may toggle to give the operator more information, i.e. the REMAIN field may change from *HH:MM* (time remaining) to *mL* to tell you how much volume is remaining as well. The information on the run screen will alternate between a four-line display and a large font display of each line of information on the screen.

5. User Notification Screens are messages displayed to the user for information.

Sample of User Notification Screen

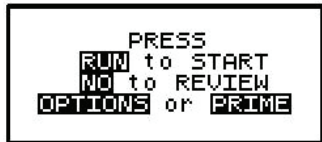

Words representing keys are displayed in reverse video (shown in this manual as bold text and/or capitalized). The action requested by a notification screen is either to press a specified key or to resolve an alert, alarm, or error code.

For all events such as alerts, alarms, or error codes, specific notification screens will also be displayed. (See chapter entitled “Troubleshooting” for specific alert, alarm, and error code messages and how to resolve them.) The audio alarm also beeps and the LEDs blink whenever an alarm or error code occurs. In the event of an error code, user directions will be

displayed on the screen, most often; this will require turning the pump off and back on again.

Using “Help”

Help screens are available for data entry/selection screens, during Action Field screens (refer to sample screen on pg. 45), and at the Infusion Complete screen. To access help, press the HELP key. Use the arrow keys to scroll through the help message, and then press the HELP key again to exit help. When a help screen is displayed and there is more text to read which is not currently on the screen, a small up (▲) or down (▼) arrow indicator will appear to let you know you can scroll up or down to read the complete help message.

Starting the Pump

Start the pump by pushing the orange ON key. The following screen displays:



The above Welcome Screen gives the date, time, and a message that the pump is performing a self-diagnostic test. The display also lists the software revision number for this pump and if library is enabled, the library name will appear at the bottom of the screen.

During this test, you will hear three beeps as each of the LED indicators blink. If any one of the green, yellow, or red LED lights fails to light or to blink, return the pump for service. If the self-test fails, the alarm will sound, and a new screen will appear stating: “ERROR CODE:#” or “SYSTEM ERR:#” (See “Troubleshooting” chapter for a list of error notices and how to resolve them). The error notice will include a numeric code. At any error notice, the only user option is to turn the pump off.

IMPORTANT INFORMATION

If, at any time, there is indication of pump damage, error code, or messages requiring the pump to be turned off, call the healthcare agency or facility as directed to report the condition.

Note: If an error notice appears, turn the pump off and back on again. If the pump passes its start-up diagnostics tests, you can safely resume the therapy. If the error notice recurs, however, turn the pump off and notify the healthcare agency responsible for monitoring the pump. Some error notices may reset the pump back to its default settings and therefore will require reprogramming.

When the **Moog Curlin Infusion** pump successfully passes its self-test, a brief message of “SYSTEM OK” appears, and the display moves to the next screen:

Power Status Screen

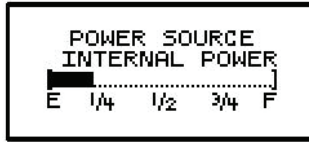

This screen displays the active power source of the pump, whether internal (batteries) or external power. If the active source is the C-cell batteries, a bar graph will indicate the amount of power remaining in the batteries. This graph is only an *approximation* of the charge left and is not intended to give a specific representation of battery life. The display will again automatically move to the next screen:

Preventive Maintenance Screen



The above alert screen will appear after the Welcome Screen *only* when the maintenance due date has arrived and will continue to appear until the date has been reset during the actual maintenance performance. The pump may continue to be used after the maintenance due date but should be returned for its routine maintenance at the earliest opportunity.

Select Program or BioMed Setup Screen

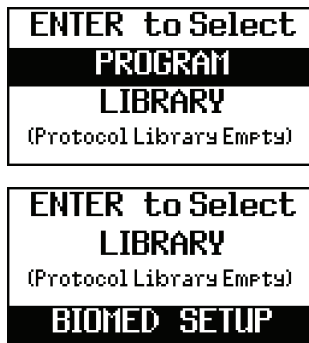

This screen is the first requiring you to act. It gives two selections from which to choose, “PROGRAM,” “LIBRARY” or scroll down two screens from Library to “BIOMED SETUP.” Using the up or down arrows, move the cursor to the desired field and then press the ENTER key. Selecting “PROGRAM” allows you to proceed with choosing features and entering data required for the pump to deliver a prescribed therapy.

Selecting “LIBRARY” allows you to enter customized library and choose pre-programmed prescription to deliver therapy. Library is an optional feature on some pumps.

Selecting “BIOMED SETUP” allows the pump to be programmed and customized by the clinician to perform a number of special functions including setting the system clock. (See BIOMED SETUP) Accessing “BIOMED SETUP” requires you to enter a clinician access code. (Refer to the chapter entitled, “Clinician Information and Access Code,” of this manual.)

Access Code

Clinician Access Code Screen

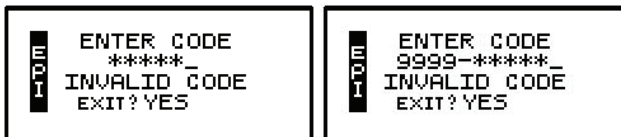

Depending on the configuration of your pump, the clinician enters a five-digit access code; or a four-digit personal identification number followed by the five-digit access code; and, if the code is valid, the display will automatically move to the requested screen or field. The four-digit personal identification number appears on the screen but the access code numbers do not; instead five asterisks appear. **If the “four-five” configuration is selected, the personal identification number is recorded in the history file for the purpose of providing an audit trail.** If an invalid code is accidentally entered, a message displays “INVALID CODE” and the clinician can reenter the correct code.

Note: After entering the access code, DO NOT press the YES/ENTER key. The pump will automatically recognize the correct code and give you access to the secured section.

IMPORTANT INFORMATION

If an access code screen displays and the access code is not known, use the down arrow to move the cursor to the “EXIT?” field. Press the YES/ENTER key at this field to return to the previous screen and make another selection. Also, remember that the HELP key is available when the pump is paused.

Look first at the BioMed SETUP menu and its special customization features:

BioMed Setup

BioMed Setup Menu

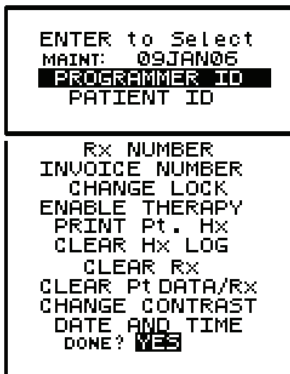

The BioMed Setup menu lists special optional customization and performance functions of the pump:

**IMPORTANT
INFORMATION**

You may skip any of these functions by using the down arrow to move the cursor to only the desired selection. When the desired selection is highlighted, press the YES/ENTER key. A secondary screen will be displayed. When all BioMed Setup functions are completed, move the cursor to the last field, “DONE? YES,” and press the YES/ENTER key to exit this menu.

1. PREVENTIVE MAINTENANCE DATE: The first field displays the date the pump requires its annual routine preventive maintenance check.

Note: You cannot change this date; it is changed only when a factory technician performs the routine pump maintenance.

The clinician that initially programs the pump for a patient should note the maintenance date. Once this date arrives, a “Perform Routine Maintenance” message will briefly appear after the Welcome Screen. If the maintenance due date will occur during the time the patient will be on service, the clinician **may** wish to select another **Moog Curlin Infusion** pump for this patient. This action will avoid any undue concern on the patient’s part at the notice of “Maintenance Due” and eliminate the need to recall a pump in service for maintenance. The pump, however, can continue to be used without disrupting service when this message appears, but should be returned for service as quickly as possible.

2. PROGRAMMER ID: This feature gives the programmer the option to use the numeric keypad to enter his or her assigned ID number (up to ten digits). If this option is not to be used, it can be left blank and skipped, using the down arrow to scroll to the next field. When the PROGRAMMER ID number is satisfactory, press the YES/ENTER key at the “ACCEPT? YES/NO” field and the number will be stored in the pump history log.

3. PATIENT ID: This feature gives the programmer the option to use the numeric keypad to enter a patient ID number (up to ten digits). If this option is not to be used, it can be left blank and skipped, using the down arrow to scroll to the next field. When the PATIENT ID number is satisfactory, press the YES/ENTER key at the “ACCEPT? YES/NO” field and the number will be stored in the pump history log.

4. Rx NUMBER: This feature gives the programmer the option to use the numeric keypad to enter a prescription number (up to ten digits). If this option is not to be used, it can be left blank and skipped, using the down arrow to scroll to the next field. When the Rx NUMBER is satisfactory, press the YES/ENTER key at the “ACCEPT? YES/NO” field and the number will be stored in the pump history log.

5. INVOICE NUMBER: This feature gives the programmer the option to use the numeric keypad to enter an invoice number (up to ten digits). If this option is not to be used, it can be left blank and skipped, using the down arrow to scroll to the next field. When the INVOICE NUMBER is satisfactory, press the YES/ENTER key at the “ACCEPT? YES/NO” field and the number will be stored in the pump history log.

6. CHANGE LOCK: This selection allows the clinician to change the lock setting of the pump. This feature is also available under the OPTIONS menu of each therapy. There are four choices in this field: "OFF," "1," "2," or "3." When the lock is set to OFF, the clinician has access to all pump functions. Each level higher limits the options available to the patient or caregiver (see each lock option screen in the individual therapy sections and/or the lock level table in the chapter entitled "Clinician Information and Access Code"). If the desired lock does not appear on the display, press the NO/CHANGE key until the correct lock does appear. Then, press the YES/ENTER key to accept and move the cursor to the next field.
7. MANUAL PROGRAM: This field is used to customize the **Moog Curlin Infusion** pump to ENABLE/DISABLE the PROGRAM menu option on the main menu. There are two choices: "OFF" and "ON." When MANUAL PROGRAM is set to "OFF" the PROGRAM menu option is not available on the main menu.
 - a. To enable MANUAL PROGRAM, press the NO/CHANGE key until the selection states ON.
 - b. To disable MANUAL PROGRAM, press the NO/CHANGE key until the selection states OFF.
 - c. When the ON/OFF status is satisfactory, move the cursor to the last field, "ACCEPT?" and press the YES/ENTER key to accept. To abort the enable therapy process, press the NO key to exit this menu and return to the BioMed Setup Menu.
8. ENABLE THERAPY: This field is used to customize the **Moog Curlin Infusion** pump to the specific therapy ordered for the patient. When you select this function by pressing the YES/ENTER key, the menu below appears, listing all five of the possible therapies. The pump's default setting is to enable PCA and disable all other therapies.

Enable Therapy Menu

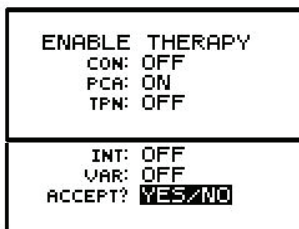

You will not be allowed to change the default setting. If you attempt to enable a therapy, the following prompt will appear of this fact.



Patient History Log

The patient history log is a cumulative record of the approximately last 6,000 events that have occurred in the pump. Example: When prescription information is saved using the YES/ENTER key at the “DONE” or “ACCEPT” fields, a copy of the information also gets date and time stamped and is recorded in the patient history log. Alarms, error codes, certain alerts, and certain key press events also get logged when they occur. The patient history log can be printed using the **Moog Curlin Infusion** print package and by selecting the “Print Pt. Hx” option. Selecting the “Clear Hx Log” option will erase the patient history log. When the history log is full, it will overwrite on a first-in, first-out basis.

Note: The patient history log should be printed before clearing occurs if a hard copy record is required. The history log, when printed, lists the most recent event first. Clearing the history log does not affect the saved patient information.

When printed, the patient history log includes a heading at its beginning and a footer at its end. The heading includes the pump serial number, the patient history log title and revision number information of the software and hardware of the pump. The footer contains information about how much of the history log has been used. The information is printed with the most recent event first, and organized for easy transfer to a spreadsheet for sorting and reporting. A partial sample of a history log is given on the following page:

History Event Log

```
SERIAL NUMBER           :201293
MANUFACTURE DATE        :10AUG00
MAINTENANCE DUE DATE    :16JAN04

HISTORY EVENT LOG
22JAN03 15:38 ml/Vin/mmH/BV:9070.6/2.2/8/0.76
22JAN03 15:18 ml/Vin/mmH/BV:8937.3/2.2/10/0.76
22JAN03 14:58 ml/Vin/mmH/BV:8803.9/2.2/10/0.76
-----
21JAN03 16:58 ml/Vin/mmH/BV:2.1/3.1/0/0.78
21JAN03 16:57 ml/Vex/mmH/BV:0.0/6.7/0/0.78
21JAN03 16:57 START PUMP :0.0 ml
21JAN03 16:57 START THERAPY
21JAN03 16:57 AIR FILTER ? :YES
21JAN03 16:57 RUN/PAUSE KEY
21JAN03 16:57 CON RUN OPTION
Options           :Lock OFF
Lock              :OFF
Hourly Tot       :OFF
Clear Hrly       :OFF
Dn Occlu         :HIGH
Air Sens         :OFF
Audio            :9
PWR CK           :OFF
Accept OPT       :YES/NO
21JAN03 16:57 CON Rx
Bag Vol          :9900 ml
Amt TBI          :9500 ml
Rate             :400.0 ml/hr
Time             :23:45 HH:MM
KVO Rate         :0.1 ml/hr
Done?            :YES
21JAN03 16:57 CON PRE Rx
Units            :ml
Delay            :OFF
Titrate          :OFF
Next?            :YES
21JAN03 16:57 REPEAT Rx
21JAN03 16:56 ON PUMP
21JAN03 16:33 OFF PUMP
Patient Hx Log Used (bytes): 1693 of 61440
```

Figure 4.1 History Event Log

9. PRINT PATIENT HISTORY: To print the patient history log, connect the Data Interface Cable to the communication port on left side of the pump before selecting this command. (FOLLOW DIRECTIONS THAT ACCOMPANY THE DATA INTERFACE CABLE.)

The pump will display:

```
PRINT Pt. Hx
ACCEPT? YES/NO
```

When you select “YES,” the display will read “Printing Patient History Record.” When the printing is completed, the pump display returns to the BioMed Setup Menu. To abort the printing process, press the NO/CHANGE key on the pump’s keypad, and the display will return to the BioMed Setup Menu. If the Patient History Log stops before all data is transferred, exit and restart the “Print Pt. Hx” command.

Note: To utilize the print feature of the **Moog Curlin Infusion** pump, you must have a PC running the hyperterminal program within MS Windows™, and use the **Moog Curlin Infusion** Data Interface Cable which is purchased separately. Detailed user instructions are provided with the cable.

Clearing the History Log

10. CLEAR Hx LOG: This feature is used to clear the patient history log from the pump. When you select YES/ENTER, the pump displays:

```
CLEAR Hx LOG
YES CLEARS Pt.
Hx Log/ Not Data
ACCEPT? YES/NO
```

When you select “YES”, the history log is cleared and the display returns to the BioMed Setup Menu. Selecting “NO” aborts the feature and also returns to the menu.

Clearing Patient Information

11. CLEAR Rx: When this command is selected, prescription information for all currently programmed therapies is cleared; however, the patient data is retained. When you select YES/ENTER the pump displays:

```
CLEAR Rx
YES CLEARS ALL
Rx Data
ACCEPT? YES/NO
```

When you select “YES”, all prescription programs are cleared, and the display returns to the BioMed Setup Menu. Selecting “NO” aborts the feature and also returns to the menu.

12. CLEAR Pt. DATA/RX: **Selecting this feature clears all data programmed. The history log is NOT cleared.** When you select YES/ENTER at this field, the following screen displays:

```
CLEAR Pt DATA/Rx
YES CLEARS ALL
Pt Data & Rx's
ACCEPT? YES/NO
```

When you select “YES,” all patient data clears and the display returns to the BioMed Setup Menu. Selecting “NO” aborts the feature and also returns to the menu.

13. CHANGE CONTRAST: The contrast on the display screen is automatically optimized and is no longer changeable with this option.

Changing Date and Time

14. CHANGE DATE AND TIME: When this field is selected, the screen on the left appears:

Change Date and Time Screen

DATE AND TIME CLOCK: 24hr TIME: 17:16 HH:MM DATE: 23JAN05	DATE AND TIME CLOCK: 12hr AM/PM: AM TIME: 17:16 HH:MM
ACCEPT? YES/NO	DATE: 23JAN05 ACCEPT? YES/NO

This screen is used to set the system Real Time Clock in the pump and will change the date and time displayed on the Welcome Screen.

- Note:** The time must be reset to accommodate daylight savings time changes and also at any time the pump is moved into a different time zone.
- Time Format:** You have the option of selecting a twelve-hour or twenty-four-hour time format. Press the NO key until the correct selection appears on the field and then press the YES/ENTER key to accept the selection and move the cursor to the next field.
 - AM/PM:** The second field allows you to select AM or PM when the twelve-hour time format is selected in the previous field. If the twenty-four-hour format was selected, this field will not appear. Press the NO key until the correct selection appears on the field, and then press the YES/ENTER key to choose the selection and move the cursor to the next field.
 - Time:** Use the numeric keys to enter the correct time and then press the YES/ENTER key to accept and move the cursor to the next field.
 - Using the numeric keys, enter the correct mm/dd/yy, using two digits for each (e.g., if the month is January, enter 01; if it is a single digit date, use the number preceded by a 0 and then enter the last two digits of the year code, 00, 01, etc.). When the date is correct, press the YES/ENTER key to accept and move to the next field.
 - A final prompt will be given to “ACCEPT? YES/NO.” If any data needs to be corrected, use the arrow keys to locate the correct field, press NO to change the data, enter the correction(s), and then press YES/ENTER again to accept the correction. Move the cursor back to the “ACCEPT? YES” field and press YES/ENTER. This action enters the new time and date and moves to the next field in the BioMed Setup Menu. Pressing the NO key on this field aborts the change date and time selection and returns to the BioMed Setup Menu.

**IMPORTANT
INFORMATION**

If a therapy is in progress, the date and time changing functions will not be accessible until the therapy is complete. If “***ALERT*** DATE AND TIME CHANGE NOT ALLOWED” appears you will need to go to CLEAR PATIENT DATA/Rx above date and time and choose “enter” and the “YES” to clear “Pt data and Rx.” Then date and time change will be allowed.

15. When BIOMED SETUP is complete, move the cursor to the “DONE?” field and press the YES/ENTER key to return to the Program or Set-Up Menu Screen.



To select “PROGRAM” use the arrow keys to move the cursor to the PROGRAM field and press the YES/ENTER key. If no therapy is already programmed, a “Select Therapy Screen” appears prompting you to select a therapy. If a therapy has been programmed, the following screen appears:



There are three different ways that you can start a therapy:

- RESUME: Should be used if a therapy is interrupted. The pump picks up where it left off, and continues the therapy.
- REPEAT Rx: Should be used to hang a new bag and repeat the same therapy over again. The infusion history displayed is reset (volume infused, boluses requested, boluses received, etc). Shift Totals and Hourly Totals continue to accrue.
- NEW PROGRAM: Should be used to program a totally new Rx. All the therapy parameters in the pump are set to factory default and must be re-entered by the clinician.

The judicious choice of the option can help speed up programming. This screen gives you all three options:

Resuming a Therapy

1. RESUME—If a therapy is interrupted and the pump is turned off or paused before completion of the infusion, you may select “RESUME” by moving the cursor to this field and pressing the YES/ENTER key. A notification screen displays, and a prompt is given to run the pump. At this time, you can continue to infuse the prescription from the exact point at which it was interrupted.

Note: Patients should be taught proper time frames or limitations for leaving their IV bags or medication reservoirs hanging during an interrupted state and, if indicated, to change to a new bag according to the healthcare provider’s policies and drug manufacturer’s instructions.

Repeating a Pre-Programmed Therapy

2. REPEAT Rx—Use this feature if an infusion is complete and you wish to repeat the same prescription over again or if a therapy is programmed and the pump is turned off before the infusion is started. Select this field by moving the cursor to REPEAT Rx, and press the YES/ENTER key.

If the pump has been programmed for more than one therapy and you wish to select a therapy at this time, move the cursor to “REPEAT Rx,” and press the YES/ENTER key. This action will take you to the Select Therapy Screen and allow you to choose which of the programs you now wish to repeat.

Note: If you are choosing a therapy that is different than the last one selected, Shift Totals and Hourly Totals will be cleared.

If only one therapy is programmed and “REPEAT Rx” is selected, the cursor will automatically advance through the prescription menus. You can stop the auto-advance function by pressing any key (except ON/OFF) and then complete the confirmation of the prescription by pressing the YES key at the remaining fields.

Note: REPEAT Rx does not allow any changes to the Pre-Prescription Menu. If changes need to be made in Pre-Prescription selections (units, concentration, etc.) select “New Program” and reenter the entire prescription.

The lock settings affect the use of “REPEAT Rx.” Lock 1 allows REPEAT with changes to the prescription screen only. Lock 2 allows REPEAT but does NOT allow the user to make changes in the prescription. Lock 3 does not allow REPEAT. (See lock setting table.)

If a therapy has not completed and the “REPEAT Rx” function is selected, the following screen will display:

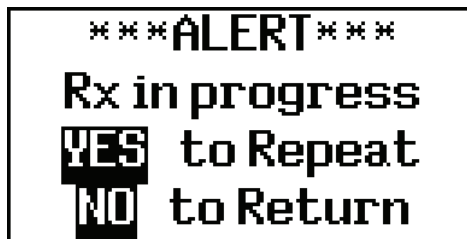

If the current infusion is to continue, press “NO,” and you will be prompted to resume the therapy.

If the current infusion is to be discontinued and a new IV bag started, press YES/ENTER to repeat. The following screen will then appear, asking whether or not you wish to maintain the current Bolus or MedLMTS™ schedule.

```
Maintain Current
Bolus/medLMTS
Schedule?
YES or NO
```

Pressing “YES” will maintain the current schedules and continue with the programming of the pump. Answering “NO” will display the following screen, asking you to confirm the clearing of the schedules.

```
Clear
Bolus/medLMTS
Schedule?
YES or NO
```

Pressing “YES” will clear the current schedules and continue with the programming of the pump. Answering “NO” will return you to the prior screen.

How to Go to “New Program”

NEW PROGRAM—If the cursor is moved to this field and the YES/ENTER key is pressed, the display will automatically move to the first screen for a new programming.

```
ENTER to Select
RESUME
REPEAT RX
NEW PROGRAM
```

Entering or Changing Data Fields

When prescription data fields appear, use the numeric keys to enter specific patient prescription information and, when correct, press the YES/ENTER key to accept. If a field on the menu is not accepted by the program, a context-sensitive alert prompt will appear and the cursor returns you back to the fields that require the change, to help you resolve the problem.

The following screen is the general alert prompt:

```
***ALERT***
INVALID ENTRY
```

Programming a PainSmart pump with Protocol Library Safety System (PLSS) Version 2 program

Refer to Protocol Library Safety Software manual, part number 360-7042

YES key is used to verify or enter

NO key is used to change, erase or leave screen

Turn the pump on, watch self test and power source bar.

Set tubing must be installed for pump to run.

Press the \uparrow and \downarrow keys to scroll through the menu, and press the **YES** key to accept/confirm a field entry and the **NO** key to reject/change a field entry.

Note: Library therapies may have soft or hard limits set for various values.

```
ENTER to Select
PROGRAM
LIBRARY
ABC V.1
```

For PCA therapies: Hard or soft limit settings may be set for Max Basal Rate, Max Patient Bolus Amt, and Min Bolus Interval. Hard limits may be set for Max Load Dose.

Note: A warning screen will display if a value is entered that is out of range of the soft limit setting(s) for a downloaded therapy. The screen will ask the user to override the soft limit value.

Pressing **YES** will accept the new value, example below:

```
***ALERT***
VALUE ↑ LIMIT
5      ↑ 0.4
OVERRIDE? YES/NO
```



Programming a Pump with a Protocol Library

Note: The ability to program, resume, or repeat a Library Protocol is restricted to the LIBRARY menu option.

Press ↓ to scroll down to the “LIBRARY” function.

Highlight “LIBRARY,” and then press “YES”, the following screen appears:

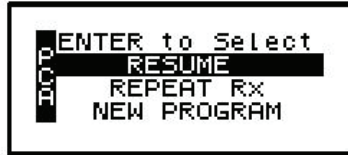
Resume/Repeat Rx/New Program Menu



Note: The “RESUME” and “REPEAT Rx” options may not appear if a therapy has not been previously programmed or has run to completion.

There are three different ways that you can start a therapy:

- RESUME: Should be used if a therapy is interrupted. The pump picks up where it left off, and continues the current therapy.
- REPEAT Rx: Should be used to hang a new bag and repeat the same therapy over again. The infusion history displayed is reset (volume infused, boluses requested, boluses received, etc). Shift Totals and Hourly Totals continue to accrue.
- NEW PROGRAM: Should be used to program a totally new Library Rx.

Programming a New Library Therapy

NEW PROGRAM—If the cursor is moved to this field and the YES/ENTER key is pressed, the display changes to allow you to select which Library Therapy you wish to program:

1. If the desired Category/Care Area is not already listed on the first screen, select “YES” to answer “Page Down.” This will bring up additional screen(s) with additional choices.
2. If Category/Care Area is already listed on first screen press ↓ to scroll down to choice you wish to select.
3. When the Category/Care Area that you wish to choose is highlighted, press “YES” to select that option.
4. If the Library Therapy is not already listed on the first screen select “YES” to the right of “Page Down.” This will bring up additional screen(s) with additional choices.
5. If the Library Therapy is already listed on first screen press ↓ to scroll down to choice you wish to select.
6. When the Library Therapy that you wish to choose is highlighted, press “YES” to select that option.
7. Press “YES” again to “ACCEPT” this Library Therapy selection.
8. An optional “ADVISORY” <message> may appear. Press “YES” to continue or “NO” to return to main Library Screen.

9. To use the Library Therapy as pre-programmed in the pump, select “**YES**” in each highlighted area to accept the information. To change any of the preselected drug therapy options when highlighted, press “**NO**” and enter correct information.

Note: Some options may be hard locked so that changes cannot be made or there may be preset limits that cannot be exceeded for safety.

Note: “**YES**” must be selected after each field when flashing to be accepted, if “**YES**” is not pressed after each field the pump will say: “***ALERT*** FIELD NOT ACCEPTED” and will not allow you to continue programming.

Continue through each field until the RUN to START Screen appears after selecting done.

11. In the RUN to START Screen, you have four options:

RUN to START	to begin the infusion
NO to REVIEW	to check orders and make changes
OPTIONS	to access additional features such as air sensor, down occlusion setting, audio
PRIME	to prime the set tubing via the pump

12. In the RUN to START Screen choose “**NO**” to review, to validate therapy with another clinician. Press “**YES**” at each highlighted field to confirm choices, “**NO**” to change. (Note this should be done prior to priming the set tubing on the pump)

13. When you reach the RUN to START Screen for the second time you can now prime the set tubing.

To prime the set tubing via the pump press the PRIME button at the bottom of the pump, follow on screen instructions and hold the prime key down. Keep the button depressed until you are finished priming. Release the prime button to stop and press “**YES to EXIT**” to return to the RUN Screen.

14. You can now begin your infusion by pressing “**RUN to START.**”

Resuming a Library Therapy

RESUME—If a therapy is interrupted and the pump is turned off or paused before completion of the infusion, you may select “**RESUME**” by moving the cursor to this field and pressing the YES/ENTER key. A notification screen displays, and a prompt is given to run the pump. At this time, you can continue to infuse the prescription from the exact point at which it was interrupted.

Note: Patients should be taught proper time frames or limitations for leaving their IV bags or medication reservoirs hanging during an interrupted state and, if indicated, to change to a new bag according to the healthcare provider’s policies and drug manufacturer’s instructions.

Repeating a Pre-Programmed Library Therapy

REPEAT Rx—Use this feature if an infusion is complete and you wish to repeat the same prescription over again or if a therapy is programmed and the pump is turned off before the infusion is started. Select this field by moving the cursor to REPEAT Rx, and press the YES/ENTER key.

If the pump has been programmed for more than one therapy and you wish to select a therapy at this time, move the cursor to REPEAT Rx, and press the YES/ENTER key. This action will take you to the Select Therapy Screen and allow you to choose which of the programs you now wish to repeat.

Note: If you are choosing a therapy that is different than the last one selected, Shift Totals and Hourly Totals will be cleared.

If only one therapy is programmed and REPEAT Rx is selected, the cursor will automatically advance through the prescription menus. You can stop the auto-advance function by pressing any key (except ON/OFF) and then complete the confirmation of the prescription by pressing the YES key at the remaining fields.

Note: REPEAT Rx does not allow any changes to the Pre-Prescription Menu. If changes need to be made in Pre-Prescription selections (units, concentration, etc.) select New Program and reenter the entire prescription.

The lock settings affect the use of REPEAT Rx. Lock 1 allows REPEAT with changes to the prescription screen only. Lock 2 allows REPEAT but does NOT allow the user to make changes in the prescription. Lock 3 does not allow REPEAT. (See lock setting table).

If a therapy has not completed and the REPEAT Rx function is selected, the following screen will display:

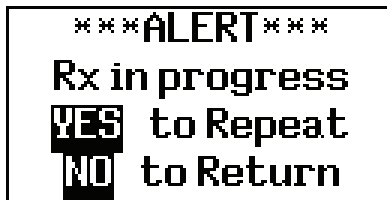

ALERT
Rx in progress
YES to Repeat
NO to Return

If the current infusion is to be discontinued and a new IV bag started, press YES/ENTER to repeat.

If the current infusion is to continue, press NO, and you will be prompted to resume the therapy.

PCA Therapy

The **Moog Curlin Infusion** pump is designed to deliver PCA, or Patient Controlled Analgesia, therapies. It is designed for therapies requiring a continuous rate of infusion, patient controlled boluses, or both. This chapter covers **Moog Curlin Infusion** pumps which can be programmed for PCA-IV, Epidural (EPI) or Subcutaneous (SQ). Programming for each of the three routes of delivery is very similar, although the default programming ranges are specific to each route (see table 5.1). When you begin programming a PCA Therapy, the following display screen will appear, requiring you to enter information needed to program this therapy.

Prescription Menus
PCA Pre-Prescription Menu Screen

UNITS: mg CONCEN: 0.0 mg/ml ADMINRT: IV LOADDOSE: 0.0 mg	UNITS: mcg CONCEN: 0.0 mcg/ml ADMINRT: IV LOADDOSE: 0.0 mcg	UNITS: mL ADMINRT: IV LOADDOSE: 0.0 ml medLMTS: OFF
medLMTS: OFF NEXT? YES	medLMTS: OFF NEXT? YES	NEXT? YES

These menu items allow you to customize the program to match each individual prescription. The pump's default settings are listed in the **left** screen. Each field is individually explained below.

Note: Some of the lines are abbreviated to fit on the display screen. The full descriptions appear below.

1. UNITS: Allows you to select from units of mg, mcg, or mL depending on how the prescription is written. In the PCA-IV therapy, the pump will allow rates as defined in figure 5.1; therefore, if mg or mcg is selected, the concentration requested in the next field will determine the upper and lower programming limits for mg and mcg. Use the NO/CHANGE key until the desired units appears on the display, and then press the YES/ENTER key to accept and move to the next field.
2. CONCEN (Concentration): This field is active whenever mg or mcg is selected in the "Units" field and requires data entry of the concentration of mg or mcg per mL. When the correct data is entered, press YES/ENTER to accept, and move the cursor to the next field. If mL is chosen in the "Units" field, this line will not display. The range for this field is 0.1 to 999.

3. ADMIN Rt (Administration Route): Allows a selection from three routes of administration: the default setting of IV (intravenous), EPI (epidural), and SQ (subcutaneous). If Epidural is selected, the Therapy Identifier bar in the Prescription Menu will display EPI instead of PCA. Each of the routes has defined settings as illustrated in the following table:

Administration Routes

Administration Route	Occlusion Setting mmHg (psi)	Maximum Basal Rate (ml/hr)	Rate During Bolus (ml/hr)	Maximum Bolus Dose (ml)	Maximum Load Dose (ml)
Intravenous	900 or 400 (18 or 8)	9.9	125	9.9	9.9
Epidural	900 or 400 (18 or 8)	25	90	25	25
Subcutaneous	900 or 400 (18 or 8)	5	60	5	5

Figure 5.1 PCA Administration Route Default Settings

4. Load Dose (Loading Dose): Allows the clinician to program in a pre-infusion loading dose if it is prescribed. If a loading dose is not ordered, select the default setting of “0” by pressing YES/ENTER. If it is ordered, enter the dose in this field, and press the YES/ENTER key to accept and move to the next field. The maximum load dose is determined by the administration route (refer to Figure 5.1 above).

IMPORTANT INFORMATION

The amount of drug infused during the “loading dose” depends on the units chosen which may be in mLs, mg, or mcg. A loading dose of 5 mg will infuse 50 mL if the concentration is 0.1 mg/mL.

Note: The units will correspond to the choice previously selected.

The loading dose will be delivered at the fixed bolus delivery rate when the RUN key is pressed to start the PCA infusion. The amount of the loading dose is included in the displayed “Amount Infused” and is logged into the history file. The bolus lockout time is set from the end of the loading dose. Because the loading dose is only used on initial start up of an infusion, it will revert to a value of “0” whenever the “REPEAT Rx” function is selected, or when the pump is powered OFF, before deliver of a loading dose.

IMPORTANT INFORMATION

To terminate a loading dose in progress but save the rest of the prescription, pause the pump and select “REPEAT Rx.” When the RUN key is pressed, the prescription will restart without the loading dose.

5. medLMTS™: (Medication Limitations Prescription): Allows the clinician to setup (clinician or institutional) limits on any medication that is being infused with the pump. If there is no request or mandate to set limits, press YES/ENTER to select the OFF setting and accept the factory defaults. (see Figure 5.1) If a specific medication limit is requested or mandated, press NO/CHANGE to change the OFF setting to ON. Press YES/ENTER to accept the ON setting and the PCA med limitation menu will appear. Enter the appropriate limits for each field:

PCA ↓	medLIMITS SETUP	
	MAX RATE: 0	ms/hr
	△ RATE: 0	ms
	△ TIME: 0:00	HH:MM
PCA ↓	Max BOLUS: 0	ms
	Min INT: 0	MIN
	# BOLUS/hr: 0	
Hi	ACCEPT? YES/NO	

- a. MAX RATE (Maximum Rate) limits: Use the numeric keys to enter the upper limits of the infusion rate. When the correct maximum medLIMIT rate is entered, press YES/ENTER and the cursor will move to the next field. The minimum rate is 0, and the maximum rate must be equal to or less than maximum Basal Rate listed in Figure 5.1 Administration Routes table.
- b. ΔRate (Delta Rate): Some prescriptions include incremental levels or *delta* limitations (e.g., “Do not raise the rate more than 1 mL in 12 hours”). If the prescription has these components, use the ΔRate field and the Δ Time field to enter those limits. Example: Enter the incremental medLIMIT amount level of 1 mL on this field, and press YES/ENTER to move to the next field.
- c. ΔTime (Delta Time): Enter the incremental or delta time limit. (Example: enter 12:00 hours.) If there are no incremental or delta level components to the prescription, leave these fields (ΔRate and ΔTime) set at their default settings of “0” and press YES/ENTER to move to the next field.
- d. Max BOLUS (Maximum Bolus Dose): Use this field to set the upper limit of the Patient Bolus or Patient Demand dose. If there is no bolus dose, enter “0.” If a value is given for the Bolus Dose, use the numeric keys to enter it on this field, press the YES/ENTER key to accept, and move to the next field. The value entered for this field must be equal to or less than maximum Bolus Dose listed in Figure 5.1 Administration Routes table.
- e. MinINT (Minimum Bolus Interval): Use this field to set the minimum amount of time allowed between patient bolus doses. When the correct time is entered, press the YES/ENTER key to accept, and move to the next field.
- f. #BOLS/hr (Number of Boluses allowed per hour): Use this field to enter the maximum patient bolus/hr. When correct, press the YES/ENTER key to accept, and move to the next field.
- g. ACCEPT? If there are any changes to be made, use the up or down arrows to move to that field, use the numeric keys to enter the corrected data, and press YES/ENTER to accept the new values. Move the cursor back to the ACCEPT? field and press

YES/ENTER. The medLMTS™ are now entered and the display returns to the Pre-Prescription screen. If the entire medLMTS™ Setup Screen is to be aborted, press NO to return to the Pre-Prescription screen.

5. NEXT? If any field is not satisfactory, use the arrow keys to locate the field to be changed, enter the changes, press the YES/ENTER key to accept the new values and then go back to the NEXT? field. When all fields are satisfied with correct settings, press the YES/ENTER key to exit this screen, and move on to the next PCA Programming Menu.

At the following screen, the patient's prescription information is entered to complete the programming of the pump for a PCA Therapy. Remember that there may be additional limits to rates and doses based on limits for the route of administration selected. (See Figure 5.1.)

Note that the screen identifier gives the abbreviation "PCA" for Patient Controlled Analgesic Therapy (or EPI if Epidural route is selected) and has a down arrow configuration, which indicates that there are more than four fields of text or information to be considered.

PCA Prescription Menu

BAG Vol: 0.0 ml BASL RATE: 0.0 ml/hr Pt. BOLUS: 0.0 ml BOLS INT: 0 pt MIN	BAG Vol: 0.0 ml BASL RATE: 0.0 mg/hr Pt. BOLUS: 0.0 mg BOLS INT: 0 MIN	BAG Vol: 0.0 ml BASL RATE: 0.0 mcg/h Pt. BOLUS: 0.0 mcg BOLS INT: 0 MIN
#BOLS/hr: 0 DONE? YES		

Note: The PCA therapy can be programmed for Basal Rate (continuous infusion) only, for Patient Bolus (patient demand dose) only, or for both. At least one of these settings must be entered, though, before this menu can be accepted at the "DONE?" prompt.

1. BAG Vol (IV Bag Volume): Using the numeric keys, enter the amount of fluid in the IV Bag or Medication Reservoir (include the overfill volume).

Note: The volume used for priming via the pump is deducted from the Bag Volume. Therefore, Bag Volume should be equal to or greater than the amount to be infused to start the infusion.

When the correct amount has been entered, press the YES/ENTER key to accept this field and move on to the next. The range for this field is 1 to 9999.

2. BASL RATE (Basal Rate): The **Moog Curlin Infusion** pump in PCA Therapy can be set for a continuous basal infusion (see Figure 5.1). Use the numeric keys to enter the prescribed rate (the units chosen in the Pre-Prescription Menu will appear here).

Note: If the rate falls out of the range of the pump (depending on the administration route selected), a beep will sound, and one of the following alert messages will appear:

ALERT GREATER THAN MAX FIELD LIMIT MAX=XX.X	ALERT LESS THAN MIN FIELD LIMIT MIN=XX.X
--	---

This field will not be accepted with the YES/ENTER key until the rate is adjusted to fall within pump's range. When the rate is correct, use the YES/ENTER key to accept, and move to the next field.

3. Pt. BOLUS (Patient Bolus Dose): Use the numeric keys to enter the prescribed bolus (patient demand dose) and when correct, press the YES/ENTER key to accept and move on to the next field. (see Figure 5.1.)

Note: If a bolus dose entered falls out of the range of the pump, the above “Greater than Max Field Limit” or “Less than Min Field Limit” alert will also appear and display the limit.

4. BOLS INT (Patient Bolus Interval): This field allows the clinician to enter the minimum amount of time (from 0 to 60 min) prescribed between patient-activated bolus dosing. Enter the time using the numeric keys and, when correct, press the YES/ENTER key to accept and move the cursor to the next field.
5. # BOLS/hr (Number of Patient Bolus Doses per hour): Using the numeric keys, enter the number (0 to 15) of boluses allowed per hour and, when correct, press the YES/ENTER key to accept and move to the last field.
6. DONE?: If the programming is not done, use the up or down arrow keys to locate the field to be changed, use the numeric keys to enter the corrected information and press YES/ENTER to accept the new data. If all the fields are acceptable, at the DONE? prompt, press the YES/ENTER key to move on to the next screen.

IMPORTANT INFORMATION

Before the infusion is started, it is important to consider a few remaining issues, such as checking the administration set to be sure it was primed or purged of all air, or perhaps the pump may need to be put into a security lock setting for additional safety.

The following screen offers you four choices:

Run Options Screen

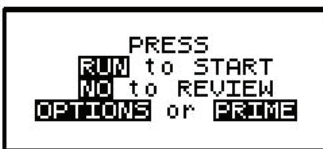

Note that you do not need to answer yes or no questions or enter data as previously requested. This screen requires only that you press the corresponding key on the keypad to begin the requested function. The following section explains each selection beginning with Prime:

Prime

The IV bag or syringes and administration set should be inspected and be free of all air and air bubbles before they are connected to the access site. Priming may have been done by gravity when the administration set was first connected to the bag (see Chapter 2). However, if it was not done then or if there are any remaining air bubbles to be removed, the pump's “PRIME” function will assist in this process. To prime the set by using the pump, follow the directions below.

Note: The lock setting may restrict the ability to prime using the pump.

1. Press and release the PRIME key at the Run Options screen.
2. The following screen appears:

Prime Direction Screen



3. Disconnect the administration set from the patient's access site using aseptic protocols.

IMPORTANT INFORMATION

Priming with the set connected to the patient could result in delivery of air or overdose and may cause injury or even death to the patient.

4. Release any clamps on the administration set.
5. Press and hold the PRIME key. Fluid will be pumped at a rate of 300 mL/hr through the administration set as long as the PRIME key is pressed or until 6 mL is pumped. The pump will then beep once and require repressing and holding the PRIME key again until 6 more milliliters is delivered. Continue this process until all air has been purged from the IV bag and the administration set.

Note: If the bag volume is depleted during priming, a subsequent priming event cannot be initiated.

While the PRIME key is depressed, the following screen appears:

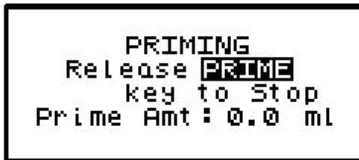

The amount used for the prime session is accumulated and displayed on the bottom field of this screen.

6. When priming is complete, release the PRIME key. The following screen will display:



7. To continue priming, press the PRIME key again. If priming is complete, press YES/ENTER to exit and return to the Run Option screen. The total amount of solution used in this priming session displays on the bottom field.

Note: The amount of fluid used in the priming process will be deducted from the Bag Volume Total but will NOT be counted in the amount infused because this amount is not to be delivered to the patient. The bag volume should still be equal to or greater than the Amount TBI before you can proceed with the infusion. If it is not, an alert will appear stating, “AMT TBI GREATER THAN BAG VOL.” You have the option to continue by pressing the YES/ENTER key or return to the Run Options screen by pressing the NO key.

Options

Once the prescription is programmed, there are more customizing features available for each therapy. Press the OPTIONS key from the Run Options screen to access these options. The OPTIONS menu can also be accessed while the pump is running by pressing the Help/Options key.

Note. After the infusion has started, any changes made through the OPTIONS menu involving:

- “Clin DOSE”,
- “SHFT TOT”
- “HRLY TOT”, and
- “CLR HRLY”

will return you directly to the “ACCEPT OPT?” field.

The following screen displays the PCA Therapy Options available. When you open this menu, use the up and down arrows to move the highlight bar to the desired option. Lock settings may require an access code before the option can be changed. Any new setting, except “CLEAR HOURLY” screen acceptance and “SHIFT TOTAL” clear screen acceptance becomes effective when the Options screen is exited by pressing YES/ENTER at the ACCEPT OPT? field.

P C A O p t i o n s M e n u

<pre> OPTIONS LOCK OFF LOCK: OFF Clin DOSE: OFF SHFT TOT: OFF </pre>	<pre> 1 2 3 ON ON </pre>
<pre> HRLY TOT: OFF CLR HRLY: OFF MedLMTS: OFF DN Occlu: HIGH AIR SENS: 0.5 ml AUDIO: 9 PWRCK? OFF ACCEPT OPT? YES/NO </pre>	<pre> ON ON ON LOW 2.0 OFF 0.1 1 - 9 ON </pre>

Note: The pump’s default settings are indicated above in the **left** screen.

1. **LOCK:** When the lock is set to “OFF,” the clinician has access to all of the pump functions. After the pump is completely programmed, change the lock to meet the security needs of this therapy. There are four choices: “OFF”, “1”, “2”, or “3”. Each level higher limits the available options. To change the lock setting, press the NO/CHANGE key until the correct lock setting appears. Then, press YES/ENTER key to accept the new lock selection. Once the pump has been set into a locked condition, any subsequent request to change the lock will

require a clinician access code. (See “Clinical Information and Access Code” chapter for access code information, lock setting table and available features for each lock setting).

2. ClinDOSE? (Clinician Dose): Allows an additional prescribed dose to be administered by a clinician at any time except during a Load Dose or Bolus Dose. The Maximum Clinician Dose is determined by the administration route (see Figure 5.1.)

Clinician Dose Menu

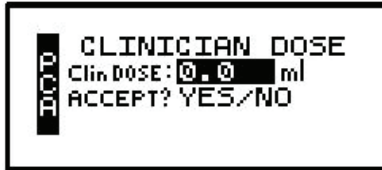

Note: If a lock setting of 1, 2 or 3 is selected, an access code will be requested. If you wish to give a clinician dose at this time, press the NO/CHANGE key to” change OFF to ON change OFF to ON and press YES key. Enter the amount of clinician dose to be delivered. Press YES to accept the clinician dose menu. The Clinician Dose will begin when the options screen is accepted and the pump is running. The following Run Screen will appear until it is completed:



Clinician Dose Run Screen

The graphic bar now depicts the clinician dose in progress and when this dose is complete, reverts back to reflecting the container in progress. **This graphic bar will toggle with Line Pressure (“L Press”) which displays the current patient side (downstream) pressure in the administration set in millimeter of mercury (“mmHg”) units.**

The Volume Infused will toggle with Dose Infused if mg or mcg are the selected unit. Remaining dose time will toggle with remaining dose volume to infuse.

IMPORTANT INFORMATION

When the clinician dose is complete, the pump will return to the previous running rate, and resume the PCA therapy. The lockout time for bolus dosing will restart at the end of the clinician dose to prevent a bolus from being delivered too quickly after a clinician dose.

Once the clinician dose is given, the clinician-dose field returns to its default of 0, and any subsequent clinician doses will need to be reentered.

To Cancel a Clinician Dose:

Press the PAUSE key, to pause the pump and select RESUME. Press the OPTIONS key to access the clinician dose. Press the YES/ENTER key in the clinician dose field and change the dose amount to zero “0”. Press the YES/ENTER key to accept the change and options.

- 3 SHFT TOT (Shift Totals): This feature allows the clinician to track the infusion for a selected period of time, such as an 8 or 12-hour shift. To access Shift Totals, press the NO/CHANGE key to change OFF to ON and then press YES/ENTER. The following screens will appear alternately:

Shift Totals Screens



- Cleared/ELAPSED: This field displays the date and time the shift total was last cleared. It toggles with the amount of time elapsed since that clearing.
 - Vol INF/Amt INF (Volume/Amount Infused): This field displays the volume (mL) and amount (mg or mcg) infused since the shift total was cleared.
 - BOLUS/Clin DOSE (Clinician Dose): This field displays the number of clinician doses given since the total was cleared. It toggles with the number of patient activated boluses received of those requested.
 - To exit the shift total feature without clearing the totals, press the YES key at the highlighted EXIT field.
 - To clear the Shift Totals, press the NO key at the "EXIT" field. The field will change to read "CLEAR," press the "YES" key now to clear. A lock level 3 will require an access code entry before allowing the user to clear the Shift Totals.
- 4 HRLY TOT (Hourly Totals): To view hourly infusion totals press the NO/CHANGE key to change OFF to ON and then press YES/ENTER. Either of the following two screens will appear:

Hourly Totals Screen

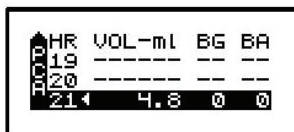

or

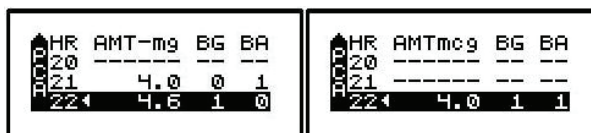

The screen displays hourly infusion delivery for each hour (00-23) of the last 24 hours of therapy in the unit selected.

- The highlighted field has a marker ◀ indicating the current hour in progress.
- "Volume" or "Amount" will show in the first column, "BG" (Bolus Given) in the second column and "BA" (Bolus Attempted) in the third column.
- Use the up arrow key to scroll back through the last 24 hours.
- If the infusion was not running, a series of ----- will appear for that hour.

- e. To exit this screen, press the NO/CHANGE key.
5. CLR HRLY (Clear Hourly Totals): To clear Hourly Totals press the NO/CHANGE key to change OFF to ON and then press YES/ENTER. The following screen will appear:

Clear Hourly Totals Screen

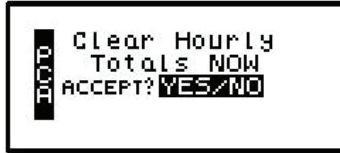

- To clear the Hourly Totals, press the YES/ENTER key. All Hourly Totals will be cleared and the cursor will return to the Options menu.
 - To maintain the Hourly Totals, press the NO/CHANGE key. Hourly Totals will be maintained and the cursor will return to the Options menu.
 - A lock level of 2 or 3 will require an access code entry before allowing Hourly Totals reset.
6. medLMTS™ (Medication Limits): If this feature was **not** selected in the Pre-Prescription Menu, it will not appear on the Options menu. If medLMTS™ parameters were programmed previously, this field will appear; and if you want to titrate now, select ON and press the YES/ENTER key to go to the PCA Titrate medLMTS™ menu:

PCA Titrate medLMTS™ Screen

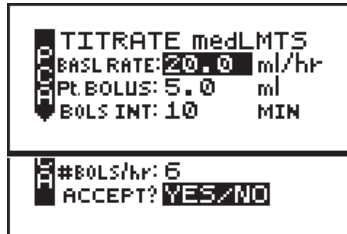

This screen allows you to change the basal rate and/or the bolus parameters within the predefined prescription limits. Whenever any value is changed using the medLMTS™ option, the new value will appear on the prescription menu when it is reviewed. If a delta time/rate limitation was previously programmed, the rate can be increased within those parameters up to 12 times during the delta time period. If a 13th attempt is made an alert will display: “MAX CHANGES FOR PERIOD REACHED.”

- BASL RATE:** Use the numeric keys to enter the new desired rate. When the correct rate has been entered, press the YES/ENTER key to accept the rate, and move to the next field. (see Figure 5.1).
- Pt. BOLUS:** Use the numeric keys to enter the new patient bolus dose and, when correct, press YES/ENTER to accept and move to the next field. (see Figure 5.1.)
- BOLS INT (Patient Bolus Interval):** Use the numeric keys to enter the new patient bolus time interval and, when correct, press YES/ENTER to accept and move to next field. The range for this field is 0 to 60.
- #BOLS /hr (number of patient boluses per hour):** Use the numeric keys to enter the new number of patient boluses per hour and, when correct, press YES/ENTER to move to the

- final step in the medLMTS™ menu. The range for this field is 0 to 15.
- e. ACCEPT? YES/NO: If necessary, use the arrow keys to move to any field and change the data entered. To abort this screen entirely, press NO at this prompt. Any data entered on this display will be aborted and the display will return to the options menu . If the parameters entered are correct, press the YES/ENTER key, and the new rate or rates will be accepted. The display returns to the Options menu when this screen is exited.
 - f. New values will be in effect when the Options menu is accepted.
- 7 DN Occlu (Down Occlusion): This feature allows the pump to sense an occlusion pressure in the line between the pump and the access site, e.g., a kink in the tubing between the pump and the patient, a blockage in the access site, or a clamp left on the distal tubing. There are two options for this field: the “Low” setting triggers the alarm when it detects in-line pressures at 400 mmHg \pm 150 (8 \pm 3 psi “pounds per square inch”), or the “High” setting (default setting) alarms when it detects in-line pressures at 900 mmHg \pm 150 (18 \pm 3 psi). Press the NO/CHANGE key to change the selection. When the correct pressure setting appears, press the YES/ENTER key to accept it and move the cursor to the next field. If setting is changed, the new settings will remain in effect until a new therapy is programmed.
 - 8 AIR SENS (Air In Line Sensor): This feature allows you to select the amount of air the pump will detect in the administration set tubing before it goes into an alarm state. The choices are 0.1 mL, 0.5 mL (the default setting), 2 mL, and OFF. Press the NO/CHANGE key to change the options until the desired setting appears on the display, and then press YES/ENTER to select and move the cursor to the next line. If setting is changed, the settings will remain in effect until a new therapy is programmed.

IMPORTANT INFORMATION

Whenever the Air-In-Line Sensor is set to OFF, Moog Curlin Infusion recommends the use of an air-eliminating filter.

When the Air-In-Line Sensor is set to “OFF” and the RUN key is pressed at the Run Option screen, the alert message below will appear on the screen. It will also appear if the Air-In-Line is changed to “OFF” from the OPTIONS menu when an infusion is in progress and the AIR SENS field is accepted.

Air-In-Line Sensor Off Message Screen



This message alerts you to the Air-In-Line Sensor being set to “OFF.” The message will require answering “YES” or “NO” to whether the administration set being used has an air-eliminating filter. If you press the YES key to indicate that there is an air-eliminating filter in use, the Air-In-Line sensor will be completely disabled and the pump will start the infusion.

If you press the NO key to indicate a filter is not in use, the Air-In-Line sensor will be set to detect the presence of any contiguous 2-milliliter air in the line. The alert message below will then briefly appear on the screen. If the alert occurred at the Run Options screen, the pump will start the infusion.

Pump Will Sense 2mL Alert Screen

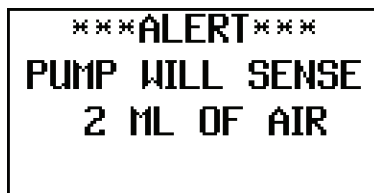

Also, when the Air-In-Line sensor is completely disabled and the infusion goes to an “Infusion Complete” or “Empty Bag” status, the Air Sensor setting will automatically change to 2 mL.

9. AUDIO (Audio Volume): This feature allows you to adjust the audio volume of the pump’s alarm setting. You can enter a number from 9 (the loudest setting) to 1 (the quietest setting). When you select a number, the pump will beep at that audio level. Press the NO key and enter a new setting (1 – 9). Repeat until the desired setting is reached, and then press YES/ENTER to select and move the cursor to the next field.
10. PWR CK? (Power Check): This feature allows you to periodically recheck the battery charge. It will display the active power source of the pump, whether internal batteries or external power. If the active source is the batteries, a graph will indicate approximately how much charge remains in the batteries. To access this information, select ON and press YES/ENTER. The Power Source Screen will display for five seconds and return to the Options Menu.
11. ACCEPT OPT? If the changes made in the Options Menu are acceptable, press the YES/ENTER key. If the changes are not acceptable, cursor up to any field for corrections or abort all changes made in this menu by pressing the NO key, and return to the previous screen.

There are two remaining selections to consider from the Run Options Screen: “NO to REVIEW” and “RUN to START.”

Reviewing or Changing the Program

To review or make any changes in the prescription programming, press the NO/CHANGE key at the Run Options screen, and the prescription screens will reappear (changes may be inhibited by lock setting). Changes to the prescription can be made before the start of the therapy; however, once a therapy has started, no changes can be made to the Pre-Prescription Screen. It will appear only for review purposes. Attempts to change the Pre-Prescription Menu during a new program review will cause an alert screen to be displayed, notifying the programmer that changes will require reprogramming of the prescription.

Starting the Infusion

RUN: When the programming is complete and the pump has been primed properly and connected to the access site, press the RUN key at the Run Option screen to start the therapy. The pump will begin infusing, and except when a Load Dose or Clin Dose is programmed, the following screen will display data on the status of the therapy:

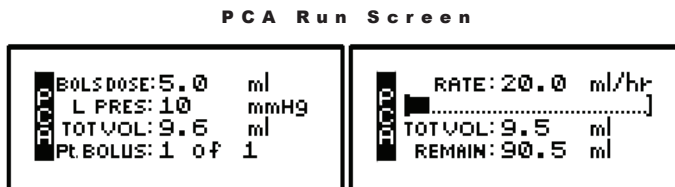

IMPORTANT INFORMATION

The amount of drug infused during the loading dose depends on the units chosen which may be in mLs, mg, or mcg. A loading dose of 5 mg will infuse 50 mL if the concentration is 0.1 mg/mL.

This screen will continue to display as long as the infusion is running. Notice the information on each field:

1. The first field displays the “RATE” of the infusion toggled with the programmed Patient Bolus Dose Amount. This field also displays “BOLUS xx (mg/mL/mcg)” whenever a bolus dose is being delivered. The programmed bolus amount displays and the “BOLUS” text flashes when the pump is delivering a patient bolus dose.
2. The second field is a graphic bar representing the percentage of the completed infusion. **The graphic bar will toggle with Line Pressure (“Line Press”) which displays the current patient side (downstream) pressure in the administration set in millimeter of mercury (“mmHg”) units.**
3. The third line displays the total volume “TOT Vol” infused and, if mg or mcg is the selected unit, this field will toggle to display the total mg or mcg infused “TOT INF” as well.
4. The fourth line displays the number of patient boluses delivered and number of boluses attempted per bag volume. If the patient attempts a bolus before the allowed amount of time set between boluses, an alert message will display “Bolus Requested,” and only the second number will increase. Also, toggling with number of boluses delivered/requested is the remaining volume left in the bag.
5. In addition to the display screen, information on the status of the infusion is provided by the three LED lights. The green LED light blinks whenever the pump is infusing. If the Basal rate is set at 0, the yellow LED light will blink along with the green light until the bolus is actually being delivered. While the bolus is infusing, only the green light will blink.

The information on the run screen will alternate between a four-line display and a large font display of each individual line of information on the screen.

PCA Information Screens

Bolus 0 of 0	Bolus Dose 10.0 mL
Tot Vol 16.9 mL	Rate 10.0 mL/hr
Remain 83.3 mL	Line Pres 10 mmHg

Note: The top line of these running screens will display the name of the running protocol when programmed in the Library mode, or it will display "Unidentified" when programmed outside of the library.

Interrupting an Infusion

The infusion can be paused at any time by pressing the PAUSE key. The yellow STANDBY LED light blinks, and the following screen displays:

Pause Menu Screen



The screen offers the user three options:

Resuming the Current Container

1. RESUME: To resume the therapy in progress from where it left off, press the YES/ENTER key at this field. The pump will return to the Run Options Screen, and you can resume the therapy.

Note: If you wish to hang a new container, move the cursor to REPEAT Rx (see following section).

Run Options Screen

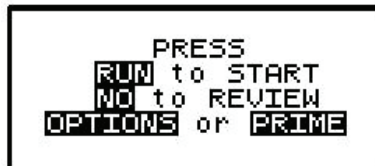

- a. Press the RUN key to resume the therapy.
- b. Press the NO key to go back to the programming screen to make changes in the therapy program (this feature may be blocked by a security lock, thus not allowing changes to the program unless an access code is given). Also, remember that no changes are allowed in the first prescription menu if an infusion is in progress.
- c. Press the OPTIONS or PRIME keys if either of these functions is desired at this time.

Hanging a New Container

2. REPEAT Rx: To repeat the present therapy and add another IV container with the same prescription, press the YES/ENTER key at this field. If more than one therapy is programmed, a Select Therapy Screen will list all preprogrammed therapies. Select which therapy to repeat by moving the cursor to the therapy of choice and pressing the YES/ENTER key.

The pump will then display the program screen with the last programmed values of the therapy and the cursor will automatically advance through the prescription menus. You can stop the auto-advance function by pressing any key (except ON/OFF) and then complete the confirmation of the prescription manually by pressing the YES key at the remaining fields.

Note: The previously programmed AIL setting is also retained

When the program is accepted, the display returns to the above “Run Options Screen.” If the current therapy is still in progress when the “REPEAT Rx” function is selected, the following screen will appear:

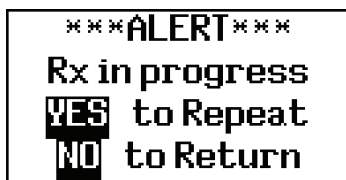

- This screen is a reminder that the infusion is not complete. If the incomplete therapy is to be continued, press NO/CHANGE and the Pause Menu screen will be displayed, then press YES/ENTER and the Run Options screen will be displayed. To resume the unfinished therapy, press RUN.
- If the therapy is to be terminated and a new IV container added, press YES/ENTER to repeat the infusion. The following screen will then appear, asking whether or not you wish to maintain the current “Bolus or MedLMTS™ schedule.”

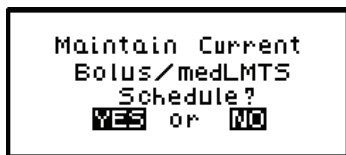

Press YES/ENTER to maintain the current schedules and continue with the programming of the pump. Press NO/CHANGE to start a new schedule. The following screen will then appear asking you to confirm the clearing of the schedules.

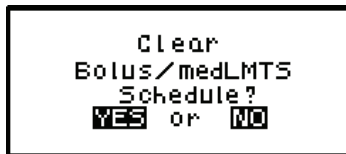

Press YES/ENTER to clear the current schedules and continue with the programming of the pump. Pressing NO/CHANGE will return you to the prior screen.

Entering a New Program

3. **NEW PROGRAM:** To program an entirely new prescription or different therapy, press the YES/ENTER key at this field (the ability to change these parameters may be controlled by the lock setting). The display will return to the Pre-Prescription Screen. If the current container has not completely infused, the following screen will appear:

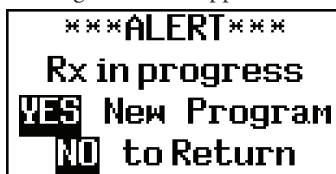

- This screen is a reminder that the infusion is not complete. If you want to return to the current container and finish infusing it, press the NO/CHANGE key to return to the Pause Menu screen.
- To abort the current container and enter a new program, press the YES/ENTER key. If a prescription has previously been entered for the therapy mode you wish to program, the following screen will appear:

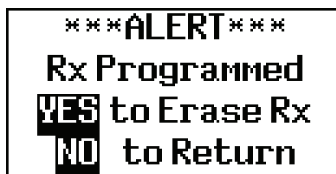

- If you want to save the current prescription, press the NO/CHANGE key to return to the Pause Menu screen. If you wish to erase the current prescription and enter a new program, press the YES/ENTER key to proceed. All previous prescription values will be erased.

Note: Selecting “NEW PROGRAM” will also reset the “OPTIONS” selected to their default settings except for the “LOCK” and “AUDIO” settings which must be changed manually.

Infusion Complete

When the infusion is complete, the audio alarm will beep, and the following screen will display:

Note: To temporarily silence the alarm, press the SILENCE key.

PCA Infusion Complete

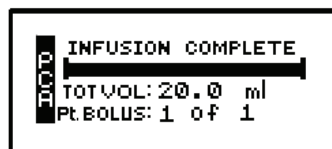

This screen displays:

- “INFUSION COMPLETE.”

2. A completely filled in bar graph indicating infusion complete.
3. TOT Vol (Total Volume): If units are mg or mcg, this field will also toggle to give the “Total Infused.”
4. “Infusion Complete” is considered an alarm status, and the audio alarm will beep periodically every three seconds to alert the user to this condition. Additionally, the red LED light blinks to indicate that the “Infusion Complete” alarm exists.

Stopping the Infusion

At “Infusion Complete,” press the PAUSE key and then choose to either:

1. Turn off the pump by pressing the OFF key, or
2. Select one of the options from the Pause screen:

Pause Menu Screen



- a. REPEAT Rx: To repeat the present therapy and add another IV container with the same prescription, press the YES/ENTER key at this field. The following screen will then appear, asking whether or not you wish to maintain the current “Bolus or MedLMTS™ Schedule.”

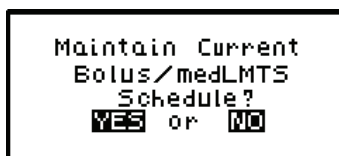

Press YES/ENTER to maintain the current schedules and continue with the programming of the pump. Press NO/CHANGE to start a new schedule. The following screen will then appear asking you to confirm the clearing of the schedules.

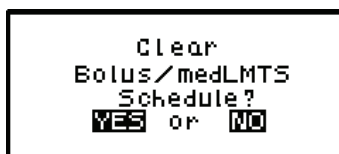

Press YES/ENTER to clear the current schedules and continue with the programming of the pump. Pressing NO/CHANGE will return you to the prior screen.

The pump will then display the program screens with the last programmed values of the therapy and the cursor will automatically advance through the prescription menus. You can stop the auto-advance function by pressing any key (except ON/OFF) and then complete the confirmation of the prescription manually by pressing the YES key at the remaining fields.

b. NEW PROGRAM: To program an entirely new prescription press the YES/ENTER key when this field is highlighted and the display will return to the Select Therapy Screen. (The lock setting can control access to this function.)

Note: The therapy is complete; therefore, “RESUME” is not an option at this time and is not displayed.

Troubleshooting

*This section assists in identifying and resolving alert and alarm conditions that may occur during the use of the **Moog Curlin Infusion pump**.*

IMPORTANT INFORMATION

Alerts, Alarms, and Error Codes

Alerts, Alarms, and Error Codes are classes of events that are relayed to the user and logged into the history file. The screen will display messages, the LED status lights will blink, and the audio alarm will sound. The backlight feature will illuminate the screen during an alert or alarm.

If the batteries have been dislodged or are so low in power that they cannot operate the pump, a solid tone may occur accompanied by a blank display screen and a constant red alarm light. In this event, replace the batteries.

ALERTS

Alerts report conditions that require attention from the user but may not be safety issues. When an alert occurs, a message is displayed on the LCD screen, and the audio alarm is sounded. The message displays on the screen for three seconds if it is a user-initiated alert, such as a wrong key press. If it is an automatic alert occurring while a therapy is infusing, such as “low battery,” the message displays for twenty seconds. If it is an alert that requires a user response, the alert remains displayed until the user presses one of the keys specified on the screen. The following is a list of the alerts in alphabetical order.

LCD Display:	***ALERT *** AIR Sensor OFF. Using In Line Air Filter?
Alert:	Air-In-Line Sensor Disabled
Cause:	The Air-In-Line Sensor has been disabled and either the RUN key has been pressed to run an infusion or the AIR SENS setting has been set to OFF on the Options menu while the pump is running.
Resolution:	If an air-eliminating filter is being used, press YES. The infusion will start/resume and the No Air-In-Line sensitivity will be disabled until the empty bag alert occurs or infusion complete is reached. No Air-In-Line alarms will occur while the air sensitivity is disabled. If no air-eliminating filter is being used, press NO. The infusion will start/resume and the Air-In-Line sensitivity will be set to 2 mL for the

remainder of the infusion.

Note: If the screen is not acknowledged with a YES or NO key press, the Air-In-Line sensitivity will be set to 2 mL when the screen is cleared (i.e. alarm occurs while screen is displayed).

- LCD Display:** ***ALERT *** AIR SENSOR HAS BEEN SET TO 2 ML
Alert: Air-In-Line sensitivity will be set to 2mL
Cause: NO was pressed at the “AIR SENS OFF. Using In Line Filter?” alert screen. The Air-In-Line sensitivity will be set to trigger an Air-In-Line alarm if 2mL of air is detected.
- Resolution:** If an air eliminating filter is being used, press YES when the “AIR SENS OFF. Using In Line Filter?” screen is displayed. This will disable air detection as indicated under “AIR SENS OFF. Using In Line Filter?” alert explanation.
- LCD Display:** ***ALERT *** AMT NOT 0 OR CURRENT DOSE AMT
Alert: Unable to change clinician dose while clinician dose in progress
Cause: A clinician dose is in progress, and a new clinician dose value is entered that is not 0 or the current dose amount.
- Resolution:** If the current clinician dose is to be continued, change the “Clin DOSE” value
back to the original value and accept the field and menu.
If the current clinician dose is to be terminated, which will allow a new clinician dose to be programmed, enter a value of 0 in the “Clin DOSE” field and accept the field and menu. The next time that the Options menu is accessed a new “Clin DOSE” value can be entered.
- LCD Display:** ***ALERT *** AMT TBI GREATER THAN BAG VOLUME
Alert: Value entered is greater than value in “Bag Vol” field.
Cause: Occurs when the amount the entered for the “Amt TBI” or “Vol TBI” field is greater than the value in the bag volume field.
- Resolution:** Recheck the data entry.
- LCD Display:** ***ALERT *** AMT TBI GREATER THAN BAG VOLUME. YES to
Continue NO to Return
Alert: Insufficient volume

- Cause:** Occurs when bag volume is less than amount to be infused. Can also occur when pump's priming feature is used and bag volume is depleted by the amount used in priming.
- Resolution:** To modify the Bag Volume or "Amt/Vol TBI," press NO to return to the Run Options screen. The programming screens will then be accessible by pressing NO to review on the Run Options screen.
Note: Access to the programming screens is lock level restrictive. If the actual amount in the source bag/container is sufficient to complete the programmed infusion, press YES to start the infusion.
Note: If the infusion is continued without sufficient volume, Air-In-Line or Up Occlusion alarms may occur later in the infusion.
- LCD Display:** ***ALERT *** BASAL RATE EQUAL OR GREATER THAN BAG VOL
Alert: Value entered is greater than or equal to the value in "Bag Vol" field.
Cause: Occurs when the amount the entered for the "Basal Rate" field is greater than or equal to the value in the bag volume field.
Resolution: Recheck the data entry.
- LCD Display:** ***ALERT *** AMT TBI LESS THAN AMT INFUSED
Alert: Unable to change amount to be infused to an amount less than what has already infused.
Cause: Occurs when user tries to change the "Vol TBI / Amt TBI" field in the prescription menu to an amount lower than the amount which has already infused.
Resolution: Recheck the data entry. If alert recurs, resume the infusion and observe the Vol Inf / Amt Inf field on the run menu. The value for data entry must be greater than the value displayed on the run menu.
- LCD Display:** ***ALERT *** BOLUS DOSE IS NON-ZERO
Alert: Unable to enter a bolus interval or # of boluses/hour of 0
Cause: Bolus interval or # of boluses/hour value entered is zero, and bolus dose value is non-zero. When a bolus value is entered, there must also be a value greater than 0 entered for bolus interval and # of boluses/hour.
Resolution: Recheck data entered for the prescription.
- LCD Display:** ***ALERT *** BOLUS DOSE NOT ALLOWED
Alert: A bolus dose is not allowed
Cause: BOLUS key or button pressed when no bolus dose is programmed.
Resolution: If bolus doses are part of the prescription, modify the Rx/medLMTS™ program to allow bolus doses.

LCD Display:	***ALERT *** BOLUS REQUESTED
Alert:	Not time for bolus
Cause:	BOLUS button or key is pressed before the programmed time interval between bolus doses have elapsed.
Resolution:	Advise patient of time limits between bolus doses per agency protocols.
LCD Display:	***ALERT *** CALCULATED AMT OUT OF RANGE
Alert:	Invalid calculated amount for infusion
Cause:	The calculated amount for the infusion, based on the values entered for rate and time, exceeds either the pump limit or the value entered for bag volume.
Resolution:	Recheck data entry for Rx.
LCD Display:	***ALERT *** CALCULATED RATE OUT OF RANGE
Alert:	Invalid calculated rate of infusion
Cause:	The calculated rate for the infusion, based on the values entered for Volume/Amount and Time, exceeds either the minimum or maximum rate limit of the pump or the maximum rate programmed in medLMTS™.
Resolution:	Recheck data entry for Rx.
LCD Display:	***ALERT *** CALCULATED TIME OUT OF RANGE
Alert:	Invalid calculated time
Cause:	The calculated time for the therapy, based on the values entered for Volume/Amount and Rate, exceeds the therapy time limit of 288:00 HH:MM (167:59 HH:MM Software Versions below R37C).
Resolution:	Recheck data entry. The time calculated by the pump cannot exceed the pump range.
LCD Display:	***ALERT *** CHANGES REQUIRE REPROGRAMMING. YES to Continue NO to Return
Alert:	Changes to the data will require re-entry of prescription.
Cause:	Attempted to change the Pre-Prescription Screen prior to start of infusion.
Resolution:	If a change to the programmed prescription is required, press "YES". Note: Selecting YES will clear the <u>entire</u> prescription and require <u>re-entry</u> of the prescription. If no change is required, press NO to preserve the current prescription and return back to the Pre-Prescription screen.
LCD Display:	***ALERT *** DATE/TIME CHANGE NOT ALLOWED
Alert:	Not allowed to change date or time.
Cause:	Attempt made to modify system clock while a therapy/delay is in progress.
Resolution:	If the therapy in progress is to be continued, wait until the infusion is complete and then change the date and time.

If it is not necessary to preserve the therapy in progress or any other programmed therapy, use the “CLEAR Rx” feature of the Clinician BioMed menu. This feature will erase all programmed therapies in the pump. The date and time can then be changed.

If the therapy is to be terminated but the prescription preserved (excluding Delayed Start), go to the Pause menu, select “REPEAT Rx” and press YES at the “Rx in progress” alert screen. The pump can then be turned off and then on to access the Date/Time change option in the Clinician BioMed menu. Selecting “NEW PROGRAM” and the name for the therapy in progress, instead of “REPEAT Rx”, may also be used but this selection will erase the prescription for the therapy.

- LCD Display:** ***ALERT *** DATE/TIME INVALID
Alert: Unable to enter invalid date or time
Cause: Date or time entry is not in a valid format.
Resolution: Recheck data entry. An invalid date or time will not be accepted.
- LCD Display:** ***ALERT *** DELAY START TIME NOT VALID
Alert: Delay Start Time not valid
Cause: Delay start time entered is less than one minute or greater than 24 hours from the current system time.
Resolution: Reset Delay Start Time to fall within pump limits. (To obtain the current date and time of the pump, turn the pump off and then on and observe the time on the Welcome Screen.)
- LCD Display:** ***ALERT *** DOOR OPEN or SET NOT PROPERLY INSTALLED
Alert: Door Open or Administration Set is not properly installed.
Cause: Door Latch is not completely closed or the Administration Set is not installed according to installation instructions.
Resolution: Recheck the door latch assembly and securely close the door. If the door was closed properly, re-install the set according to the installation instructions.
- LCD Display:** ***ALERT *** DOSE AMT IS LESS THAN DOSE INFUSED
Alert: Dose amount entered is less than the amount already infused for the dose.
Cause: New dose value entered is less than the amount already infused for the dose.
Resolution: Recheck data entry. After the dose in progress finishes, the dose amount may be changed to the lower value.
 If the above is not suitable, re-program the prescription.
- LCD Display:** ***ALERT *** DOSE CANCELLED, RESUME INFUSION, THEN NEW DOSE

Alert:	Cancellation of a clinician dose is pending and can only be processed with the pump running.
Cause:	Clinician dose in progress is canceled while the infusion is paused; and the user attempts to enter a new Clinician Dose, prior to resuming the infusion
Resolution:	Resume the infusion and then program the desired Clinician Dose.
LCD Display:	***ALERT *** DOSE FREQ LESS THAN DOSE DURATION
Alert:	Dose frequency time is less than the time required to infuse the programmed dose.
Cause:	The dose frequency value entered is less than the time required to infuse the programmed dose amount.
Resolution:	Recheck data entry. Dose frequency cannot be less than required time for dose to infuse.
LCD Display:	***ALERT *** EMPTY BAG
Alert:	Empty Bag
Cause:	Occurs when the volume infused for the prescription is equal to the “Bag Vol.” Bag volume may have been reduced due to priming.
Resolution:	Verify that the volume remaining in the source container is sufficient to complete the current therapy. If the volume is insufficient, add another source container or stop the infusion.
LCD Display:	***ALERT *** EXCEEDS POSSIBLE DOSES PER HR
Alert:	Unable to enter # of boluses/hr that would be possible given the programmed bolus amount.
Cause:	# Boluses/hr value exceeds the possible # given the bolus amount.
Resolution:	Recheck data entered. The # of boluses per hour cannot exceed the time required to deliver the bolus amount programmed.
LCD Display:	***ALERT *** EXTERNAL POWER DISCONNECTED
Alert:	External power source disconnected.
Cause:	External power source is disconnected or external battery pack power is completely depleted during pump operation.
Resolution:	Reestablish external power source, or let pump continue to operate on batteries. Note: The battery level should be checked after the external source is disconnected to gage if additional batteries will be required before an external power source is available again.
LCD Display:	***ALERT *** FIELD NOT ACCEPTED
Alert:	Field Not Accepted.
Cause:	The field indicated by the flashing cursor has not been accepted.

- Resolution:** Recheck the field and accept it by pressing the YES/ENTER key.
- LCD Display:** ***ALERT *** GREATER THAN MAX FIELD LIMIT, MAX = _____
- Alert:** Unable to program a field with a value that exceeds the maximum limit
- Cause:** Value entered is greater than the allowable limit.
- Resolution:** Recheck data entry. A value entered cannot exceed the field limit.
-
- LCD Display:** ***ALERT *** GREATER THAN WHAT BOLS INT ALLOWS
- Alert:** Unable to enter a # of boluses/hr that exceeds the possible number allowed given the bolus interval.
- Cause:** # Boluses/hr value exceeds the possible number given the bolus interval (“BOLS INT”) programmed.
- Resolution:** Recheck data entry. The # of boluses/hr cannot be set for higher than the number allowed using the given bolus interval.
-
- LCD Display:** ***ALERT *** INFUSION NOT IN PROGRESS
- Alert:** Infusion not in progress.
- Cause:** Modification attempted to Next Dose or Early Down Ramp field without an infusion in progress.
- Resolution:** Wait until infusion is in progress before modifying or modify original Rx programmed.
-
- LCD Display:** ***ALERT *** INSUFFICIENT VOLUME MAX DOSES= _____
- Alert:** Bag Volume value is insufficient to deliver the remaining
- Cause:** Occurs whenever the prescription is changed so that bag volume is now less than amount required for the entire therapy (based on volume already infused plus volume required to deliver the remaining doses).
- Resolution:** Recheck data entry. If the source container contains sufficient volume to complete the remaining dose cycles (dose volume + KVO volume), increase the “Bag Vol.” If the volume is insufficient, decrease the “DOSE/BAG” such that the therapy can continue with the new modified prescription.
- Note:** If either “Bag Vol” or “DOSE/BAG” is modified and the therapy is repeated, these fields will have to be verified against the source container volume and prescribed prescription and changed accordingly.
-
- LCD Display:** ***ALERT *** INVALID ENTRY
- Alert:** Invalid Entry
- Cause:** Data entered does not fall within the defined limits of the program.
- Resolution:** Enter data that falls within the limits of the program. Refer to the specific therapy section in the User’s Manual.
-
- LCD Display:** ***ALERT *** KVO RATE IS GREATER THAN INF RATE

Alert: Unable to enter KVO rate that is greater than infusion rate
Cause: Occurs when user enters a KVO rate that is greater than infusion rate.
Resolution: Recheck data entry. KVO rate must be less than programmed or calculated infusion rate.

LCD Display: ***ALERT *** LESS THAN MIN FIELD LIMIT, MIN = _____
Alert: Unable to program a field with a value that is less than the minimum limit.
Cause: Value entered is less than the minimum limit for the pump or medLMTS™ programmed.
Resolution: Recheck data entry. A value entered cannot be less than the field's minimum limit.

LCD Display: ***ALERT *** "LOW C BATTERIES"
Alert: Battery source power is low.
Cause: The batteries that are powering the pump have reached levels that may prevent the continued operation of the pump beyond 1 hour (actual time is rate dependent). Alert applies only to C-cell batteries, not to the rechargeable battery pack.
Resolution: PAUSE the therapy in progress, turn the pump "OFF"; and then replace the batteries. (See chapter 1 of the User's Manual for instructions on battery change.)

LCD Display: ***ALERT *** MAX CHANGES FOR PERIOD REACHED
Alert: The maximum number of changes for the current delta time window has been reached.
Cause: The maximum number of pump rate changes for the current delta time window has been reached. This occurs when the rate has been changed more than 12 times during any delta time window.
Resolution: Allow more time to elapse before attempting to change the rate or reprogram the therapy with medLMTS™ and prescription basal and bolus ranges that will reduce the number of times that the rate will have to be adjusted.

LCD Display: ***ALERT *** MODIFICATIONS NOT ALLOWED
Alert: Modification Not Allowed.
Cause: The selection cannot be modified at this time or the programmed lock setting does not permit modifications to this selection.
Resolution: Review the User's Manual for program restrictions or if lock level restricted, change lock setting to access area you wish to modify.

LCD Display: ***ALERT *** NEW DOSE IS LESS THAN CURRENT DOSE
Alert: Unable to program a lower number of doses than number of doses already infused.

Cause: While the Variable or Intermittent therapy is in progress, a lower number of doses to be delivered is entered than the number already infused.

Resolution: Wait until current therapy in progress is complete, or pause pump and, using the 'REPEAT Rx' function, modify the number of doses.

Note: Selecting to repeat the therapy in progress will terminate the current therapy.

LCD Display: ***ALERT *** NO BOLUS DOSE DEFINED

Alert: Unable to enter bolus interval or # of bolus/hr because no bolus value has been programmed.

Cause: Entry of a value other than zero for the Bolus Interval or “#Bolus per hour” field when no bolus value has been programmed.

Resolution: Enter bolus value before entering bolus interval or # of boluses/hr.

LCD Display: ***ALERT *** NO KEYPAD ACTIVITY

Alert: No Keypad Activity.

Cause: The pump has been displaying a non-running screen for two minutes without any keys being pressed. The alert will recur every 2 minutes as long as there are no key presses.

Resolution: Complete the activity for the displayed menu. The pump may also be turned off, however, all programming that was not complete will be discarded. If the pump was running and the Options menu displayed when the alert occurred, the run screen for the therapy will be displayed when the alert is cleared. Any changes to the Options menu are discarded and will have to be re-entered.

LCD Display: ***ALERT *** NO THERAPY ENABLED

Alert: No Therapy Enabled.

Cause: Attempting to accept the Enable Therapy menu with all therapies set to “OFF.” At least one therapy must be enabled or “ON” for menu to be accepted.

Resolution: Enable the therapy or therapies that are to be active for the pump.

LCD Display: ***ALERT *** NOT ALLOWED, DOSE IN PROGRESS

Alert: Change is not allowed while a dose is in progress.

Cause: Modification to the current field is not allowed while the dose is in progress.

Resolution: Wait until the dose in progress completes before modifying field.

LCD Display: ***ALERT *** NOT in PCA. NO BOLUS ALLOWED

Alert: Bolus requested when therapy is not PCA.

Cause: Remote Bolus button or BOLUS key is pressed when not in PCA therapy.

Resolution:	Remove the remote bolus cord from the pump if connected. Refrain from pressing the BOLUS key.
LCD Display:	***ALERT *** NUMBER OF DOSES INVALID
Alert:	Number of doses entered exceeds maximum for therapy
Cause:	The number of doses per bag in Intermittent therapy exceeds the allowable maximum.
Resolution:	Recheck data entry. The number of doses requested must be less than or equal to the maximum for the therapy.
LCD Display:	***ALERT *** PERFORM ROUTINE MAINTENANCE
Alert:	Maintenance Date (displayed only if date has arrived when pump is turned on)
Cause:	Current Date is beyond the maintenance date.
Resolution:	Return pump for routine maintenance.
LCD Display:	***ALERT *** RAMP INVALID FOR AMT/RATE
Alert:	Ramp time entered is invalid for amt/rate already programmed
Cause:	Ramp value entered for TPN is unacceptable given the desired rate and amount programmed.
Resolution:	Recheck all data entered for prescription. If programming a new TPN therapy (“NEW PROGRAM” selected) and the ramp time is a requirement, enter the ramp time(s) and total time first followed by the next governing parameter (rate or volume to be infused).
LCD Display:	***ALERT *** RATE EXCEEDS DELTA RATE/DELTA TIME
Alert:	Rate entered exceeds the delta time limits
Cause:	The rate entered falls outside of the allowable range for the delta rate / delta time limits programmed.
Resolution:	Recheck data entry or wait more time elapses then attempt to change the rate. Rate selected cannot exceed the range placed on medLMTS™.
LCD Display:	***ALERT *** RUNNING, PAUSE PUMP PRIOR TO PRESSING OFF
Alert:	Pause Infusion before turning off
Cause:	The OFF key was pressed while the pump was infusing or a running screen displayed.
Resolution:	Press PAUSE key before pressing OFF key to stop an infusion.
LCD Display:	***ALERT *** Rx IN PROGRESS, YES to Repeat – NO to Return
Alert:	“REPEAT Rx” selected while a therapy is already in progress
Cause:	“REPEAT Rx” was selected and there is a therapy currently in progress.

- Resolution:** To terminate the current therapy in progress, press YES. Resume will no longer be available. The Select Therapy menu will be displayed (if only one therapy is in programmed, the pre Rx menu for the therapy will be displayed). When the therapy to repeat is chosen, the last prescription data programmed will appear in the menu, excluding Delayed Start and Load Dose (if therapy was previously started). When the infusion is started the entire therapy will be repeated.
To continue the current therapy in progress, press NO. The Pause menu will be displayed.
- LCD Display:** ***ALERT *** Rx IN PROGRESS, YES New Program – NO to Return
Alert: “NEW PROGRAM” was selected while a therapy is already in progress.
Cause: “NEW PROGRAM” was selected and there is a therapy currently in progress.
Resolution: To terminate the current therapy in progress, press YES. Resume will no longer be available. The Select Therapy menu will be displayed (if only one therapy is in programmed, an alert screen informing that the Rx will be erased will be displayed). When the therapy for the new program is chosen, entry of a new prescription will be required.
To continue the current therapy in progress, press NO. The Pause menu will be displayed.
- LCD Display:** ***ALERT *** Rx Programmed, YES to Erase – NO to Return
Alert: “NEW PROGRAM” was selected for a therapy that has an existing prescription.
Cause: “NEW PROGRAM” was selected for a therapy that has an existing prescription.
Resolution: To erase the prescription for the selected therapy, press YES. The pre Rx menu will be displayed and entry of a new prescription will be required.
To preserve the prescription for the selected therapy, press NO. The Pause menu will be displayed.
- LCD Display:** ***ALERT *** SET NOT INSTALLED
Alert: Set Not Installed.
Cause: Administration set is not properly installed.
Resolution: Install the appropriate **Moog Curlin Infusion** administration set for the desired therapy. Use *ONLY Moog Curlin Infusion* administration sets. See Chapter 2 figures 2.9 and 2.10 of the User’s Manual for proper installation of the administration set.
- LCD Display:** ***ALERT *** SYSTEM CLOCK NOT SET
Alert: System Clock Not Set.
Cause: The clock for the pump is not set

Resolution:	Use the BioMed SETUP menu Date and Time option to set the date and time.
LCD Display:	***ALERT *** THERAPY TIME INVALID
Alert:	Invalid therapy time calculated.
Cause:	While programming or modifying an Intermittent therapy, the combination of dose duration and dose frequency result in a prescription with a duration greater than 288:00 HH:MM.
Resolution:	Recheck data entry. The changes to the field must comply with the total time limit.
LCD Display:	***ALERT *** TIME LESS THAN RAMP TIME
Alert:	Unable to enter a TPN therapy time that is less than the ramp times.
Cause:	Time value entered for TPN infusion is less than ramp times.
Resolution:	Recheck data entry. TPN infusion time cannot be less than specified ramp times.
LCD Display:	***ALERT *** VALUE PREVENTS A SUBSEQUENT DOSE
Alert:	Value entered will prevent the ability to program any more doses.
Cause:	The value entered for the “Variable Dose Amt” or “Time” field will cause no remaining amount or time for a subsequent.
Resolution:	Recheck data entry. If this is a new program, reprogramming of the therapy will be required if the error is in a previously programmed dose. If the therapy is in progress or this is a repeat program that has not started and the error is in a previously programmed dose, turn the pump off and then on. Choosing to resume or repeat the therapy will display the last prescription that was completely programmed.
LCD Display:	***ALERT *** EMPTY LIBRARY
Alert:	Empty Library
Cause:	Occurs when “LIBRARY” is selected and no library is present.
Resolution:	Load a Library or program the pump using the “PROGRAM” option.
LCD Display:	***ALERT *** PUMP DISABLED CALL PROVIDER
Alert:	The pump is disabled
Cause:	The pump calibration data is invalid.
Resolution:	The pump needs to be returned for service.
LCD Display:	***ALERT*** DOOR OPEN or SET NOT PROPERLY INSTALLED
Alert:	Door is opened or administration set is not properly installed while the pump is running

Cause: Door is opened or administration set is not properly installed while the pump is running

Resolution: Check the door latch assembly and securely close the door. If the door was closed properly, re-install the set according to the installation instructions. See Figure 1.8 for instructions on closing door.

ALARMS

Alarms are conditions that require correction by the user and may be a safety issue but are not system errors of the pump. All alarm conditions stop the infusion. The only exception to this rule is at the “Infusion Complete” alarm, which allows the KVO rate, when programmed, to continue infusing. When an alarm occurs, a message is displayed on the screen, the audio alarm is sounded, and the red LED light flashes. The message stays on the screen until the pause key is pressed. The SILENCE key can be pressed to disable the audio alarm for one-minute intervals. The cause of the alarm must be resolved, or the alarm will recur when the infusion is restarted. To exit an alarm screen, press the PAUSE key, resolve the alarm condition, and then resume the therapy by selecting “RESUME” from the Pause Menu.

The following is a selected and alphabetical list of the alarms, conditions that cause the alarms, messages displayed on the screen, and actions necessary to resolve them:

LCD Display: ***ALARM*** AIR IN LINE

Alarm: Air-In-Line

Cause: Pump has detected air in the administration set during an infusion.

Resolution: Check air settings and remove air from administration set and IV bag or reservoir per protocol. (Disconnect from patient’s access site before using prime function.)

LCD Display: ***ALARM*** DOWN OCCLUSION

Alarm: Occlusion between pump and patient access site

Cause: Pump has detected excessive pressure in the administration set between the pump and the patient’s access site.

Resolution: Check administration set from pump to patient access site for potential causes of occlusion. If tubing is kinked, straighten it. If filter is blocked, replace administration set. If patient access is obstructed, check it according to protocol. Consider changing the down occlusion pressure setting from low to high. If the occlusion is cleared without the need to open the pump door, the pump automatically resumes its operation. Note: If the door of the pump is opened to clear the occlusion, (e.g. replacing the set), you must press the PAUSE key, select “Resume,” and then press the RUN key to restart the infusion.

LCD Display: ***ALARM*** EMPTY BATTERY

Alarm: Empty Battery

Cause: The C-cell battery no longer has sufficient power to run the pump. Alarm will not be displayed when external battery pack is depleted.

Resolution: Turn the pump off. Replace both of the C-cell batteries. Recharge or replace the battery pack if applicable.

LCD Display: ***ALARM*** HIGH UP PRESSURE

Alarm: High positive pressure between the pump and IV reservoir.

- Cause:** The pump has detected excessive positive pressure between the pump and the IV Source.
- Resolution:** Press PAUSE to clear alarm screen. Check for excessive pressure on the IV bag and relieve it. When ready to begin infusion, select “RESUME.”
- LCD Display:** ***ALARM*** REPLACE SET 3
- Alarm:** Replace Set
- Cause:** The pump has detected that the disposable administration set must be replaced.
- Resolution:** Replace the disposable administration set, prime the set if necessary, and when ready to begin infusing, select “RESUME” to continue the infusion.
- LCD Display:** ***ALARM*** REPLACE SET 4
- Alarm:** Replace Set
- Cause:** The pump has detected excessive pressure in the disposable administration set.
- Resolution:** Make sure that all the IV clamps are open. Relieve pressure, open and close pump door.
- LCD Display:** ***ALARM*** SET NOT INSTALLED
- Alarm:** Administration Set Not Installed.
- Cause:** The administration set has not been installed or has been installed improperly.
- Resolution:** Install appropriate **Moog Curlin Infusion** Administration set for desired therapy. Use ONLY **Moog Curlin Infusion** Administration sets. If the blue tubing guide on the administration set has been damaged in any way, replace the entire administration set. See Chapter 2, Figures 2.9 and 2.10 for proper installation of administration set.
- LCD Display:** ***ALARM*** UNATTENDED PUMP
- Alarm:** No key presses have occurred while the pump was paused
- Cause:** When a therapy is in progress and a pump is placed in a paused state and left unattended for more than two minutes, this alarm will sound. If the prime menus are left unattended for one minute, this alarm will sound
- Resolution:** Press the PAUSE key to clear the alarm screen. If required, return to the screen displayed at the time of the alarm and complete the activity that was in progress, or resume the infusion, or turn the pump off.
- LCD Display:** ***ALARM*** UP OCCLUSION
- Alarm:** Negative pressure detected between the pump and IV reservoir.
- Cause:** Pump has detected excessive negative pressure in the administration set between the medication reservoir or IV bag (“up stream”) and the pump.

Resolution:	Pause the pump. Check administration set from IV bag to pump for potential causes of occlusion. Open the door of the pump and remove the administration set from the pumping chamber. If an area of the tubing is flattened, massage that area to a more rounded shape. If a clamp is in place, open it; if tubing is kinked, straighten it. Replace administration set back in the pump. When ready to begin infusing, select “RESUME.” If the alarm continues, use a new administration set or if the IV bag is almost empty, replace it.
LCD Display:	COMM TIMEOUT
Alarm:	Communication Timeout occurred during Pump/CMS communication.
Cause:	The communication link between the pump and the PC running CMS was broken (i.e., the cable between them was unplugged) during a CMS upload to the pump
Resolution:	Check the cable connection between the pump and the PDA or PC.
LCD Display:	INFUSION COMPLETE
Alarm:	Infusion Complete
Cause:	Programmed “Amount to be Infused” is depleted to 0.
Resolution:	If the therapy is to be repeated, press PAUSE, add another IV bag or reservoir and select the “REPEAT Rx” function. If the therapy will not be repeated, press PAUSE key and turn the pump off by pressing the OFF key.
LCD Display:	STUCK BOLUS KEY
Alarm:	Bolus Key is stuck.
Cause:	The Remote Bolus Cord is not functioning correctly
Resolution:	Replace the Remote Bolus Cord.
LCD Display:	***ALARM *** LOW MOTOR SUPPLY
Alarm:	Low Motor Supply Voltage
Cause:	The voltage to the motor supply is too low
Resolution:	Connect the AC adaptor or replace the batteries.
LCD Display:	***ALARM *** MOTOR STALLED
Alarm:	Motor Stalled
Cause:	The motor is not turning at the expected rate.
Resolution:	Connect the AC adaptor or replace the batteries and resume the infusion.
LCD Display:	***ALARM *** INVALID UNITS FOR PUMP CONFIGURATION
Alarm:	Invalid Units for Pump Configuration.

Cause: The Library Protocol units are not valid for the pump configuration.
Resolution: Select a different Library Protocol or revise the Library Protocol.

LCD Display: ***ALARM *** INVALID ROUTE FOR PUMP CONFIGURATION
Alarm: Invalid Route for Pump Configuration
Cause: The Library Protocol Route is not valid for the pump configuration
Resolution: Select a different Library Protocol or revise the Library Protocol.

LCD Display: ***ALARM *** SYSTEM TIMEOUT
Alarm: System Timeout
Cause: Empty lithium battery
Resolution: Send pump to Moog or licensed service provider.

ERROR CODES

If a pump goes into an error code, a numeric code will appear on the display screen. If this has occurred, turn the pump off and back on. If the error code message does not reappear, continue using the pump.

If the pump passes its start-up diagnostic tests, resume the therapy. If an error code recurs, turn the pump off, replace it, and report the error code to the healthcare provider.

Error Code	LCD Displayed Message	Probable Cause	Corrective Action
10	Turn pump OFF/ON or Replace Battery or Call Provider	Motor Control Loss	<ul style="list-style-type: none"> • Replace Batteries • Connect AC Adaptor • Turn power off/on and resume
11	Turn pump Off/On	Keyboard Buffer Full	Report Error Code to Factory
12	Air Sensor Turn Pump Off/ON or Call Provider	Air In Line test circuit failure	Report Error Code to Factory
13	Pressure Sens DN Check Admin Set Turn pump Off/On	Bad Down Strain Beam	Replace set and Resume
14	Pressure Sens UP Check Admin Set Turn pump Off/On	Bad Up Strain Beam	Replace set and Resume
15	Turn Pump Off/On or Call Provider	Bad Encoder	Report Error Code to Factory
16	Turn pump Off/On or Call Provider	Bad Analog to Digital Conversion	Report Error Code to Factory
17	Turn pump OFF Call Provider	Bad Clock	Report error code to factory
18	Call Provider	Bad Air In Line comparator register reading from FPGA.	Report Error Code to Factory
19	Turn Pump OFF Call Provider	Bad Door Sensor	Report Error Code to Factory
20	Empty Lithium Battery Call Provider	Empty Lithium Battery	Report error code to factory
21	Turn Pump OFF Call Provider	Bad Tristate Pin	Report Error Code to Factory
22	Turn Pump OFF Call Provider	Bad Test Pin	Report Error Code to Factory
23	Turn Pump OFF Call Provider	Bad Reverence Voltage	Report Error Code to Factory
24	Turn Pump OFF Call Provider	Bad Motor Supply	Turn power OFF/ON and resume
25	Stalled Pump Turn Pump OFF/ON Call Provider	Broken Motor Shaft	Report Error Code to Factory
26	Turn Pump OFF Call Provider	Bad Motor Inhibit	Report Error Code to Factory
27	Turn Pump OFF Call Provider	Bad Motor Supply Enable	Connect Pump to AC Battery
28	Low Alarm Batt Connect AC Adapt Turn pump OFF/ON	Low Auxiliary Battery	Eliminator and Turn Power OFF/ON to Pump. May Require Turning Pump OFF/ON a Few Times
29			
30	Turn Pump OFF Call Provider	Bad Auxiliary Battery	Report Error Code to Factory
31	Turn Pump OFF Call Provider	Audio Main Speaker Low	Report Error Code to Factory
32	Turn Pump OFF Call Provider	Audio Main Speaker High	Check/replace D31. Replace PCB
33	Low Alarm Audio Connect AC Adapt Turn pump OFF/ON	Audio Auxiliary Speaker Low	Connect Pump to AC Battery Eliminator and Turn power OFF/ON to Pump. May Require Turning Pump OFF/ON a Few Times.
34	Turn Pump OFF Call Provider	Audio Auxiliary Speaker High	Report Error Code to Factory

Error Code	LCD Displayed Message	Probable Cause	Corrective Action
35	History File Turn pump OFF/ON	History Log Erased	Report Error Code To Factory
36	Bad Cal Data Turn pump OFF Call Provider	Bad EEPROM Data CRC value	Report Error Code To Factory
37	Turn Pump OFF Call Provider	Analog to Digital Converter did not Run	Report Error Code To Factory
38	Turn Pump OFF Call Provider	Air In Line Circuit not Tested	Report Error Code To Factory
39	Turn Pump OFF Call Provider	Bad EEPROM Data CRC 2	Report Error Code To Factory
40	Turn Pump OFF Call Provider	Bad EEPROM Data Header	Report Error Code To Factory
41	Bad Cal Range Turn Pump OFF Call Provider	Bad EEPROM Limit	Report Error Code To Factory
42	CRC Mismatch Turn Pump OFF Call Provider	Bad EPDATA	Report Error Code To Factory
45	Turn Pump OFF/ON Call Provider	Motor Control Loss	Report Error Code To Factory
46	Turn Pump OFF/ON Call Provider	Motor Control Loss	Report Error Code To Factory
76	Turn Pump OFF/ON Call Provider	Battery Task Timeout	Report Error Code To Factory
100	Turn Pump OFF/ON Call Provider	Menu Not Found	Report Error Code To Factory
101	Turn Pump OFF/ON Call Provider	Mode Not Found	Report Error Code To Factory
102	Turn Pump OFF/ON Call Provider	Item Not Found	Report Error Code To Factory
103	Turn Pump OFF/ON Call Provider	Field Not Found	Report Error Code To Factory
104	Turn Pump OFF/ON Call Provider	Data Mismatch	Report Error Code To Factory
105	Turn Pump OFF/ON Call Provider	No Menu Pointer	Report Error Code To Factory
106	Turn Pump OFF/ON Call Provider	Count Out Of Range	Report Error Code To Factory
107	Turn Pump OFF/ON Call Provider	Display Task Queue Overflow	Report Error Code To Factory
108	Turn Pump OFF/ON Call Provider	Divide By Zero	Report Error Code To Factory
109	Turn Pump OFF/ON Call Provider	Concentration Zero Value	Report Error Code To Factory
110	Turn Pump OFF/ON Call Provider	Invalid Occurrence	Report Error Code To Factory
111	Turn Pump OFF/ON Call Provider	Multiple Param Struct Access	Report Error Code To Factory
112	Turn Pump OFF/ON Call Provider	Multiple Status Struct Access	Report Error Code To Factory
140	Turn Pump OFF/ON Call Provider	Infusion Volume Out Of Range	Report Error Code To Factory
141	Turn Pump OFF/ON Call Provider	Infusion Rate Out Of Range	Report Error Code To Factory
142	Turn Pump OFF/ON Call Provider	Infusion Time Out Of Range	Report Error Code To Factory
143	Turn Pump OFF/ON Call Provider	Volume Conversion Error	Report Error Code To Factory
144	Turn Pump OFF/ON Call Provider	Rate Conversion Error	Report Error Code To Factory
145	Turn Pump OFF/ON Call Provider	Time Conversion Error	Report Error Code To Factory
146	Turn Pump OFF/ON Call Provider	Bad PCA Dose Ratio	Report Error Code To Factory

Error Code	LCD Displayed Message	Probable Cause	Corrective Action
160	Stuck PERIOD Key Turn Pump OFF/ON or Call Provider	Stuck Period / Silence Key	If Key Was Pressed, Release It. Otherwise Report Error Code To Factory.
161	Stuck ON OFF Key Turn Pump OFF/ON or Call Provider	Stuck ON / OFF Key	If Key Was Pressed, Release It. Otherwise Report Error Code To Factory.
162	Stuck 0 Key Turn Pump OFF/ON or Call Provider	Stuck 0 Key	If Key Was Pressed, Release It Otherwise Report Error Code to Factory
163	Stuck 1 Key Turn Pump OFF/ON or Call Provider	Stuck 1 Key	If Key Was Pressed, Release it Otherwise Report Error Code To Factory
164	Stuck 2 Key Turn Pump OFF/ON or Call Provider	Stuck 2 Key	If Key Was Pressed, Release It Otherwise Report Error Code To Factory
165	Stuck 3 Key Turn Pump OFF/ON or Call Provider	Stuck 3 Key	If Key Was Pressed, Release It Otherwise Report Error Code To Factory
166	Stuck 4 Key Turn Pump OFF/ON or Call Provider	Stuck 4 Key	If Key Was Pressed, Release It Otherwise Report Error Code To Factory
167	Stuck 5 Key Turn Pump OFF/ON or Call Provider	Stuck 5 Key	If Key Was Pressed, Release It Otherwise Report Error Code To Factory
168	Stuck 6 Key Turn Pump OFF/ON or Call Provider	Stuck 6 Key	Otherwise Report Error Code To Factory
169	Stuck 7 Key Turn Pump OFF/ON or Call Provider	Stuck 7 Key	If Key Was Pressed, Release It Otherwise Report Error Code To Factory
170	Stuck 8 Key Turn Pump OFF/ON or Call Provider	Stuck 8 Key	If Key Was Pressed, Release It Otherwise Report Error Code To Factory
171	Stuck 9 Key Turn Pump OFF/ON or Call Provider	Stuck 9 Key	If Key Was Pressed, Release It Otherwise Report Error Code To Factory
172	Stuck UP Key Turn Pump OFF/ON or Call Provider	Stuck Up Arrow Key	If Key Was Pressed, Release It Otherwise Report Error Code To Factory
173	Stuck NO Key Turn Pump OFF/ON or Call Provider	Stuck No / Change Key	If Key Was Pressed, Release It Otherwise Report Error Code To Factory
174	Stuck YES Key Turn Pump OFF/ON or Call Provider	Stuck Yes / Enter Key	If Key Was Pressed, Release It Otherwise Report Error Code To Factory
175	Stuck DOWN Key Turn Pump OFF/ON or Call Provider	Stuck Down Arrow Key	If Key Was Pressed, Release It Otherwise Report Error Code To Factory
176	Stuck RUN Key Turn Pump OFF/ON or Call Provider	Stuck Run / Pause Key	If Key Was Pressed, Release It Otherwise Report Error Code To Factory
177	Stuck HELP Key Turn Pump OFF/ON or Call Provider	Stuck Help / Options Key	If Key Was Pressed, Release It Otherwise Report Error Code To Factory
178	Stuck PRIME Key Turn Pump OFF/ON or Call Provider	Stuck Prime / Bolus Key	If Key Was Pressed, Release It Otherwise Report Error Code To Factory
179	Bolus Cord Unplug Cord Turn Pump OFF/ON	Stuck Remote Bolus Switch	If Bolus Switch was pressed, release it. Replace Bolus assembly. Otherwise report error code to factory
182	Turn Pump OFF/ON Call Provider	Invalid Key	Report Error Code To Factory
200	Turn Pump OFF/ON Call Provider	Invalid System State	Report Error Code To Factory
201	Turn Pump OFF/ON Call Provider	Bad Power Up Test Number	Report Error Code To Factory

Error Code	LCD Displayed Message	Probable Cause	Corrective Action
202	Turn pump OFF/ON Call Provider	Bad power up state	Report Error Code To Factory
203	Turn pump OFF/ON Call Provider	Bad A to D Max address	Report Error Code To Factory
204	Turn pump OFF/ON Call Provider	Bad run state	Report Error Code To Factory
205	Turn pump OFF/ON Call Provider	Bad pump status	Report Error Code To Factory
206	Turn Pump OFF/ON Call Provider	Bad Volume Type	Report Error Code To Factory
207	Turn Pump OFF/ON Call Provider	Bad Rate Type	Report Error Code To Factory
208	Turn Pump OFF/ON Call Provider	Bad Motor Test Number	Report Error Code To Factory
209	Turn Pump OFF/ON Call Provider	Bad Hist Type	Report Error Code To Factory
210	Turn Pump OFF/ON Call Provider	Bad EEPROM Data ID	Report Error Code To Factory
211	Turn Pump OFF/ON Call Provider	Bad Run Time CRC State	Report Error Code To Factory
212	Turn Pump OFF Call Provider	Bad EEPROM Write	Report Error Code To Factory
213	Turn Pump OFF Call Provider	Bad Total Volume	Report Error Code To Factory
214	Turn Pump OFF Call Provider	Bad Total Time	Report Error Code To Factory
215	Turn Pump OFF Call Provider	Bad Time Type	Report Error Code To Factory
216	Turn Pump OFF Call Provider	Bad Audio Level	Report Error Code To Factory
217	Turn Pump OFF Call Provider	Bad Menu CRC	Report Error Code To Factory
300	Turn Pump OFF Call Provider	Stack Overflow	Report Error Code To Factory
301	Turn Pump OFF Call Provider	Bad Flash	Report Error Code To Factory
302	Turn Pump OFF Call Provider	Bad Run Time Flash	Report Error Code To Factory
303	Turn Pump OFF Call Provider	Bad Ram	Report Error Code To Factory
304	Turn Pump OFF Call Provider	Bad Output Data	Report Error Code To Factory
305	Turn Pump OFF Call Provider	Bad Active Data	Report Error Code To Factory
306	Turn Pump OFF Call Provider	Bad Overflow Count	Report Error Code To Factory
307	Turn Pump OFF Call Provider	Therapy Data CRC Failure	Report Error Code To Factory
308	Watch Dog Call Provider	Bad Watch Dog Test	Report Error Code To Factory
309	Turn Pump OFF Call Provider	Stopped Motor Motion Count	Report Error Code To Factory
310	Turn Pump OFF Call Provider	Stopped Motor Motion Volt	Report Error Code To Factory
311	Turn Pump OFF Call Provider	Bad Active Flags	Report Error Code To Factory
312	Turn Pump OFF Call Provider	Bad Active Flags 2	Report Error Code To Factory
313	Turn Pump OFF Call Provider	Negative Motor Motion	Report Error Code To Factory
314	Turn Pump OFF Call Provider	Therapy Params Write Violate	Report Error Code To Factory
315	Turn Pump OFF Call Provider	Therapy Status Write Violate	Report Error Code To Factory
316	Turn Pump OFF/ON Call Provider	Configuration Settings May Have Been Compromised	Try To Turn Off Pump Then On. If Ok, Continue, If Error Recurs, Return For Service

Error Code	LCD Displayed Message	Probable Cause	Corrective Action
317	Turn Pump OFF/ON Call Provider	Configuration Settings May Have Been Compromised	Try To Turn Off Pump Then On. If Ok, Continue, If Error Recurs, Return For Service
320	Turn Pump OFF/ON Call Provider	Display String Oversize	Try To Turn Off Pump Then On. If Ok, Continue, If Error Recurs, Return For Service
321	Turn Pump OFF/ON Call Provider	Critical Data Failure	Try To Turn Off Pump Then On. If Ok, Continue, If Error Recurs, Return For Service
322	Turn Pump OFF/ON Call Provider	Task Execution Overrun	Try To Turn Off Pump Then On. If Ok, Continue, If Error Recurs, Return For Service
323	Turn Pump OFF/ON Call Provider	Interrupt Depth Overflow	Try To Turn Off Pump Then On. If Ok, Continue, If Error Recurs, Return For Service
324	Turn Pump OFF/ON Call Provider	Invalid Malfunction Code	Try To Turn Off Pump Then On. If Ok, Continue, If Error Recurs, Return For Service

Accessories

*There are a number of helpful accessories for use with the **Moog Curlin Infusion** pumps. Some of the most common accessories are described in this chapter. For a complete and updated list, refer to the Moog website. www.moog.com/medical.*

Detachable Pole Clamps

The pole clamps attach to the Lockable Safety Shells or the Pump Holster and can accommodate a pole of .75 to 1.25-inch diameter. There is a **Standard Pole Clamp (340-0104)** as well as a **Lockable Pole Clamp (340-0125)** available.

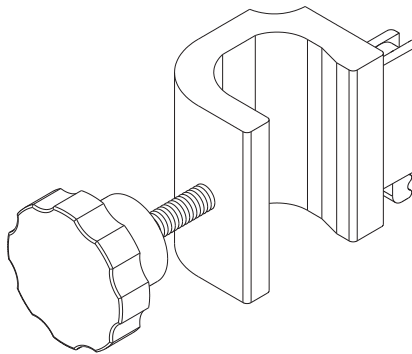

Figure 8.1 Detachable Pole Clamp

Lockable Safety Shells

These accessories are hard-plastic, durable cases that are **lockable with a key**. The **250 mL safety shell (360-0018)** will secure medication bags of up to 250 mL, administration set and the pump, and yet allow access to the pump's keypad, controls, communication connectors, and battery compartment door.

The 250 mL **safety shell** will also secure syringes and is available in light blue.

All security shells can be pole-mounted with the detachable pole clamp, set on a stable flat surface, or carried in a soft carry pack.

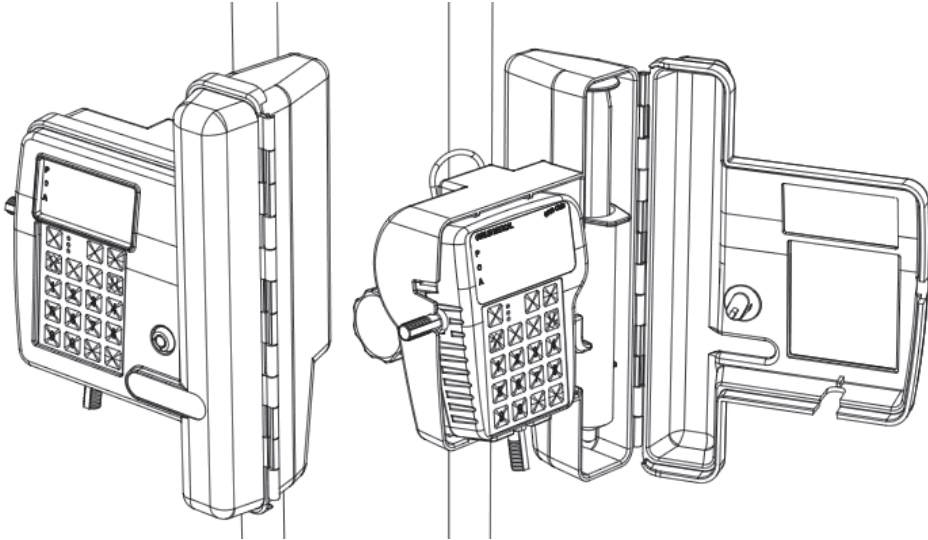

Figure 8.3 Safety Shells

Additional graphics below show how to install the Pole Clamp on the Lock Box.

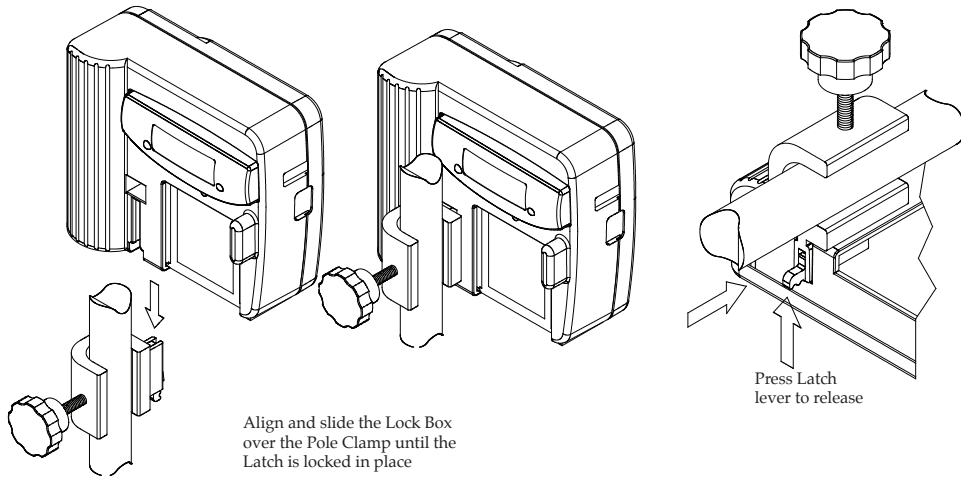

Figure 8.4 Pole Clamp and Safety Shell Installation

Pump Holster (340-0111)

This accessory is a simple “slide pump in” case with a pole clamp-mounting bracket on the back, allowing the pump to securely be mounted onto a pole and yet allow the user easy access to the display, keypad, controls, battery compartment, and connectors for external power or communications.

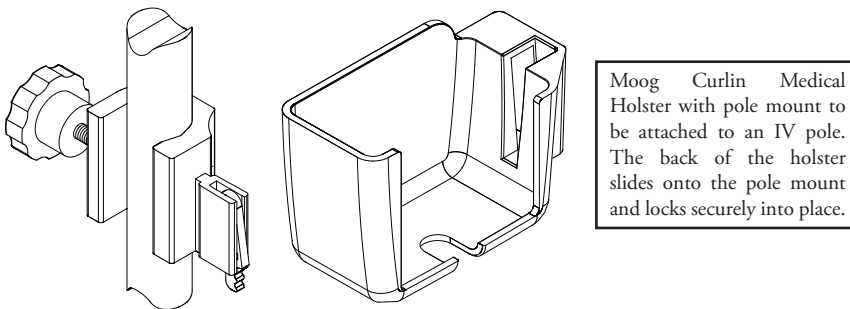

Figure 8.5 Pump “Holster”

Keypad Covers

These accessories are hard-plastic, durable keypad covers that can optionally be used with the (340-0141, 340-0141-01 and 340-0141-02) lockboxes to cover the keypad. The keypad covers are available in four configurations:

- **Type 0 (340-0142)** covers all the keys.
- **Type I (340-0142-01)** covers all the keys, with the exception of the SILENCE and RUN/PAUSE keys.
- **Type II (340-0142-02)** covers only the numerical and PRIME/BOLUS keys.
- **Type III (340-0142-03)** covers all the keys, with the exception of the SILENCE key.

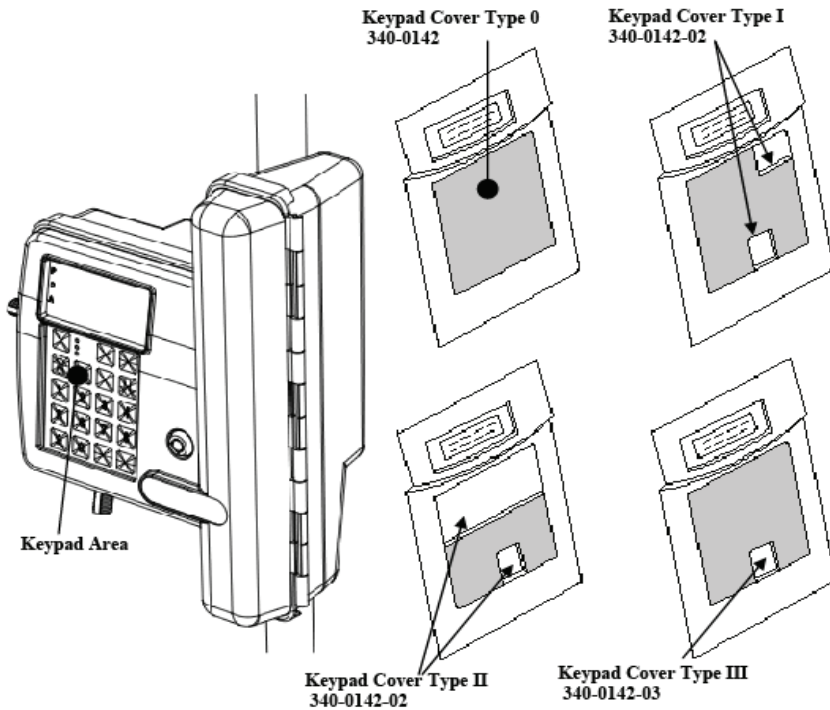

Figure 8.6 Keypad Covers

Cleaning, Environmental Conditions, and Maintenance

*Following the guidelines for care listed below will assure the best appearance and longest life of the **Moog Curlin Infusion** pump.*

Cleaning

The **Moog Curlin Infusion** pumps are designed to be resistant to fluid spillage from any direction but are *not* to be immersed in solutions. Keep the pump and the pumping surfaces clean, dry, and free of fluid spillage at all times. Do not use the pump in the shower, sauna, or steam bath and do not position the pump where it could accidentally be dropped into a container of fluid, (e.g. basin, tub, or toilet). The pumping surfaces can be cleaned with a cloth dampened with any of the following solutions, and dried with a soft cloth without harming the pump.

Clean the pump, remote bolus cord, AC adaptor, safety shells, holster and battery pack with a soft cloth dampened in any of the following:

- Warm soapy water (do not submerge)
- Isopropyl alcohol
- Household bleach, diluted 9:1 with water
- Commercial disinfectant

(Do NOT spray the cleaning solution directly on the pump.)

IMPORTANT INFORMATION

The following cleaning/disinfecting methods are specifically prohibited:

- Do not use full strength bleach
- Do not autoclave or use steam sterilization
- Do not clean in a dishwasher
- Do not use acetone, lacquer thinner, or any other solvents or abrasive cleansers to clean the pump

With proper care, the pump will retain its finish for many years of service.

Transport and Storage

During transport or storage, the batteries should be removed; the pump should be cleaned and kept in its hard-shell packing case. The environmental conditions should be within the range of:

- An ambient temperature -20° F to 140°F
- A relative humidity range of 5% to 95%; 375 mmhg to 795 mmhg
- An atmospheric pressure range of 500 Hpa to 1060 Hpa

All accessories should be stored in their original packing containers to ensure the longest service.

Operating Environment

The following conditions of ambient temperature range and relative humidity are recommended for the fluid delivered accuracy of:

- Temperature: ±5% Accuracy: 55 to 90°F
 ±10% Accuracy: 45 to 55°F
 ±10% Accuracy: 90 to 104°F
- Relative Humidity: 15 to 95% Non-condensing

Maintenance

Yearly preventive maintenance checks are recommended and will be prompted in the Set-Up Menu and on the display when the date occurs. This date accrues from the date of factory release and is reset when each annual maintenance check is completed.

Any time an error code message occurs repeatedly or any time a pump appears to be tampered with or shows any indication of not performing to standards, the pump should be returned to the healthcare provider dispensing the pump.

At no time should unauthorized personnel open the hard case of the pump.

Limited Warranty

ZEVEX, Inc. (the Manufacturer) warrants to the original purchaser that the infusion pump (the Pump), not including accessories, shall be free from defects in material and workmanship under normal use, if used in accordance with this User's Manual, for a period of one year from the actual date of sale to the original purchaser. THERE ARE NO OTHER WARRANTIES.

The warranty does not cover normal wear and tear and maintenance items, and specifically excludes batteries, administration sets, extension sets or any other accessory items or equipment used with the pump.

Subject to the conditions of and upon compliance with this limited warranty, the manufacturer will repair or replace at its option without charge (except for a minimal charge for postage and handling) any pump (not including accessories) which is defective if a claim is made during such one year period.

The following conditions, procedures, and limitations apply to the manufacturer's obligation under this warranty:

1. **PARTIES COVERED BY THIS WARRANTY:** This warranty extends only to the original Purchaser of the pump. This warranty does not extend to subsequent purchasers. The original Purchaser may be a patient, medical personnel, or a medical facility that purchases the pump for treatment of patients. The original purchaser should retain the invoice or sales receipt as proof as to the actual date of purchase.
2. **WARRANTY PERFORMANCE PROCEDURE:** Notice of the claimed defect must be made in writing or by telephone to the Manufacturer as follows: **Customer Service Department, ZEVEEX, Inc., 4314 ZEVEEX Park Lane, Salt Lake City, UT 84123, (801) 264-1001.** Notice to the manufacturer must include date of purchase, model and serial number, and a description of the claimed defect in sufficient detail to allow the manufacturer to determine and facilitate any repairs that may be necessary. **AUTHORIZATION MUST BE OBTAINED PRIOR TO RETURNING THE PUMP,** and confirmed with issuance of an RMA (Return Materials Authorization) number. When authorized, the pump must be properly and carefully packaged and returned to the manufacturer, postage prepaid. Any loss or damage during shipment is at the risk of the sender.
3. **CONDITIONS OF WARRANTY:** The warranty is void if the pump has been 1) repaired by someone other than the manufacturer or its authorized agent; 2) altered so that its stability or reliability is affected; 3) misused; or, 4) damaged by negligence or accident. Misuse includes, but not limited to, use not in compliance with the User's Manual or use with non approved accessories. The pump is a sealed unit, and the fact that the seal has been broken will be considered conclusive evidence that the pump has been altered or misused. Removal or damage to the pump's serial number will invalidate this warranty.
4. **LIMITATIONS AND EXCLUSIONS:** Repair or replacement of the pump or any component part thereof is the **EXCLUSIVE** remedy offered by the manufacturer. The following and limitations shall apply:
 - a. No agent, representative, or employee of the manufacturer has authority to bind the manufacturer to any representation or warranty, expressed or implied.
 - b. **THERE IS NO WARRANTY OF MERCHANTABILITY OR FITNESS OR USE OF THE PUMP FOR ANY PARTICULAR PURPOSE.**
 - c. The pump can only be used under the supervision of medical personnel whose skill and judgment determine the suitability of the pump for any particular medical treatment.
 - d. All recommendations, information, and descriptive literature supplied by the Manufacturer or its agents are believed to be accurate and reliable, but do not constitute warranties.

The manufacturer disclaims responsibility for the suitability of the pump for any particular medical treatment or for any medical complications resulting from the use of the pump. The manufacturer shall not be responsible for any incidental damages or consequential damages to property, loss of profits, or loss of use caused by any defect or malfunction of the pump.

This warranty gives the original purchaser specific legal rights, and the original purchaser may have other legal rights, which may vary from state to state.

Procedure for Checking Pumps Between Patients

Purpose

This procedure is provided for use by caregivers to ensure pumps meet all critical performance specifications prior to use of the product on new patients. This procedure is for use by technicians to inspect, test, and prepare a pump for use by a new patient. The test checks for volumetric accuracy and all pump safety systems. Also, various parameters are initialized.

Note: Between patient testing is not required for Moog Curlin Infusion pumps when anti-siphon valve administration sets are being used.

This procedure is intended to be used by technicians familiar with operation of the Moog Curlin PainSmart™ IOD infusion pump.

Note: This procedure does not replace the recommended annual preventive maintenance. The pump should receive preventive maintenance by a qualified technician at least annually.

Outpatient/Home Care/ Alternate Care Site Environment

If the pump is used in an outpatient, home care, or alternate care setting, the pump must be checked between patients using the following procedure.

Inpatient/Hospital Environment

Moog Medical offers delivery sets with an anti-siphon valve for use in clinical situations where in between patient checks may not be practical.

Note: Between patient testing is not required for Moog Curlin Infusion pumps when *integral* anti-siphon valve administration sets are being used.

Moog Medical highly recommends that the hospital conduct in between patient checks using the following procedure **if integral anti-siphon valve administration sets are not being used**. Should the hospital determine, for whatever reason, that the in between patient check is not practical, Moog Medical recommends performing volumetric accuracy checks at regular intervals, to ensure the pump continues to meet specifications.

Required Equipment

The following equipment is required for this procedure:

- A NEW Administration Set (old or used sets are not suitable for the volumetric delivery and pressure measurements tests).
- Volumetric measurement device (i.e. calibrated weight scale, burette or syringes).

- Beaker with clean, fresh water or IV container.

Note: If the administration set contains a filter, sterile saline or sterile water should be used.

Maintenance between Patients

1. CLEAN AND INSPECT PUMP FOR DAMAGE:

- Clean the pump with a soft cloth dampened with a designated antiseptic, disinfectant solution or a solution of household bleach diluted 9:1 with water. Be sure to clean all surfaces, including the pumping chamber.
- Inspect pump for damage. Check all case surfaces for cracks. Open the pumping chamber door. Examine the finger seal to confirm that no cuts or tears exist. Confirm that the door is well aligned by closing it with no unreasonable interference. Verify that the power and bolus/data connectors are securely mounted on the case (no loose nuts). Verify that all labels are legible and in good condition. Check that keypad is securely attached to case and that no corners are peeling up. Verify that the battery door is in place and that the battery contacts in the battery compartment are not deformed.

Refer to the picture below when executing the following instructions.



2. Volumetric Delivery Test:

- Install a new primed Administration Set in the pump and latch the door.
- Connect the up-stream side of administration set to a water source 12 inches +/- 2

inches above the pump.

- c. Connect the downstream side of the administration set to a volumetric accuracy measurement device (i.e. a calibrated scale or burette) at the same level as the pump +/- 2 inches.

EPI		IV	
Pre Rx:		Pre Rx:	
UNITS:	mL	UNITS:	mg
Admin Rt:	EPI	CONC:	1 mg/mL
Load Dose:	0.0 mL	Admin Rt:	IV
MedLMTS™:	OFF	Load Dose:	OFF
NEXT?	YES	MedLMTS™:	OFF
		NEXT?	YES
Prescription:		Prescription:	
BAG VOL:	100 mL	BAG VOL:	100 mL
RATE:	0 mL/hr	RATE:	0 mg/mL
Pt Bolus:	9.9 mL	Pt Bolus:	9.9 mg 1
BOLS INT:	1 min	BOLS INT:	1 min
#BOLS/hr:	1	#BOLS/hr:	1
DONE?	YES	DONE?	YES

- d. Program one of the following Infusions based on the default in the pump:
 e. Start the pump by pressing RUN button.
 f. Press the BOLUS key to start a bolus.
 g. When the 9.9 mL infusion is over, observe the amount volume infused as measured on the measurement device. Passing measurement is: 9.4 g to 10.4 g (9.4 mL to 10.4 mL).
 h. When “INFUSION COMPLETE” displays verify that the audio alarm beeps and that the green LED is flashing.

3. CHECK ALL SAFETY SYSTEMS:

Repeat the same Rx as above. Start the infusion and press the BOLUS key to start a bolus dose.

- a. **Low Down Stream Occlusion** - Go to the Option screen and confirm that the Down Occlusion level is set to LOW. Start the infusion and while the pump is running pinch off or close the down stream side of the administration set. Confirm the pump goes into Down Occlusion alarm. Open or clear the down stream occlusion and confirm the pump resumes infusion.
- b. **High Down Stream Occlusion** - Go to the Option screen and change the Down Occlusion level to HIGH. Again pinch off or close the clamp on the down-stream side of the administration set. Confirm the pump goes into Down Occlusion. Open or clear the down stream occlusion and confirm the pump resumes infusion.

- c. **Up Stream Occlusion** - Resume the infusion pumping then pinch off or close the up-stream side of the administration set. Confirm that the pump goes into an Up Occlusion alarm. Open or clear the up stream occlusion, press PAUSE then RESUME the infusion.
 - d. **Door Sensor** - With infusion in progress open the door latch and observe “ALARM DOOR OPEN OR SET NOT PROPERLY INSTALLED.” Press PAUSE and then “YES to RESUME” on the Pause Menu.
 - e. **Set Sensor** - Remove the administration set from the pump and reinstall it so that the flow stop and tubing guide are not in the pumping chamber. Close the door latch and start an infusion by pressing the RUN key. Observe “***ALERT *** DOOR OPEN or SET NOT PROPERLY INSTALLED” will occur.
 - f. **Air In Line Sensor** - Reinstall the administration set properly and resume the infusion. From the Options menu set the AIL SENS (AIR IN LINE sensitivity) to 0.1mL. With the pump running introduce an Air Bolus of approximately 0.5mL into the fluid path at the input side of the pump. Once approximately 0.1mL of air has past the AIL detector, an “ALARM AIR IN LINE” will occur. Pause and prime the air bolus past the AIL sensor, then resume the infusion.
 - g. **Auxiliary Alarm** - With the pump running observe the Vol INF (volume infused on the run screen) and disconnect the pump from all power sources (unplug the AC Adaptor eliminator and remove one C-cell battery.) Observe that the Auxiliary Alarm System is activated, with the red LED and beeper on constant (not intermittently beeping). With the battery still out of the pump, press the ON/OFF button to turn off the auxiliary alarm. Replace the battery in the battery compartment and turn on the pump. Resume the therapy and confirm that the infusion continues where it stopped due to Auxiliary Alarm occurrence.
- 4 SET BioMed CLINICIAN MENU ITEMS:
- a. Turn the pump off and back on. While pump is performing self tests confirm that the pump is set to the correct date and time. If date and time are not correct, program the correct date and time from the BioMed/Clinician menu.

Note: Setting of the date and time is not allowed if “RESUME” (infusion is still active) is available on the Pause Menu. Use the “CLEAR Pt Data/Rx” option on the BioMed/Clinician menu to clear the prescriptions and end the infusion. The date and time can then be programmed.

- b. From the Program/BioMed Setup Menu select “BioMed Setup.”
- c. At the Enter Code Menu, enter the Clinician Code.
- d. (Optional) Erase the patient history file using the Clear Hx Log Menu.
- e. Erase any previous Programmer ID, Patient ID, Rx Number, Invoice Number, Lock Level setting, and prescriptions using the Clear Pt Data/Rx Menu.
- f. Observe the Pump Maintenance Date, top of the BioMed/Clinician Menu, to insure adequate time for the next use by patient.
- g. Sign, date and return the check list to your record file. Pumps that pass can be used for new patients. Pumps that fail are to be returned for service.

Technical Specifications

The following specifications apply to the **Moog Curlin Infusion** Ambulatory Infusion Pump:

Note: Flow rates and bolus dose limits may be less than indicated in these tables based on specific customizations.

ITEM	SPECIFICATION
Pumping Mechanism:	Curvilinear peristaltic finger action
Pump Size:	
Height:	5 inches
Width:	4 inches
Depth:	2.5 inches
Weight:	18.1 inches
Case Material:	UL rated flame-retardant, non-toxic high impact plastic
Operating Environment:	
Operating Temperature:	± 5% Accuracy: 55° to 90°F ±10% Accuracy: 45° to 55°F ±10% Accuracy: 90° to 104°F
Operating Relative Humidity:	15 to 95% non-condensing
Storage Environment:	
Storage Temperature Range:	-20° to 140°F
Storage Relative Humidity:	5% to 95%; 375 to 795 mmhg

Power Requirements	2 C-cell single-use batteries AC Power										
ITEM	SPECIFICATION										
Operating Time with Full Charge Batteries	Approximately 185 hours at a rate of 2 mL/hr										
Internal Memory Battery	5 years life										
Display	Graphic LCD, 4 text fields, 16 characters per field										
Flow Rates	0.1 to 50 mL/hr										
Bolus Rates	Up to 125 mL/hr										
Volume Accuracy	<p>± 5% for volume delivery >1 mL under the following conditions:</p> <ul style="list-style-type: none"> • Temperature 55° to 90° F • Back pressure to 300 mmHg (5.8 PSI) <p>±10% for volume delivery >1 mL under the following conditions:</p> <ul style="list-style-type: none"> • Temperature 45° to 55°F • Temperature 90° to 104°F • Back pressure to 750 mmHg (14.5 PSI) <p>The maximum volume that may be infused under Single Fault Conditions is 0.8 mL. Refer to administration set IFU for recommended time usage. *follow standards of practice for set changes</p>										
Administration Sets	Proprietary Moog Curlin Infusion non-DEHP, PVC administration sets available in different configurations.										
Fill Volume for Administration Sets	Non-filtered microbore sets ± 4 mL. See individual administration set label for specific fill volume										
Up Occlusion Detection Time Microbore tubing with occlusion below spike	<table> <thead> <tr> <th><u>Rate</u></th> <th><u>Time to Alarm</u></th> </tr> </thead> <tbody> <tr> <td>0.1 mL/hr</td> <td><25 minutes</td> </tr> <tr> <td>1 mL/hr</td> <td>< 4 minutes</td> </tr> <tr> <td>10 mL/hr</td> <td><20 seconds</td> </tr> <tr> <td>50 mL/hr</td> <td><10 seconds</td> </tr> </tbody> </table>	<u>Rate</u>	<u>Time to Alarm</u>	0.1 mL/hr	<25 minutes	1 mL/hr	< 4 minutes	10 mL/hr	<20 seconds	50 mL/hr	<10 seconds
<u>Rate</u>	<u>Time to Alarm</u>										
0.1 mL/hr	<25 minutes										
1 mL/hr	< 4 minutes										
10 mL/hr	<20 seconds										
50 mL/hr	<10 seconds										

Down Occlusion Detection Time Microbore tubing with occlusion at distal Luer	For non-filtered sets: <table border="1"> <thead> <tr> <th>Rate</th> <th>Low Pressure</th> <th>High Pressure</th> </tr> </thead> <tbody> <tr> <td>0.1 mL/hr</td> <td>≤ 1 hr. 30 minutes</td> <td>≤ 2 hrs. 15 minutes</td> </tr> <tr> <td>1 mL/hr</td> <td>≤ 7 minutes</td> <td>≤ 16 minutes</td> </tr> <tr> <td>10 mL/hr</td> <td>≤ 40 seconds</td> <td>≤ 1min. 30 seconds</td> </tr> <tr> <td>50 mL/hr</td> <td>≤ 6 seconds</td> <td>≤ 15 seconds</td> </tr> <tr> <td>125 mL/hr</td> <td>≤ 3 seconds</td> <td>≤ 5 seconds</td> </tr> </tbody> </table>	Rate	Low Pressure	High Pressure	0.1 mL/hr	≤ 1 hr. 30 minutes	≤ 2 hrs. 15 minutes	1 mL/hr	≤ 7 minutes	≤ 16 minutes	10 mL/hr	≤ 40 seconds	≤ 1min. 30 seconds	50 mL/hr	≤ 6 seconds	≤ 15 seconds	125 mL/hr	≤ 3 seconds	≤ 5 seconds
	Rate	Low Pressure	High Pressure																
0.1 mL/hr	≤ 1 hr. 30 minutes	≤ 2 hrs. 15 minutes																	
1 mL/hr	≤ 7 minutes	≤ 16 minutes																	
10 mL/hr	≤ 40 seconds	≤ 1min. 30 seconds																	
50 mL/hr	≤ 6 seconds	≤ 15 seconds																	
125 mL/hr	≤ 3 seconds	≤ 5 seconds																	
For filtered sets: <table border="1"> <thead> <tr> <th>Rate</th> <th>Low Pressure</th> <th>High Pressure</th> </tr> </thead> <tbody> <tr> <td>0.1 mL/hr</td> <td>≤ 9 hr. 15 minutes</td> <td>≤ 20 hrs.30 minutes</td> </tr> <tr> <td>1 mL/hr</td> <td>≤ 50 minutes</td> <td>≤ 2 hrs. 5 minutes</td> </tr> <tr> <td>10 mL/hr</td> <td>≤ 4 min. 30 seconds</td> <td>≤ 10 min. 30 seconds</td> </tr> <tr> <td>50 mL/hr</td> <td>≤ 50 seconds</td> <td>≤ 3 minutes</td> </tr> <tr> <td>125 mL/hr</td> <td>≤ 20 seconds</td> <td>≤ 50 seconds</td> </tr> </tbody> </table>	Rate	Low Pressure	High Pressure	0.1 mL/hr	≤ 9 hr. 15 minutes	≤ 20 hrs.30 minutes	1 mL/hr	≤ 50 minutes	≤ 2 hrs. 5 minutes	10 mL/hr	≤ 4 min. 30 seconds	≤ 10 min. 30 seconds	50 mL/hr	≤ 50 seconds	≤ 3 minutes	125 mL/hr	≤ 20 seconds	≤ 50 seconds	
Rate	Low Pressure	High Pressure																	
0.1 mL/hr	≤ 9 hr. 15 minutes	≤ 20 hrs.30 minutes																	
1 mL/hr	≤ 50 minutes	≤ 2 hrs. 5 minutes																	
10 mL/hr	≤ 4 min. 30 seconds	≤ 10 min. 30 seconds																	
50 mL/hr	≤ 50 seconds	≤ 3 minutes																	
125 mL/hr	≤ 20 seconds	≤ 50 seconds																	
ITEM	SPECIFICATION																		
Programmable Time (HH:MM) PCA	No time limit																		
Bolus Volumes Microbore tubing with occlusion at distal Luer	Low Pressure: <0.1 mL High Pressure: <0.1 mL																		

Guidance and manufacturer's declaration – electromagnetic emissions

The Curlin Infusion Pump is intended for use in the electromagnetic environment specified below. The customer or the user of the Curlin Infusion Pump should assure that it is used in such an environment.

Emission test	Compliance	Electromagnetic environment- guidance
RF emissions CISPR 11 EN 55011	Group 1	The Curlin Infusion Pump must emit electromagnetic energy in order to perform its intended function. Nearby electronic equipment may be affected.
RF emissions CISPR 11 EN 55011	Class B	The Curlin Infusion Pump is suitable for use in all establishments including domestic and those directly connected to the public low-voltage power supply network that supplies buildings used for domestic purposes.
Harmonic emissions IEC 61000-3-2	Class A	
Voltage fluctuations/ flicker emissions IEC 61000-3-3	Complies	

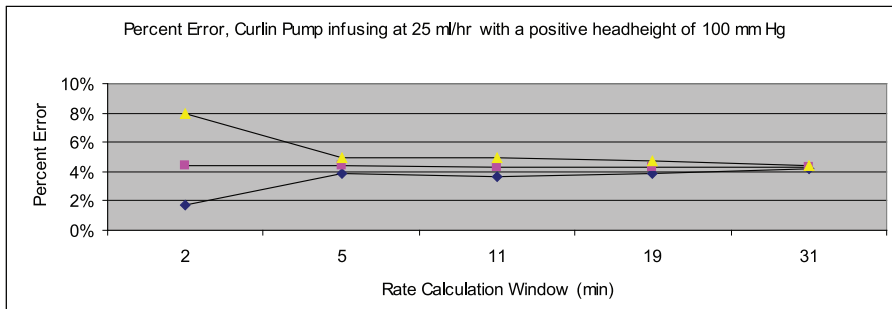
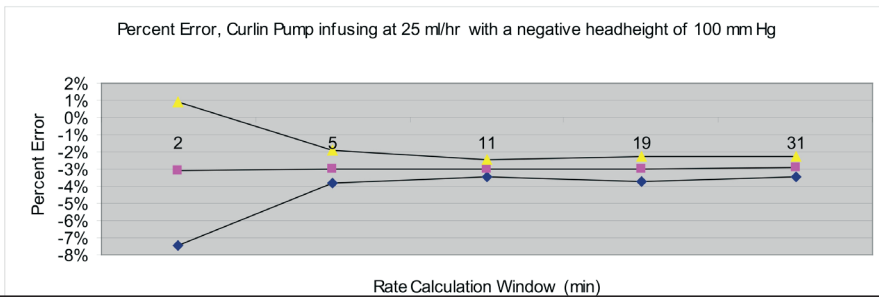

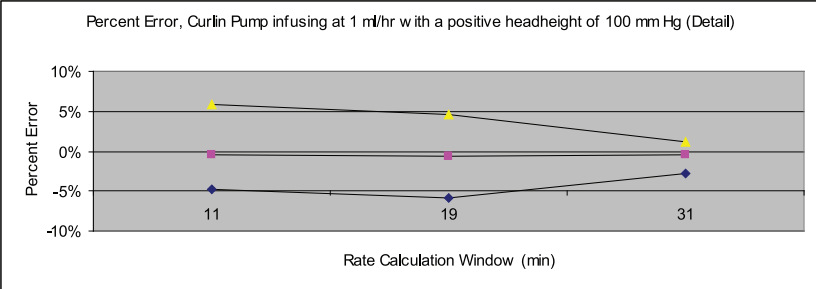
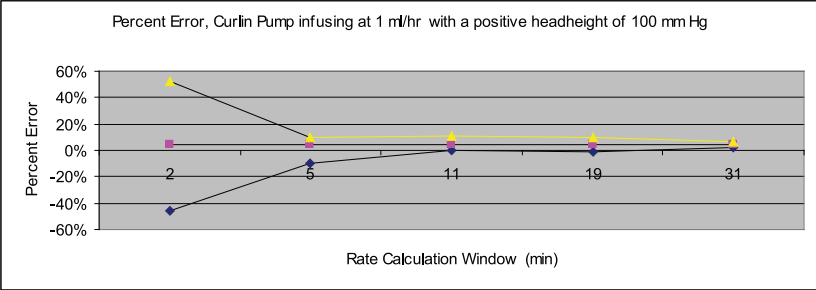
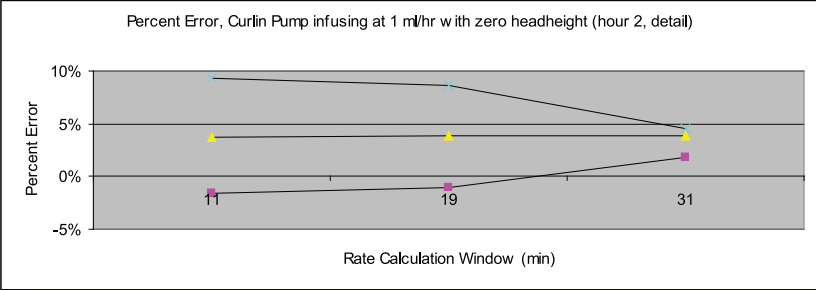
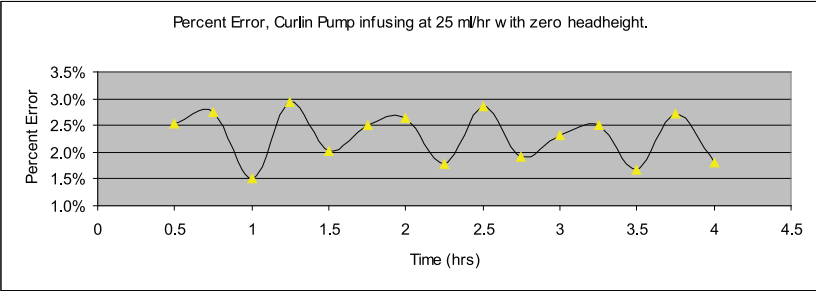

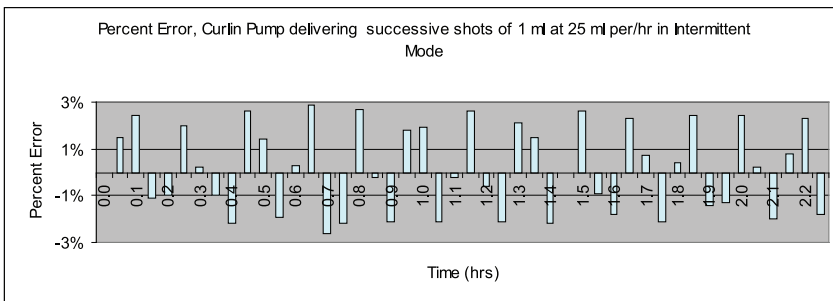
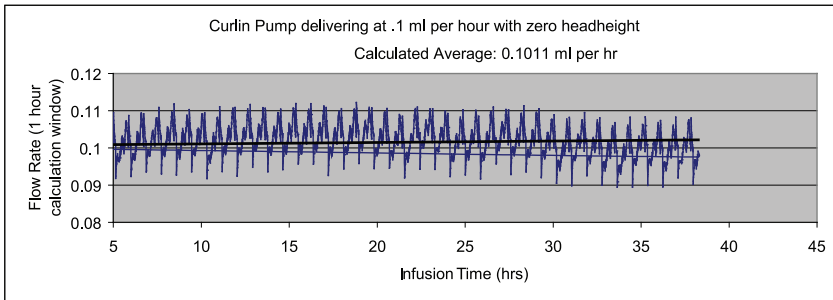
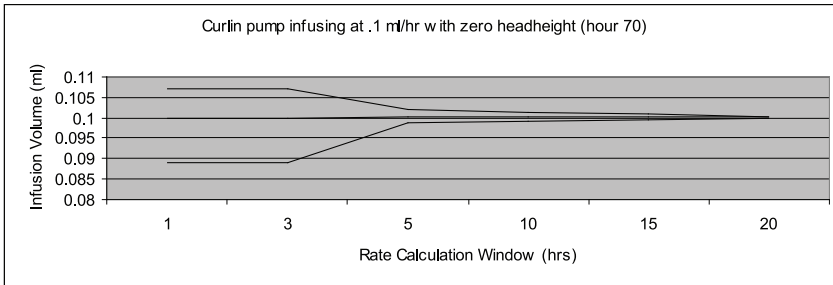
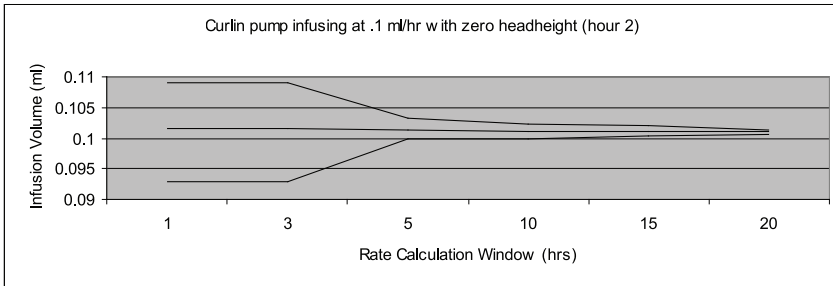

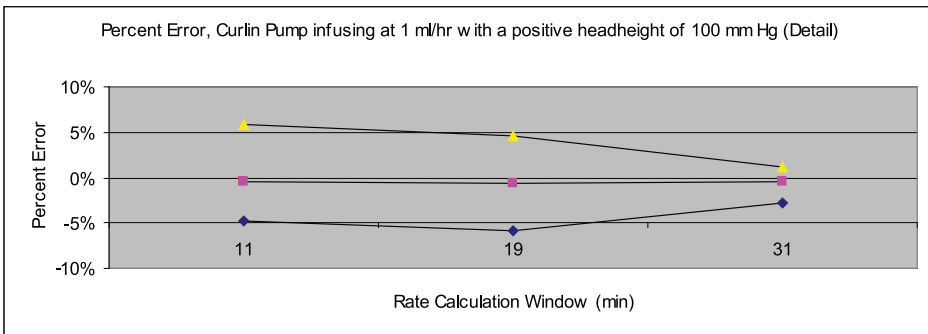
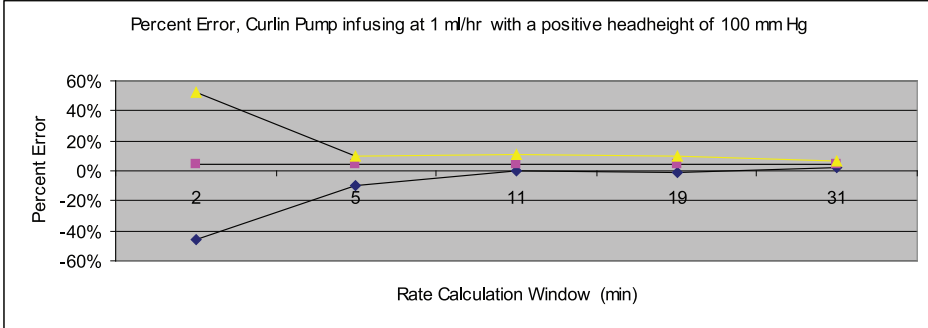
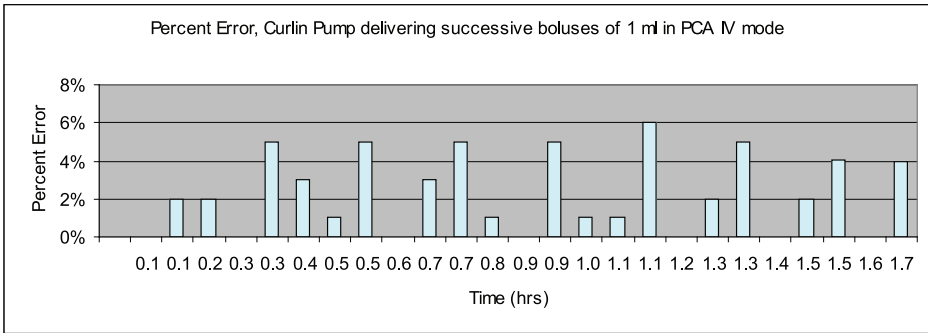
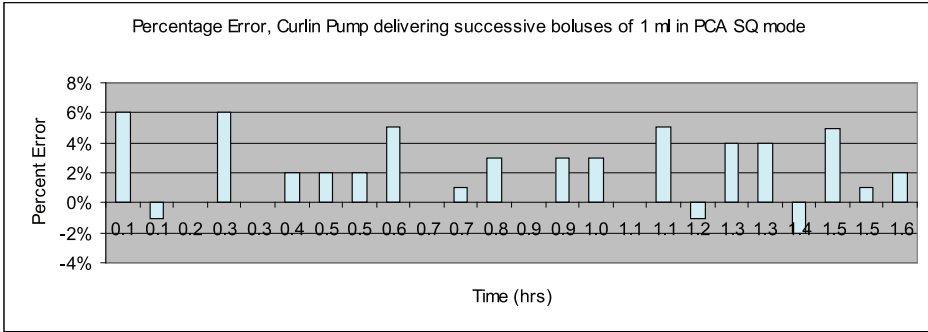

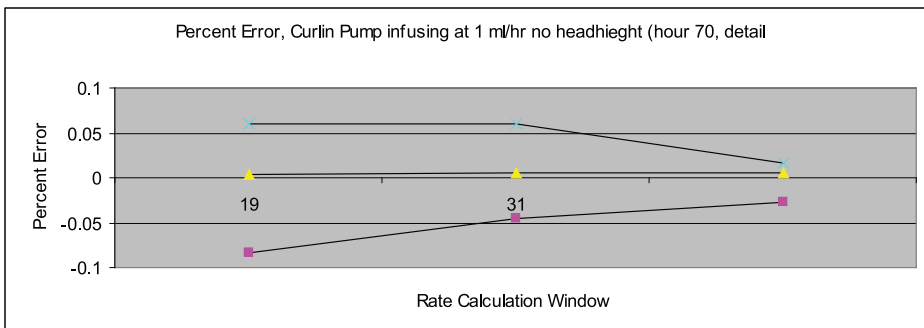
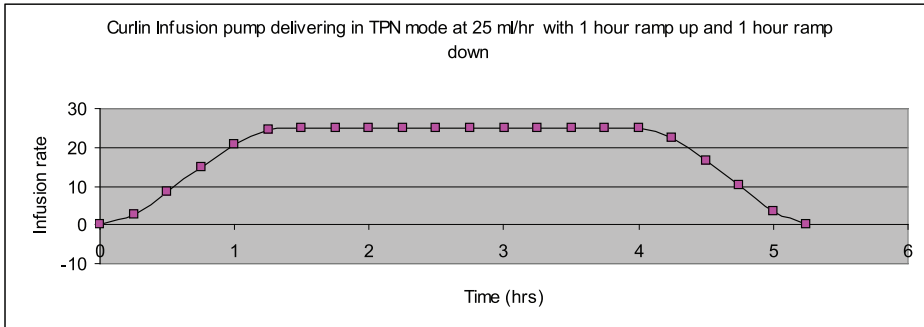
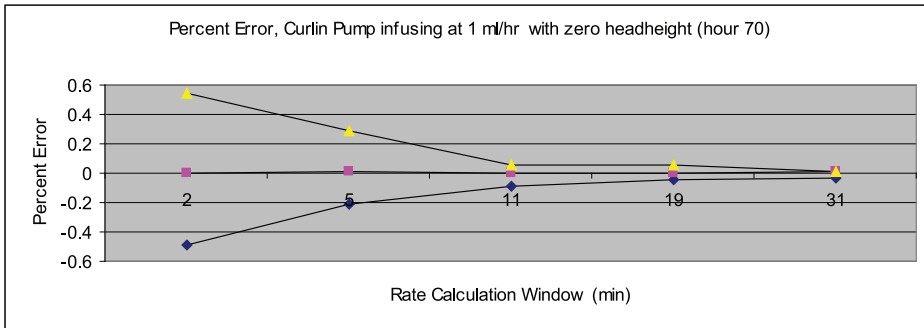
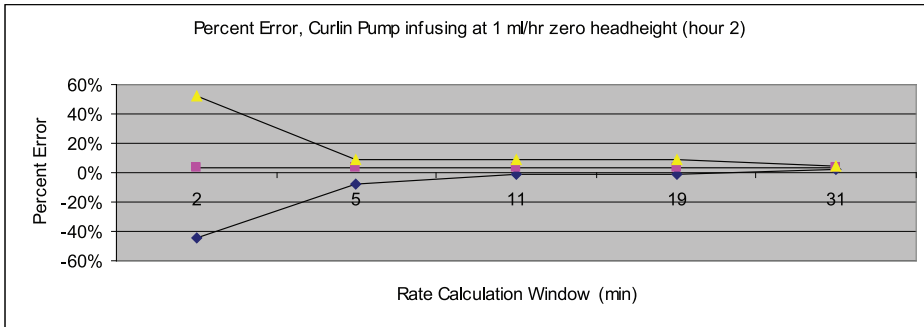

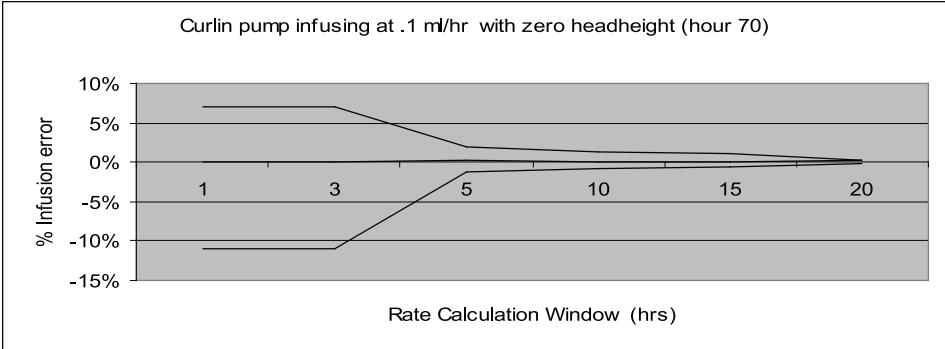
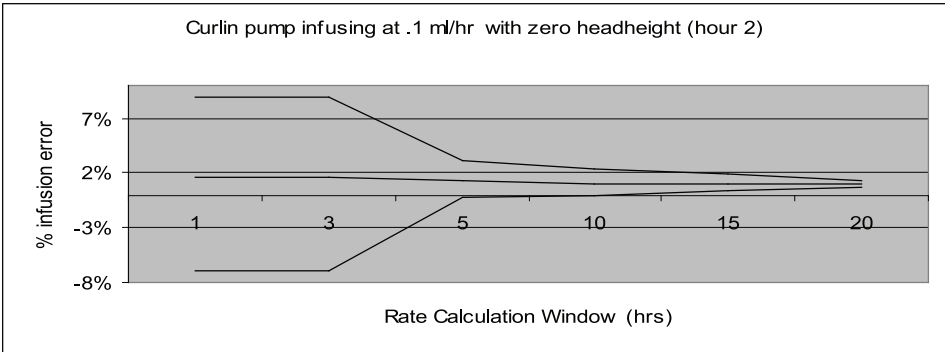
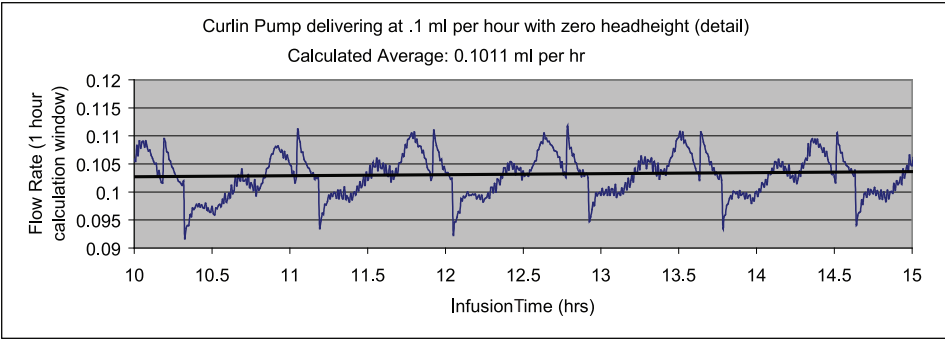



Guidance and manufacturer's declaration - electromagnetic immunity			
The PainSmart™ IOD, 6000 CMS™ and 6000 CMS™ IOD™ is intended for use in electromagnetic environment specified below. The customer or the user of the PainSmart™ IOD, 6000 CMS™ and 6000 CMS™ IOD™ should assure that it is used in such an environment.			
IMMUNITY test	IEC 60601 test level	Compliance level	Electromagnetic environment - guidance
Electrostatic Discharge (ESD) IEC 61000-4-2	2, 4, 6 kV contact 2, 4, 8 kV air	± 6 kV contact ± 8 kV air	Floors should be wood, concrete or ceramic tile. If floors are covered with synthetic material, the relative humidity should be at least 30%.
Electrical fast Transient / burst IEC 61000-4-4	± 2 kV AC mains ± 1 kV for signal or data	± 2 kV for power supply lines ± 1 kV for for input/output lines	Mains power quality should be that of a typical commercial or hospital environment.
Surge IEC 61000-4-5	Mains: ± 1 kV line(s) to line(s) ± 2 kV line(s) to earth Signal ports: 1 kV lines(s) to earth DC I/O ports: 0.5 kV line(s) to line(s) 0.5 kV line(s) to earth	1 kV line(s) to (lines) ± 2 kV line(s) to earth	Mains power quality should be that of a typical commercial or hospital environment.
Voltage dips, short Interruptions and voltage variations on power supply input lines IEC 61000-4-11	<5 % U _i (>95% dip in UT) for 0,5 cycle 40 % U _i (60 % dip in UT) for 5 cycles 70 % U _i (30 % dip in UT) for 25 cycles <5 % U _i (>95% dip in UT) for 5 s	<5 % U _i (>95% dip in UT) for 0,5 Cycle 40 % U _i (60% dip in UT) for 5 cycles 70 % U _i (30% dip in UT) for 25 cycles <5 % U _i (>95% dip in UT) for 5 s	Mains power quality should be that of a typical commercial or hospital environment. If the user of the PainSmart™ IOD, 6000 CMS™ and 6000 CMS™ IOD™ requires continued operation during power mains interruptions, it is recommended that the PainSmart™ IOD, 6000 CMS™ and 6000 CMS™ IOD™ be powered from an uninterruptible power supply or a battery.
Power frequency (50/60 Hz) Magnetic field IEC 61000-4-8	3 A/m	3 A/m	Power frequency magnetic fields should be at levels characteristic of a typical location in a typical commercial or hospital environment.
NOTE: U _i is the a.c. mains voltage prior to application of the test level.			

Recommended separation distances between portable and mobile RF communications equipment and the Painsmart™ IOD, 6000 CMS™ and 6000 CMS™ IOD™			
The Painsmart™ IOD, 6000 CMS™ and 6000 CMS™ IOD™ is intended for use in an electromagnetic environment in which radiated RF disturbances are controlled. The customer or the user of the Painsmart™ IOD, 6000 CMS™ and 6000 CMS™ IOD™ can help prevent electromagnetic interference by maintaining a minimum distance between portable and mobile RF communications equipment (transmitters) and the Painsmart™ IOD, 6000 CMS™ and 6000 CMS™ IOD™ as recommended below, according to the maximum output power of the communications equipment.			
Rated maximum output power of transmitter W	Separation distance according to frequency of transmitter		
	150 KHz to 80 MHz $d = \left[\frac{3,5}{V_1} \right] \sqrt{P}$	80 MHz to 800 MHz $d = \left[\frac{3,5}{E_1} \right] \sqrt{P}$	800 MHz to 2,5 GHz $d = \left[\frac{3,5}{E_1} \right] \sqrt{P}$
0.01	0.116	0.12	0.23
0.1	0.369	0.34	0.74
1	1.16	1.7	2.3
10	3.69	3.7	7.4
100	11.7	11.7	23.3
For transmitters rated at a maximum output power not listed above, the recommended separation distance d in meters (m) can be estimated using the equation applicable to the frequency of the transmitter, where p is the maximum output power rating of the transmitter in watts (W) according to the transmitter manufacturer. Note 1 At 80 MHz and 800 MHz, the separation distance for the higher frequency range applies. Note 2 These guidelines may not apply in all situations. Electromagnetic propagation is affected by absorption and reflection from structures, objects and people.			

Guidance and manufacturer's declaration - electromagnetic immunity			
The PainSmart™ IOD, 6000 CMS™ and 6000 CMS™ IOD™ is intended for use in electromagnetic environment specified below. The customer or the user of the PainSmart™ IOD, 6000 CMS™ and 6000 CMS™ IOD™ should assure that it is used in such an environment.			
IMMUNITY test	IEC 60601 test level	Compliance level	Electromagnetic environment - guidance
<p>Conducted RF</p> <p>IEC 61000-4-6</p>	<p>3 Vrms</p> <p>150 kHz to 80 MHz 1 KHz 80% AM modulation</p>	<p>[V₁] V</p> <p>3V / m</p>	<p>Portable and mobile RF communications equipment should be used no closer to any part of the Painsmart™ IOD, 6000 CMS™ and 6000 CMS™ IOD™ including cables, than the recommended separation distance calculated from the equation applicable to the frequency of the transmitter.</p> <p>Recommended separation distance</p> <p>$d = \left\lceil \frac{3.5}{E_1} \sqrt{P} \right\rceil$ d = 1.17 \sqrt{P} 80 MHz to 800 MHz</p> <p>$d = \left\lceil \frac{3.5}{E_1} \sqrt{P} \right\rceil$ 80 MHz to 800 MHz</p> <p>$d = \left\lceil \frac{7}{E_1} \sqrt{P} \right\rceil$ 800 MHz to 2.5 GHz d = 2.33 \sqrt{P} 80 MHz to 2.56 GHz</p> <p>Where P is the maximum output power rating of the transmitter in watts (W) according to the transmitter manufacturer and d is the recommended separation distance in meters (m).</p> <p>Field strengths from fixed RF transmitters, as determined by an electromagnetic site survey, should be less than the compliance level in each frequency range</p> <p>Interference may occur in the vicinity of equipment marked with the following symbol:</p> 
<p>Radiated RF</p> <p>IEC 61000-4-3</p>	<p>2 V / m</p> <p>150 MHz to 2,5 GHz 1 KHz 80% AM modulation</p>	<p>[E₁] V / m</p> <p>3V / m</p>	
NOTE 1 At 80 MHz and 800 MHz, the higher frequency range applies.			
NOTE 2 These guidelines may not apply in all situations. Electromagnetic propagation is affected by absorption and reflection from structures, objects and people.			
<ul style="list-style-type: none"> Field strengths from transmitters, such as base stations for radio (cellular / cordless) telephones and land mobile radios, amateur radio, AM and FM radio broadcast and TV broadcast cannot be predicted theoretically with accuracy. To assess the electromagnetic environment due to fixed RF transmitters, an electromagnetic site survey should be considered. If the measured field strength in the location in which the [ME EQUIPMENT or ME SYSTEM] is used exceeds the applicable RF compliance level above, the [ME EQUIPMENT or ME SYSTEM] should be observed to verify normal operation. If abnormal performance is observed, additional measures may be necessary, such as re-orienting or relocating the [ME EQUIPMENT or ME SYSTEM]. Over the frequency range 150 kHz to 80 MHz, field strengths should be less than [V₁] V / m. 			

Clinician Information and Access Code

*This chapter should be removed before initial patient training and instruction on the **Moog Curlin Infusion** pump so the intended locked functions or secured functions of the pump cannot be accessed except by a trained clinician. Removal of this chapter will assist in patient safety.*

Whenever it is necessary for the clinician to unlock a secured lock setting, depending on the configuration of the pump, one of the following screens will appear:



Depending on the version of your pump, the clinician enters a five-digit access code or a four-digit personal identification number followed by the five-digit access code. If the five-digit code is valid, the display will automatically move to the requested screen or field. The four-digit personal identification number appears on the screen but the access code numbers are displayed as five asterisks. **The personal identification number is recorded in the history file for the purpose of providing an audit trail.** If an invalid access code is accidentally entered, a message displays: “Invalid Code” and the clinician can reenter the correct code.

Note: After entering the access code, DO NOT press the YES/ENTER key. The pump will automatically recognize the correct code and give you access to the secured section. Entering the clinician access code **does not** change the lock setting of the pump but does allow the clinician to perform the locked-out function.

Lock Setting Table

The following table illustrates which features are controlled under which lock settings:
 “No” indicates that the correct access code must be entered in order to perform the pump operation.

Pump Operation	Active Therapy	Lock OFF	Lock 1	Lock 2	Lock 3
Change Lock Settings	PCA	All settings with correct access code			
Turn Pump Off/On	PCA	Yes	Yes	Yes	Yes
Pause/Run Therapy	PCA	Yes	Yes	Yes	Yes
Access Help/Options	PCA	Yes	Yes	Yes	Yes
Check Power Source	PCA	Yes	Yes	Yes	Yes
Resume Therapy	PCA	Yes	Yes	Yes	Yes
View Rx Screens At “No To Review”	PCA	Yes	Yes	Yes	Yes
Repeat Therapy	PCA	Yes	Yes	Yes	No
Prime Pump	PCA	Yes	Yes	No*	No
Change Audio Level	PCA	Yes	Yes	Yes	No
Change Rx Screen Information	PCA	Yes	Yes	No	No
Change Rx Screen At “No To Review”	PCA	Yes	Yes	No	No
Access New Program	PCA	Yes	No	No	No
Change Air-In-Line Setting	PCA	Yes	No	No	No
Change Down Pressure	PCA	Yes	No	No	No
Change Units (New Program)	PCA	Yes	No	No	No
Change Concentration (New Program)	PCA	Yes	No	No	No
Utilize MedLMTS™ Option	PCA	Yes	Yes	No	No
Program MedLMTS™ Limits	PCA	Yes	No	No	No
Change Administration Route (New Program)	PCA	Yes	No	No	No
Program Loading Dose	PCA	Yes	No	No	No
Program Clinician Dose	PCA	No	No	No	No

*** Lock Level 2 only requires an access code to prime in the PCA mode. In software version 6R9E and Version 2 (Protocol Library pump), Lock Level 2 only requires an access code in the PCA mode unless otherwise dictated by the protocol.**

Note: To determine the software version of the pump, turn the pump on and review the screen that appears after the “PainSmart IOD” screen and immediately before the “POWER SOURCE INTERNAL POWER” screen appears.

Whenever a Lock Level setting is placed in the pump it is retained unless:

1. The setting is changed by using either the “BioMed SETUP” function or the OPTIONS function.

Note: Entering a new program will NOT change the Lock Level from its current setting.

2. The user selects a preprogrammed Protocol from a Protocol Library Safety System-enabled pump. In this case, the pump defaults to the Protocol and erases the Lock Level setting.

If a locked-out function is requested, such as PRIME in lock setting 3, a screen will appear requesting the entry of the access code. When the correct code is entered, the locked out function can be performed by the clinician.

Note: In any function outside of the field to change the Lock Level, entering the clinician access code will not change the Lock Level setting. Once the pump recognizes the clinician access code, it authorizes the function to be performed without the need to change the Lock Level setting.

PainSmart™ IOD Catalog Numbers

PAINSMART™ IOD CATALOG NUMBERS					
Catalog Number	Units	Default Route	Fixed Route	# Lock Code Digits	Lens Color
360-1300-PE1	mL		EPI	5	Yellow
360-1300-PE2	mL		EPI	9	Yellow
360-1300-PE3	mL	IV		9	Gray
360-1300-PE4	mL	EPI		9	Gray
360-1300-PE5	mg	IV		5	Gray
360-1300-PE6	mg	IV		9	Gray
360-1300-PE7	mL	IV		5	Gray
360-1300-PE8	mg		IV	9	Green
360-1300-PE9	mL	EPI		5	Gray
360-1300-PE10	mg		IV	5	Green

Pump has been factory configured to specifications indicated in the above columns. Therefore, all options indicated in the manual will not be available. Pump will function according to set specifications.
