

Datex-Ohmeda S/5 Light Monitor

User's Reference Manual



Conformity according to the Council Directive 93/42/EEC concerning medical devices

CAUTION: U.S. Federal and Canadian law restricts this device to sale by or on the order of a licensed medical practitioner. Outside the USA and Canada, check local laws for any restriction that may apply.

Document No. 8000056-2

April 2003

Datex-Ohmeda, Inc.
P.O. Box 7550, Madison
WI 53707-7550, USA
Tel. +1-608-221-1551
Fax +1-608-222-9147
www.us.datex-ohmeda.com

Datex-Ohmeda Division,
Instrumentarium Corp.
P.O. Box 900, FIN-00031
DATEX-OHMEDA, FINLAND
Tel. +358 10 39411 Fax +358 9 146 3310
<http://www.datex-ohmeda.com/>

© Instrumentarium Corp. All rights reserved.

Intended purpose

Datex-Ohmeda S/5 Light Monitor is intended for stationary and mobile monitoring of patient's ECG, SpO₂, non-invasive and invasive blood pressure, temperature, respiration and CO₂ in hospitals and ambulances. When used outdoors, the monitor must be in the protective case.

The monitor is intended for use by qualified medical personnel only.

The S/5 Light Monitor is intended for patients with weight from 5 kg (11 lb.) up.

Respiration monitoring is intended for patients three years old and up.

Classification according to IEC 60601-1

- CLASS I EQUIPMENT and INTERNALLY POWERED EQUIPMENT according to the type of protection against electrical shock.
- TYPE BF or CF equipment according to the degree of protection against electric shock is indicated with a symbol beside each patient connector.
- Degree of protection against harmful ingress of water as detailed in the IEC 60529:
Monitor: IPX1, vertically falling water drops shall have no harmful effects (applicable when the monitor is in upright position, or tilted backwards). In the protective case IPX4, splash proof, when the case is closed properly, the monitor is intact and operates on battery power.
Power adapter: IPX0, ordinary equipment.
Power Adapter for Transport Vehicles: IPX1.
- EQUIPMENT not suitable for use in the presence of a FLAMMABLE ANESTHETIC MIXTURE with air or with oxygen or nitrous oxide.
- CONTINUOUS OPERATION according to the mode of operation.

Classification according to EU Medical Device Directive

- The monitor is classified as IIb.

Responsibility of the manufacturer

Instrumentarium Corp. is responsible for the effects on safety, reliability and performance of the equipment only if:

- assembly, operations, extensions, readjustments, modifications, service and repairs are carried out by authorized personnel.
- the electrical installation of the relevant room complies with appropriate requirements.
- the equipment is used in accordance with this manual.

The CO₂ measuring option (N-LCM) is manufactured for Instrumentarium Corp. by Pryon Corp., 8500 S.W. Creekside Place, Beaverton, OR 97008-7107 USA.

The Nellcor option (N-LNSAT) is manufactured for Instrumentarium Corp. by Mallinckrodt Inc., 675 McDonnell Boulevard, P.O. Box 5840, St. Louis, MO 63134 USA.

Trademarks

ComWheel, Datex-Ohmeda AS/3, Datex-Ohmeda CS/3, Light, EarSat, FingerSat and Flexlite are trademarks of Instrumentarium Corp.

© Instrumentarium Corp. All rights reserved.

Table of contents

1.	How to Use THIS MANUAL	1
	Related documents	1
	Symbols and abbreviations.....	2
	Symbols on the equipment	2
	Symbols used in this manual.....	4
	Chapter symbols	4
	Abbreviations	5
	Conventions used in this manual	6
2.	SAFETY	7
	Warnings	7
	EXPLOSION HAZARD.....	7
	ELECTRICAL SHOCK HAZARD.....	7
	PATIENT SAFETY	8
	Cautions.....	9
	BATTERY CAUTIONS	10
3.	Unpacking and Installation	11
	Unpacking.....	11
	Placing	11
	Electrical Power Adapter.....	12
	Charge batteries	13
	Connecting to network	13
	Configuration	13
	Disposal	14
4.	Description	15
	Parts of the monitor	15
	Rear panel.....	16
	Keys and controls.....	17
	ComWheel	17
	Display.....	18
	Measurement connectors.....	19
5.	Operation	20
	Getting started.....	20
	During monitoring.....	20
	In-between patients.....	20
	At the end of the day	20
	Using menus	21

6.	Batteries	22
	Charging batteries.....	22
	Charging in the monitor	22
	Removing batteries from the Battery Module	23
	Battery alarms.....	23
	Storing and disposing of batteries.....	23
7.	Cleaning	25
	Dust filter	26
	Monitor casing.....	26
	Pulse oximetry sensors	26
	ECG cables, temperature probes, NIBP hose	26
	NIBP cuff	27
	Invasive pressure cables.....	27
	Airway accessories.....	27
	Adapters.....	27
	Mainstream CO ₂ sensor.....	27
8.	ALARMS	29
	Alarm categories.....	29
	Smart start alarms.....	30
	Silencing alarms	30
	Silencing alarms for two minutes.....	31
	Turning audible alarms on and off	31
	Alarm messages	32
	Alarms setup and adjustments	32
	Adjusting alarm limits.....	32
	Other settings	33
	Automatic alarm recording.....	33
	Alarm tables.....	34
	Alarm sources.....	34
	Default limits.....	34
	Auto alarm limits	36
9.	MONITOR SETUP	38
	Screen setup	38
	Selecting waveforms.....	38
	Selecting numerical display fields	39
	Setting time & date	40
	Install/Service menu.....	41
	Default settings	41

10.	TRENDS	45
	Viewing graphic trends	46
	Graphic trend pages.....	46
	Viewing numerical trend	48
	Changing trend setup.....	49
	Erasing trend data.....	49
11.	Patient Data	50
12.	Recording and Printing	52
	Recording.....	52
	Selecting the waveforms to be recorded.....	52
	Recording trends.....	53
	Other recorder settings.....	53
	Recorder paper replacement.....	54
	Printing.....	54
	Selecting the printer	54
	Selecting the paper size	55
	Printer installation.....	55
	Printer setup.....	55
13.	Network and DataCard	56
	Networking.....	56
	Patient view and multi view on the Datex-Ohmeda Central screen	56
	Monitor-to-Monitor communication.....	57
	DataCard.....	57
	Inserting and removing the card	57
	Collecting data.....	58
14.	ECG	59
	Monitoring ECG.....	59
	Applying electrodes	59
	Patient preparation.....	59
	Placing electrodes	60
	Electrode coding	60
	Selecting trunk cable	61
	What should happen when electrodes are applied ?.....	61
	Selecting ECG lead	61
	ECG display.....	61
	Cascaded ECG.....	62
	ECG adjustments	62
	ECG setup.....	63
	Setting heart rate alarm	64

Pacemaker patients	64
15. Respiration	65
Monitoring respiration.....	65
Patient connections	65
Respiration setup	65
Limitations of measuring	66
Measuring principle.....	67
16. Pulse Oximetry	68
Monitoring pulse oximetry.....	68
Selecting sensor	69
Applying sensors.....	69
What should happen when sensor is applied ?	70
Pulse oximetry display.....	70
Measuring limitations	70
Adjustments.....	71
Setting SpO ₂ alarms	72
Measuring principle.....	72
Alternative SpO ₂ measurement.....	73
Nellcor® sensors	73
17. TEMPERATURE	74
Monitoring temperature	74
Temperature display	74
Temperature testing	74
Temperature setup.....	75
18. NON-INVASIVE BLOOD PRESSURE (NIBP)	76
Monitoring NIBP	76
Display of NIBP measurement	77
Automatic NIBP double check.....	78
Using NIBP functions	78
Starting/Stopping autocycle	79
Starting a manual measurement.....	79
Canceling any measurement.....	79
Starting a continuous measurement (STAT)	80
Using venous stasis.....	80
NIBP adjustments	81
Calibration check.....	81
NIBP alarms	82
Measuring principle.....	82

19.	INVASIVE BLOOD PRESSURE	83
	Monitoring invasive pressures	83
	Preparing pressure line.....	83
	Zeroing transducer.....	84
	Invasive pressure display.....	85
	Adjustments.....	86
	Labeling the invasive line.....	86
	Changing the scale	87
	Other invasive pressure setup adjustments.....	87
	Invasive pressure alarms	88
	Measuring principle	88
20.	Carbon Dioxide, CO₂	89
	Monitoring mainstream CO ₂	89
	Display of CO ₂ measurement.....	90
	CO ₂ adjustments	91
	Calibration check	91
	Unit conversions	92
	Measuring principle	92
21.	MAINTENANCE AND TROUBLESHOOTING	93
	Maintenance.....	93
	Once a month	93
	Once a year	93
	Checklist	93
	General	93
	ECG/Respiration.....	94
	Pulse oximetry	94
	Temperature.....	95
	Non-invasive blood pressure NIBP.....	95
	Invasive blood pressure.....	96
	CO ₂	96
	Battery packs and Module	96
	Alarm and information messages	97
	ECG	97
	Impedance respiration	98
	Invasive blood pressure.....	98
	NIBP.....	99
	Temperature.....	101
	Pulse oximetry	101
	CO ₂	102
	DataCard	103

Battery.....	104
Recorder	104
Other messages.....	105
Troubleshooting.....	106
22. GENERAL SPECIFICATIONS	107
Parameter specifications.....	107
ECG.....	107
Impedance respiration	107
Pulse oximetry (SpO ₂)/Pleth.....	108
Temperature.....	109
Non-invasive blood pressure.....	109
Invasive blood pressure (F-LMP1 models only)	110
General.....	111
Environmental conditions	112
Display.....	112
Trends.....	113
Alarms.....	113
Light Monitor Battery Module (optional) (w/2 battery slots)	113
S/5 Light Monitor Backup Battery (optional)	113
External Power Adapter	114
Power Adapter for transport vehicles (optional)	114
Option codes.....	114
Nurse call and defibrillator synchronization signals	115
23. Accessories	117
24. INDEX	i



1. HOW TO USE THIS MANUAL

This manual describes how to use and maintain the Datex-Ohmeda S/5 Light Monitors F-LM1 and F-LMP1.

The **General** section gives you information about safety aspects and installation. Get acquainted with them before using the monitor.

The **Basic Operation** section helps you through the daily basic use of the monitor.

The **Detailed Operation** section describes the monitor functions in detail. These chapters are necessary if you want to master all the features available in the monitor.

The **Troubleshooting/Specifications** and **Index** sections help you find the information you need in various situations.

NOTE: Before using your monitor, please read this manual. Pay special attention to WARNING and CAUTION statements.

Related documents

S/5 Light Monitor Technical Reference Manual

The Technical Reference Manual provides detailed technical descriptions and instructions for the service, maintenance procedures and troubleshooting.

Light Monitor Schematic Diagrams

The Schematic Diagrams provide schematic diagrams and part layouts for the monitor.

Patient Monitor Supplies and Accessories













The Patient Monitor Supplies and Accessories Catalogue provides information on all supplies and accessories available for the monitor.







Symbols and abbreviations

Symbols on the equipment





	Attention, consult accompanying documents.
on the rear panel indicates the warning:	Electric shock hazard. Do not open monitor frame. Refer servicing to qualified personnel. Do not touch any part of the monitor or patient connections during defibrillation procedure. Disconnect power supply before servicing.
on the rear panel dust filter indicates the reminder:	Check rear panel dust filter regularly, and clean at least once a month.
on the patient connector panel indicates the warnings and cautions:	Use only the specified cables and accessories. Ensure proper contact of the return electrode of the electrosurgery unit to your patient to avoid possible burns at ECG electrode or other probe sites. The output signals are not floating and must not be connected directly to a patient.
on the external power adapter indicates the cautions:	For continued protection against fire hazard, replace only with same type and rating of fuse. Make sure voltage selector is set according to local voltage. For indoor use only. For patient transport outdoors, use the monitor in its protective case and with battery power only. Do not immerse in liquid or allow any liquid to enter the interior.
on the battery unit indicates the warnings and cautions:	Do not put in fire. Do not short-circuit any terminals. Do not disassemble or mutilate. Use only with Battery Module or External Battery Charger. Discharge and charge batteries fully once a month to restore full capacity. Sealed NiCd battery must be recycled or disposed of properly. Discharge before disposing.
on the CO ₂ sensor:	Do not immerse the sensor in liquids or autoclave it.

	SpO ₂ , CO ₂ : Type BF (IEC-60601-1) protection against electrical shock, not defibrillation proof.
	NIBP: Type BF (IEC-60601-1) defibrillator-proof protection against electrical shock.
	Temperature: Type CF (IEC-60601-1) protection against electrical shock.
	ECG, Impedance Respiration, P ₁ , P ₂ : Type CF (IEC-60601-1) defibrillator-proof protection against electrical shock.
 Ni-Cd	Battery packs contain heavy metal cadmium (chemical symbol Cd) and in case of disposal, must be separated from other waste according to local regulations.
 Ni-Cd	Battery packs contain Ni-Cd and they can be recycled.
IPX-class:	Degree of protection against harmful ingress of water as detailed in the IEC 60529:
IPX0	- ordinary equipment
IPX1	- vertically falling water drops shall have no harmful effects
IPX4	- splash proof
	Battery charging LEDs: LEDs are blinking while batteries are being charged and stay illuminated when batteries are fully charged and the monitor is connected to mains.
	The monitor is connected to the network (optional).
	The DataCard (option) is inserted. If symbol is blinking, the card is faulty or it is not inserted properly.
	A blinking heart next to the heart rate or pulse rate value indicates the beats detected.
	A lung next to the respiration rate value indicates that respiration rate is calculated from the impedance respiration measurement.
	Silence alarm indicator. When displayed on the upper left corner of the screen, indicates that all the alarms are silenced. When in the menu or digit fields, indicates that the alarm source has been turned off.
	Alternating current



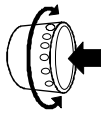

-  Input voltage
-  Output voltage
-  Ethernet connectors
-  Printer connector
-  Sample gas outlet
-  Do not immerse the sensor in liquids.

Symbols used in this manual

-  Indicates the procedure for making adjustments (turn and press) in the menus.
-  Submenu. Selecting a menu item with this symbol opens a new menu.

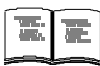



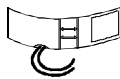
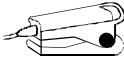
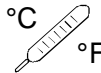

Chapter symbols

General chapters

-  General information
-  Operation
-  Alarms
-  Trends

Measuring parameter chapters

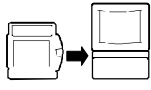
-  ECG
-  NIBP
-  Pulse oximetry
-  Temperature

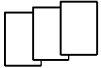
	Recorder		Invasive pressure
	Monitor setup		CO ₂
	Networking and DataCard		Impedance respiration
	Patient data		

Abbreviations

Blood pressure:

Art	arterial pressure
CVP	central venous pressure
ICP	intracranial pressure
Inv.	invasive
Mean	mean of diastolic and systolic pressures
NIBP	non-invasive blood pressure
P	blood pressure
PA	pulmonary arterial pressure
S/D	systolic/diastolic

Temperature:

Temp	temperature
AirW	airway temperature
Axil	axillary temperature
Blad	bladder temperature
Eso	esophageal temperature
Myo	myocardial temperature
Naso	nasopharyngeal temperature
Rect	rectal temperature
Room	room temperature
Skin	skin temperature
Temp	temperature
Tymp	tympanic temperature
Core	central temperature
Surf	surface temperature

Miscellaneous:

Casc	cascaded ECG waveform
ECG	electrocardiography
EL	electroluminescence (display)
HR	heart rate
LED	light emitting diode
Pleth	plethysmograph waveform
P/N	part number
PR	pulse rate
SpO ₂	oxygen saturation measured by pulse oximeter
MS	mainstream CO ₂ measurement
SN, S/N	serial number

Conventions used in this manual

Names of the keys appear in bold typeface: **Normal Screen**.

Selectable menu items appear in bold and italic typeface: ***Previous Menu***.

Informative messages displayed on the screen are enclosed in single quotes: 'Please wait'.

2. SAFETY

Warnings

WARNING Indicates situations in which the user or the patient may be in danger of injury or death.

EXPLOSION HAZARD

- Do not use the monitor in presence of flammable anesthetics.

ELECTRICAL SHOCK HAZARD

- Do not remove cover. Refer servicing to qualified service personnel.
- Use only hospital-grade grounded electrical outlets and power cord. Grounding reliability can only be achieved when the equipment is connected to a receptacle marked 'hospital grade'.
- Make sure that external equipment is hospital grade grounded before you connect it to the monitor. Do not connect any external equipment to the monitor, except that specified by Datex-Ohmeda.
- When connecting external equipment to monitor, make sure that the whole combination complies with safety standard IEC 60601-1-1 for the medical electrical systems and with the requirements of local authorities. A non-medical electrical equipment connected to monitor shall be supplied from an extra separating transformer with a protectively grounded power outlet.
- Before cleaning, disconnect the monitor from electrical outlet.
- Do not immerse any part of the monitor in liquids or allow liquid to enter the interior.
- Do not autoclave any part of the monitor with steam or ethylene oxide.
- After cleaning, or if liquid has accidentally entered the interior of the monitor, make sure that every part of the monitor is dry before reconnecting it to the power supply.

PATIENT SAFETY

- Always make sure that necessary alarm limits are set and operative when you start monitoring.
- When the alarms are suppressed, observe the patient frequently.
- Connect only one patient to one monitor at a time.
- Constant attention by a qualified professional is needed whenever a patient is under anesthesia or connected to a ventilator. Some equipment malfunctions may pass unnoticed in spite of the monitor alarm.
- Do not use antistatic or electrically conductive breathing tubes. They may increase the risk of burns when electrosurgery unit is utilized.
- Do not use the monitor during magnetic resonance imaging (MRI).
- ECG, Impedance Respiration, InvBP: Ensure proper contact of the return electrode of the electrosurgery unit to your patient to avoid possible burns at sensor sites.
- ECG, Impedance Respiration, InvBP: Make sure that no part of the patient connections touches any electrically conductive material including earth.
- Impedance Respiration: In obstructive apnea, thoracic movements and impedance variations may continue.
- NIBP: The monitor sets the inflation pressure automatically according to the first measurement. Reset the case to reset the inflation limit before measuring a new patient.
- PATIENTS WITH PACEMAKERS OR ARRHYTHMIAS: Monitor may count the pacemaker pulses as heart beats during cardiac arrest, some arrhythmias, and with certain types of pacemakers particularly in **ON R** mode. Do not rely entirely upon rate meter alarms. Keep patients with pacemakers and arrhythmias under close surveillance.
- PACEMAKER PATIENTS: The impedance respiration measurement may cause rate changes in Minute Ventilation Rate Responsive Pacemakers. Set the pacemaker rate responsive mode off or turn off the impedance respiration measurement on the monitor.
- SpO₂: A damaged sensor or a sensor soaked in liquid may cause burns during electrosurgery.

- SpO₂: Change measuring site frequently. Change the sensor site and check skin and circulatory status every 2-4 hours with adults and every hour with small children.
- The output signals are not floating and must not be connected directly to a patient.
- Do not use delayed analog signals for defibrillator or intra-aortic balloon pump synchronization.
- The monitor is intended for use by qualified medical personnel only.
- InvBP: All invasive procedures involve risks to the patient. Use aseptic technique. Follow catheter manufacturer's instructions.
- InvBP: Use only defibrillator proof cables and transducers.

Cautions

CAUTION Indicates situations in which the unit or devices connected to it may be damaged.

- Use licensed patient cables and accessories only, see Patient Monitor supplies and accessories catalogue. Other cables and accessories may damage the system or interfere with measurement.
- Before connecting the power cord, ensure that the input voltage selector is set correctly in the external power adapter.
- Use the monitor outdoors with the battery power only.
- Do not store the monitor beyond the specified temperature range.
- Do not use hypochlorite, ammonia-, phenol- or acetone-based cleaners. They may damage the monitor.
- Clean rear panel fan dust filter once a month or whenever needed.
- Leave space around the monitor for ventilation to prevent the monitor from overheating.
- Do not apply pressurized air to any outlet or tubing connected to the monitor. Pressure may destroy sensitive elements.
- When used in moving vehicle, mount the monitor properly.
- Dispose of the device and parts thereof in accordance with local regulations.

- Vibrations during transport may disturb SpO₂, ECG, impedance respiration and NIBP measurements.
- CO₂, SpO₂: Do not apply force to sensors or sensor cables.
- DataCards: Do not subject cards to excessive heat, bending, or magnetic fields.
- InvBP: Mechanical shock to invasive blood pressure transducer may cause severe shifts in zero balance and calibration and produce erroneous readings.
- Electromagnetic interference from radio-frequency transmitting devices in ambulances may affect the performance of this medical device.

BATTERY CAUTIONS

- Do not put in fire.
- Do not short-circuit any terminals.
- Do not use damaged or leaking batteries.
- Do not disassemble or break the batteries.
- Use only with Battery Module or External Battery Charger.
- Charge and discharge batteries fully once a month to restore full capacity.
- Sealed NiCd battery must be recycled or disposed of properly. Discharge before disposing.

3. UNPACKING AND INSTALLATION

Unpacking

The monitor is delivered in one box containing typically (as minimum):

- Datex-Ohmeda S/5 Light Monitor
- Datex-Ohmeda S/5 Light Monitor Power Adapter with power cord or optional Power Adapter for Transport Vehicles
- User's Reference Manual

Check that the contents correspond to your order and that all additional options you have ordered are included. If any of the items appears damaged or is missing, contact your sales person immediately.

Placing

The monitor can be placed on a flat surface or hung with the handle from bed or wall rails. Make sure that the surface or rail holds up to at least 10 kg/22 lb.

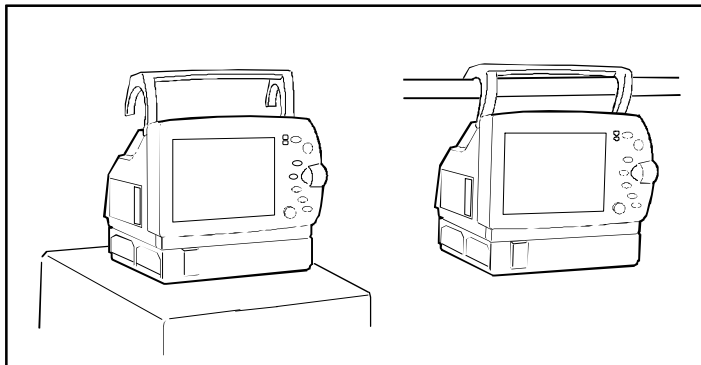

Figure 3-1 Installation

A protective case is also available. If using the case, make sure that the monitor is always in a standing position to ensure proper ventilation. The monitor is splash-proof (IPX4) when it is in the protective case and all the openings of the case are closed properly. Make sure the monitor is intact and operates on battery power. When used outdoors, the monitor must be in the protective case.

NOTE: The pocket in the protective case is not water-proof. Do not place items in the pocket that may be damaged by moisture.

Universal mounting solutions are sold separately. Contact your local distributor.

Electrical Power Adapter

Use only the power cord and power adapter provided with the monitor.

- Set the voltage selector on the adapter to the right position (115V/230V) e.g. with a pen.
- Connect the adapter cord to the connector on the rear panel.
- Connect the power cord to the adapter and then plug onto the wall electrical outlet.

NOTE: To use the power adapter, it must be lying on a flat surface or hanging from the holder.

Do not let any liquid enter the adapter.

When external power supply is in use, a green led is lit.

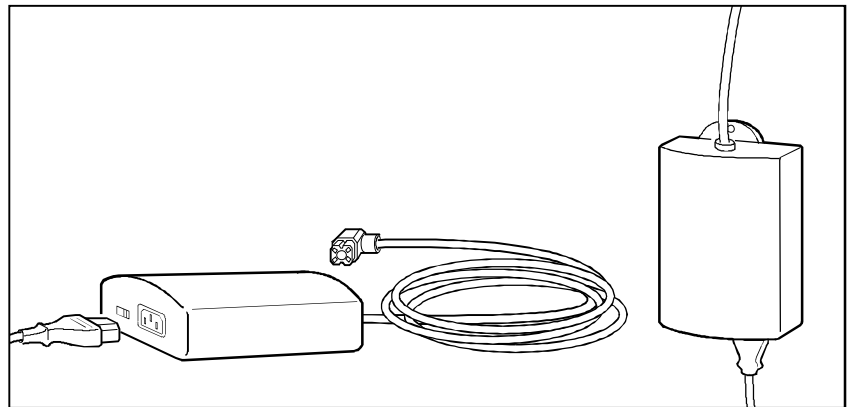

Figure 3-2 Placing Power Adapter

WARNING

ELECTRICAL SHOCK HAZARD: Use only hospital grade grounded electrical outlets.



CAUTION

Before connecting the power cord, ensure that the input voltage selector is set correctly in the power adapter.

In vehicles with 12 - 32 V power source, use the Power Adapter for Transport Vehicles, N-LPOWT. For information on how to install and use this adapter, refer to the instruction sheet provided with it, or contact your local distributor.

CAUTION Electromagnetic interference from radio-frequency transmitting devices in ambulances may affect the performance of this medical device.

Charge batteries

Keep the monitor connected to the mains outlet. The batteries are fully charged when the battery capacity indicators on the screen show FULL and green LEDs in the Battery Module stop flashing.

CAUTION When stored for longer periods, or used mostly with mains power, charge and discharge the batteries fully once a month.

Connecting to network

The monitor can be connected to a monitor network for central monitoring and printing services.

- Connect the Ethernet and location ID plug to the corresponding connectors on the monitor's rear panel.
- Configure the location IDs in the Datex-Ohmeda Central.

When the monitor is connected to the network and turned on, the network symbol is displayed on the upper right corner of the screen:



Configuration

When the monitor is delivered, it is configured with the factory default settings and is ready to use.

If you want to change the settings and make your own permanent configuration, refer to chapters "Alarms" and "Monitor setup" of this manual.

Disposal

Dispose of the monitor, or parts of it, in accordance with local environmental and waste disposal regulations.

4. DESCRIPTION

Parts of the monitor

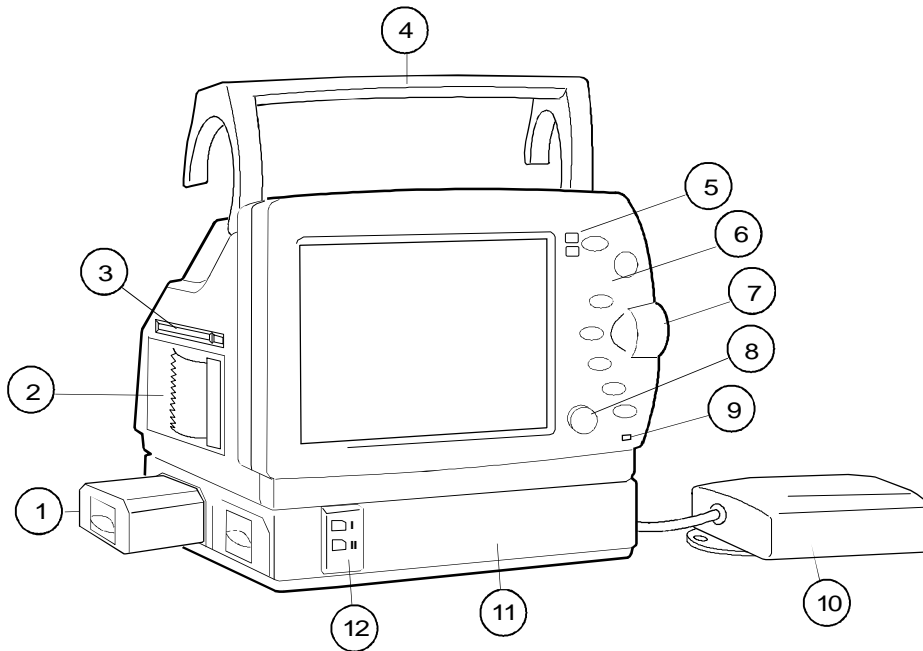

Figure 4-1 S/5 Light Monitor

- (1) Battery (2 pieces)
- (2) Recorder (option)
- (3) DataCard slot (option)
- (4) Handle with rail hooks
- (5) Alarm indicators
- (6) Function keys
- (7) ComWheel
- (8) Power On/Standby
- (9) External power indicator
- (10) External power adapter, or Power Adapter for Transport Vehicles
- (11) Battery Module (option)
- (12) Battery charge status LEDs

Rear panel

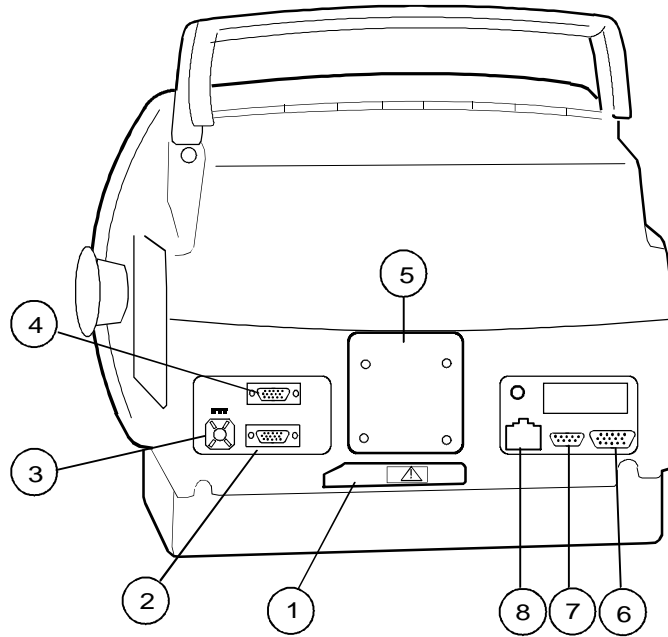











Figure 4-2 Rear panel

- (1) Dust filter 
- (2) Feature connector, X3
- (3) Connector for power adapter, X1
- (4) Printer connector (serial), X2
- (5) Mounting attachment
- (6) External VGA connector, X7
- (7) Connector for network location ID plug, X6
- (8) Network connector, X5

Keys and controls

	On/Standby.
	Returns back to normal monitoring display.
	Silences the alarm sound for two minutes.
	Calls up the main menu which enables changing the monitor settings.
	Opens NIBP mini menu for autocycling or a single non-invasive blood pressure measurement. Cancels any NIBP measurement.
	Zeroes all invasive pressure lines (except ICP which needs to be zeroed separately, see chapter "Invasive pressure").
	Stops the waveform sweep for 60 seconds. Pressing it again unfreezes the sweep.
	Starts/stops recording of selected waveforms with the built-in recorder.

ComWheel

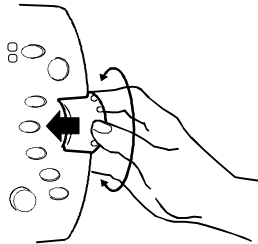

Menu functions are controlled by turning and pressing the ComWheel.

Display

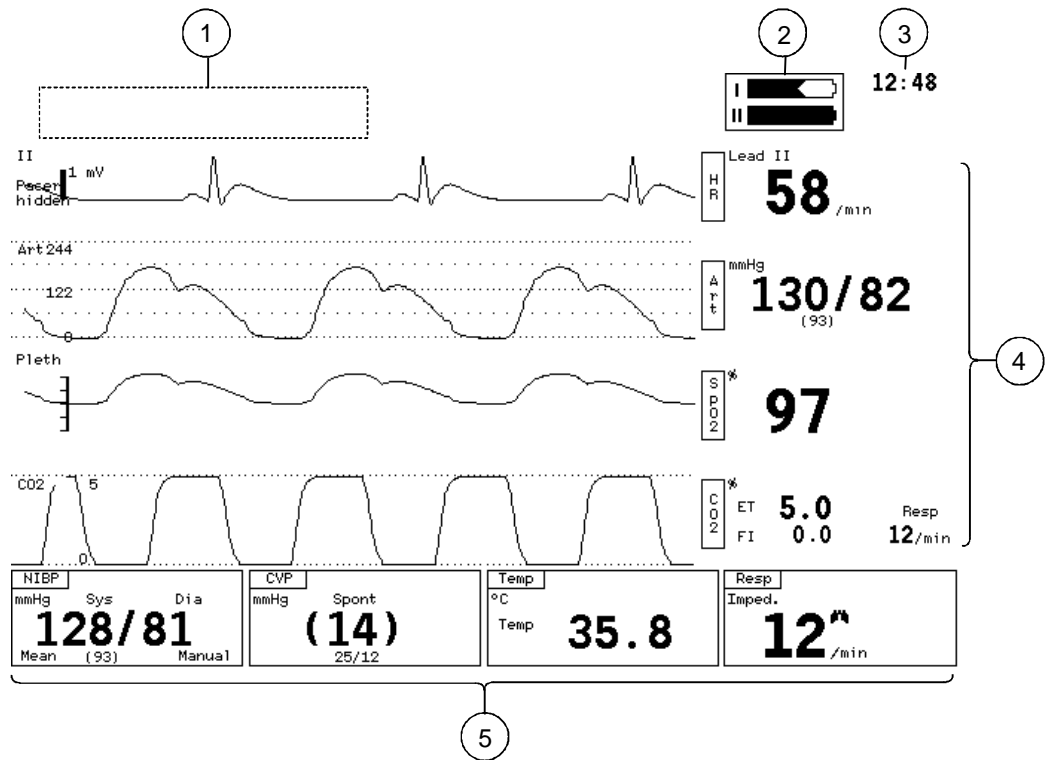

Figure 4-3 Parts of the display

- (1) Alarm message field (for five messages)
- (2) Battery status field
- (3) Actual time
- (4) Up to four waveform fields with numeric information
- (5) Up to four digit fields

The waveform and digit fields are configurable, see chapter "Monitor setup."

Measurement connectors

Connectors for measurement sensors are in the right side panel. Connectors are marked with the measurement abbreviations and symbols specifying the type of protection against electrical shock.

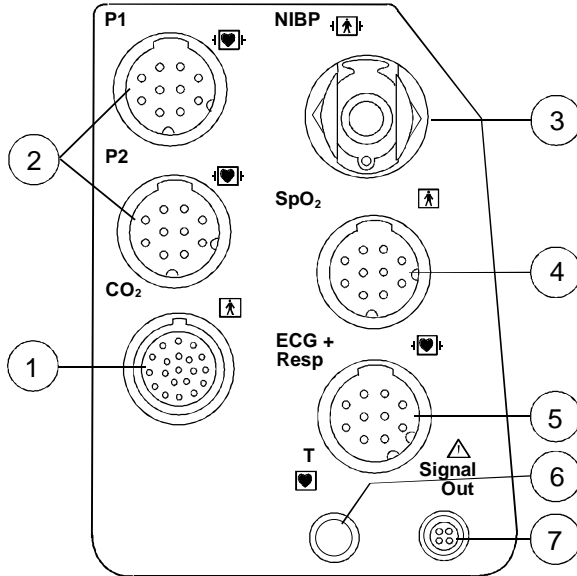



Figure 4-4 Connector panel

- (1) Mainstream CO₂ connector
- (2) Connectors for invasive pressure lines
- (3) NIBP hose connector
- (4) Pulse oximetry sensor connector
- (5) ECG trunk cable connector, also used for impedance respiration measurement
- (6) Temperature probe connector
- (7) Signal out connector 

5. OPERATION

Getting started

- Turn on the power.

After 10 seconds a start-up display will appear, the CO₂ measurement needs to warm up about 80 seconds in room temperature. If the monitor has been stored in the temperature below freezing point, it takes approximately one hour to warm up.

- Make patient connections, check the accessories.
- Zero invasive lines.
- Check that desired parameters are displayed in digit and waveform fields. If necessary, make appropriate adjustments.

During monitoring

- Ensure that ECG electrodes have a good skin contact.
- Change pulse oximetry measuring site frequently.
- Observe the cuffed limb frequently during NIBP measurement.
- If the monitor is connected to the network, the patient information and alarms can be followed on the screens of the Datex-Ohmeda Central and the S/5 monitors connected to the system.

In-between patients

- Print trends: see chapter "*Recorder.*"
- Reset previous case: Press **Menu** and select **Patient Data - Reset ALL**.
- Change single use accessories; clean reusable ones.
- Check the monitor and accessories before use.
- Plug in the power cord to charge batteries.

At the end of the day

- Turn the monitor to standby.
- Remove the power cord.
- Clean the monitor and reusable accessories. Let dry completely.
- Plug in the power cord to charge batteries.

Using menus

- Press the **Menu** key.

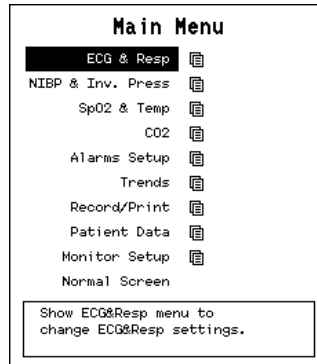

- Select the item by turning and pressing the ComWheel.

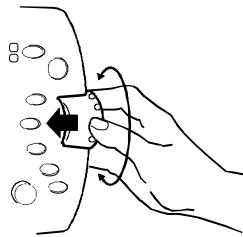

- Change settings by turning and pressing the ComWheel.

Need help?
Short instructions appear in every menu.

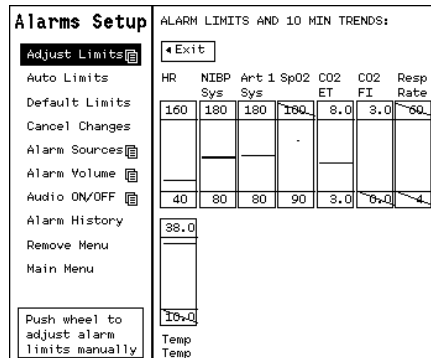

- Press **Normal Screen**.

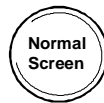

6. BATTERIES

The monitor can be equipped with either the Battery Module (F-LBAT) with two removable batteries, or the Backup Battery (N-LBB) with a built-in battery pack in the monitor basement.

Battery capacity is displayed on the battery status field. The arrow shows the discharging (left) and recharging (right) level of the battery.



The Battery Module works for two hours (one hour / battery) and Backup Battery for 30 minutes with fully charged batteries.

NOTE: Make sure that there is enough battery capacity for a patient transport.

Charging batteries

- Charge the batteries in +10...40 °C (50...104 °F) only.

Charging in the monitor

- Keep the monitor connected to power outlet. The batteries are charged when the monitor is either ON or STANDBY.
- If monitor is turned ON, an arrow to the right is displayed on the Battery Status field during charging.
- The green LEDs on the battery module keep flashing until the battery is fully charged.

Charging empty batteries to full capacity for Battery Module takes approximately 3.5 hours/battery, and for Backup Battery 1.5 hours. The protective case may increase the operating temperature so check the charging status when using it.

Removing batteries from the Battery Module

- Push the release latch down.
- The battery pops out from the frame.

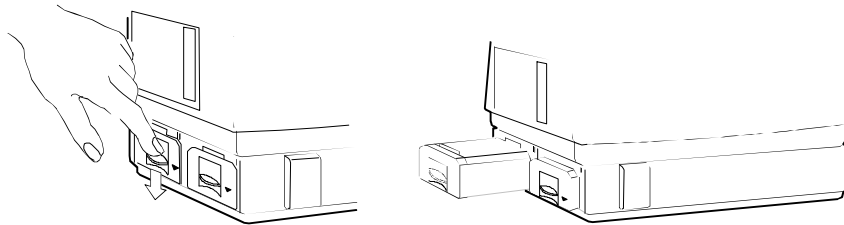

Figure 6-1 Removing battery packs from the Battery Module

Replace the batteries with new ones if the total operation time is less than one hour. Part number is 896895.

Battery alarms

If something out of normal routine happens, a corresponding message appears. These battery alarm and note messages are explained in chapter *“Maintenance and troubleshooting.”*

Storing and disposing of batteries

Keep the batteries in the monitor or external charger. If they are stored for longer periods, store them fully charged in a dry place. Before use, charge them fully.

- CAUTION Do not put in fire.
- CAUTION Do not short-circuit any terminals.
- CAUTION Do not disassemble or mutilate.
- CAUTION Use only with Battery Module or External Battery Charger.
- CAUTION Do not insert any other than specified batteries into Battery Module or External Charger.

When stored for longer periods or used mostly with mains power; charge and discharge the batteries fully once a month.



Ni-Cd

This battery contains heavy metal cadmium (Cd), and when disposed, must be separated from other waste according to local regulations.



Ni-Cd

Battery packs can be recycled. Discharge before disposing.

7. CLEANING

WARNING ELECTRICAL SHOCK HAZARD:
Before cleaning, disconnect the monitor from electrical outlet. Do not immerse any part of the monitor in liquids or allow liquid to enter the interior.
Do not autoclave any part of the monitor with steam or ethylene oxide.
After cleaning, or if liquid has accidentally entered the interior of the monitor, make sure that every part of the monitor is dry before reconnecting it to the power supply.

CAUTION Do not use hypochlorite, acetone-, phenol-, or ammonia-based cleaners.

Cleaning		
Why ?	Which items ?	How ?
To remove dirt and most microbes.	All parts daily. The items to be disinfected or sterilized.	NOTE: Always detach accessories from the monitor and the patient before cleaning. <ul style="list-style-type: none"> Wipe away visible organic material using a moist cloth and mild detergent, e.g. Datex-Ohmeda Cleaning Fluid. Rinse as recommended by the detergent manufacturer. Allow to dry completely.
Disinfecting		
To kill and remove pathogenic microbes.	Accessories and supplies in contact with the patient's skin or airways.	<p>With heat:</p> <ul style="list-style-type: none"> Wash in a washing machine (at least 1 min at 85 °C/185 °F). <p>With chemicals:</p> <ol style="list-style-type: none"> Immerse in 2% glutaraldehyde for 10 minutes (pH=6.5). After tuberculosis, HIV or hepatitis patient, the treatment time should be 20 min. Rinse carefully and let dry. <p>or</p> <ul style="list-style-type: none"> Wipe with alcohol and let dry.
Sterilization		
To kill the microbes and bacterial spores.	Accessories and supplies penetrating the patient's tissue.	<ul style="list-style-type: none"> Steam autoclave at maximum 121 °C (250 °F) for 15 min. Use ethylene oxide mixture at 50 to 60 °C (120 to 140 °F). Follow the sterilizer manufacturer's recommendations for required aeration times. Immerse in 2% glutaraldehyde for three hours, rinse carefully and let dry.

Dust filter

Clean the dust filter at least once a month:

1. Pull out the filter frame on the rear panel. Do not remove any screws!
2. Shake the filter and blow out the dust.

If the filter is damaged, replace it with a new one (p/n 886841).

Monitor casing

1. Wipe gently using a moist cloth and mild detergent.
2. Let dry completely before reconnecting the power cord.

Pulse oximetry sensors

1. Wipe the sensor with mild detergent solution.
2. Allow it to dry completely before use.

The Sat Sensors may be sterilized using ethylene oxide.

The Sat Sensors are latex free. Take possible patient allergies into account also when selecting the cleaning agent.

With the option using Nellcor sensors, see instructions in the sensor package.

WARNING **PATIENT SAFETY: A damaged sensor, or a sensor soaked in liquid, may cause burns during electrosurgery.**

ECG cables, temperature probes, NIBP hose

Wipe the cables with mild detergent solution. When necessary, use disinfectant.

Always follow the manufacturer's instructions. Disinfect only the items that tolerate the process.

NIBP cuff

Clean only when necessary:

1. Remove the bladder from the cuff.

2. Wash the bladder and the cuff in mild detergent solution. Do NOT use alcohol.

Invasive pressure cables

1. Wipe the cables with sterile alcohol-based detergent.
2. After cleaning wipe the surfaces with a cloth dampened with sterile water. Dry with a dry cloth.

Airway accessories

Adapters

Replace the single patient use adapter after each patient.

If the adapter is occluded, it can be rinsed with water and air dried. It may then be replaced into the ventilator circuit of the same patient.

Multi-use adapters can be rinsed with water and steam autoclaved. The adapter is designed to withstand 20 sterilization cycles. Before using, check that the adapter windows are dry and residue-free and that the adapter has not been damaged.

Make sure that all traces of alcohol or detergent are rinsed away or dried before connecting to the patient.

Mainstream CO₂ sensor

WARNING ELECTRICAL SHOCK HAZARD: Do not immerse the sensor in liquids or autoclave it.

Wipe the sensor with a slightly damp cotton swab. When necessary, use disinfectant.

8. ALARMS

In alarm:

- Messages (max. five messages) appear on the alarm message field at the top of the display in the priority order from left to right.
- Audible alarm is heard.
- External Nurse Call signal is active, and if the monitor is connected to the network, the alarm is passed into it.
- Yellow or red alarm indicator (LED) next to the **Silence Alarms** key is illuminated according to the alarm category.
- The measured value, which activates the alarm, flashes and an explanation may appear on the waveform, the digit field, or the alarm message field.

Alarms are active also when the parameter is not selected on the screen unless the alarm source is not turned off. See default settings in “*Alarm tables/alarm sources*” later in this chapter.

WARNING **PATIENT SAFETY: Always make sure that alarm limits are set and alarms are on when monitoring a patient.**

Alarm categories

Alarms are classified into two types, red and yellow alarms. The alarm type depends primarily upon the physiological significance and the duration of the alarm; e.g., ‘Asystole’ advances rapidly to the red category.

The alarm messages are displayed in the order of priority from left to right.

Audio alarms follow either General or ISO pattern. This selection can be made in ***Install/Service*** menu and is stored in permanent memory. Select the same pattern for all the monitors in a hospital.

Table 8-1 Alarm priority categories

Category	Visual	Audio pattern		Meaning
Red alarm	Red LED If the alarm is connected to measured values, this number field is flashed.	ISO: 3+2 beeps every 6 seconds. -----	General: Continuous string of beeps. -----	Life threatening situation.
Yellow alarm	Yellow LED If the alarm is connected to measured values, this number field is flashed.	Triple beep every 20 seconds. --- ---	Double beep every 5 seconds. -- -- -- --	Serious problem.
Note	Message is displayed.	Single beep. -	Single beep. -	Advisory note or equipment related alarm.

Smart start alarms

Alarms are automatically active once the patient connection cables are attached. Some alarms have their own specific requirements before they become active:

- Invasive pressures must be within alarm limits for 20 seconds after zeroing.
- Apnea alarm requires at least three detected breaths.
- When apnea alarm is activated, the high and low alarms of CO₂ and respiration will not be activated.

Silencing alarms

WARNING PATIENT SAFETY: Do not turn off audible alarms without assuming continuous, direct observation of the patient.

Silencing alarms also disables the external Nurse Call signal.

Silencing alarms for two minutes

- Press **Silence Alarms**.

The symbol  with a countdown timer appears on the screen, and the message is cleared from the display. Messages of new alarms also appear during silencing period. After two minutes, all silenced alarms and Nurse Call function will return to normal alarm operation.

To reactivate alarms:

- Press the **Silence Alarms** key during the silencing period.

The alarm sounds of new alarms and the Nurse Call signal are activated.

Turning audible alarms on and off

It is possible to silence only apnea, ECG and apnea alarms, or all the alarms:

- Press **Menu**.
- Select **Alarms Setup**.
- Select **Audio ON/OFF**.
- Select **Silence ECG**, **Silence Apnea**, **Silence Apnea + ECG** or **Silence ALL**.

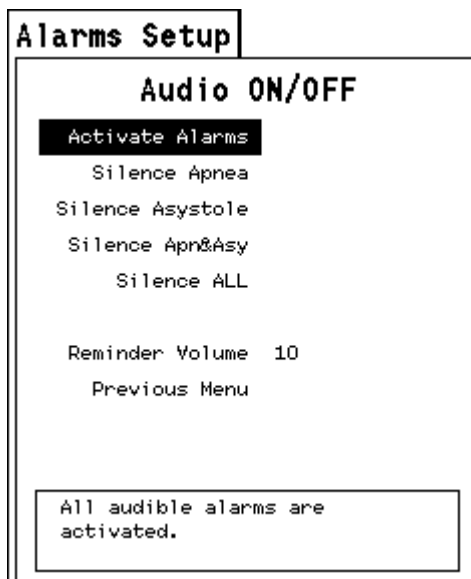

If an active alarm is suppressed, the monitor will give a reminder beep every two minutes. (Reminder beep volume can be adjusted by selecting **Reminder Volume**).

If asystole alarm is silenced, and ECG is used as the heart rate source, the HR high and low limits are also silenced.

Alarm messages

All messages are listed in chapter "Maintenance and troubleshooting."

Alarms setup and adjustments

You can adjust alarm limits and volume, silence alarms permanently, and view alarm status (a 10-minute trend) in **Alarms Setup** menu.

- Press **Menu**.
- Select **Alarms Setup**.

HR	NIBP Sys	Art 1 Sys	SpO2	CO2 ET	CO2 FI	Resp Rate
160	180	180	100	8.0	3.0	60
40	80	80	90	3.0	6.0	4

38.0
Temp
Temp

Adjusting alarm limits

Alarm limits can be adjusted individually (**Adjust Limits**) or set near to real measured patient values (**Auto Limits**).

To adjust alarm limits:

- Select **Adjust Limits**.

- Select the desired high or low alarm limit by turning and pressing the ComWheel.
- Adjust the alarm limit up or down by turning the wheel.
- Press the wheel to confirm the adjusted alarm limit.
- Turn the ComWheel to move the highlight either to the next alarm limit or to the **Exit** box.
- Press the ComWheel.
- Press **Normal Screen** to return to normal monitoring.

To set auto limits

Auto limits are calculated from the measured patient values at the time when auto limits are selected. These limits enable close patient control with individual alarms.

- Select **Auto Limits**.
- Press **Normal Screen**.

Other settings

Default Limits Sets the alarms to the default alarm limits.

Cancel Changes Returns all the values to those that were valid when the **Alarms Setup** menu was entered.

Alarm Sources NIBP and invasive pressure alarms have alternative sources, (systolic, diastolic, mean pressure, or OFF).

Alarm Volume The volume of the audio alarms can be adjusted from 1 (soft) to 10 (loud).

Audio ON/OFF All alarms or asystole alone can be turned on and off.

Alarm History Displays a list of the last 10 alarms message with respective times. Press the ComWheel to get back to **Alarms Setup** menu.

Remove Menu Only the alarm limits and 10 minute trends are displayed.

Automatic alarm recording

You can record following alarm situations:

1. Asystole
2. HR high/low and Art low simultaneously (in model with invasive pressure)

When the alarm reaches red state, the recorder will print the ECG + P1 waveforms. Printing appears 12 seconds after the alarm situation has started.

To set alarm recording, press **Menu** and select **Record&Print - Recorder Setup - Start on Alarms YES/NO**.

Alarm tables

Alarm sources

If alarm source is OFF, no alarms of this parameter occur and the parameter box with the 10 minute trend is not displayed in the **Alarm Setup** menu.

Table 8-2 Alarm source alternatives and defaults

Alarm	Source alternatives [Default selection]
P1	[Sys] Dia Mean OFF
P2	Sys Dia Mean [OFF]
Art	[Sys] Dia Mean OFF
CVP	Sys Dia Mean [OFF]
PA	Sys Dia Mean [OFF]
ICP	Sys Dia Mean [OFF]
NIBP	[Sys] Dia Mean OFF

Default limits

The monitor is delivered with a certain set of alarm limits, so called factory default limits. These are listed for each parameter in the following tables.

It is possible to save alarm adjustments as defaults, see chapter "Monitor setup", submenu "Install/Service menu."

Do not change default settings without common consent of all users. If you change the default alarm limit, write the new limits in the following table.

Table 8-3 Adjustment ranges and default settings of alarm limits

Parameter	Limit	Limit range min-max	Factory default	User default
HR	High Low	35-250 bpm 30-245 bpm	160 40	
SpO ₂	High Low	51-100 %,OFF 50-100 %	OFF 90	
NIBP	Sys High Low	15-265, OFF OFF, 15-265	180 (120 infant) 80(70 infant)	

	Mean	High Low	15-265, OFF OFF, 15-265	140(90 infant) 60(50 infant)	
	Dia	High Low	15-265, OFF OFF, 15-265	100(70 infant) 40(40 infant)	
Inv-P1	Sys	High Low	-40 -300, OFF OFF, -40-300	180 80	
	Mean	High Low	-40 -300, OFF OFF, -40-300	140 60	
	Dia	High Low	-40 -300, OFF OFF, -40-300	100 40	
Inv-P2	Sys	High Low	-40 -300, OFF OFF, -40-300	20 5	
	Mean	High Low	-40 -300, OFF OFF, -40-300	15 0	
	Dia	High Low	-40 -300, OFF OFF, -40-300	10 -5	
Art	Sys	High Low	-40 -300, OFF OFF, -40-300	180 80	
	Mean	High Low	-40 -300, OFF OFF, -40-300	140 60	
	Dia	High Low	-40 -300, OFF OFF, -40-300	100 40	
CVP	Sys	High Low	-40 -300, OFF OFF, -40-300	20 5	
	Mean	High Low	-40 -300, OFF OFF, -40-300	15 0	
	Dia	High Low	-40 -300, OFF OFF, -40-300	10 0	
PA	Sys	High Low	-40 -300, OFF OFF, -40-300	40 10	
	Mean	High Low	-40 -300, OFF OFF, -40-300	30 5	
	Dia	High Low	-40 -300, OFF OFF, -40-300	20 5	
ICP	Sys	High Low	-40 -300, OFF OFF, -40-300	20 0	
	Mean	High Low	-40 -300, OFF OFF, -40-300	15 0	
	Dia	High Low	-40 -300, OFF OFF, -40-300	10 0	
EtCO ₂		High Low	0.1 - 13%, OFF OFF, 0 - 12.9%	8%(60 mmHg, 8.1 kPa) 3%(23 mmHg, 3 kPa)	
FICO ₂		High Low	0 - 3.0 %, OFF OFF, 0 - 2.9%	3%(23 mmHg, 3 kPa) OFF	
Resp		High Low	5 - 60, OFF OFF, 4 - 59	60 4	
Temp		High Low	10 - 45 °C, OFF (50 - 113 °F, OFF) OFF, 10 - 45 °C (OFF, 50 - 113 °F)	38 °C (100 °F) 15 °C (59 °F)	

Auto alarm limits

Auto Limits are based on the measured patient values according to the following tables.

Table 8-4 Auto alarm limits

Alarm	Limit	Auto limit calculation
HR	High Low	HR x 1.25 HR x 0.75
Pulse Oximetry	Low	SpO ₂ - 5%
NIBP Sys	High Low	NIBP x 1.25 + 10 NIBP x 0.75 - 10
Mean	High Low	NIBP x 1.25 + 10 NIBP x 0.75 - 10
Dia	High Low	NIBP 1.25 + 10 NIBP x 0.75 - 10
Inv-P1 Sys	High Low	P1x 1.25 + 10 P1 x 0.75 - 10
Mean	High Low	P1 x 1.25 + 10 P1 x 0.75 - 10
Dia	High Low	P1 x 1.25 + 10 P1 x 0.75 - 10
Inv-P2 Sys	High Low	P2 x 1.25 + 5 P2 x 0.75 - 5
Mean	High Low	P2 x 1.25 + 5 P2 x 0.75 - 5
Dia	High Low	P2 x 1.25 + 5 P2 x 0.75 - 5
Art Sys	High Low	P1 x 1.25 + 10 P1 x 0.75 - 10
Mean	High Low	P1 x 1.25 + 10 P1 x 0.75 - 10
Dia	High Low	P1x 1.25 + 10 P1 x 0.75 - 10
CVP Sys	High Low	CVP x 1.25 + 5 CVP x 0.75 - 5
Mean	High Low	CVP x 1.25 + 5 CVP x 0.75 - 5
Dia	High Low	CVP x 1.25 + 5 CVP x 0.75 - 5

PA	Sys	High Low	PA x 1.25 + 10 PA x 0.75 - 10
	Mean	High Low	PA x 1.25 + 10 PA x 0.75 - 10
	Dia	High Low	PA x 1.25 + 10 PA x 0.75 - 10
ICP	Sys	High Low	ICP x 1.25 + 5 ICP x 0.75 - 5
	Mean	High Low	ICP x 1.25 + 5 ICP x 0.75 - 5
	Dia	High Low	ICP x 1.25 + 5 ICP x 0.75 - 5
EtCO ₂		High Low	EtCO ₂ + 1% EtCO ₂ - 1%
FICO ₂		High	OFF
Resp		High Low	RR * 1.25 + 2 RR * .75 - 2
Temp		High Low	Temp +1 °C (1.8 °F) Temp +1 °C (1.8 °F)

9. MONITOR SETUP

The **Monitor Setup** menu enables you to select the information displayed on the screen, to set the time and date and to change the default settings via the **Install/ Service** menu.

Getting to **Monitor Setup**:

- Press **Menu**.
- Select **Monitor Setup**.

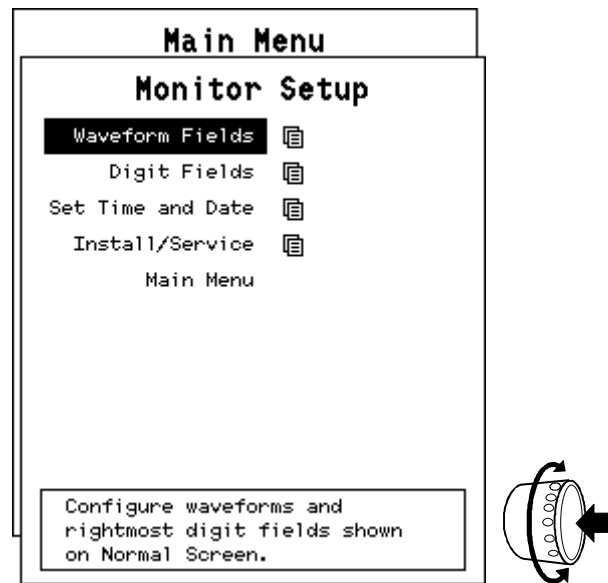

Screen setup

Select the parameters displayed in the waveform and lower digit fields. A parameter can be displayed in one place only at the time.

The monitor turns to the default settings every time it is turned off. If you want to save a certain screen setup as default, see **Install/Service** adjustments later in this chapter.

Selecting waveforms

Four waveforms can be displayed. If one field is set to 'OFF', the remaining waveforms are enlarged to fill the area.

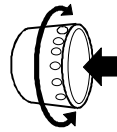
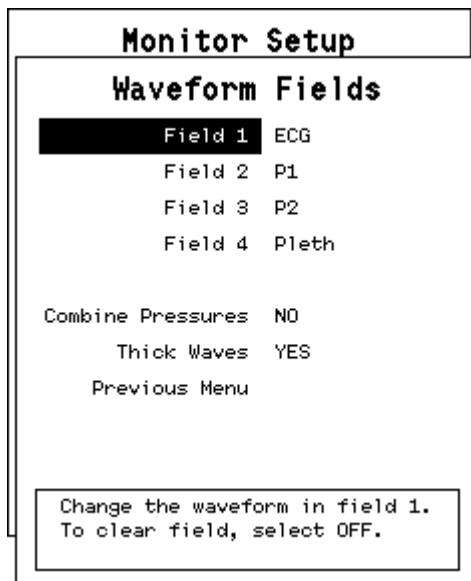

- Select **Waveform Fields**.
- Select the field you want to rearrange.
- Select the parameter from the list.
- Press **Normal Screen**.

Selecting **Combine Pressures YES** displays invasive pressures in the same field (only in models with invasive pressure).

Selecting **Thick Waves YES** draws the displayed waveforms with thicker trace.

Selecting numerical display fields

There are four fields in the lower part of the screen for numeral information, fields are numbered from left to right. If a digit field is turned OFF the digit field to its left is automatically enlarged to fill the space.

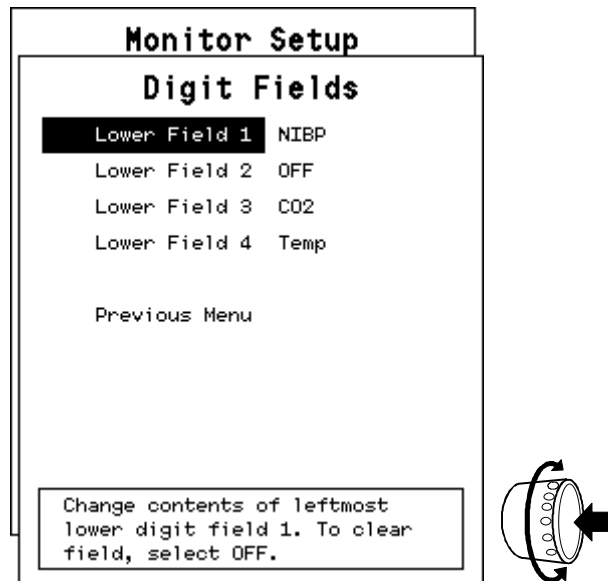

- Select **Digit Fields**.
- Select the field you want to rearrange.
- Select the parameter from the displayed list.
- Press **Normal Screen**.

Setting time & date

- Press **Menu**. Select **Monitor Setup - Set Time and Date**.

The time is shown in the upper right corner of the screen. Turning the monitor off does not affect the clock.

You can adjust hours, minutes, seconds, day, month, and year, or select the clock format of either 12 or 24 hours.

CAUTION

Do not change the monitor's time settings during patient monitoring. Trend data may be lost.

NOTE: If the monitor is connected to network, the time is set by the network, and cannot be adjusted in the monitor.

Install/Service menu

To enter **Install/Service** menu, a password 16-4-34 must be given.

Service View Service View is for a qualified technician only. It is entered with a password.

Alarm Tones Select **ISO** or **General** pattern, see chapter "Alarms."

Save As Defaults

Saves permanently your new settings and configurations.

The choices are **Save ALL**, **Screen Setup**, **Trend Setup**, **Alarm Settings**, **Recorder Setup** and **Param. Defaults**.

Select **Save** to save settings, **Cancel** to cancel changes, or **Factory** to return to the factory settings.

Analog outputs Select the parameter for four analog outputs, as default, they all are off.

Channel	Pin	Selection range
1	#3 in Signal Out connector	ECG or test signals
2	#4 in Signal Out connector	P1 or test signals
3	#5 in feature connector	freely selectable
4	#10 in feature connector	freely selectable

Previous Menu Return to **Monitor Setup** menu.

Default settings

Default settings are always on when the monitor is turned on. They are marked in the following tables with brackets.

If you change the default settings using **Save as Defaults**, please write them down in the empty column. Do not change default settings without common consent of all users.

Table 9-1 Monitor setup selections and factory defaults

Monitor settings		
Parameter	Alternatives [Default selection]	User default
Waveform Fields		
Field 1	OFF [ECG] P1 P2 PLETH CO2 Resp	
Field 2	[OFF] ECG P1 P2 PLETH CO2 Resp (*P1, **Pleth, ***P1)	
Field 3	OFF ECG P1 P2 [PLETH] CO2 Resp (**CO2)	
Field 4	[OFF] ECG P1 P2 PLETH CO2 Resp (**CO2)	
Combine Pressures	YES [NO]	
Thick Waves	[YES] NO	
Digit Fields		
Lower Field 1	OFF HR P1 P2 [NIBP] SpO2 CO2 Resp Temp	

Lower Field 2	[OFF] HR P1 P2 NIBP SpO2 CO2 Resp Temp(*P2, ***P2)	
Lower Field 3	OFF HR P1 P2 NIBP SpO2 CO2 Resp [Temp]	
Lower Field 4	OFF HR P1 P2 NIBP SpO2 CO2 [Resp] Temp (**OFF)	
Set Time and Date		
Clock Format	12 [24]	
Parameter settings		
ECG		
ECG Lead	I [II] III	
Size	[1.0] 0.2-5.0	
Beat Sound Volume	[0] 0-10	
ECG Setup		
Sweep Speed	12.5 [25] 50	
HR Source	[AUTO] ECG Pleth	
Grid	ON [OFF]	
Pacemaker	Show [Hide] On R	
Pulse Oximetry		
Beat Sound Volume	[0] 0-10	
Pleth Scale ****	AUTO 50 [20] 10 5 2	
SpO2/Pleth Setup		
Sweep Speed	12.5 [25] 50	
HR Source	[AUTO] ECG Pleth	
SpO2 Response	B-to-B Normal [Slow] with N-LNSAT selections are: Fast Normal [Slow]	
Temperature		
Temp Setup		
Unit	[°C] °F	
Label	[Temp] Eso Naso Tymp Rect Blad Axil Skin AirW Room Myo Core Surf	
Invasive Pressures		
P1 Setup		
Label	P1 [Art] CVP ICP PA	
Scale	[200] 10-300	
Digit Format	[S/D] Mean	
Sweep Speed	12.5 [25] 50	
HR Source	[AUTO] ECG Pleth	
P2 Setup		
Label	P2 Art [CVP] ICP PA	
Scale	[20] 10-300	
Digit Format	S/D [Mean]	
Sweep Speed	12.5 [25] 50	
HR Source	[AUTO] ECG Pleth	



NIBP		
Set Cycle Time	1 2.5 3 5 10 [15] 30 60	
NIBP Setup		
Ready Prompt	[5] 0-10	
Inflation Limits	150 200 [280] mmHg	
CO2		
Scale	[6] 10 15 (% kPa) (50 80 100 mmHg)	
Unit	[%] kPa mmHg	
Sweep speed	[Fast] Slow	
MS or OFF	[MS] OFF	
Recording and Printing		
Parameter	Alternatives [Default selection]	User default
Waveform 1	OFF [ECG] P1 P2 PLETH	
Waveform 2	[OFF] ECG P1 P2 PLETH (*P1, **Pleth, ***P1,)	
Waveform 3	OFF ECG P1 P2 [PLETH] (**CO2, ***CO2)	
Graphic Trend 1	[HR] P1 P2 NIBP SpO2 ****Pleth CO2 Resp Temp	
Graphic Trend 2	HR P1 P2 NIBP [SpO2] ****Pleth CO2 Resp Temp	
Recorder Setup		
Start on Alarms	YES [NO]	
Waveform Delay	[12 s] OFF	
Trend Resolution	1 [5] 10 30	
Paper Speed	6.25 12.5 [25]	
Recording Length	[30 s] Cont	
Display Trends		
Parameter	Alternatives [Default selection]	User default
Trend Setup / Trend Page 1		
Field 1	Real-time ECG in all models	
Field 2	OFF ECG [HR] P1 P2 NIBP SpO2 ****Pleth CO2 Resp Temp	
Field 3	OFF ECG HR P1 P2 [NIBP] SpO2 ****Pleth CO2 Resp Temp	
Field 4	OFF ECG HR P1 P2 NIBP [SpO2] ****Pleth CO2 Resp Temp	
Field 5	OFF ECG HR P1 P2 NIBP SpO2 ****Pleth CO2 [Resp] Temp (**CO2, ***CO2)	
Trend Setup / Trend Page 2		
Field 1	Real-time ECG in all models	
Field 2	OFF ECG [HR] P1 P2 NIBP SpO2 ****Pleth CO2 Resp Temp (**SpO2)	
Field 3	OFF ECG HR P1 P2 NIBP [SpO2] ****Pleth CO2 Resp Temp (*P1, **Pleth, ***P1)	
Field 4	OFF ECG HR P1 P2 NIBP SpO2 [****Pleth] CO2 Resp Temp (*P2, **CO2, ***P2)	
Field 5	OFF ECG HR P1 P2 NIBP SpO2 ****Pleth CO2 Resp [Temp] (**Resp)	

Trend Setup / Trend Page 3		
Field 1	Real-time ECG in all models	
Field 2	[OFF] ECG HR P1 P2 NIBP SpO2 ****Pleth CO2 Resp Temp (*HR, **HR, ***SpO2)	
Field 3	[OFF] ECG HR P1 P2 NIBP SpO2 ****Pleth CO2 Resp Temp (*SpO2, **SpO2, ***Pleth)	
Field 4	[OFF] ECG HR P1 P2 NIBP SpO2 ****Pleth CO2 Resp Temp (*Pleth, **Temp, ***CO2)	
Field 5	[OFF] ECG HR P1 P2 NIBP SpO2 ****Pleth CO2 Resp Temp (*Temp, **Resp)	

*) default in models with invasive pressure,

**) default in models with CO₂,

***) default in models with invasive pressure and CO₂

****) not available with the Nellcor option, N-LNSAT

10. TRENDS

The monitor accumulates and displays trend data for user selected periods between 2 and 24 hours.

There are two types of trend screens: graphic trend displays measured data in bars or dots, and numerical trends give the information in tabular form.

In addition a 10-minute trend is displayed in the **Alarm Setup** menu for every parameter with alarm limits.

During trend display, the monitor is active and the numerical information is continuously updated and displayed. Trend data is stored in memory for 15 minutes after the monitor is turned off.

Viewing graphic trends

- Press **Menu**.
- Select **Trends**.
- Select **Graph 2 h, 4 h, 12 h** or **24 h**.

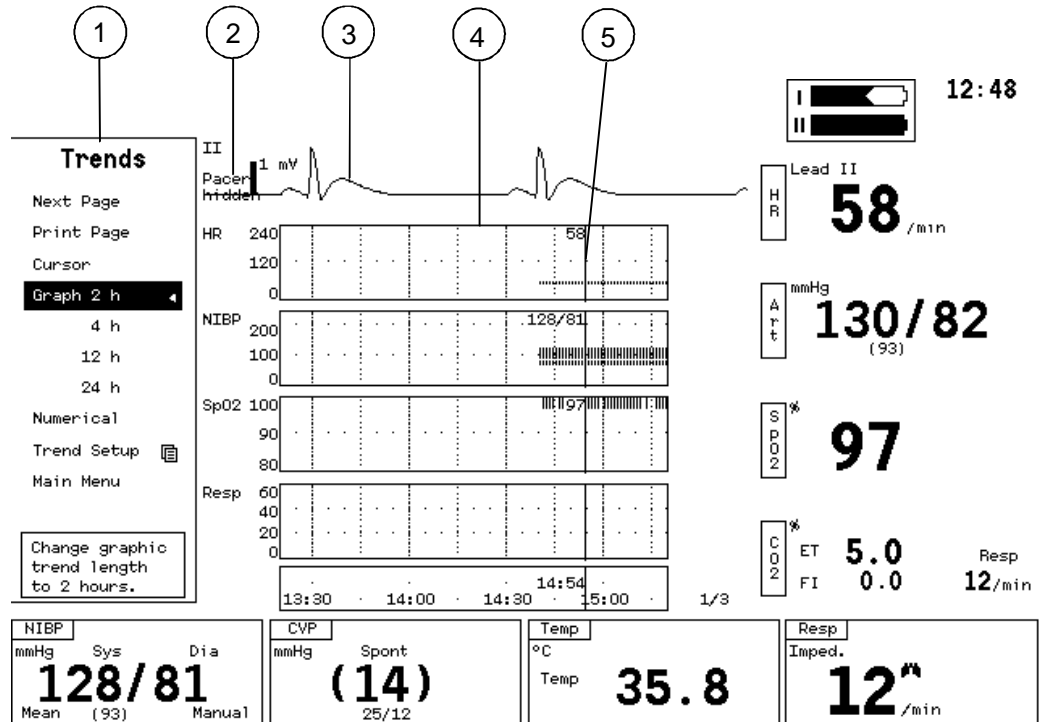

Figure 10-1 Graphic trend

- (1) List of selections
- (2) Labels
- (3) Real time ECG above the trend information
- (4) Parameter trend fields
- (5) Movable trend cursor

Graphic trend pages

There are three pages of graphic trends. Pages are turned by selecting **Next Graph**. The page that is viewed last is stored in memory. It appears first when trends are viewed again.

Table 10-1 The parameters trended in three pages

1st Page			
Basic model	Model with invasive pressure	Model with CO₂	Model with CO₂ and invasive pressure
ECG	ECG	ECG	ECG
HR	HR	HR	HR
NIBP	NIBP	NIBP	NIBP
SpO ₂	SpO ₂	SpO ₂	SpO ₂
Resp	Resp	CO ₂	CO ₂
2nd Page			
Basic model	Model with invasive pressure	Model with CO₂	Model with CO₂ and invasive pressure
ECG	ECG	ECG	ECG
HR	HR	SpO ₂	HR
SpO ₂	P1	Pleth*	P1
Pleth*	P2	CO ₂	P2
Temp	Temp	Resp	Temp
3rd Page			
Basic model	Model with invasive pressure	Model with CO₂	Model with CO₂ and invasive pressure
ECG	ECG	ECG	ECG
Off	HR	HR	SpO ₂
Off	SpO ₂	SpO ₂	Pleth*
Off	Pleth*	Temp	CO ₂
Off	Temp	Off	Resp

*) not available with option N-LNSAT

Parameters displayed on each page can be selected in *Trend Setup*.

Resolution

Resolution of trend display depends on the trend length selected.

Table 10-2 Trend lengths and resolutions

Trend length (hours)	Resolution (minutes)
2	1
4	2
12	6
24	12

Viewing numerical trend

You may view trend data also in numerical format. The trend information is updated every five minutes and always after NIBP measurement. The latest information is displayed at the bottom of the page.

- Select **Numerical**.

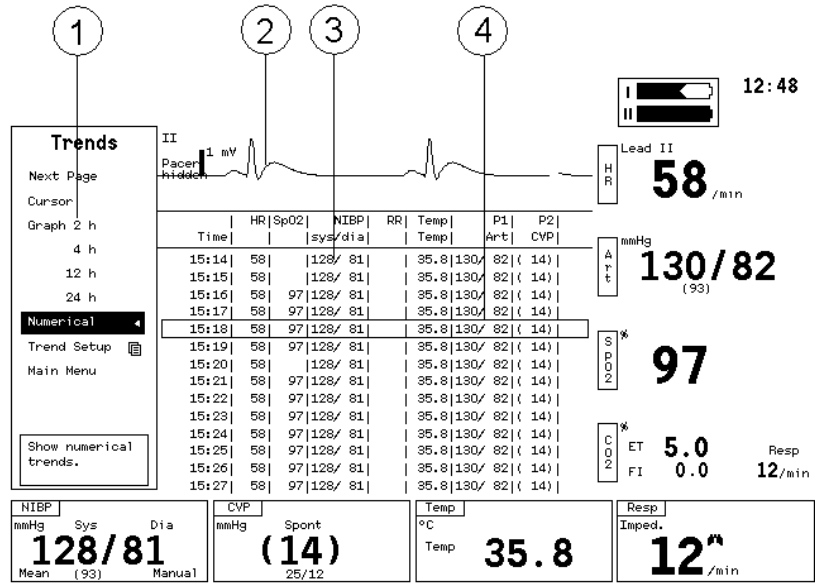

Figure 10-2 Numerical trend page

- (1) List of selections
- (2) Real time ECG above the trend information
- (3) Numeric trend information
- (4) Movable cursor

Parameters displayed are:

HR; SpO₂; NIBP sys/dia; P1/Art sys/dia; P1/CVP mean; CO₂ Et/Fi; RR

Changing trend setup

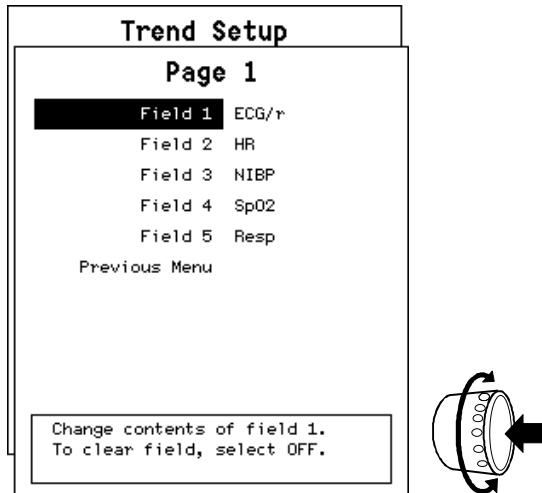

- Select **Trend Setup** in **Trends** menu.
- Select the graphic trend page you want to change.
- Select the parameter for each field, or select **OFF**.

If you want to make your trend setup permanent you can store it, see chapter "Monitor setup/Default settings."

Erasing trend data

- Press **Menu**.
- Go to **Patient Data**.
- Select **Reset Trends**.
- Select **YES** to confirm resetting trends.

11. PATIENT DATA

Patient Data menu is used for identifying the patient case and erasing trends and settings.

To stop a monitoring case, reset trends between patients. Alternatively you can reset all data and settings. If the trends are just being printed, they cannot be erased. A message 'Resetting not possible during printing. Please wait until printing is completed.' appears.

The **Patient Data** menu will open automatically when the monitor is started less than 15 minutes after previous case, and the trends have not been erased. This is to confirm that the collected data is connected to the right patient.

- Press **Menu**.
- Select **Patient Data**.

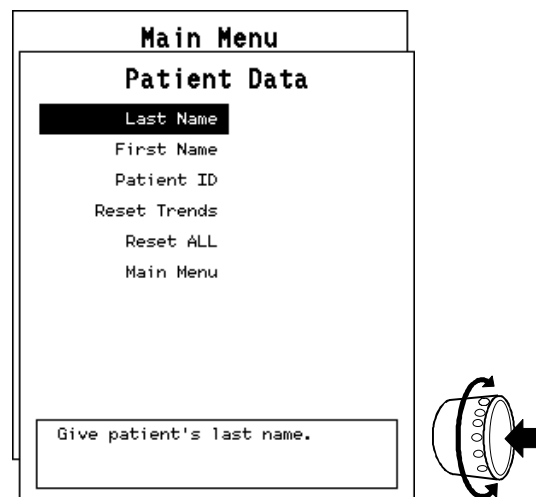

- Last Name** Give patients last name, max. 14 characters, with ComWheel.
- First Name** Give patients first name, max. 14 characters, with ComWheel.
- Patient ID** Give patients ID, max. 14 characters, with ComWheel. This starts the case, the message 'Case started' is displayed.
- Reset Trends** Erase trend memory between patients. Select **YES** to confirm the erasing, the message 'Case ended' is displayed.
- Reset ALL** Return all the settings to their defaults and erase trend and alarm memory. Select **YES** to confirm the erasing, the message 'Case ended' is displayed.
- Main Menu** Return to **Main Menu**.

The **Last Name**, **First Name** and **Patient ID** can be entered also from the Datex-Ohmeda Central via network. The name is displayed as long as there are less than five alarm messages displayed simultaneously.

12. RECORDING AND PRINTING

The optional built-in recorder provides single, dual and triple real time waveform recording, and single and dual recordings of numerical information. In addition it can record up to 24 hours of graphic and numerical trend data.

NOTE: Printings on thermal paper may be destroyed when exposed to light, heat, alcohol etc. Take a photocopy for archives.

Graphical trend data can also be printed on the laser printer either from the local port, or, if the monitor is connected to network, using a central printer.

Recording

- Press **Recorder Start/Stop** to start and stop recording.

NOTE: Scaling of recorded waveforms follows the displayed parameter scaling, when applicable.

Selecting the waveforms to be recorded

- Select up to three waveforms you wish to record in **Menu - Record/Print - Wave Setup** menu.

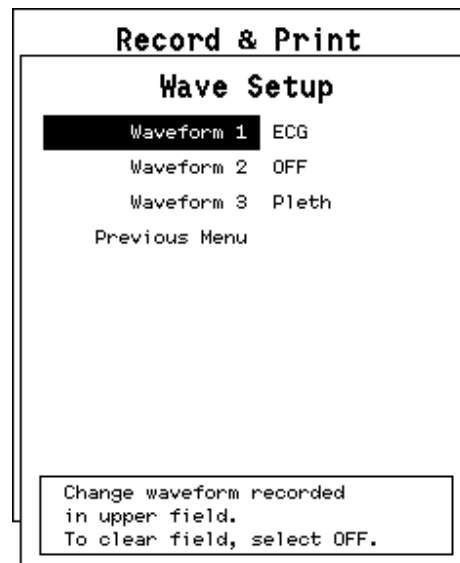

Waveform x Select the recorded waveforms.



Recording trends

- Press **Menu** and select **Record/Print**.
- Start recording by selecting **Record Graph. Trend**, or **Record Num. Trend**, or **Record Tab. Trend**.
- Stop printing by selecting **Stop Graph./Num./Tab. Trend**.

To select the graphical trend you want to record, go to **Menu - Record/Print - Graph - Trend Setup**.

Other recorder settings

To make the following selections, go to **Menu - Record/Print - Recorder Setup**:

Start on Alarms Select if an alarm activates the recorder or not (**YES / NO**).

Recording time is 30 seconds: 12 seconds recording from the recorder memory, 18 seconds real time recording.

Alarm source annotated.

Waveform Delay Select the amount of waveform data (in seconds) that will be stored in the recorder memory and printed before real-time waveform. The choices are: **OFF** or **12 seconds**.

Paper Speed Select the paper speed **6.25**, **12.5**, or **25** mm/seconds.

Recording Length

Select the printing time, either 30 seconds or continuous.

Previous Menu Return to **Record&Print** menu.

Recorder paper replacement

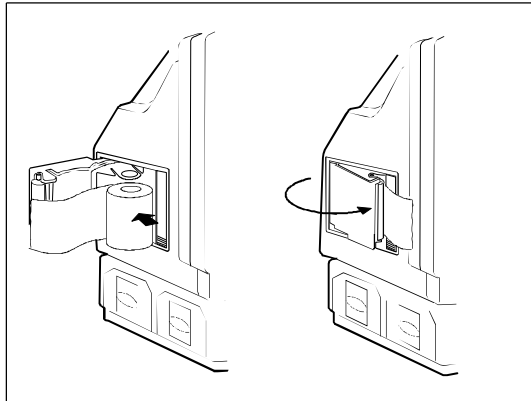

Figure 12-1 Placing paper roll

Printing

Graphical trend pages P1, P2, and P3 can be printed either separately or all together. Print with a local laser printer, or if the monitor is connected to the network, with a central laser printer.

To print:

- Press **Menu**.
 - Select **Record/Print**.
 - Select **Print Graphical**.
 - Select **Print Graphs**.
- or
- Press **Menu**.
 - Select **Trends**.
 - Select **Print Page**.

Selecting the printer

- Press **Menu**.
- Select **Record/Print**.
- Select **Print Graphical**.



- Select **Printer Location**.
- Select **Local** for local printing or an appropriate network alternative. Network printers are named in your Datex-Ohmeda Central.

Selecting the paper size

- Press **Menu**.
- Select **Record/Print**.
- Select **Print Graphical**.
- Select **Printer Paper Size** and the right one of **A4** or **Letter** size.

Printer installation

A laser printer can be connected to the monitor's serial connector and used as the local printer. The printer must be able to use PCL5, and a special converter cable (p/n 894193) is required when using the parallel connection. The printers with serial connection can be connected directly to the monitor with a standard cable.

Purchase the printer locally. The printer memory should be at least 2 MB.

WARNING **ELECTRIC SHOCK HAZARD: The printer must be supplied from an appropriate extra separating transformer.**

WARNING **ELECTRIC SHOCK HAZARD: Before starting to use the system, ensure that the entire combination complies with the international standard IEC 60601-1-1 and with the requirements of the local authorities.**

Printer setup

For instructions refer to the printer's documentation. Make sure that the printer settings are set to serial interface.

13. NETWORK AND DATACARD

The monitor can be equipped with following options to enhance data continuum capabilities in the Datex-Ohmeda S/5 information system:

N-LNET	Network
N-LDATA	DataCard
N-LDNET	DataCard and network.

Networking

If the monitor is connected to the network, the symbol is displayed:



When the monitor is connected to network

- Time and date are set by the network and cannot be adjusted in the monitor.
- The patients name can be entered in the **Patient Data** menu to be displayed on the Datex-Ohmeda Central's and the monitor's screen and printed on the laser printouts.
- Measured and entered patient data can be viewed on the Datex-Ohmeda Central.
- Measured patient data and alarms can be viewed on other Datex-Ohmeda S/5 monitoring systems, but not vice versa.

Patient view and multi view on the Datex-Ohmeda Central screen

The Patient View on the Datex-Ohmeda Central screen looks like monitor's own screen.

In the Multi View, the measured values from each of the monitor shown on the screen are:

8-Patient mode	16-Patient mode
ECG waveform	ECG waveform
HR, P1, SpO ₂ , RR or EtCO ₂ numbers	HR numbers
Alarm field	Alarm field

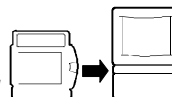

Monitor-to-Monitor communication

When the monitor is viewed on another S/5 monitor, the following parameters are displayed:

Waveforms	EGC, Pleth, Art, CO ₂
Numbers	HR, SpO ₂ , Art, CO ₂
1-hour numerical trend	HR, SpO ₂ , NIBP, P1, P2, CO ₂

You cannot view other monitors on the S/5 Light Monitor.

DataCard

The DataCard is a rewritable flash memory card. With the DataCard, the patient trend data collected with the S/5 Light Monitor can be transferred to other S/5 monitors with record keeping or intensive care softwares, as well as to S/5 monitors with ARK software and S/5 monitors.

Data from any card cannot be loaded to the S/5 Light Monitor, nor loaded from the network to the S/5 Light Monitor or vice versa.

Inserting and removing the card

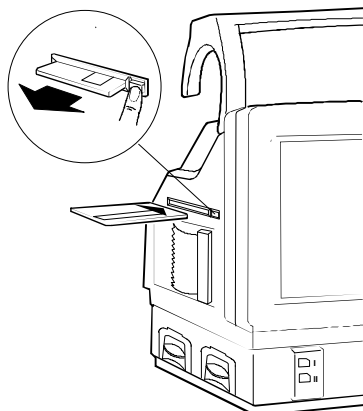

- Push the card into the slot on the left side panel of the monitor.



When the DataCard is inserted, this symbol is displayed. If the symbol is blinking, the card is not inserted properly.

If any other card or a faulty card is inserted, a message 'Faulty DataCard - change card' is displayed.

To remove the card:

- Push the lever on the side of the slot.

Collecting data

When the card is inserted, the continuous patient trend data is automatically stored on it. When the card is filled, the oldest data is erased, but only if it is older than two days. You can retrieve information of approximately the last 24 hours. The memory capacity depends on the complexity of the saved data.

14. ECG





ECG monitoring is used to: measure the heart rate, detect arrhythmias, monitor pacemaker function, and myocardial ischaemia.

ECG reflects the electrical activity generated by the heart muscle.

You can use 5- and 3-lead sets and trunk cables, but only leads I, II, or III can be measured.

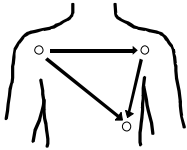
Monitoring ECG

1.	Connect the patient cable to the blue ECG connector on the monitor's side panel.
	Place the electrodes on the patient. Connect the leadwires to the electrodes. NOTE: Always attach all the electrodes to the patient, also when using a 5-lead cable.
	The label of the lead is displayed in the ECG field and above the HR numerics.

Applying electrodes

WARNING

PATIENT SAFETY:

Ensure proper contact of the electrosurgery return electrode to avoid possible burns on the patient via ECG electrodes and probes.

Make sure that no part of the patient connections touches any electrically conductive material, including earth.

Patient preparation

- Ensure good skin contact with the electrodes. Remove excessive body hair, skin oil etc.
- Check, that the pre-gelled electrodes are moist and have not dried out during storage.

Placing electrodes

Avoid bones close to the skin, obvious layers of fat and major muscles.

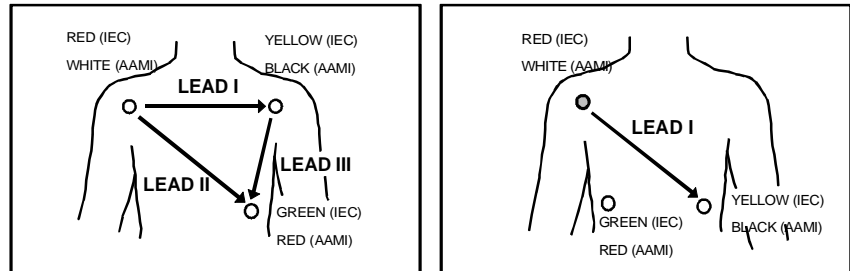

Figure 14-1 Lead selections in typical electrode positioning

Left: Standard 3-Lead Positioning

Middle: Modified CB₅ 3-Lead Positioning

Right: Standard 5-Lead Positioning, place the fifth electrode in one of the six places indicated.

Electrode coding

Table 14-1 IEC and AAMI codes for ECG electrodes

3-LEAD IEC STANDARD	5-LEAD IEC STANDARD
L = yellow (left arm) F = green (foot) R = red (right arm)	R = red (right arm) N = black (neutral) L = yellow (left arm) F = green (foot) C = white (chest)
3-LEAD AAMI STANDARD	5-LEAD AAMI STANDARD
LA = black LL = red RA = white	RA = white RL = green LA = black LL = red V = brown

Selecting trunk cable

Use a 5-lead set with a 5-lead trunk cable, and accordingly a 3-lead set with 3-lead trunk cable. (If you have a 3-lead set connected to a 5-lead trunk cable, you must set in the **ECG Setup** menu the selection **5 Lead Cable to 3select**).

What should happen when electrodes are applied ?

- ECG display appears.
- A beep is heard when a QRS complex is detected.

Selecting ECG lead

- Press the **Menu** key and select **ECG & Resp**.
- Select **ECG Lead**.
- Select one of **I, II, or III**.

NOTE: Only 3 leads are measured, though a 5-lead set and cable are used.

NOTE: To minimize the interference from the electrosurgery unit (ESU), place the electrodes and select the lead so that the current from the surgical burning area to the return electrode does not go through the measured ECG lead.

ECG display

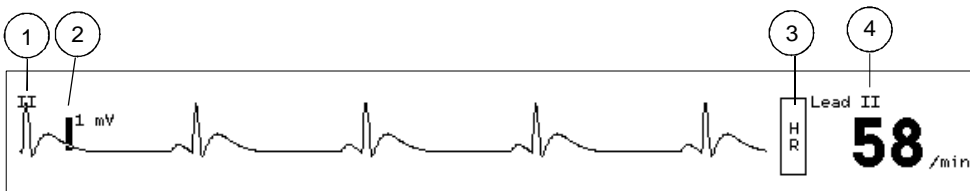

Figure 14-2 Display of ECG and HR

- (1) Selected lead label
- (2) 1 mV reference bar
- (3) Heart rate (HR) label
- (4) Heart rate calculation source and message field for HR messages

Cascaded ECG

If two fields are configured (See "Monitor setup/Waveform fields") for ECG display the waveform continues from one field to another. Thus more QRS complexes are displayed at the same time.

ECG adjustments

- Press the **Menu** key.
- Select **ECG & Resp.**

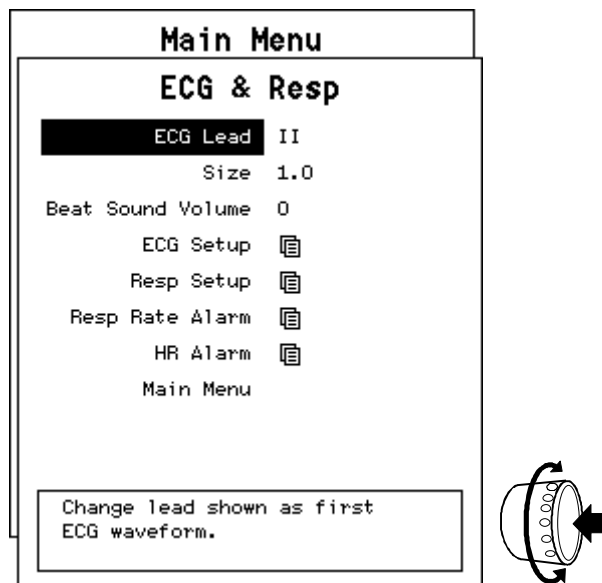

ECG Lead

Select the displayed lead: *I*, *II*, or *III*.

Size

Adjust from 0.2 to 5 in steps of 0.1.

The bar on the left side of the ECG display is 1 mV.

Beat Sound Volume

A beat (QRS complex, or a plethysmographic or pressure pulse) produces a beep, and its volume is adjustable from 0 to 10 in steps of 1. Adjusting also changes the beat sound volume of SpO₂.

(When SpO₂ is monitored, the tone of the pulse beep rises with increasing oxygen saturation and falls as saturation decreases.)

ECG Setup

Opens a submenu for ECG settings, see below.

HR Alarm

Opens a submenu for adjusting heart rate alarm, see chapter "Alarms."

Resp Setup

Opens a submenu for Respiration settings, see chapter "Respiration."

Resp Rate Alarm

Opens a submenu for adjusting respiration rate alarm, see chapter "Alarms."

ECG setup

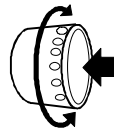
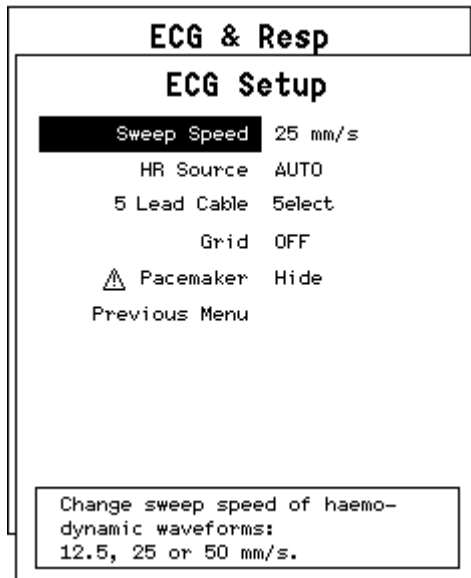

Sweep Speed Set the speed of the waveform sweep. Speeds are: **12.5**, **25**, and **50** mm/s on a 9" screen.

The 12.5 mm/sec speed is suggested for monitoring patients with a slow HR to show more QRS complexes per sweep.

The 50 mm/sec speed is recommended when monitoring patients with a high HR or when using cascaded ECG.

NOTE: The sweep speed is same for ECG, plethysmographic, and invasive pressure waveforms.

HR Source Select the heart rate source. If ECG signal is too noisy for reliable heart rate calculation, heart rate can be calculated from pressure (**Art**) or pulse oximetry (**Pleth**). The heart rate source appears above the numerical display of the heart rate.

The **AUTO** selects the first available of ECG, Art, and Pleth.

5 Lead Cable If you use a 5-lead trunk cable with a 3-lead set, select **Select** on, otherwise the 'Leads Off' message will be displayed.

Grid Select **ON** to display ECG waveform with 0.5 mV grid lines.

Pacemaker Selects how to display the pacing pulse of a cardiac pacemaker, **Show**, **Hide** or **ON R**.

Hide: The pacing pulse is filtered from the waveform.

Show: As above, but the pulse is marked with a constant height marker.

ON R: Pacing pulses are not filtered from the waveform. This improves ECG monitoring with A-V pacemaker patients, as the QRS complexes are counted even if the pacing pulse hits the complex. On the other hand, during asystole the monitor may count pacing pulses as heart rate.

Setting heart rate alarm

Heart rate alarms can be adjusted in the **Alarms Setup** menu or accessed through the **ECG & Resp.** menu. See more detailed instructions in the “Alarms” chapter.

Alarm messages are explained in chapter “Maintenance and troubleshooting; Alarm and information messages.”

Pacemaker patients

The monitor detects and rejects pacemaker pulses, see selection **Pacemaker** in the **ECG Setup** menu. Sometimes this may lead to unnecessary asystole alarms. The pacemaker may well change the shape of QRS so much that QRS detection may be affected.

WARNING **PATIENT SAFETY: Monitor may count pacemaker pulses as heart rate during cardiac arrest, some arrhythmias, or with certain types of pacemakers, particularly in ON R mode. Do not rely entirely upon alarms. Keep pacemaker patients under close surveillance.**

15. RESPIRATION



Respiration measurement uses ECG electrodes to measure the impedance changes caused by breathing.

The measurement is intended for patients three years old and up.

WARNING

PACEMAKER PATIENTS: The impedance respiration measurement may cause rate changes in Minute Ventilation Rate Responsive Pacemakers. Set the pacemaker rate responsive mode off or turn off the impedance respiration measurement on the monitor.

Monitoring respiration

Respiration measurement is activated when a digit or waveform field is selected for it:

- Press the **Menu** key.
- Select **Monitor Setup**.
- Select **Waveform Fields** or **Digit Fields**.
- Select **Resp.** to be displayed on an appropriate field.

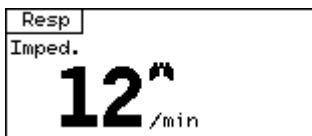

Figure 15-1 Respiration display

Patient connections

Respiration uses the same electrodes as ECG, refer to the "ECG" section of this manual.

Respiration setup

- Press the **Menu** key.
- Select **ECG & Resp.**

- Select **Resp Setup**.

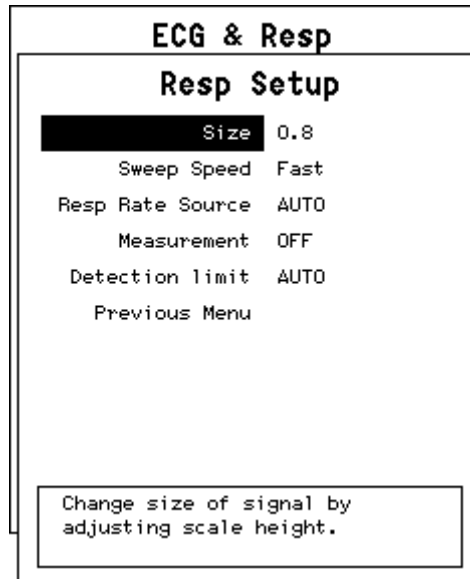

Size Adjust the scale height 1...50 mm/Ohm. The bar on the left displays always 1 Ohm.

Sweep Speed Set the speed of the waveform sweep. Speeds are: **Fast** 6.25 and **Slow** 0.625 mm/s on a 9" screen.

Resp. Rate Source Select the respiration rate source of **AUTO**, **CO₂** and **Imped**. The **AUTO** sets the CO₂ first, and if it is not available, impedance respiration is used. Default selection is **AUTO**.

Measurement Select **ON** to measure impedance respiration and **OFF** to set the measurement off. Default selection is **ON**.

Detection Limit Adjusts measurement sensitivity. Selections are **AUTO**, **20%**, **40%**, **60%**, or **100%**. The percentage is the ratio to the 1 Ohm reference bar which is 100%.

Limitations of measuring

Movement artifacts

Changing the patient position, moving the head, moving the arms or shaking will result in movement artifacts. Also the heart may cause noticeable movement, and sometimes this may interfere with the respiration measurement.

Electrical interference

Electrical devices that emit electromagnetic disturbance will result in artifacts or disable the respiration measurement completely. Such devices are electrosurgery units and infrared heaters, among others.

Intermittent mechanical ventilation

During spontaneous breathing the ventilator may at times support the patient's ventilation with an extra inspiration. If these ventilator inspirations are substantially larger than the spontaneous breaths, the respiration calculation may mistakenly count only the ventilator produced inspirations and expirations. You can correct this by manually adjusting the detection limits.

1. Press the **Menu** key.
2. Select **ECG & Resp.**
3. Select **Resp Setup.**
4. Select **Detection limit.**

Measuring principle

ECG electrodes are used to measure impedance change across the thorax. Impedance change is caused by movements and changing air volume in the lungs.

Lead selection using 3-lead cables	Signal fed between electrodes	Signal measured
I	L and R	F*
II	F* and R	L
III	F* and L	R
Using 5-lead cables	L and F	N

*) may be neutral (N) in some older 3-lead sets.

16. PULSE OXIMETRY





Pulse oximetry is used for monitoring oxygen saturation (SpO_2), pulse rate, and plethysmographic waveform.

The plethysmographic pulse waveform reflects the changes in blood pulsation at the measuring site. The amplitude of the waveform reflects the strength of perfusion, except when using the Nellcor option, N-LNSAT.

Pulse oximetry is measured with a sensor from finger, toe, ear, or with little children, from palm or feet.

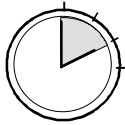
Monitoring pulse oximetry

1.		Attach the sensor to the gray connector on the monitor's side panel.
2.		Attach the sensor to the patient. The SpO_2 and pulse rate values, and the plethysmographic pulsewave appear on the screen.
3.		Change the sensor site frequently.
4.		Remove the sensor from the patient and clean it.

Selecting sensor

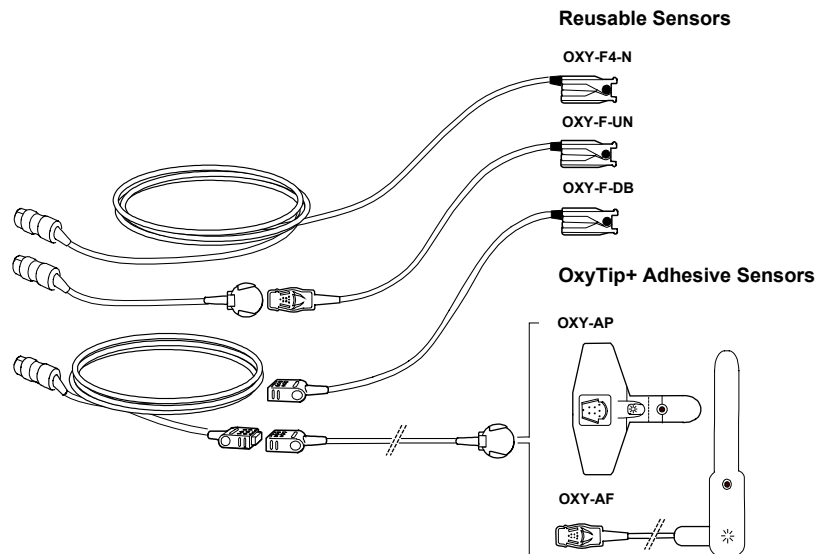

Figure 16-1 Sat Sensors for different applications

NOTE: These sensors cannot be used when using the Nellcor option, N-LNSAT. Please refer to chapter “*Alternative SpO₂ measurement.*”

Applying sensors

- Use dry and clean sensors only.
- Confirm that red light lights up in the sensor when it is connected to the monitor.
- Clean the application site.
Remove nail polish, artificial fingernail, earrings etc.
Clip long finger nails.
- Attach the sensor cable to the wrist or bed clothes to prevent cable and sensor from moving.

WARNING PATIENT SAFETY: Change measuring site frequently.

- Change sensor site and check skin and circulatory status every 2-4 hours with adults, and every hour with little children.

What should happen when sensor is applied ?

- The message 'Pulse Search' appears.
- When 'Pulse Search' is completed, the pulse rate and SpO₂ value will appear.
- The plethysmographic waveform will appear. The waveform scale is established according to the measured amplitude.
- Pulse beep is heard. The tone of the pulse beep will rise with increasing oxygen saturation and fall as saturation decreases.

Pulse oximetry display

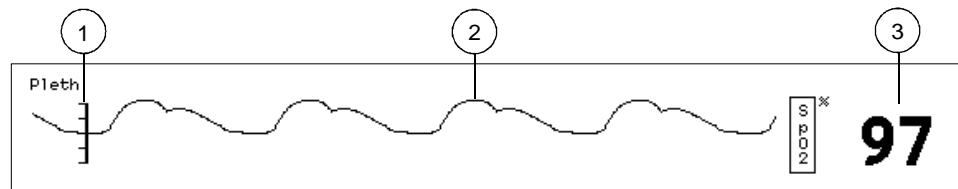

Figure 16-2 Plethysmographic waveform with oxygen saturation number

- (1) Bar reflecting the signal amplitude, not available with the Nellcor option, N-LNSAT
- (2) Plethysmographic waveform
- (3) Oxygen saturation (SpO₂)

Measuring limitations

Plethysmograph

The waveform is a good indicator of measurement validity. If the wave is noisy, amplitude is low, or the normal waveform cannot be seen, attach the sensor again.

Dyshemoglobins

The pulse oximeter cannot distinguish between oxyhemoglobin and dyshemoglobins. Thus, the SpO₂ values may be erroneously high in smokers or in patients who have burns or carbon monoxide (CO) intoxication.

Electrosurgery

Under some circumstances electrosurgery may cause noise on the display. Therefore, be careful in interpreting the results, especially the plethysmographic pulse waveform, during electrosurgery.

External interference

Ambient light, intravascular dyes and vasoconstrictive drugs may affect the accuracy of the measurement. Improper sensor attachment (measuring site too thick or thin, sensor ends not aligned), or patient movement may also interfere with the measurement.

Adjustments

- Press the **Menu** key.
- Select **SpO2 & Temp**.
- Select and adjust by turning and pressing the ComWheel.

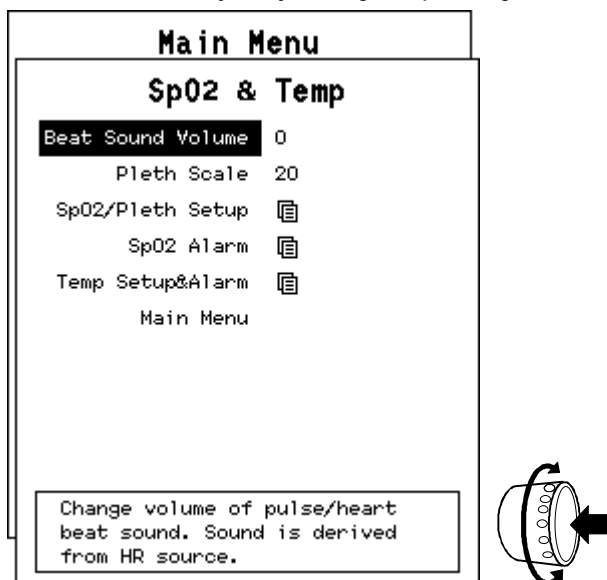

Beat Sound Volume

Adjust beat volume from 0 to 10.

Scale

Select Scale from **50, 20, 10, 5, 2** or use **AUTO** which automatically adjusts the scale according to the measured waveform.

NOTE: The selection is not available with the Nellcor option, N-LNSAT.

Sweep Speed

Set the speed of the display sweep for the waveform display. The speeds are **12.5, 25, or 50** mm/sec on a 9" screen.

NOTE: The sweep speed is same for ECG, plethysmographic, and invasive pressure waveforms.

- HR Source** Select the heart rate source. If ECG signal is too noisy for reliable heart rate calculation, heart rate can be calculated from pressure (**Art**) or pulse oximetry (**Pleth**). The heart rate source appears above the numerical display of the heart rate.
- The **AUTO** (default) selects the source in the following order: ECG, pressure, and plethysmographic pulse waveform.
- SpO₂ Response** Select how fast the SpO₂ value follows the measurement. The selections are: **Beat-to-beat**, **Normal** (10 s), or **Slow** (20 s, default setting). The selections with the Nellcor option, N-LNSAT, are **Fast**, **Normal**, and **Slow**.
- SpO₂ Alarms** Opens a submenu for adjusting alarms, see the "Alarms" chapter.
- Temp Setup** Opens a submenu for adjusting temperature settings, see the "Temperature" chapter.
- Main Menu** Return to **Main Menu**.

Setting SpO₂ alarms

The alarms can be adjusted in the **Alarms Setup** menu, accessed through the **SpO₂ & Temp** menu. See more detailed instructions in the chapter "Alarms."

Alarm messages are explained in the chapter "Maintenance and troubleshooting; Alarm and information messages."

Measuring principle

Oxygen saturation, SpO₂, expressed as a percent, defines the amount of oxygen carried compared to total capacity (also called functional or *in vivo* oxygen saturation). It is measured by a two wavelength pulse oximeter.

The SpO₂ value is measured by light absorption technique. Red and infrared light (660 nm and 910 nm) is emitted from the light source. The amount of transmitted light is detected in the detector half. When the pulsative part of the light signal is examined, the amount of light absorbed by arterial hemoglobins is resulted, and the saturation level can be calculated.

The saturation percentage is displayed numerically, and the pulse beep sound varies according to the saturation level.

Plethysmographic pulse wave

The plethysmographic pulse wave is derived from variations of the intensity of the transmitted light and reflects the blood pulsation at the measuring site.

Pulse rate

Pulse rate is calculated from the plethysmographic pulse wave.

Alternative SpO₂ measurement

As an alternative to the Datex-Ohmeda pulse oximetry, the monitor can be equipped with the Nellcor compatible saturation option, N-LNSAT. With this option you can use the sensors listed below.

NOTE: When the monitor has the N-LNSAT option, the monitor is equipped with the Nellcor measurement only and cannot use Datex-Ohmeda Sat Sensors.

Plethysmographic scale

You cannot adjust the scaling when using the N-LNSAT option; it is automatically set by the monitor.

Nellcor® sensors

Use one of the following Nellcor sensors with the N-LNSAT module:

OXISENSOR II Oxygen transducer	
D-25, D-25L	Adult
D-20	Pediatric
I-20	Infant
N-25	Neonatal/Adult
R-15	Adult Nasal
OXICLIC Oxygen transducer	
A	Adult
P	Pediatric
DURASENSOR Oxygen transducer	
DS-100A	Adult
DURA-Y Oxygen transducer	
D-YS	Adult/Pediatric/Infant/Neonatal
OXIBAND Oxygen transducer	
OXI-A/N	Adult/Neonatal
OXI-P/I	Pediatric/Infant

17. TEMPERATURE



One temperature value can be measured from various sites using YSI-400 probes, or equivalents.

Monitoring temperature

- Attach the probe to the patient.
- Connect the temperature probe to the connector on the right side of the monitor.
- The measured value appears on the digit field.

Temperature display

Example:

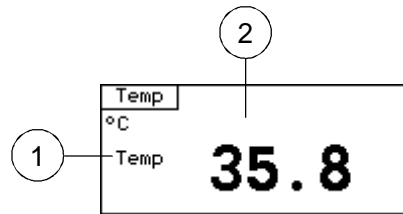

Figure 17-1 Temperature display

- (1) Label
- (2) Temperature value

Temperature testing

The monitor automatically tests the temperature measuring function at the start-up and after that every 10 minutes. If the test fails contact your local service representative.

Temperature setup

- Press **Menu**.
- Select **SpO2 & Temp**.
- Select **Temp Setup&Alarm**.

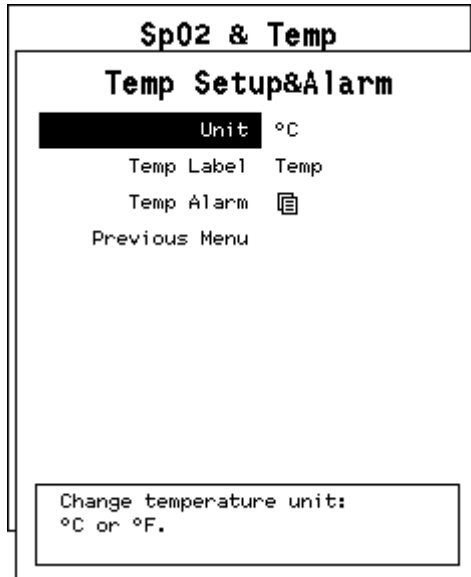

Unit Selects unit, °C or °F.

Temp Label Select the label:

AirW	airway temperature
Axil	axillary temperature
Blad	bladder temperature
Eso	esophageal temperature
Myo	myocardial temperature
Naso	nasopharyngeal temperature
Rect	rectal temperature
Room	room temperature
Skin	skin temperature
Temp	temperature
Tymp	tympanic temperature
Core	central temperature
Surf	surface temperature

Previous Menu Return to **SpO2 & Temp** menu.

18. NON-INVASIVE BLOOD PRESSURE (NIBP)



The monitor can measure NIBP automatically after set intervals, or take single measurements, or measure continuously for five minutes in STAT mode.

WARNING **PATIENT SAFETY: The monitor sets the inflation pressure according to the first measurement. Reset the monitor between patients to reset the inflation limit.**

CAUTION Vibrations during transport may disturb the NIBP measurement.

Monitoring NIBP

- Select the appropriate cuff and hose.

Table 18-1 NIBP cuff sizes

Cuff	Color	Width		Limb circumference		Hose
		cm	inch	cm	inch	
Large adult	Red	15	6	33 - 47	13 - 18	Black
Standard adult	Blue	12	4.7	25 - 35	9 - 14	Black
Small adult	Gray	9	3.5	18 - 26	7 - 10	Black
Child	Green	6	2.4	10 - 19	4 - 7	Black
Infant	Tan	5.1	2	9 - 14	3 - 5	White
Disposable infant cuff #5		5.5	2.2	10 - 14	4 - 6	White

NOTE: Always use the white hose when measuring little children. Make also sure the **Inflation Limits** selection is set to **150** mmHg or **Auto**.

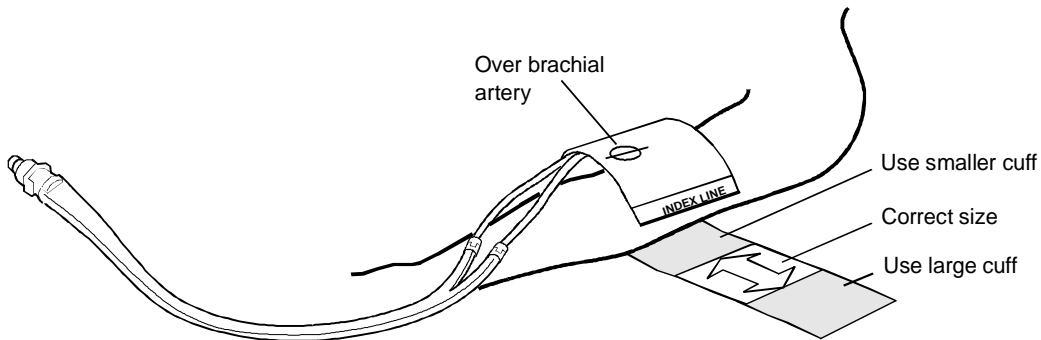
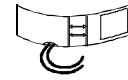

- Attach the cuff to the patient and the hose to the NIBP connector located on the right side panel of the monitor.
- Make sure that NIBP tubes are not bent, pressed or stretched. Measurement may be impaired.
- Press the **NIBP** key to open the NIBP mini menu.
- Select **Start Cycling** or **Start Manual** and press the ComWheel.
- You can also adjust the cycling time by selecting **Set Cycle Time**. Adjust the time by turning and pressing the ComWheel.
- Observe the cuffed limb frequently. The measurement may impair blood circulation.

Display of NIBP measurement

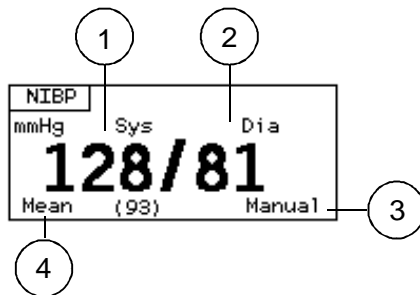

- (1) Systolic pressure
- (2) Diastolic pressure
- (3) Field shows the selected measurement (Manual, STAT), or the time since last autcycle measurement

(4) Mean pressure value of non-invasive blood pressure

At the beginning of the measurement the cuff pressure is displayed in the mean pressure value field.

If motion artifacts are detected, the monitor automatically retains deflation until the motion stops (maximum of 30 seconds). If the artifacts interrupt proper measurement, a new measurement is automatically activated.

When the measurement is ready, a short beep is heard and the result starts flashing.

Automatic NIBP double check

If the NIBP value exceeds the alarm limits, a new measurement is taken automatically (immediately, with MANUAL measurements, and after 30 seconds, with AUTO measurements). If an alarm situation persists, an alarm signal is given out.

Using NIBP functions

To use NIBP functions:

- Press the **NIBP** key to open the NIBP mini menu

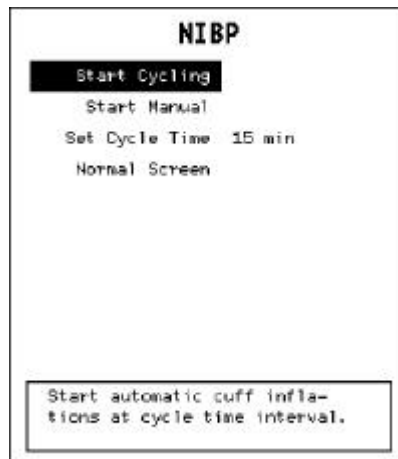

or

- Press **Menu** and select **NIBP & Inv. Press** to open the **NIBP & Inv. Pressure** menu.

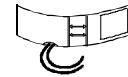

Starting/Stopping Autocycle, Starting a Manual Measurement and Canceling Any Measurement are available through both menus. STAT mode and Venous Stasis are available through the **NIBP & Inv. Pressure** menu only.

Starting/Stopping autocycle

- Select **Start Cycling/ Stop Cycling** to start/stop automatic NIBP measurement at selected intervals.

The bar at the bottom of the NIBP display shows the time remaining to the next measurement.

Autocycling is synchronized to actual time so that if the first measurement happens at 12.02, the next measurement is done at 12.05 and again at 12.10 (5 min intervals).

Starting a manual measurement

- Select **Start/Stop Manual**.

Canceling any measurement

- Press the **NIBP** key,
or
- select the corresponding menu item.

Starting a continuous measurement (STAT)

You can start the continuous measurement for five minutes (STAT mode) through the **NIBP & Inv. Pressure** menu only.

In STAT mode the early systolic value is measured and displayed until the final result is available.

After five minutes the monitor automatically returns to the previously selected cycling interval or to manual mode.

To start the measurement:

- Press the **Menu** key and select **NIBP & Inv. Press.**
- Select **Start STAT.**

Using venous stasis

You can hold a constant pressure in the cuff to help venous cannulation (Venous Stasis). This function is only available through the **NIBP & Inv. Pressure** menu. The pressure is maintained in the cuff for a certain time according to the inflation limits.

Table 18-2 Inflation limits and venous stasis times

Inflation limit	Venous stasis pressure	Venous stasis time
150 mmHg	40 mmHg	1 min
200 mmHg	60 mmHg	2 min
280 mmHg	80 mmHg	2 min

The pressurization time is displayed in the NIBP field and during the last 15 seconds the word 'STASIS' is flashed.

- Press the **Menu** key.
- Select **NIBP & Inv. Press.** and **Start Ven. Stasis.**

To release the pressure before the time is expired:

- Press the **NIBP** key.

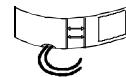

NIBP adjustments

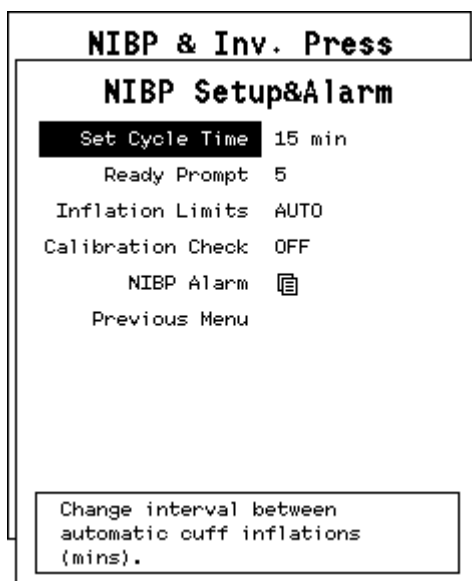

Set Cycle Time Select desired interval time of **1, 2.5, 3, 5, 10, 15, 30,** or **60** minutes.

Ready Prompt Vol.

Adjust the volume of the beep that informs when the NIBP measurement is ready. The range is from 1 (soft) to 10 (loud), or 0 (OFF).

Inflation Limits Select the inflation pressure limit: **280, 200,** or **150** mmHg.

Calibration Check

Start the pressure calibration check with an external manometer. See instructions below.

NIBP Alarm Opens a submenu for adjusting the NIBP alarms, see the “Alarms” chapter.

Previous Menu Return to the **NIBP & Inv. Pressure** menu.

Calibration check

- Remove the cuff from the connector before entering the menu.
- Select **Calibration Check ON** in **NIBP Setup** menu.
- When the calibration menu appears, attach an external manometer with pump to the connector.
- Pump ca. 200 mmHg and compare the readings of the manometer and display. If the difference is greater than 4 mmHg, the calibration must be checked by an authorized service person.

NIBP alarms

NIBP Alarms are set in the **Alarm Setup** menu, see the “Alarms” chapter. The alarm messages are explained in chapter “Maintenance and troubleshooting.”

Measuring principle

The non-invasive blood pressure (NIBP) measurement uses the oscillometric measuring principle. The cuff is inflated with a pressure slightly higher than the presumed systolic pressure, then slowly deflated at a speed based on the patient's heart rate, collecting data from the oscillations produced by the pulsating artery. Based on this data, the unit calculates values for systolic, mean and diastolic pressures.

19. INVASIVE BLOOD PRESSURE



Two invasive blood pressures can be measured with the model F-LMP1.

WARNING

PATIENT SAFETY:

All invasive procedures involve patient risks. Use the aseptic technique. Follow catheter manufacturer's instructions.

WARNING

Ensure proper contact of the return electrode of the electrosurgery unit to your patient to avoid possible burns at sensor sites.

WARNING

Make sure that no part of the patient connections touches any electrically conductive material including earth.

WARNING

Use only defibrillator proof transducers and cables.

Monitoring invasive pressures

Preparing pressure line

- Prepare the transducer kit according to transducer manufacturer's instructions. Ensure there is no air in the line.
- Connect the kit to the transducer cable and the cable to the red connector in the monitor.
- Mount the transducer kit at heart level.
- Connect the patient catheter to the pressure line.
- Zero the transducer.
- Open the line to the patient.

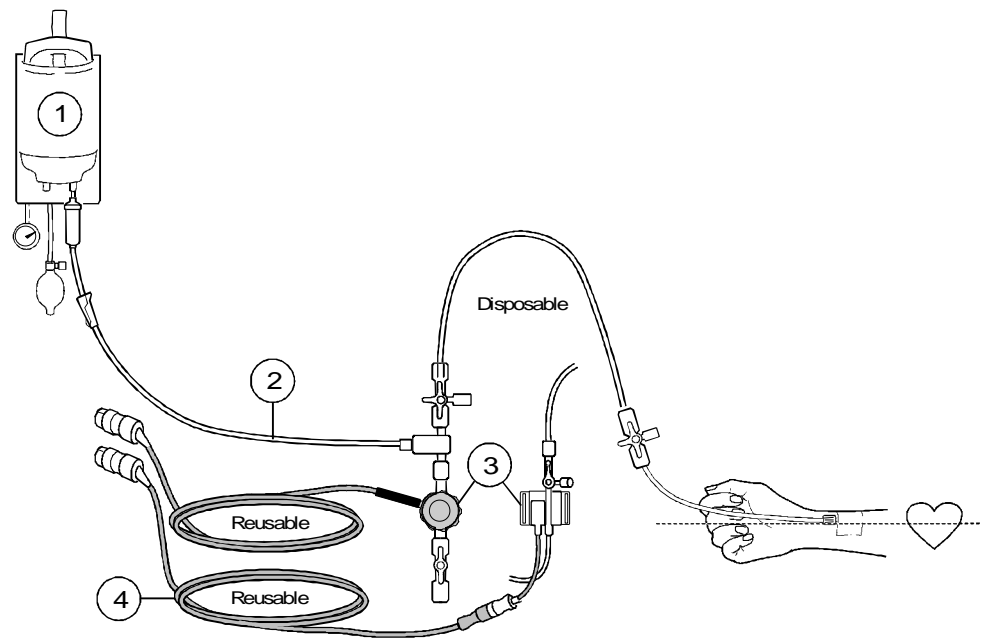

Figure 19-1 Invasive pressure setup for disposable and reusable transducers

- (1) Heparinized fluid bag with pressure infusor
- (2) Flushing set
- (3) Transducer
- (4) Adapter cable for using disposable transducers

Zeroing transducer

Always zero the pressure transducer before monitoring and check zero level after power interruptions.

To zero the transducer:

- Open the transducer to air.
- Press the **Zero ALL** key,
or
select **Zero Px** in the **NIBP & Inv. Pressure** menu.

The messages 'Zeroing' and 'Zeroed' are displayed accordingly. After the channel is zeroed, the zeroing time appears in the menu. If the zeroing fails, the previous zero is used.

- Open the transducer to the patient.

NOTE: ICP can be zeroed via the **NIBP & Inv. Pressure** menu only.

CAUTION Mechanical shock to pressure transducer may change zero balance and calibration.

Invasive pressure display

After the line is zeroed and opened to the patient, the pressure wave appears.

If two pressures are measured they can be combined with individual scales. (Select separate or combined waveforms in the **Monitor Setup/ Waveform Fields** menu, see chapter "Monitor setup").

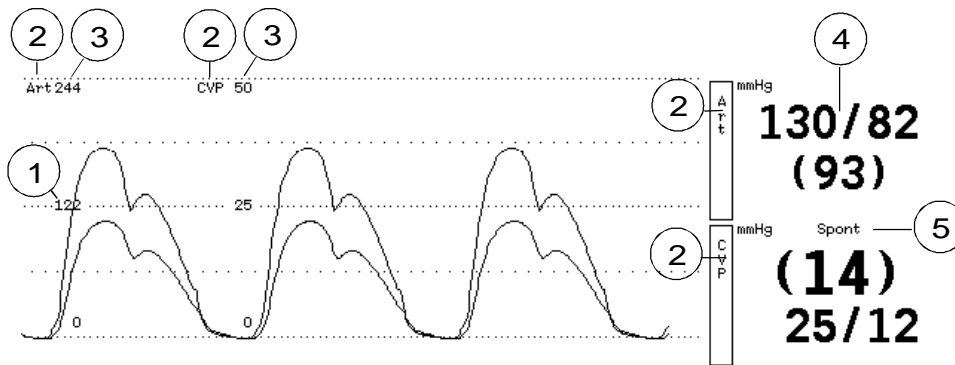
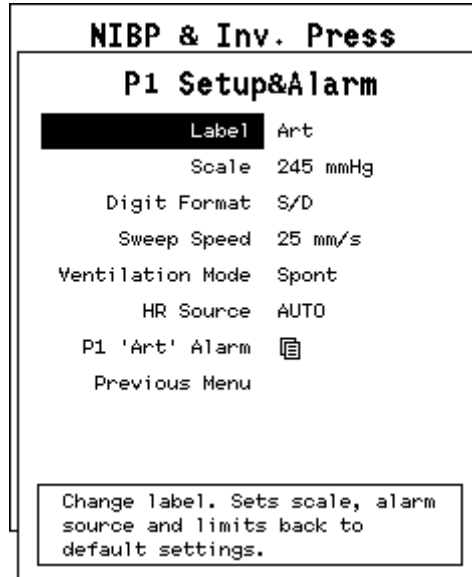

Figure 19-2 Combined pressure waveforms

- (1) Invasive blood pressure waveforms with zero and reference lines
- (2) Selected pressure label
- (3) Selected pressure scale
- (4) Systolic, diastolic and mean pressures
- (5) Ventilation mode selected in the **Px Setup&Alarm** menu

Adjustments

- Press **Menu**.
- Select **NIBP&Inv. Press**.
- Select **Px Setup&Alarm**.



Labeling the invasive line

The label of the pressure channel sets its scale, alarm source and alarm limits. The label alternatives are:

- | | |
|---------------|-----------------------------|
| P1, P2 | Standard labels |
| Art | Arterial pressure |
| CVP | Central venous pressure |
| PA | Pulmonary arterial pressure |
| ICP | Intracranial pressure |

To change the label

- Go to setup menu of the desired pressure.
- Select **Label**.
- Select the desired label from the list.

Table 19-1 Waveform scales, alarm sources and limits that are assigned when the label is selected

Label	P1, Art	P2, CVP	PA	ICP
Scale (mmHg)	200	20	60	20
Alarm source	sys	off	off	off
Digit format	S/D	Mean	S/D	Mean
Filter (Hz)	22	9	9	9

Changing the scale

Scales can be adjusted between 10 and 300 mmHg in steps of 10.

- Go to setup menu of the desired pressure.
- Select **Scale**.
- Adjust the scale by turning and pressing the ComWheel.

Other invasive pressure setup adjustments

Digit Format Select the displayed digit, either, systole and diastole (**S/D**) or **Mean**.

Sweep Speed Set the display sweep speed for the waveform display. The speeds are: **12.5**, **25**, or **50** mm/sec.

NOTE: The sweep speed is same for ECG, plethysmographic, and invasive pressure waveforms.

Ventilation Mode

Select **Spont** or **Contrl** for spontaneous or controlled ventilation. Respiration may cause artifacts in invasive pressure measurement.

HR Source Select the heart rate source. If the ECG signal is affected by too much noise for a reliable heart rate calculation, heart rate can be calculated from pressure (**Art**) or Plethysmographic pulse waveform (**Pleth**). The selected heart rate source is shown above the numerical display of the heart rate.

AUTO selects the first available of: ECG, Art, and Pleth.

Px Alarm Opens a submenu for adjusting Alarm settings, see the "Alarms" chapter.

Previous Menu Return to the **NIBP & Inv. Pressure** menu.

Invasive pressure alarms

Invasive pressure alarm is active only after pressure channel has been zeroed.

For alarm setup, see the *"Alarms"* chapter.

Alarm messages are explained in the chapter *"Maintenance and troubleshooting."*

Measuring principle

The transducer converts the pressure variations into electrical signals. The electrical signals are amplified and displayed as numeric pressure values and waveforms.

20. CARBON DIOXIDE, CO₂

CO₂ can be measured with mainstream method (N-LCM option) using Mainstream CO₂ Sensor and airway adapter.

Respiration rate is the frequency of the peak (end tidal) CO₂ value per minute.

Monitoring mainstream CO₂

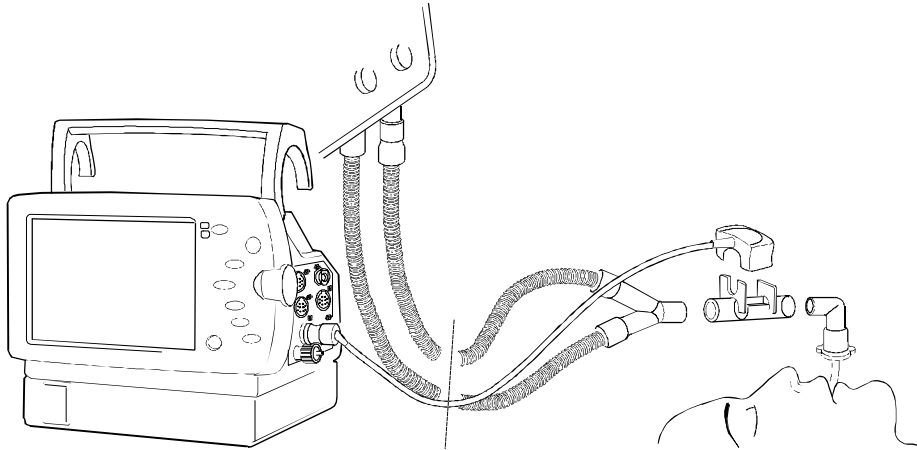
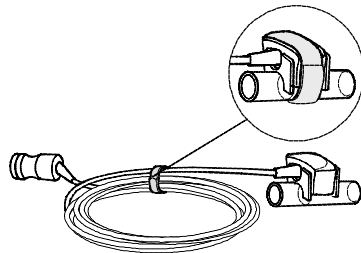

Figure 20-1 Connecting mainstream CO₂ sensor

1. Connect the special airway adapter between the elbow adapter and Y-piece with the saddles upright.
2. Attach the Mainstream CO₂ Sensor to the adapter between the saddles so that the sensor cable fits into the slot on the farther saddle. Ensure the connection between the sensor and the adapter with the Velcro tape supplied with the sensor.



3. Connect the sensor to the connector on the monitor's side panel.
Place the adapter as close to the patient airway as possible. Make sure that the sensor remains in upright position.

To remove the adapter:

- Detach the sensor before removing the adapter from the circuit.

CAUTION Do not apply force to the sensor or sensor cable.

Select the airway adapter according to the patient's status. Refer to the instructions for use provided in the adapters package.

Using the adult/pediatric mainstream airway adapter (endotracheal diameter \geq 5.5 mm) increases the dead space by 6 ml. With the low dead-space airway adapter (diameter $<$ 5.0 mm), the increase is 0.6 ml.

NOTE: Airway adapter selection recommendations should be used as a guideline. It is important for the clinician to assess each patient when selecting the appropriate airway adapter.

WARNING Do not allow the CO₂ sensor to come in contact with the patient's skin for a prolonged period of time. Mainstream sensor is heated to prevent the fogging of the airway windows.

WARNING Do not immerse the sensor in liquids or autoclave it.

WARNING Do not use damaged sensors or adapters.

WARNING Do not clean or sterilize a single use adapter.

Display of CO₂ measurement

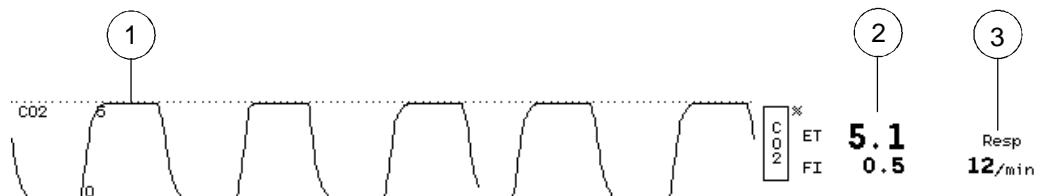
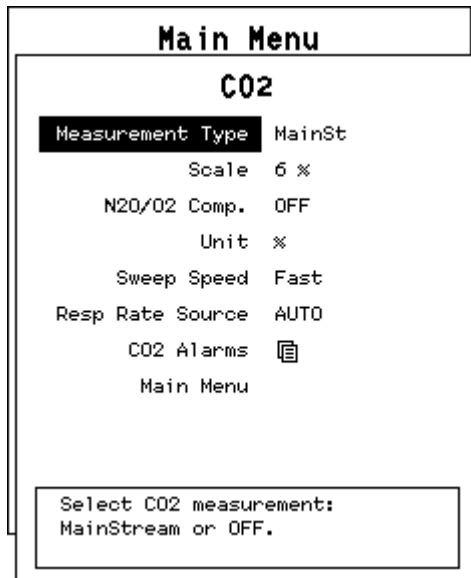

Figure 20-2 Display of the CO₂ waveform

- (1) Continuous CO₂ waveform
- (2) Values of end tidal (ET) and fraction of inspiratory (FI) CO₂
- (3) Respiration rate

CO₂ adjustments



- Measurement** Set on mainstream (**MainSt**) or turn the measurement **OFF**.
- Scale** Selects 0 - 6 %, 0 - 10 %, 0 - 15 %, or kPa and 0 - 50 mmHg, 0 - 80 mmHg, 0 - 100 mmHg. Scale 0 - 6% is used in normal situations, 0 - 10% and 0 - 15% scales are used if hypercarbia is expected.
- N2O/O2 Comp** Selects compensation: **OFF**, **N₂O** or **O₂**. In the breathing circuit when there is 50% or more of N₂O, use N₂O compensation; when there is 60% or more of O₂, use O₂. In other cases, turn off the compensation.
- Unit** Selects CO₂ unit: **%**, **kPa** or **mmHg**. See "Unit conversions" later in this chapter.
- Sweep Speed** Selects **Fast** (6.25 mm/sec) or **Slow** speed (0.62 mm/sec). Slow waveforms have a sweep speed one tenth of normal, for a full screen sweep (five minutes). Slow waveforms show changes better than fast waveforms.
- Resp Rate Source** Change respiration rate source: **AUTO**, **CO₂** or **impedance respiration**.
- CO₂ Alarm** Brings you to the **Alarms Setup** menu to adjust CO₂ alarms.
- Main Menu** Returns you to the **Main Menu**.

Calibration check

No routine calibration by user is required. Calibration check is recommended to be performed once a year by a qualified technical personnel. See the "Technical Reference Manual" for instructions.

Unit conversions

Relationship between gas concentration and its partial pressure:

reading in mmHg = (ambient pressure mmHg * gas concentration in %) / 100

reading in kPa = (ambient pressure in mmHg * gas concentration in %) / 750

Measuring principle

The CO₂ measurement is based on the infrared absorption. In the mainstream method the measurement bench is located at the patient's airway adapter.

21. MAINTENANCE AND TROUBLESHOOTING

WARNING **ELECTRICAL SHOCK HAZARD: Do not remove cover. Refer servicing to qualified service personnel.**

Maintenance

Once a month

- Clean the rear panel dust filter, see the *"Cleaning"* chapter.
- Discharge and recharge the batteries fully.

Once a year

- Check the CO₂ calibration, see *"Technical Reference Manual."*

Checklist

Check the following items to ensure you have remembered the essential preparations before monitoring or if any problems occur during monitoring.

If the monitor does not function as it should and troubleshooting cannot solve the problem, contact your sales representative. Qualified service personnel may use the *"Technical Reference Manual."*

General

Check that the

- monitor doesn't have any visual defects, such as cracks or loose parts.
- power cord with external power adapter is connected to a grounded electrical wall outlet and the voltage selector is set to local voltage.
- patient connection cables are attached to the monitor so that the color coding on the plug matches the color coding on the monitor connector.
- trends of the previous patient are erased.
- alarm limits are suitable for a new patient.

- monitor is used in correct environmental conditions, see “*General specifications.*”

ECG/Respiration

Check that the

- electrode gel is moist.
- electrodes have good skin contact.
- electrodes are positioned correctly.
- correct cable is used: 5-lead cable with 5 lead sets and 3-lead cable with 3-lead sets. (If you have a 3-lead set connected to a 5-lead trunk cable, you must set in the **ECG Setup** menu the selection **5 Lead Cable** to **3elect**).
- ECG trunk cable is connected to the blue connector.
- leadwire set is properly connected to the trunk cable.
- Pacemaker selection in the **ECG Setup** menu is **Show** or **ON R** when a pacemaker is used.
- ECG/Respiration is selected for display in the **Monitor Setup** menu.

For the respiration measurement:

- **PACEMAKER PATIENTS:** The impedance respiration measurement may cause rate changes in Minute Ventilation Rate Responsive Pacemakers. Set the pacemaker rate responsive mode off or turn off the impedance respiration measurement on the monitor.

Pulse oximetry

Check that the

- correct SpO₂ sensor is selected for each patient size.
- sensor is completely dry after cleaning.
- SpO₂ extension cable is connected to the gray connector.
- sensor cable is properly connected to the extension cable.
- sensor is positioned correctly to the patient and the measuring site is well prepared.
- SpO₂ is selected for display in the **Monitor Setup** menu.

Temperature

Check that the

- temperature probe is YSI-400 or equivalent.
- temperature probe is inserted properly into the connector.
- temperature is selected for display in the **Monitor Setup** menu.
- temperature probe is positioned correctly.

Non-invasive blood pressure NIBP

Check that

- the O-rings on hose connectors are intact, two at monitor side.
- the NIBP hose is properly connected to the monitor and will not come loose by pulling.
- the correct NIBP cuff size is used.
- the right hose (black or white) is used for different cuffs.
- the O-ring on cuff connector is intact and the connector firmly pushed inside the cuff tube.
- there are no holes or cracks in the cuff bladder or cuff tube.
- the symbol indicating the center of the bladder is over the artery.
- all residual air is squeezed out of the cuff before wrapping it around the arm.
- the cuff is not loose.
- the cuff is at heart level.
- the tubes are not bent, pressed or stretched.
- if a leak is suspected, start venous stasis and check that the pressure is stable during stasis.
- non-invasive blood pressure is selected for display in the **Monitor Setup** menu.

Invasive blood pressure

Check that

- invasive blood pressure transducer cable is connected to a red connector.
- the pressure transducer is connected to the cable.
- the patient catheter is connected to the pressure line.
- there are no air bubbles in the transducer dome or catheter line.
- the transducer is at mid heart level.
- the pressure transducer is zeroed.
- invasive blood pressure is selected for display in the **Monitor Setup** menu.

CO₂

Check that

- the measurement is set on.
- the sensor is properly attached to the airway adapter. Ensure the connection with the Velcro tape supplied with the CO₂ sensor.
- the sensor is connected to the monitor.
- a new airway adapter is used for each patient. Used adapters may leak and cause too high CO₂ values.

Battery packs and Module

Check that

- battery packs are properly inserted in the module.
- charging LEDs are lit when batteries are fully charged/ flashing during charging / not lit when the monitor is battery driven.
- battery operation with a fully charged battery lasts at least one hour. If not, the battery is old and needs to be replaced.

NOTE: Discharging and recharging the battery regularly lengthens the battery lifetime.

Alarm and information messages

ECG

Alarms

Message	Explanation
Asystole	No QRS complexes in 6 sec. Asystole message is given always from ECG in spite of HR calculation source and only from ECG.
HR high/low	Measured heart rate exceeds the alarm limit.
Leads off	ECG cable, or some or all leads are off. Possibly the DC offset voltage between two electrodes is too high. 3-lead set is used with a 5-lead cable; set in ECG setup menu the selection 5 Lead Cable to 3elect .

Notes

Message	Explanation
Leads off	ECG cable, or some or all leads are off. Possibly the DC offset voltage between two electrodes is too high. 3-lead set is used with a 5-lead cable; set in ECG setup menu the selection 5 Lead Cable to 3elect .
Noise	High frequency noise, e.g. from electrosurgical unit, or 50 Hz from the mains.
Artifact?	Frequent ECG overload or clipping - Elevated baseline noise - Heart rate > 240
Casc.	Two ECG waveforms selected for display.

Impedance respiration

Alarms

Messages	Explanation
Apnea	No breathing detected for 20 seconds.
Resp high/low	Measured respiration rate exceeds the alarm limit.

Notes

Messages	Explanation
Leads off	Cable, or some or all the leads off. Possibly the DC offset voltage between two electrodes is too high.
Measurement off	Measurement has turned off.
Small Resp curve	Signal amplitude < 0.4 Ohm.

Invasive blood pressure

Alarms

Messages	Explanation
P1 (P2) High/Low	Measured P1 (P2) exceeds the alarm limit
HR High/Low	Measured heart rate exceeds the alarm limit.

Notes

Messages	Explanation
No P1 (P2) Transducer	Transducer is not connected.
No Transducer	Transducer is not connected.
Not zeroed	Measurement on, channel is not zeroed.
Zeroing	Zeroing of P1 (P2) in progress.
Zeroed	P1 (P2) zeroed; message time-out 10 seconds.
Zeroing failed	Unsuccessful zeroing of P1 (P2). Retry.
Failed	Unsuccessful zeroing of P1 (P2). Retry.
Zero ICP via menu	ICP must be zeroed through menu.

Zero fail. Prev P1 (P2) zero valid	Zeroing failed. Previous zero value will be used.
Calibrating	Calibrating of P1 (P2) in progress.
Calibrated	P1 (P2) transducer calibrated; message time-out 10 seconds.
Calibration failed	Unsuccessful calibrating of P1 (P2).
Failed	Unsuccessful calibrating of P1 (P2).
Out of range	Measured pressure exceeds > 320mmHg or < -40 mmHg.
Zero adj >100mmHg	Offset over 100 mmHg, reduced range.

NIBP

Alarms

Messages	Explanation
NIBP High/Low	Measured NIBP value exceeds the alarm limit.
(NIBP) Cuff occlusion (with message beep, then caution beep)	Cuff remains pressurized after measurement or becomes pressurized during or between measurements for more than 15 seconds.
(NIBP) Cuff loose, NIBP manual (if cycling stopped)	Cuff not attached to patient or too loose. Hose not connected to the monitor. Measuring mode is changed to manual.
Air leakage (+beep)	Air leakage in cuff or hose, in one of the connectors or inside the module. Measuring mode is changed to manual.
NIBP Air leakage, NIBP manual (if cycling is stopped)	Air leakage in cuff or hose, in one of the connectors or inside the module. Measuring mode is changed to manual.

Notes

Messages	Explanation
Artifacts	Unsuccessful NIBP measurement due to: <ul style="list-style-type: none">- movements- shivering- deep breathing- marked arrhythmia or irregular beats
Weak pulsation	Weak pulsation's due to: <ul style="list-style-type: none">- improper cuff position- weak or abnormal circulation- slow heart rate associated with artifacts- problems with measuring diastolic pressure- small air leakage- insufficient data to artifacts
Cuff overpressure	Cuff is squeezed during measurement and exceeds pressure safety limits. Measurement is canceled and safety valves are opened. Message stays 10 seconds.
Unable to measure Sys	Systolic pressure probably higher than maximum inflation pressure or artifacts in systolic area. Automatic retrial with increased pressure. Message stays 10 seconds.
Unable to measure Dia	Artifacts, accurate diastolic pressure difficult to measure. Message stays 10 seconds.
Unstable zero pressure (+beep)	Unstable zero pressure when cuff is inflated. New measurement in correct time. Measurement stays 10 seconds.
Infl. limits! Check setup (+beep)	Adult or child cuff is used, but the selected infant mode restricts the inflation pressure too low to be able to measure the blood pressure. Message stays 10 seconds.
Long measurement time (+beep)	Measurement time over two min (adult and child mode) and one min (infant mode). Message stays 10 seconds.
Wait for the measurement to be done	When measurement is going and VENOUS STASIS is attempted.
Control measurement	Pressure alarm limit is exceeded. New measurement is performed automatically to check the blood pressure. Message stays 10 seconds.

Call service. Error X (+beep)	NIBP hardware error. Contact authorized service personnel. x = error number 1-99. Message stays on the screen. See Technical Reference Manual.
-------------------------------------	--

Temperature

Alarms

Messages	Explanation
Temp High	Measured temperature value exceeds the alarm limit.

Notes

Messages	Explanation
Performing temp test	During the calibration test.
Temperature error	Error message if calibration test fails.

Pulse oximetry

Alarms

Messages	Explanation
SpO2 probe off	Sensor is not connected to the patient.
No SpO2 pulse	No pulse detected during last 20 seconds or more.
Faulty probe	Damaged probe, probe is present but LEDs take no current.

Notes

Messages	Explanation
Probe off	Sensor is not connected to the patient.
No pulse	Pleth pulses not detected.
Artifact	Interference due to movements or shivering.
Check Probe	Probably faulty sensor or wrong attachment.
Poor signal	Check the sensor site for poor blood circulation. Change site and sensor if needed.

Scale changed Pleth scale changed automatically, 10 s time-out.

With the Nellcor compatible option, N-LNSAT,:

NOTE: Following messages are available also with the N-LNSAT option.

SpO ₂ Low	SpO ₂ ≤ alarm limit
SpO ₂ High	SpO ₂ ≥ alarm limit
HR Low	Pulse rate ≤ alarm limit
HR High	Pulse rate ≥ alarm limit
No SpO ₂ probe	Sensor is not connected to the monitor.
No probe	Sensor is not connected to the monitor.
Pulse search	Searching for appropriate internal gain (and signal levels).
No SpO ₂ pulse?	No pulse detected when the Pleth is selected as HR source.
SpO ₂ probe?	No pulse detected when ECG or Art selected as HR source.

CO₂

Alarms

Messages	Explanation
Resp high/low	Measured respiration rate exceeds the alarm limit.
EtCO ₂ high/low	Measured EtCO ₂ exceeds the alarm limit.
FiCO ₂ high	Measured FiCO ₂ exceeds the alarm limit.
Apnea	No breathing detected for 20 seconds.
No CO ₂ Sensor	Mainstream sensor not been connected.
CO ₂ sensor Failure	CO ₂ sensor malfunctioning.
Unspecified CO ₂ Sensor?	A non-Datex-Ohmeda sensor used.
Use only Datex-Ohmeda mainstream CO ₂ Sensor	Unspecified CO ₂ sensor detected for more than 30 seconds.
Gas module error	CO ₂ measuring failure, contact authorized service.

Clean airway adapter CO₂ sensor airway adapter foggy or dirty.

Clean or replace mainstream CO₂ airway adapter. Blocked airway adapter detected > 30 s.

Notes

Messages

Explanation

Warming	CO ₂ sensor warming up.
O ₂ Compensation	O ₂ compensation selected ON.
N ₂ O Compensation	N ₂ O compensation selected ON.
Over Scale	Waveform is over the selected scale.
Measurement Off	CO ₂ measurement is selected OFF.

DataCard

Notes

Messages

Explanation

Faulty Data Card - change card	DataCard read/write error.
Data Card full	DataCard full of data.
Data Card inserted	DataCard is inserted in the card slot.
Data Card removed	DataCard is removed from the card slot.
Insert Data Card	DataCard is not present during case.
Faulty Data Card: change card	MenuCard or some other card is inserted in the slot.

Battery

Alarms

Messages

Batt Low

Explanation

Note: Less than 10 min of battery time available.

Yellow Alarm: Less than 2 min of battery time available.

Notes

Messages

Batt too warm
to charge

Explanation

Battery temperature > +40°C

Batt too cold
to charge

Battery temperature < +10°C

Recorder

Notes

Messages

Recorder: out of
paper

Explanation

No paper in recorder.

Recorder: cover
open

Recorder cover is open.

Recorder: thermal
array overheat

Thermal array is overheated, recorder does not function.

Recorder: Input
voltage low

Input voltage is too low, recorder does not function.

Recorder: Input
voltage high

Input voltage is too high, recorder does not work.

Recorder: System
error xx

Error in recorder.

Other messages

Messages	Explanation
Monitor temp high. Vent OK?	The temperature inside the monitor is too high. Check ventilation.
STP module error	Error in STP measurement communication.
ECGR module error	Error in ECGR measurement communication.
NIBP module error	Error in NIBP measurement communication.
CO2 module error	Error in CO ₂ measurement communication.
NSAT module error	Error in NSAT measurement communication.
Case Started	Vital signs have been detected.
Case Ended	Vital signs are not detected any longer.
RAM Error	RAM error detected.
SRAM Error	SRAM error detected.
FLASH Error	FLASH error detected.
Printing...	Printing is active.
Printer failure	Failure in printer.

Troubleshooting

What if...	Try this:
CO ₂ readings are unreliable.	<ul style="list-style-type: none"> • Check that the sensor is properly attached to the adapter. Ensure the connection with the Velcro tape supplied with the CO₂ sensor.
ECG signal is noisy, or no QRS is detected.	<ul style="list-style-type: none"> • Ensure that the patient is not shivering. • Check electrodes quality, positioning and skin contact. • Change lead. • Enlarge the size from 1.0 mV to 2.0 mV.
Invasive blood pressure readings are unreliable.	<ul style="list-style-type: none"> • Make sure that there are no air bubbles in transducer system. Flush and zero. • Place transducer on patient's mid-heart level, and zero.
'Zeroing failed'-message is displayed, when the Zero ALL key is pressed.	<p>Stopcock not opened to room air on all channels:</p> <ul style="list-style-type: none"> • Zero, or continue if the lines have been zeroed separately.
NIBP measuring does not work or values are unreliable.	<ul style="list-style-type: none"> • Use cuffs of correct size and check that cuff tubings are not bent, stretched, compressed or loose. • Prevent motion artifacts. • Make sure that the patient is not shivering.
Respiration measurement fails.	<ul style="list-style-type: none"> • Check electrode quality and positioning. • Adjust the detection limits.
SpO ₂ signal is poor.	<ul style="list-style-type: none"> • Check sensor placement. • Be aware of differences caused by skin pigment. • Make sure that the patient is not shivering.
Temperature measuring fails.	<ul style="list-style-type: none"> • Check that you have the correct kind of probe. Try another probe.
The monitor does not start.	<p>The power cord is not connected:</p> <ul style="list-style-type: none"> • Connect the power cord to the power outlet. <p>Battery empty:</p> <ul style="list-style-type: none"> • Replace battery with a recharged one. <p>Fuses blown:</p> <ul style="list-style-type: none"> • Check the fuses, replace if necessary or contact your local service.
Monitor is very warm.	<p>Dust filter is blocked:</p> <ul style="list-style-type: none"> • Clean or replace the back panel dust filter.
Batteries are not recharged.	<p>Batteries are not properly inserted, power supply not connected, or monitor too warm or cold:</p> <ul style="list-style-type: none"> • Wait for monitor to cool down/warm up. <p>Recharge only in room temperature.</p>
Battery operation lasts less than specified.	<p>Batteries are not fully charged:</p> <ul style="list-style-type: none"> • Charge batteries fully, and check operation. <p>Battery pack is faulty, or too old:</p> <ul style="list-style-type: none"> • Replace the battery pack with a new one.
'Batt Low'-message.	<p>Less than 10 min of battery time left:</p> <ul style="list-style-type: none"> • Replace with fully charged batteries, or plug in the power cord.

22. GENERAL SPECIFICATIONS

Parameter specifications

ECG

Measured leads:	I, II or III
Frequency response:	0.5...30 Hz (-3 dB, with 50 Hz reject filter) 0.5...40 Hz (-3 dB, with 60 Hz reject filter)
Sweep speed:	12.5, 25, or 50 mm/s

Heart rate/Pulse rate

Measurement range:	30...250 bpm
Measurement accuracy:	$\pm 5\%$ or ± 5 bpm whichever is greater
Display resolution:	1 bpm
Averaging time:	10 s
Display update time:	5 s
Alarms:	asystole, leads-off detection, adjustable high and low alarm limits for heart rate
Gain range:	0.2...5.0 cm/mV
Allowable DC differential offset:	± 300 mV
Pacemaker pulse detection:	detection level: 5...500 mV, pulse duration: 0.5...2 ms

Impedance respiration

Measuring range:	Impedance, 0.2...6 Ohm
Max. base impedance:	5 kOhm
Respiration range:	4...120 resp/min
Accuracy:	$\pm 5\%$ or ± 5 resp/min whichever is greater

Averaging:	30 s
Update interval:	10 s
Display resolution:	1 resp/min
Sweep speed (trace):	slow 0.62 mm/s, fast 6.25 mm/s
Alarms:	apnea, adjustable high and low alarm limits for respiration rate
Gain range:	0.1...5 cm/Ohm

Pulse oximetry (SpO₂)/Pleth

Measurement method:	red and infrared light absorption SpO ₂
Measurement range:	40...100 %
Calibration range:	50...100 %; calibrated against functional oxygen saturation
- with N-LNSAT:	70...100 %; calibrated against functional oxygen saturation
Display resolution:	1 digit (1 % of SpO ₂)
Measurement accuracy ^{*)} :	100...80 %, ± 2 digits (± 1SD) 80...50 %, ± 3 digits (± 1SD) 50...40 %, unspecified
- with N-LNSAT ^{**)} :	100...70 %, ± 2 digits (± 1SD) for sensor types D-25/D-25L, N-25, D-20, I-20 100...70 %, ± 2,5 digits (± 1SD) for sensor OXICLIQ A, OXICLIQ P 100...70 %, ± 3 digits (± 1SD) for sensor types D-YS, DS-100A, OXI-A/N, OXI-P/I 100...70 %, ± 3,5 digits (± 1SD) for sensor type R-15 70...40 %, unspecified
Display averaging time:	adjustable 20 s, 10 s, or beat-to-beat
- with N-LNSAT:	adjustable slow, normal or fast
Alarms:	probe off, no probe, no pulse, adjustable high and low, alarm limits for SpO ₂

Pulse rate

Measurement range:	30...250 bpm
Display resolution:	1 digit (1 bpm)
Measurement accuracy:	$\pm 5\%$ or ± 5 bpm
- with N-LNSAT:	± 3 bpm
Alarms:	adjustable high and low alarm limits for pulse rate

Plethysmographic pulse waveform

Scales:	proportional scaling: 2, 5, 10, 20, 50 mod % or automatic scaling
- with N-LNSAT:	automatically scaled by the measurement board, the actual scale unknown.

^{*)} Accuracy is based on deep hypoxia studies using Datex-Ohmeda Finger Sensors on volunteered subjects. Arterial blood samples have been analyzed by a Radiometer OSM Co-oximeter. Refer to Datex-Ohmeda Sat Sensor directions for specific SpO₂ accuracy.

^{**)} Option N-LNSAT: Accuracy specifications are based on testing the monitor and sensor on healthy adult volunteers in induced hypoxia studies.

Temperature

Measurement units:	$^{\circ}\text{C}$ or $^{\circ}\text{F}$
Measurement range:	10...45 $^{\circ}\text{C}$ (50...113 $^{\circ}\text{F}$)
Measurement resolution:	0.1 $^{\circ}\text{C}$ (0.1 $^{\circ}\text{F}$)
Measurement accuracy:	± 0.1 $^{\circ}\text{C}$ (25...45.0 $^{\circ}\text{C}$) ± 0.2 $^{\circ}\text{C}$ (10...24.9 $^{\circ}\text{C}$)
Probe type:	Compatible with YSI 400 series

Non-invasive blood pressure

Measurement principle:	oscillometric with linear deflation
Deflation speed:	heart rate dependent, 5...13 mmHg/s
Measurement range:	adult 25...260 mmHg child 25...190 mmHg infant 15...140 mmHg
Pulse rate range:	30...250 bpm

Numeric display:	systolic, diastolic and mean arterial pressure		
Alarms:	cuff loose, cuff occlusion, adjustable high and low alarm limits for systolic, diastolic, mean or off		
Typical measurement time:	adult 23 s and infant 20 s		
Safety features:	adult	child	infant
Initial inflation pressure (mmHg):	185	150	120
Max. inflation pressure (mmHg):	280	200	150
Overpressure limit (max. 2 s; mmHg):	320	220	165
Max. inflation time (>13 mmHg, min):	2	2	1
Safety valve (mmHg):	320	220	165

Invasive blood pressure (F-LMP1 models only)

Measurement range:	-40...320 mmHg
Measurement accuracy:	± 5 % or ± 2 mmHg
Numeric display	
Range:	40...320 mmHg
Resolution:	1 mmHg
Averaging:	over 5 s or end-expiratory filtering
Display update:	every 5 s
Alarms:	adjustable high and low alarm limits for systolic, diastolic and mean pressures, or off

Waveform display

Range:	-30...300 mmHg
Scales:	adjustable in 10 mmHg increments

Pulse rate

Measurement range:	30...250 bpm
Resolution:	1 bpm

Resolution:	1 bpm
Accuracy:	± 5 % or 5 bpm
Transducer sensitivity:	5 µV/V/mmHg, 5 Vdc, max.20 mA
Pressure filter:	22 Hz (-3 dB) for P1, Art 9 Hz (-3dB) for P2, CVP, PA, ICP

CO₂ (option N-LCM)

Principle of operation:	Non-dispersive infrared, single beam, single frequency, fully chopped, ratiometric
Measurement range:	0-99 mmHg / 0-13 vol-% / 0-13 kPa
Accuracy ^{**)}	0-40 mmHg /0-5.3 vol-%: ± 2 mmHg / ±0.3 vol-% 41-76 mmHg /5.3-10 %: ± 5 % of reading 77-99 mmHg /10-13 %: ± 10 % of reading
Respiration rate measurement range:	4-150 breaths/minute
Pressure compensation:	automatic, continuous
Gas compensations:	User selectable O ₂ , N ₂ O or OFF
Calibration:	No routine calibration required; automatic self-calibration every 30 ms
Alarms:	adjustable high and low alarm limits for Et/Fi CO ₂ and respiration rate
CO ₂ sensor weight:	< 18,5 g (excluding cable)
Cable length:	3 meters
Warm-up time:	< 80 seconds from 25 °C / 77 °F
Response time:	100 ms

**) typical value in conditions 22,5°C, 760 mmHg, CO₂ in balance air, I:E 1:2

General

Monitor (WxDxH):	325 x 160 x 210 mm / 12.8 x 6.3 x 8.3"
Battery module (WxDxH):	290 x150 x 40 mm / 11.4 x 5.9 x 1.6"
Weight:	4.2 kg/9.3 lb.
Weight w/ battery:	6.1 kg/13.5 lb.

Input voltage:	12.5 V DC
Power consumption	17.5 ... 37 W depending on the options used
Safety standards:	Designed to meet IEC 60601-1, CAN/CSA C22.2 No. 601.1-M90 and UL 2601-1, CE-marking according to Directive 93/42/EEC
Output specifications:	RS-232 computer serial output Defibrillation synchronization signal (According to ANSI/AAMI EC13-1992. Time interval from R peak to sync pulse output \leq 35 ms.) Nurse Call Analog output, 2 fixed and 2 freely configurable outputs
Printing:	Local printing with laser printer (PCL5), or via network.
Recorder option:	Built-in three channel thermal array recorder.

Environmental conditions

Operating temperature:	0...40 °C (32...104 °F), CO ₂ and Nellcor options +5...40 °C (41...104 °F) mainstream sensor +10...40 °C (50...104 °F) Nellcor measurement optimal temp.+28...40 °C (82...104 °F) Battery charging temperature 10...40 °C (50...104 °F)
Storage temperature:	-30...70 °C (-22...158 °F), -20...60 °C (-4...140 °F) with CO ₂ -30...50 °C (-22...122 °F) for batteries
Relative humidity:	5...95 % non-condensing
Mechanical shock	50g, 11 ms

For accessories, please refer to the Datex-Ohmeda Patient Monitor supplies and accessories catalogue.

Specifications subject to change without notice.

Display

Display size and type:	9" monochrome EL display
Number of traces:	Up to 4
Display resolution:	640 x 400
Display layout:	User-configurable

Integrated direct function keys, menu key and ComWheel™ for selections and adjustments in menus.

Trends

Graphical:	2, 4, 12 and 24 h
Numerical:	all parameters, sampled every 5 min and after NIBP measurement
Trend cursor:	both in graphical and numerical trends

Alarms

- Adjustable high and low alarms for HR, Resp, NIBP, SpO₂ Temp, CO₂ (Et/Fi) and Invasive Pressures Alarm system classified according to priority; visually with color and audio tone coded.
- Central alarm display and adjustment page.
- 10 min graphical mini trends referenced to set alarm limits.
- Automatic alarm limits function; alarm limits automatically calculated from current parameter reading when selected.
- Alarms history displaying 10 latest alarms.

Light Monitor Battery Module (optional) (w/2 battery slots)

Type:	NiCd battery
Capacity:	Up to 2 hours (1 h/batt) typical on full charge at 23 °C / 73 °F
Recharging:	When connected to line power or DC (N-LPOW or N-LPOWT)
Charging time:	3.5 h / battery to full capacity

S/5 Light Monitor Backup Battery (optional)

Type:	NiCd battery
Capacity:	Up to 30 min typical on full charge at 23 °C / 73 °F
Recharging:	When connected to line power or DC (N-LPOW or N-LPOWT).
Charging time:	1.5 h / battery to full capacity

External Power Adapter

N-LPOW

AC voltage range:	220-240 V / 100-120 V ~ 50/60 Hz
Allowed AC voltage fluctuations:	100 V -10 %...120 V +10 %, 220 V -10 %...240 V +10 %
DC output voltage:	12.5 V and 18.5 V
Protection class:	Class I
Grounding:	Hospital grade

Power Adapter for transport vehicles (optional)

N-LPOWT

Input voltage range and fluctuations:	12 Vdc -15 %...32 Vdc +10 %
Output voltage:	12.5 Vdc and 18.5 Vdc

Option codes

Description	Order code
S/5 Light Monitor	F-LM1 w/ ECG, Resp, NIBP, SpO ₂ , Temp
S/5 Light Monitor	F-LMP1 w/ ECG, Resp, NIBP, SpO ₂ , Temp, 2xIBP
Light Monitor Power Adapter	N-LPOW Power adapter, 110/220 V
Light Monitor Transport Power Adapter	N-LPOWT Transport power adapter, 12-32 V
Light Monitor Battery Module	F-LBAT Battery module w/ two batteries
Light Monitor Recorder	N-LREC Built-in 3-channel thermal array recorder
S/5 Light Monitor CO ₂ Option	N-LCM Mainstream CO ₂
Mainstream CO ₂ sensor	902300
DataCard Option	N-LDATA
Network Option	N-LNET
DataCard & Network Option	N-LDNET
Nellcor SpO ₂ Option	N-LNSAT
External Battery Charger w/two batteries	N-LCHGR

Nurse call and defibrillator synchronization signals

The nurse call signal is generated when the alarm is activated. Alarm silencing suppresses the nurse call signal.

The defibrillator synchronization digital signal is generated by ECG. The pulse will be given on each rising R-wave edge on QRS-complex. The pulse amplitude is 5 V and width is 10 ms. When the def sync signal is active, the signal is set to state 1. After 10 ms the state is set to 0. A new pulse will not be generated before the previous pulse is deactivated.

WARNING PATIENT SAFETY:
Use only cables with shielding against electromagnetic interference.

WARNING Do not use delayed analog signals for defibrillator and intra-aortic balloon pump synchronization.

23. ACCESSORIES

CAUTION Use only cables and accessories approved by Datex-Ohmeda. Other cables and accessories may damage the system or interfere with measurement.

For further information on the accessories listed below, see the catalogue "Datex-Ohmeda Patient Monitor Supplies and Accessories."

GAS MONITORING

Mainstream CO₂ accessories

Product name	Order code	Specification	Note
Mainstream CO ₂ sensor	902300	Mainstream CO ₂ sensor	Use with S/5 Light Monitor (F-LM1, F-LMP1)
Mainstream CO ₂ airway adapter	902301 pkg of 10 pcs	Single use mainstream CO ₂ airway adapter, adult/pediatric Dead space: 6 ml Connectors: 15F-15M Maximum flow: 120 l/min.	Use with S/5 Light Monitor (F-LM1, F-LMP1)
Mainstream CO ₂ airway adapter	902302 pkg of 10 pcs	Single use mainstream CO ₂ airway adapter, low dead space Dead space: <1 ml Connectors: 15F-15M Maximum flow: 30 l/min.	Use with S/5 Light Monitor (F-LM1, F-LMP1)
Mainstream CO ₂ airway adapter	902304 pkg of 3 pcs	Reusable mainstream CO ₂ airway adapter, adult/pediatric Dead space: 6 ml Connectors: 15F-15M Maximum flow: 120 l/min.	Use with S/5 Light Monitor (F-LM1, F-LMP1)

Calibration gases

Product name	Order code	Specification	Note
Calibration gas regulator	755533	Regulator for QUICK CAL calibration gas cans	Use with calibration gas, aerosol cans: 755580 755581 755582 755583
QUICK CAL calibration gas	755580 pkg of 4 cans	QUICK CAL calibration gas, aerosol can	Use with regulator 755533

		Contains: 5.0% CO ₂ Balance air Accuracy: 0.5% relative	
Calibration Check Adapter Kit	902305	CO ₂ Calibration Check Adapter and silicon tube	For 755580
Y-fitting for gas regulator	733831	Y-fitting for calibration gas regulator	For 755533 and 755530

PULSE OXIMETRY SENSORS

Sat Sensors, reusable

Product name	Order code	Specification	Note
FingerSat Sensor	SAS-F4	Cable 4 m/13 ft	Standard sensor for adults and children. Recommended use: short term monitoring, OR.
FingerSat Sensor	SAS-F	Cable 1.3 m/4 ft	Standard sensor for adults and children. Recommended use: short term monitoring, OR. Requires Sat Sensor Cable.
FlexSat Sensor	SAS-W	Cable 1 m/3 ft, includes cloth wrap.	Multisite sensor for adults and infants. Recommended use: long term monitoring, ICU and PACU. Requires Sat Sensor Cable.
EarSat Sensor	SAS-E	Cable 1 m/3 ft	Multisite sensor for adults and infants. Recommended use: short term monitoring, PACU. Requires Sat Sensor Cable.

Sat Sensors, single patient

Product name	Order code	Specification	Note
Single patient Sat Sensor	16580 pkg of 12 pcs	Infant, cable 0.7 m/2 ft	Recommended use: long term monitoring, ICU. Requires Sat Sensor Cable.
Single patient Sat Sensor	16581 pkg of 12 pcs	Pediatric, cable 0.7 m/2 ft	Recommended use: long term monitoring, ICU. Requires Sat Sensor Cable.
Single patient Sat Sensor	16582 pkg of 12 pcs	Adult, cable 0.7 m/2 ft	Recommended use: long term monitoring, ICU. Requires Sat Sensor Cable.

Sat Sensor cables

Product name	Order code	Specification	Note
Sat Sensor Cable	SAS-C1	Cable 1.5 m/5 ft	Use only with Datex-Ohmeda Sat Sensors.
	SAS-C3	Cable 3.0 m/10 ft	Use only with Datex-Ohmeda Sat Sensors.
Sat Sensor Cable	SAS-C10	Cable 10 m/33 ft	Use only with Datex-Ohmeda Sat Sensors.

Clips, wraps and tapes

Product name	Order code	Specification	Note
Bed sheet clip	891192 pkg of 3 pcs	Bed sheet clip	
Cloth wrap	731040 pkg of 25 pcs	Cloth wrap	Use with FlexSat and Flexalite Sensors.
Preparation tape	875282 pkg of 12 pcs	Preparation tape for ear application	Use with FlexSat and Flexalite Sensors.

ECG CABLES

NOTE: All Datex-Ohmeda ECG cables can be used for respiration monitoring with Datex-Ohmeda S/5 monitors.

ECG trunk cables, IEC color coding

Product name	Order code	Specification	Note
300-Series 3-lead trunk cable, IEC	545305	300-Series 3-lead trunk cable 1.2 m/4 ft, IEC color coding	Requires 300-Series lead set with IEC color coding.
	545300	300-Series 3-lead trunk cable 3.0 m/ 10 ft, IEC color coding	Requires 300-Series lead set with IEC color coding.
	545304	300-Series 3-lead trunk cable 5.0 m/ 16 ft, IEC color coding	Requires 300-Series lead set with IEC color coding.
300-Series 5-lead trunk cable, IEC	545306	300-Series 5-lead trunk cable 1.2 m/4 ft, IEC color coding	Requires 300-Series lead set with IEC color coding.
300-Series 5-lead trunk	545301	300-Series 5-lead trunk	Requires 300-Series lead set

cable, IEC		cable 3.0 m/10 ft, IEC color coding	with IEC color coding.
------------	--	--	------------------------

ECG lead sets, IEC color coding

Product name	Order code	Specification	Note
300-Series 3-lead set, IEC	545315	300-Series 3-lead set with clips, 75 cm/ 30 in, IEC color coding	Detachable leads. Requires 300-Series trunk cable with IEC color coding.
300-Series 5-lead set, IEC	545316	300-Series 5-lead set with clips, 125 cm/ 49 in (leg) and 75 cm/30 in (chest), IEC color coding	Detachable leads. Requires 300-Series trunk cable with IEC color coding.

ECG trunk cables, AAMI color coding

Product name	Order code	Specification	Note
300-Series 3-lead trunk cable, AAMI	545307	300-Series 3-lead trunk cable 1.2 m/4 ft, AAMI color coding	Requires 300-Series lead set with AAMI color coding.
	545302	300-Series 3-lead trunk cable 3.0 m/10 ft, AAMI color coding	Requires 300-Series lead set with AAMI color coding.
300-Series 5-lead trunk cable, AAMI	545308	300-Series 5-lead trunk cable 1.2 m/4 ft, AAMI color coding	Requires 300-Series lead set with AAMI color coding.
300-Series 5-lead trunk cable, AAMI	545303	300-Series 5-lead trunk cable 3.0 m/10 ft, AAMI color coding	Requires 300-Series lead set with AAMI color coding.

ECG lead sets, AAMI color coding

Product name	Order code	Specification	Note
300-Series 3-lead set, AAMI	545317	300-Series 3-lead set with clips, 75 cm/ 30 in, AAMI color coding	Detachable leads. Requires 300-Series trunk cable with AAMI color coding.
300-Series 5-lead set, AAMI	545318	300-Series 5-lead set with clips, 125 cm/ 49 in (leg) and 75 cm/30 in (chest), AAMI color coding	Detachable leads. Requires 300-Series trunk cable with AAMI color coding.
300-Series 3-lead set, AAMI	545327	300-Series 3-lead set with snaps, 75 cm / 30 in, AAMI color coding	Detachable leads. Requires 300-Series trunk cable with AAMI color coding.
300-Series 5-lead	545328	300-Series 5-lead set with snaps,	Detachable leads.

set, AAMI		125 cm /49 in (leg) and 75 cm/30 in (chest), AAMI color coding	Requires 300-Series trunk cable with AAMI color coding.
-----------	--	--	---

ECG replacement clip leads

Product name	Order code	Specification	Note
300-Series replacement clip lead	545340	300-Series replacement clip lead, red R, 75 cm/30 in	
	545341	300-Series replacement clip lead, green F, 75 cm/30 in	
	545342	300-Series replacement clip lead, yellow L, 75 cm/30 in	
	545343	300-Series replacement clip lead, white C, 75 cm/30 in	
	545344	300-Series replacement clip lead, black LA, 75 cm/30 in	
	545345	300-Series replacement clip lead, brown V, 75 cm/30 in	
	545358	300-Series replacement clip lead, red LL, 75 cm/30 in	

Product name	Order code	Specification	Note
300-Series replacement clip lead	545359	300-Series replacement clip lead, white RA, 75 cm/30 in	
	545346	300-Series replacement clip lead, red LL, 125 cm/49 in	
	545347	300-Series replacement clip lead, green F, 125 cm/49 in	
	545348	300-Series replacement clip lead, black N, 125 cm/49 in	
	545349	300-Series replacement clip lead, green RL, 125 cm/49 in	

ECG replacement snap leads

Product name	Order code	Specification	Note
300-Series replacement snap lead	545350	300-Series replacement snap lead, red LL, 75 cm/30 in	
	545351	300-Series replacement snap lead, black LA, 75 cm/30 in	
	545352	300-Series replacement snap lead, white RA, 75 cm/30 in	

	545353	300-Series replacement snap lead, brown V, 75 cm/30 in	
	545354	300-Series replacement snap lead, red LL, 125 cm/49 in	
	545355	300-Series replacement snap lead, green RL, 125 cm/49 in	

ECG cables, miscellaneous

Product name	Order code	Specification	Note
Combiner for 300-Series 3-lead set	545390 pkg of 3 pcs	Combiner for 300-Series 3-lead sets	
Combiner for 300-Series 5-lead set	545391 pkg of 3 pcs	Combiner for 300-Series 5-lead sets	
Organizer for 300-Series 3-lead set	545392 pkg of 10 pcs	Organizer for 300-Series 3-lead sets	
Organizer for 300-Series 5-lead set	545393 pkg of 10 pcs	Organizer for 300-Series 5-lead sets	
Bed sheet clip	891192 pkg of 3 pcs	Bed sheet clip	Use with all Datex-Ohmeda ECG cables.

Electrodes

Product name	Order code	Specification	Note
ECG electrode	572683 pkg of 50 pcs	ECG electrodes, solid gel, Ag/AgCl	Disposable.
Infant ECG electrode	572684 pkg of 15 pcs	Infant ECG electrodes, safety pin (DIN 42- 802) connector, solid gel, Ag/AgCl	Disposable. Connects directly to 300-Series trunk cable.

TEMPERATURE PROBES

Temperature probes, reusable

Product name	Order code	Specification	Note
Skin temperature probe	16560	2.8 m/9 ft, 400 series thermistor, \varnothing 10 mm, tc = 4.5 sec Accuracy: 0-25 °C \pm 0.2 °C 25-50 °C \pm 0.1 °C	For adults and infants. Can be autoclaved at 121 °C/250 °F.
Central temperature probe	16561	Adult, 2.8 m/9 ft, 400 series thermistor, \varnothing 4 mm, tc = 6.9 sec Accuracy: 0-25 °C \pm 0.2 °C	Oesophageal or rectal. Can be autoclaved at 121 °C/250 °F.

		25-50°C ± 0.1°C	
	165611	Pediatric, 2.8 m/ 9 ft, 400 series thermistor, Ø 3 mm, tc = 3.2 sec Accuracy: 0- 25°C ± 0.2°C 25- 50°C ± 0.1°C	Oesophageal or rectal. Can be autoclaved at 121°C/250°F.

NIBP CUFFS

NIBP cuffs, reusable

Product name	Order code	Specification	Note
Reusable cuff	572436	Large adult Color code: red For arm circumference 33 - 47 cm	Requires black adult hose.
	572435	Standard adult Color code: blue For arm circumference 25 - 35 cm	Requires black adult hose.
Reusable cuff	572434	Small adult Color code: gray For arm circumference 18 - 26 cm	Requires black adult hose.
	877408	Child Color code: green For arm circumference 10 - 19 cm	Requires black adult hose.
Reusable infant cuff	877407	Infant Color code: tan For arm circumference 9 - 14 cm	Requires white infant hose.
Replacement cover, adult	572437	Replacement cover for standard adult cuff 572435 Color code: blue	

NIBP cuffs, single use

Product name	Order code	Specification	Note
Single use infant cuff	572405 pkg of 10 pcs	Infant cuff #5, for arm circumference 9.6 cm - 14.3 cm	Requires white infant hose.

NIBP cuff hoses

Product name	Order code	Specification	Note
Adult hose, black	877235	Black, 3 m/10 ft	Use with NIBP cuffs 572436,

			572435, 572434, 877408.
	879739	Black, 6 m/20 ft	Use with NIBP cuffs 572436, 572435, 572434, 877408.
Infant hose, white	877514	White, 3 m/10 ft	Do not use with Light Monitor F-LM and F-LMP. Use with reusable NIBP cuff 877407 and single use cuffs 572403, 572404, 572405.
Infant hose, white	890639	White, 6 m/20 ft	Do not use with Light Monitor F-LM and F-LMP. Use with reusable NIBP cuff 877407 and single use cuffs 572403, 572404, 572405.

Connectors

Product name	Order code	Specification	Note
Plastic connectors	64655	Plastic connectors for upgrading adult NIBP cuffs and hoses	For cuffs: 572434, 572435, 572436, 877408 For hoses: 877235, 879739, 877913

INVASIVE BLOOD PRESSURE TRANSDUCERS

NOTE: Companies like Abbott, Baxter/Edwards, COBE, Beckton-Dickinson and Utah Medical can provide adapter cables for Datex-Ohmeda monitors to be used with disposable transducers from these companies.

InvBP transducers and cables, reusable

Product name	Order code	Specification	Note
Reusable InvBP transducer	16576	SensoNor 840, 3 m/10 ft Sensitivity: 50 μ V/V/cmHg	Requires disposable dome 16578 and flushing kit 16577.
Reusable transducer	165700	Spectramed P10EZ-1, 0.45 m/1.5 ft. Sensitivity: 50 μ V/V/cmHg	Requires flushing kit 16571 and adapter cable 54586.
Holder for InvBP transducer	16579	Holder for 2 x SensoNor 840 transducers	
Adapter cable	54586	Cable 3.8 m/12 ft	Use with Beckton-Dickinson DTX disposable pressure transducers or Spectramed P10EZ-1.
Adapter cable	875408	Cable 30 cm/1 ft	Use with HP 1290C-type pressure transducers.

Flushing kits, disposable

Product name	Order code	Specification	Note
Disposable flushing kit	16577 pkg of 10 kits	Disposable flushing kit for transducer SensoNor 840	Sterile. Each kit includes tubing and one dome.
Disposable dome	16578 pkg of 50 pcs	Disposable dome for transducer SensoNor 840	Sterile.
Disposable flushing kit	16571 pkg of 5 kits	Disposable flushing kit for transducer Spectramed P10EZ-1	

INTERFACE CABLES

Interface cables for configured monitors

Product name	Order code	Specification	Note
Light Monitor-Printer cable	894193	Light Monitor, models F-LM1 and F-LMP1 - printer cable	Local laser printer cable (PCL5).

MOUNTING ELEMENTS

Product name	Order code	Specification	Note
Portable monitor wall mount	572238	Portable Monitor Wall Mount	Requires mounting plate 890915 for Light Monitor. Max. load 27 kg.
Portable monitor roll stand	572235	Portable Monitor Roll Stand	Requires mounting plate 890915 for Light Monitor. Includes basket for monitor accessories.
Light monitor mounting plate	890915	Light Monitor Universal Mounting Plate	Mounts Light Monitor to Portable Monitor Wall Mount, Portable Monitor Roll Stand and to a fixed vertical pole within diameter range: 25 - 32 mm (1 - 1.25 in) with maximum load of 7.5 kg (16.5 lbs). Includes mounting plate adapter 572623.
Mounting plate adapter	572623	Mounting plate adapter for Light Monitor	Included in Light Monitor Universal Mounting Plate, 890915.
Light Monitor protective case	737731	Protective case for Datex-Ohmeda Light Monitor	

MISCELLANEOUS

Product name	Order code	Specification	Note
Light Monitor battery	896895	Light Monitor Battery Module w/2 batteries, F-LBAT	For Light Monitor. NiCd battery.
Light Monitor data card	887045	Light Monitor data card for models F-LM1 and F-LMP1	English. Allows data storage of physiological trends for data continuum.
	887047	Light Monitor data card for models F-LM1 and F-LMP1	French. Allows data storage of physiological trends for data continuum.
Dust filter	886841	Dust filter	For Datex-Ohmeda Light Monitor.
Thermal recorder paper	74205 pkg of 20 rolls	Thermal recorder paper - width 50 mm/2 in	

ACCESSORY KITS

Hemodynamic accessory kits

Product name	Order code	Specification	Note
Hemodynamic accessory kit	877973	<ul style="list-style-type: none"> – 1 adult NIBP hose (877235) – 1 standard adult cuff (572435) – 1 three-lead trunk cable, IEC color coding (545300) – 1 three-lead set, IEC color coding (545315) – 1 adult central temperature probe (16561) – 1 Sat Sensor Cable, 3 m/10 ft (SAS-C3) – 1 FingerSat Sensor, cable 1.3 m/4 ft (SAS-F) 	Includes ECG cables with IEC color coding.
Hemodynamic accessory kit	877974	<ul style="list-style-type: none"> – 1 adult NIBP hose (877235) – 1 standard adult cuff (572435) – 1 three-lead trunk cable, AAMI color coding (545302) – 1 three-lead set, AAMI color coding (545317) – 1 adult central temperature 	Includes ECG cables with AAMI color coding.

		probe (16561) – 1 Sat Sensor Cable, 3 m/10 ft (SAS-C3) – 1 FingerSat Sensor, cable 1.3 m/4 ft (SAS-F)	
NIBP, ECG and SpO ₂ accessory kit	890935	– 1 adult NIBP hose (877235) – 1 standard adult cuff (572435) – 1 three-lead trunk cable, IEC color coding (545300) – 1 three-lead set, IEC color coding (545315) – 1 Sat Sensor Cable, 3 m/10 ft (SAS-C3) – 1 FingerSat Sensor, cable 1.3 m/4 ft (SAS-F)	Includes ECG cables with IEC color coding.
NIBP, ECG and Temp accessory kit	877971	– 1 adult NIBP hose (877235) – 1 standard adult cuff (572435) – 1 three-lead trunk cable, IEC color coding (545300) – 1 three-lead set, IEC color coding (545315) – 1 adult central temperature probe (16561)	Includes ECG cables with IEC color coding.
NIBP, ECG and Temp accessory kit	877972	– 1 adult NIBP hose (877235) – 1 standard adult cuff (572435) – 1 three-lead trunk cable, AAMI color coding (545302) – 1 three-lead set, AAMI color coding (545317) – 1 adult central temperature probe (16561)	Includes ECG cables with AAMI color coding.

SpO₂ accessory kit

Product name	Order code	Specification	Note
SpO ₂ accessory kit	875697	– 1 Sat Sensor Cable, 3 m/10 ft (SAS-C3) – 1 FingerSat Sensor, cable 1.3 m/4 ft (SAS-F)	

24. INDEX

A

AAMI Codes, ECG electrodes, 57
Adapters
 mainstream CO₂, 57
Adjusting
 alarm limits, 29
 alarm volume, 29
 beat volume, 57
 CO₂ scale, 57
 default settings, 29
 ECG settings, 57
 invasive blood pressure settings, 57
 monitor settings, 29
 NIBP settings, 57
 pulse oximetry settings, 57
 Respiration display, 57
 screen, 29
 temperature settings, 57
 time and date, 29
 trends, 29
Alarm
 sound, 29
Alarms, 29
 audio alarm pattern, 29
 auto limits, 29
 automatic recording, 29
 categories, 29
 default limits, 29
 pulseoximetry, 57
 Reminder volume, 29
 setup, 29
 silencing, 29
 smart start, 29
 source, 29
Alcohol
 cleaning, 15
Arrhythmia
 Warning, 1
Artefacts

 Of movement, 57
 Respiration, 57
AS/3 monitors, 29
Auto alarm limits, 29
Autoclave, 15
Autocycling, 57
Automatic Alarm Recording, 29

B

Backup Battery, 15
Batteries, 1, 15
 cautions, 1
 charging, 1, 15
 checklist, 91
 disposing of, 15
 removing, 15
 storing, 15
Battery alarm, 15
Battery Module, 15
beat volume, 57
BF, 1
Breathing tubes
 Warning, 1

C

Cadmium, 15
Calibration
 IBP, caution, 1
Calibration check
 mainstream CO₂, 57
 NIBP, 57
Calibration check, NIBP, 57
Carbon dioxide. *See* CO₂
Carbon monoxide, 57
Cascaded ECG, 57
Cautions, 1
Changing
 alarm setup, 29
 ECG setup, 57
 invasive pressure setup, 57

- monitor setup, 29
 - NIBP setup, 57
 - Respiration setup, 57
 - screen setup, 29
 - temperature setup, 57
 - time and date, 29
 - trend setup, 29
 - Charging batteries, 15
 - Checklist, 91
 - Cleaning, 15
 - airway accessories, 15
 - ECG cables, 15
 - invasive pressure, 15
 - NIBP Cuff, 15
 - NIBP hose, 15
 - Pulse oximetry, 15
 - temperature probes, 15
 - CO₂, 57
 - checklist, 91
 - cleaning the accessories, 15
 - CO₂ waveform, 57
 - Collecting Data, 29
 - Combine Pressures, 29
 - Combined pressures, 57
 - Compensation, N₂O and O₂, 57
 - ComWheel, 15
 - Configuration, 1
 - Connecting
 - mainstream CO₂ sensor, 57
 - Connectors
 - patient cables, 15
 - Continuous NIBP measurement, 57
 - Contrl, 57
 - CS/3 monitors, 29
 - Cycling, NIBP, 57
- D**
- Data**
- collecting, 29
 - entering patient data**, 29
- DataCard, 29
- Date, 29
- Def sync signal, 91
- Default, 29
 - alarm limits, 29
 - settings, 29
- Defaults
 - returning to, 29
- Defibrillator-proof, 1
- Degree of protection against harmful ingress of water, 1
- Description
 - patient cable connectors, 15
 - rear panel, 15
 - screen, 15
- Detection limits**
respiration, 57
- Digit Fields, 29
- Discarding the monitor, 1
- Disinfecting, 15
- Display, 15
- Disposal, 1
- DURASENSOR, 57
- DURA-Y, 57
- Dust filter
 - cleaning, 15
- Dyshemoglobins, 57
- E**
- ECG, 57
 - adjustments, 57
 - applying electrodes, 57
 - checklist, 91
 - electrodes, 57
 - selecting lead, 57
- Electrical interference, respiration, 57
- Electrodes, 57
- Electrosurgery, 57
 - Warning, 1, 57
- End of the Day, 15
- Entering name, 29
- Erasing
 - trend, 29
- Erasing Trend Data, 29

F

Flash memory card, 29
Freeze, 15

G

General alarm pattern, 29
Getting started, 15
Glutaraldehyde, 15
Graphic trends, 29
Grid, in ECG display, 57

H

Heart rate source, 57
Heavy metal waste, 15
Hemoglobin, 57
Hepatitis, 15
HIV, 15
Hospital grade, 1
HR source, 57

I

ID, 29
IEC codes, ECG electrodes, 57
IEC-601-1, 1
Impedance respiration, 57
In-Between Patients, 15
Inflation limits, 57
Information Centre, 29
Infrared light, 57
Install/Service, 29
Installing, 1
 configuration, 1
 monitor on the rail, 1
 network, 1
 power adapter, 1
 printer, 29
Intended Purpose, 1
Intermittent Mechanical Ventilation, 57
Intervals, NIBP measurement, 57
Invasive blood pressure, 57
 checklist, 91
 settings, 57

 zeroing transducer, 57
IPX-class, 1
ISO alarm pattern, 29
Isolating transformer, 1

K

Keys, 15

L

Labels
 invasive blood pressure, 57
 temperature, 57
Limitations
 Respiration measurement, 57
Local printing, 29
Low dead-space adapter, 57

M

Magnetic resonance imaging (MRI)
 Warning, 1
Mainstream CO₂, 57
Maintaining
 batteries, 15
Maintenance, 91
Measuring limitations
 Respiration, 57
Measuring Principle
 invasive blood pressure, 57
 NIBP, 57
 pulse oximetry, 57
Monitor Setup, 29
Monitor-to-Monitor Communication, 29
MRI
 Warning, 1
Multi View, 29

N

Name, patient's, 29
Nellcor Compatible, 57
Nellcor sensors, pulse oximetry, 57
Network, 29
 installing, 1

- NIBP, 57
 - checklist, 91
 - double check, 57
 - settings, 57
 - setup, 57
- Ni-Cd, 15
- N-LDATA, 29
- N-LDNET, 29
- N-LNET, 29
- Non-invasive blood pressure, 57
- Normal Screen, 15
- Numerical fields, 29
- Nurse Call, 29
 - disabling, 29
- Nurse call signal, 91

- O**
- On/standby, 15
- Oscillometric principle, 57
- Output signals, 91
- OXIBAND, 57
- OXICLIC, 57
- OXISENSOR II, 57
- Oxygen saturation, 57

- P**
- Pacemaker
 - displaying, 57
 - monitoring patients, 57
 - Warning, 1
- Paediatric mainstream adapter, 57
- Paper speed, 29
- Partial pressure, 57
- Patient Data**, 29
- Patient ID**, 29
- Patient View, 29
- Permanent settings, 29
- Placing
 - monitor, 1
- Placing Electrodes, 57
- Plethysmographic
 - Scale, 57
 - Plethysmographic waveform, 57
- Power adapter, 1
 - for transport vehicles, 1
- Preset alarm limits, 29
- Pressure
 - combined waveforms, 29
 - invasive blood, 57
 - non-invasive blood, 57
 - partial, 57
- Printing, 29
 - A4, 29
 - letter size, 29
 - local, 29
 - printer installation, 29
 - trends, 29
- Priorities of alarms, 29
- Problem-solving, 91
- Protective case, 1
- Pulse oximetry, 57
 - Alternative, 57
 - applying sensors, 57
 - checklist, 91
 - selecting sensor, 57
 - settings, 57
- Pulse rate, 57
- Pulse Search, 57

- R**
- Rear Panel, 15
- Recorder, 29
 - adding paper, 29
 - setup, 29
 - start on alarms, 29
- Recording
 - alarms automatically, 29
 - trends, 29
 - waveforms, 29
- Recycling, 1
- Regular checks, 91
- Reminder volume, 29
- Resetting all, 29
- Resolution

-
- trend, 29
 - Respiration, 57
 - Measuring limitations, 57
 - Respiration rate, 57
 - Respiration rate source, 57
 - Returning to defaults, 29
 - Rotating wheel, 15
 - S**
 - S/D, 29, 57
 - Safety Symbols, 1
 - Save as Defaults, 29
 - Scale
 - Automatic Plethysmographic, 57
 - CO₂, 57
 - Pleth, 57
 - Scaling
 - ECG, 57
 - invasive blood pressure, 57
 - Screen, 15
 - Screen setup, 29
 - Selecting
 - ECG lead, 57
 - heart rate source, 57
 - paper size, 29
 - parameters for display, 29
 - printer, 29
 - pulse oximetry sensor, 57
 - temperature unit, 57
 - Setting
 - alarm volume, 29
 - screen layout, 29
 - time and date, 29
 - Signals
 - defibrillator synchronisation, 91
 - nurse call, 91
 - Silencing alarms, 29
 - SpO₂, 57
 - Nellcor sensors, 57
 - response, 57
 - Spont, 57
 - Spontaneous
 - Breathing, 57
 - Starting a case, 29
 - STAT mode, 57
 - Steam autoclave, 15
 - Sterilization, 15
 - Stopping a case, 29
 - Sub menu, 1
 - Sweep speed
 - CO₂, 57
 - invasive pressure, 57
 - Symbols, 1
 - battery status, 15
 - T**
 - Temperature
 - checklist, 91
 - setup, 57
 - unit, 57
 - Testing Temperature, 57
 - Thermal paper, 29
 - Thick waves, 29
 - Time, 29
 - Transducer
 - Oxygen, 57
 - Transducer kit, 57
 - Transport
 - power adapter, 1
 - Trends, 29
 - changing page, 29
 - erasing, 29
 - setup, 29
 - viewing graphic, 29
 - viewing numerical, 29
 - Troubleshooting, 91
 - Tuberculosis, 15
 - Turning Audible Alarms Off/On, 29
 - Type BF, 1
 - Type of protection against electrical shock,
 - 1, 15
 - U**
 - Unit

CO₂, 57
Unit conversions, CO₂, 57
Unpacking, 1
Using
 data card, 29
 Network, 29

V

Vasoconstrictive drugs, 57
Venous Stasis, 57
Ventilation mode, 57
Viewing Graphic Trends, 29
Viewing Numerical Trend, 29

W

Warnings, 1
washing machine, 15
Waveforms
 displaying, 29
 invasive blood pressure, 57
 scaling ECG, 57
 scaling plethysmographic, 57
 sweep speed, 57
 thick waves, 29

Z

Zeroing the transducer, 57