



Operator's Manual

HAMILTON-C3

REF 160005

Software version 2.0.x
624446/03 | 2017-05-12

CE 0197

HAMILTON-C3 Operator's Manual

May 2017
624446/03

© 2017 All rights reserved. Printed in Switzerland.

No part of this publication may be reproduced, stored in a database or retrieval system, or transmitted in any form or by any means, electronic, mechanical, or by photocopying, recording, or otherwise, without prior written permission of Hamilton Medical AG.

This document may be revised, replaced, or made obsolete by other documents by Hamilton Medical AG at any time and without notice. Ensure that you have the most current applicable version of this document; if in doubt, contact the technical support department of Hamilton Medical AG, Switzerland. While the information set forth herein is believed to be accurate, it is not a substitute for the exercise of professional judgment.

Nothing in this document shall limit or restrict in any way Hamilton Medical AG's right to revise or otherwise change or modify the equipment (including its software) described herein, without notice. In the absence of an express, written agreement to the contrary, Hamilton Medical AG has no obligation to furnish any such revisions, changes, or modifications to the owner or user of the equipment (including software) described herein.

The equipment must be operated, serviced, or upgraded only by trained professionals. Hamilton Medical AG's sole responsibility with respect to the equipment and its use is as stated in the limited warranty provided in the operator's manual.

Hamilton Medical AG shall not be liable for any loss, cost, expense, inconvenience, or damage that may arise out of misuse of the product, or if non-Hamilton Medical AG parts were used when replacing parts, or if serial numbers were amended, deleted, or removed.

If returning parts to Hamilton Medical AG, be sure to use the standard Hamilton returned goods authorization (RGA) procedure. Disposal of parts shall follow all local, state, and federal regulation with respect to environmental protection.

Product and company names mentioned herein may be the trademarks and/or registered trademarks of their respective owners.

Hamilton Medical AG will make available, on request, circuit diagrams, component parts lists, descriptions, calibration instructions, or other information that will assist appropriately trained personnel to repair those parts of the equipment designated by Hamilton Medical AG to be repairable.

Manufacturer

Hamilton Medical AG
Via Crusch 8
CH-7402 Bonaduz
Switzerland

Phone: (+41) 58 610 10 20

Fax: (+41) 58 610 00 20

info@hamilton-medical.com

www.hamilton-medical.com

Conventions used in this guide

WARNING

A **WARNING** alerts the user to the possibility of injury, death, or other serious adverse reactions associated with the use or misuse of the device.

CAUTION

A **CAUTION** alerts the user to the possibility of a problem with the device associated with its use or misuse, such as device malfunction, device failure, damage to the device, or damage to other property.

NOTICE

A **NOTE** emphasizes information of particular importance.



Applies only when the Neonatal option is installed.

- Button and tab names are shown in a **bold** font.
- In this document, the screen diagrams may not exactly match what you see on your display, depending on the options you have installed and your exact ventilator model. However, the window and tab names, as well as their general location are the same.

HAMILTON-C3 user documentation

To download the latest version of this manual or other documents, visit the MyHamilton website:

<https://www.hamilton-medical.com/MyHamilton>

HAMILTON-C3 software information

The software version for the HAMILTON-C3 is visible in the System -> Info window. The software version should match the version on the title page of this manual. See Section 3.3.1 for details.

Intended use

The HAMILTON-C3 ventilator is intended to provide positive pressure ventilatory support to adults and pediatrics and optionally infants and neonates.

Intended areas of use:

- In the intensive care ward, intermediate care ward, emergency ward, long term acute care hospital or in the recovery room
- During transfer of ventilated patients within the hospital

The HAMILTON-C3 ventilator is a medical device intended for use by qualified, trained personnel under the direction of a physician and within the limits of its stated technical specifications.

WARNING

- (*USA only*): INTELLiVENT-ASV not available in the USA.
- (*USA only*): High flow oxygen therapy not available in the USA.

⚠ CAUTION

(USA only): Federal law restricts this device to sale by or on order of a physician.

General cautions and notes

⚠ WARNING

Modifications to the device are not permitted.

General operation notes

- The use of this equipment is restricted to one patient at a time.
- Additional information about installing the medical equipment, as well as additional technical information, is provided in the *Service Manual*.
- If there is visible damage to any part of the ventilator, do not use the device. Technical service is required.
- The intended patient population ranges from neonatal patients with 0.2 kg to 30 kg body weight to pediatric patients with 30 cm height (3 kg ideal body weight) up to adults up to 250 cm height (139 kg ideal body weight). The minimum tidal volume delivered shall be equal to or greater than 20 ml for adults/pediatrics, 2 ml for neonates.
- The displays shown in this manual may not exactly match what you see on your own ventilator.
- Familiarize yourself with this operator's manual before using the ventilator on a patient.

- Do not simultaneously touch conductive components (for example, the USB port) or conductive parts of the ventilator enclosure and the patient.
- Displayed information that is ghosted is not active and may not be selected.
- Dashes displayed in place of monitored data indicate that valid values are not yet available or do not apply.
- If a ventilator control does not respond when selected by touch or by the turn of a dial, the control is not active in this particular instance or the function is not implemented.

Monitoring and alarms

- The HAMILTON-C3 is not intended to be a comprehensive vital sign monitor for patients on life-support equipment. Patients on life-support equipment should be appropriately monitored by qualified medical personnel and suitable monitoring devices. The use of an alarm monitoring system does not give absolute assurance of warning for every type of issue that may arise with the ventilator. Alarm messages may not exactly pinpoint a problem; the exercise of clinical judgment is necessary.
- An alternative means of ventilation must be available whenever the ventilator is in use. If a fault is detected in the ventilator or its life-support functions are in doubt, disconnect the HAMILTON-C3 from the patient and immediately start ventilation with such a device (for example, a resuscitation bag), using PEEP and/or increased oxygen concentration when appropriate. The ventilator must be removed from clinical use and serviced by a Hamilton Medical authorized service engineer.

-
- It is recommended that additional independent monitoring devices be used during mechanical ventilation. The operator of the ventilator must still maintain full responsibility for proper ventilation and patient safety in all situations.
 - Do not silence the audible alarm when leaving the patient unattended.
 - Do not use the exhaust port of the expiratory valve for spirometry. Due to the HAMILTON-C3's base flow, the exhaust gas output is larger than the patient's actual exhaled volume.
 - Do not put a vessel filled with a liquid on the ventilator. If a liquid enters the product, a fire and/or electric shock may occur.
 - In case of fire, immediately secure the patient's ventilatory needs, switch off the ventilator, and disconnect it from its gas and electrical sources.
 - Do not use if primary power source cables are damaged.
 - To ensure that toxic constituents are not entrained into the breathing gas ventilate the patient with 100% O₂.

Service and testing

Fire and other hazards

- To reduce the risk of fire or explosion, do not place the ventilator in a combustible or explosive environment (for example, around flammable anaesthetics or other ignition sources) or insufficiently ventilated areas. Do not use it with any equipment contaminated with oil or grease. Highly compressed oxygen together with flammable sources could lead to spontaneous explosions.
- To minimize the risk of fire, do not use high-pressure gas hoses that are worn or contaminated with combustible materials like grease or oil.
- The HAMILTON-C3 can be used in an oxygen-enriched environment. To reduce the risk of fire, use only breathing circuits intended for use in oxygen-enriched environments. Do not use antistatic or electrically conductive tubing.
- To ensure proper servicing and to prevent possible physical injury, only Hamilton Medical authorized service personnel should attempt to service the ventilator.
- To reduce the risk of electrical shock, disconnect electrical power from the ventilator before servicing. Be aware that battery power remains even after the mains is disconnected. Be aware that if the power switch is off, some parts still carry high voltage.
- Do not attempt service procedures other than those specified in the service manual.
- Use replacement parts supplied by Hamilton Medical only.
- Any attempt to modify the ventilator hardware or software without the express written approval of Hamilton Medical automatically voids all warranties and liabilities.
- The preventive maintenance program requires a general service every 5000 hours or yearly, whichever comes first.

- To ensure the ventilator's safe operation, always run the preoperational check before using the ventilator on a patient. If the ventilator fails any tests, remove it from clinical use immediately. Do not use the ventilator until necessary repairs are completed and all tests have passed.
- The manufacturer can only be responsible for the safety, reliability, and performance of the ventilator if all of the following requirements are met:
 - Appropriately trained personnel carry out assembly operations, extensions, readjustments, modifications, maintenance, or repairs.
 - The electrical installation of the relevant room complies with the appropriate requirements.
 - The ventilator system is used in accordance with the operator's manual.

Electromagnetic susceptibility

WARNING

MR UNSAFE. Keep away from magnetic resonance imaging (MRI) equipment. The HAMILTON-C3 poses unacceptable risks to the patient, medical staff, or other persons within the MR environment.

The HAMILTON-C3 complies with the IEC 60601-1-2 EMC (Electromagnetic Compatibility) Collateral Standard. The HAMILTON-C3 needs special precautions regarding EMC and needs to be installed and put into service according to the EMC information provided in the HAMILTON-C3 EMC Declarations (PN 624895).

Portable and mobile RF communications equipment can affect the HAMILTON-C3 and all medical electrical equipment.

General standards and approvals

NOTICE

Where standards are mentioned, the HAMILTON-C3 complies with the versions listed in Table 1.

Table 1 Standards and approvals, valid versions

IEC 60601-1:2005/A1:2012
ANSI/AAMI ES60601-1:2005/(R)2012
CAN/CSA-C22.2 No. 60601-1:14
IEC 60601-1-2:2007
ISO 80601-2-12:2011 + Cor.:2011
ISO 80601-2-55:2011
IEC 61000-3-2:2005
IEC 61000-3-3:2008
IEC 61000-4-2:2008
IEC 61000-4-3:2006 + A1:2007+A2:2010
IEC 61000-4-4:2004
IEC 61000-4-5:2005
IEC 61000-4-6:2003+A1:2004+A2:2006
IEC 61000-4-8:2009
IEC 61000-4-11:2004
EN ISO 5359:2008 + A1: 2011
EN ISO 13485:2012/AC:2012
IEC 60950-1:2005 + AMD1:2009 + AMD2:20013

Table 1 Standards and approvals, valid versions

ISO 15883-1:2006+A1:2014
ISO 15883-2:2006
ISO 15883-3: 2006
ISO 15883-4:2008
ISO 11607-1: 2006 + AMD1:2014
EN ISO 9001:2008
EN ISO 5356-1:2004
ISO 4135:2001

For further Information see Section A.11.

Units of measure

NOTICE

This manual indicates pressure in cmH₂O and length in cm.

On the HAMILTON-C3, pressures are indicated in cmH₂O, mbar, or hPa. Hectopascals (hPa) are used by some institutions instead. Since 1 mbar equals 1 hPa, which equals 1.016 cmH₂O, the units may be used interchangeably. Length is indicated in cm or inches.

Disposal

All parts removed from the device must be considered contaminated and pose infection risk. Dispose of all parts removed from the device according to your institution's protocol. Follow all local, state, and federal regulations with respect to environmental protection, especially when disposing of the electronic device or parts of it (for example, oxygen cell, batteries).

Year of manufacture

The year of manufacture is shown on the serial number label on the HAMILTON-C3 ventilation unit.

Preface	5
Chapter 1 General information	21
1.1 Overview	22
1.2 Functional description	23
1.2.1 System overview	23
1.2.2 Gas supply and delivery	24
1.2.3 Gas monitoring with the flow sensor	25
1.3 Physical description	26
1.3.1 Breathing circuits and accessories	26
1.3.2 Ventilator unit	26
1.3.3 Main display	32
1.4 Symbols used on device labels and packaging	35
Chapter 2 Preparing for ventilation	39
2.1 Introduction	40
2.2 Connecting the humidifier	41
2.3 Installing the patient breathing circuit	41
2.4 Using a filter in the breathing circuit	42
2.4.1 Working with the expiratory valve	43
2.4.2 Selecting the breathing circuit	44
2.4.3 Assembling the patient breathing circuit	44
2.4.4 Positioning the breathing circuit	48
2.5 Installing the pneumatic nebulizer	48
2.6 Setting up CO2 monitoring	49
2.6.1 CO2 mainstream measurement	50
2.6.2 CO2 sidestream measurement	52
2.7 Setting up the SpO2 sensor	53
2.8 Installing the Aerogen Pro nebulizer	54
2.9 Connecting to a power source	54
2.9.1 Connecting to AC power	54
2.9.2 Connecting to DC power	54
2.10 About the batteries	54
2.11 Connecting the oxygen supply	56
2.11.1 Using a low-pressure oxygen supply	57
2.11.2 Connecting the oxygen supply to the ventilator	57
2.11.3 Selecting the oxygen source type	58
2.12 Working with the trolley	59
2.12.1 Installing the patient tubing support arm	59

2.12.2	Preparing the trolley for intrahospital transport	59
2.13	Connecting to an external device	60
2.14	Turning on the ventilator	60
2.15	Turning off the ventilator	61
2.16	Display navigation guidelines	61
Chapter 3	Tests, calibrations, and tools	63
3.1	Overview	64
3.2	Running the preoperational check	64
3.3	System functions	66
3.3.1	Info: Viewing device-specific information	66
3.3.2	Tests & calib: Running the tightness test and calibrations	66
3.3.3	Enabling/disabling O2, CO2, and/or SpO2 monitoring	71
3.3.4	Setting day and night display brightness	72
3.3.5	Setting date and time	73
3.4	Tools	73
3.4.1	Copying event log data to a USB memory device	73
3.5	Alarm tests	74
3.5.1	High pressure	74
3.5.2	Low minute volume	74
3.5.3	Low oxygen alarm	75
3.5.4	Disconnection on patient side	75
3.5.5	Loss of external power	75
3.5.6	Exhalation obstructed	75
3.5.7	Apnea	75
Chapter 4	Ventilator settings	77
4.1	Overview	78
4.2	Patient grouping	78
4.3	Quick setup settings	78
4.4	Patient setup	79
4.4.1	Viewing patient ventilation time	81
4.5	Setting the ventilation mode	82
4.5.1	Working with high flow oxygen therapy	83
4.6	Specifying mode settings	85
4.6.1	Changing parameter settings	85
4.6.2	Changing parameter settings with mode change	87

4.6.3	About apnea backup ventilation	88
4.6.4	Working with tube resistance compensation (TRC)	89
4.6.5	Accessing patient settings during ventilation	91
4.6.6	Control parameter settings	92
4.7	Working with alarms.	99
4.7.1	Setting alarm limits	99
4.7.2	Adjusting alarm loudness (volume)	100
4.7.3	Buffer: Viewing alarm information and on-screen help	101
4.7.4	Table of alarm limit settings	101
Chapter 5	Neonatal ventilation	105
5.1	Overview	106
5.2	Setting up for neonatal ventilation	106
5.2.1	Setting the patient group and weight	106
5.2.2	Selecting the ventilation mode	108
5.2.3	Setting up the breathing circuit	108
5.2.4	Performing tests and calibrations	113
5.2.5	Performing the preoperational check	115
5.3	Ventilation modes for neonates	116
5.4	Parameters for neonatal ventilation.	116
5.4.1	Weight	117
5.4.2	TI max	117
5.4.3	P-ramp	117
5.5	Alarms for neonatal ventilation	117
5.5.1	Volume-related alarms, Vt and ExpMinVol	118
5.6	O2 enrichment for neonates	118
Chapter 6	Monitoring ventilation.	119
6.1	Overview	120
6.2	Viewing numeric patient data	121
6.2.1	About the main monitoring parameters (MMP)	121
6.2.2	Viewing patient data in the Monitoring window	121
6.3	Viewing graphical patient data	122
6.3.1	About graphic types	124
6.3.2	Waveforms	124
6.3.3	Dynamic Lung	129
6.3.4	Vent Status	129

6.3.5	ASV Graph	129
6.4	Trends	130
6.4.1	Displaying trends	130
6.5	Loops	131
6.5.1	Displaying loops	132
6.5.2	Storing loops	132
6.6	Table of monitored parameters	132
6.7	Freeze and cursor measurement	141
Chapter 7	Intelligent panels	143
7.1	Overview	144
7.2	Dynamic Lung panel	144
7.2.1	Displaying the Dynamic Lung	144
7.2.2	Tidal volume (Vt)	145
7.2.3	Compliance (Cstat)	145
7.2.4	Patient triggering: Muscle	145
7.2.5	Resistance (Rinsp): Bronchial tree	146
7.3	Vent Status panel	146
7.3.1	Displaying the Vent Status panel	148
7.4	ASV Graph panel	148
7.4.1	Displaying the ASV Graph	149
Chapter 8	Responding to alarms	151
8.1	Overview	152
8.2	Responding to an alarm	154
8.3	Alarm buffer	155
8.3.1	Accessing on-screen help for alarms	156
8.4	About the event log	157
8.5	Alarm troubleshooting table	158
Chapter 9	Special functions	175
9.1	Overview	176
9.2	Standby	176
9.3	Alarm silence	177
9.4	O2 enrichment	178
9.5	Suctioning maneuver	179
9.6	Manual breath	179
9.7	Inspiratory and expiratory hold	180
9.7.1	Inspiratory hold	180
9.7.2	Expiratory hold	180

9.8	Nebulizer	181
9.9	Print screen	182
9.10	Screen Lock/unlock	182
Chapter 10	P/V Tool	183
10.1	Overview	184
10.1.1	General safety information	184
10.1.2	Conditions for use	185
10.1.3	Indications for use	185
10.1.4	Contraindications for use	185
10.2	About the P/V Tool window	185
10.3	Using the P/V Tool	187
10.3.1	Opening the P/V Tool	187
10.3.2	Adjusting the control settings	187
10.4	Performing a P/V Tool maneuver	189
10.5	Viewing data	189
10.5.1	Choosing the data to display	189
10.5.2	Numerical data	192
10.5.3	Analyzing the data	192
10.5.4	Using reference curves	192
10.6	Performing a recruitment maneuver	193
10.7	Closing the P/V Tool	193
Chapter 11	Maintenance	195
11.1	Overview	196
11.2	Cleaning, disinfection, and sterilization	196
11.2.1	General guidelines for cleaning	197
11.2.2	General guidelines for disinfection	198
11.3	Preventive maintenance	199
11.3.1	Servicing the air intake and fan filters	201
11.3.2	Working with the battery	202
11.3.3	Replacing the oxygen cell	204
11.4	Repacking and shipping	205
Chapter A	Specifications	207
A.1	Physical characteristics	208
A.2	Environmental requirements	209
A.3	Pneumatic specifications	210
A.4	Electrical specifications	211
A.5	Control settings	212

A.6	Monitored parameters	219
A.7	Alarms	224
A.8	Configuration specifications	227
A.9	Ventilator breathing system specifications.	229
A.10	Technical performance data	230
A.10.1	Accuracy testing	232
A.10.2	Essential performance	232
A.11	Standards and approvals.	233
A.12	Warranty	234
A.13	Miscellaneous.	235
Chapter B	Ventilation modes.	237
B.1	Overview	238
B.2	The aims of ventilation	239
B.3	Ventilation modes.	239
B.3.1	Breath timing options	242
B.4	(S)CMV mode	243
B.5	APVcmv / (S)CMV+ mode	246
B.6	SIMV mode	248
B.7	APVsimv / SIMV+ mode	250
B.8	PCV+ mode	252
B.9	PSIMV+ mode	254
B.10	PSIMV+ mode with PSync	256
B.11	DuoPAP mode	258
B.12	APRV mode	260
B.13	SPONT and NIV modes	262
B.14	NIV-ST mode	264
B.15	nCPAP-PS mode	266
B.15.1	Contraindications for use	266
B.16	High flow oxygen therapy (HiFlowO2)	268
B.17	ASV mode	270
B.18	INTELLiVENT-ASV mode	272
B.19	Safety mode/therapy	273
B.19.1	Safety mode/therapy	273
B.19.2	Ambient state	273
Chapter C	ASV, Adaptive Support Ventilation	275
C.1	Overview	276
C.1.1	Indications for use	276

C.1.2	Contraindications for use	276
C.2	ASV and ASV 1.1	276
C.2.1	Differences between ASV and ASV 1.1	276
C.3	Setting up ASV	276
C.4	Clinical use of ASV	277
C.4.1	Compensation for changes in apparatus dead space	279
C.5	Ventilating with ASV	279
C.5.1	Maintaining adequate ventilation	279
C.5.2	Reviewing alarm settings	280
C.5.3	Monitoring ASV	280
C.6	Weaning	282
C.7	Detailed functional description of ASV	282
C.7.1	Normal minute ventilation	282
C.7.2	Targeted minute ventilation	283
C.7.3	Lung-protective rules strategy	283
C.7.4	Optimal breath pattern	285
C.7.5	Dynamic adjustment of lung protection	287
C.7.6	Dynamic adjustment of optimal breath pattern	287
C.8	ASV technical data	288
C.8.1	ASV startup settings	290
Chapter D	NIV, noninvasive ventilation	291
D.1	Benefits of noninvasive ventilation	292
D.2	Required conditions for use	293
D.3	Contraindications	293
D.4	Potential adverse reactions	294
D.5	Selecting a patient interface	294
D.6	Control settings	294
D.7	Alarms	295
D.8	Monitored parameters	295
D.9	Additional notes about using noninvasive ventilation	296
D.10	References	297
Chapter E	CO₂ sensor option: Volumetric capnography	299
E.1	Overview	300
E.2	CO ₂ elimination (V'CO ₂)	300
E.3	End-tidal CO ₂ (PetCO ₂ and FetCO ₂)	301
E.4	Airway dead space (VDaw)	301

E.5	Alveolar minute ventilation (V'alv)	302
E.6	Capnogram shape	302
E.7	Formulas	304
E.8	References	304
Chapter F	Pneumatic diagram	305
Chapter G	Parts and accessories	307
G.1	Overview	308
Chapter H	Communications interface	315
H.1	Overview	316
H.2	About the communication protocols	316
H.3	Using the RS-232 interface	318
H.3.1	Connecting to a patient monitor	318
H.3.2	Changing the communication protocol	319
H.3.3	Connecting to a PDMS or computer	320
H.3.4	RS-232 connector pin assignments	321
H.4	Using the Nurse Call (6-pin) interface	321
H.4.1	Sending alarm signals to a remote device	322
H.4.2	Sending inspiratory: expiratory (I:E) timing signals	322
H.4.3	Nurse 6-pin connector pin assignments	322
Chapter I	Configuration	323
I.1	Overview	324
I.2	Accessing Configuration mode	324
I.3	Configuring general settings	324
I.3.1	Language: Selecting the default language	324
I.3.2	Selecting the default units of measure	325
I.3.3	Setting the minimum alarm loudness (volume)	325
I.4	Selecting breath timing, mode naming, and ASV version options	326
I.4.1	Setting breath timing options	326
I.4.2	Choosing the mode naming convention	326
I.4.3	Choosing the ASV version	327
I.5	Configuring the MMP display	327
I.6	Setup window (quick setup configuration)	327
I.6.1	Configuring individual setup settings	327
I.6.2	Selecting a default quick setup	330
I.6.3	SPO2 and INTELLiVENT configuration options	330

1.7	Copying configuration settings to a USB memory device	331
1.8	Configuring software and hardware options	331
1.8.1	Reviewing installed options	331
1.8.2	Adding software options	332
1.8.3	Enabling hardware options	333
1.8.4	Removing options	333
	Glossary	335
	Index	343

1

General information

1.1	Overview	22
1.2	Functional description	23
1.3	Physical description	26
1.4	Symbols used on device labels and packaging	35

1.1 Overview

The HAMILTON-C3 ventilator is intended to provide positive pressure ventilatory support to adults and pediatrics, and optionally infants and neonates.

Ventilation modes. This full-functioned intensive care ventilator offers a complete range of ventilation modes, including Hamilton Medical’s intelligent ventilation modes, Adaptive Support Ventilation (ASV®) and optionally, INTELLIVENT®-ASV, and High Flow Oxygen therapy (HiFlowO2).

For details about the modes, see Appendix B.

Monitoring. The HAMILTON-C3 offers a variety of monitoring capabilities. It displays monitored parameters as numbers. You can also see this data graphically, as a combination of real-time waveforms (curves), loops, trends, and special Intelligent Panels.

These Intelligent Panels include the Dynamic Lung, which shows the lung’s activity, and the Vent Status, which indicates the patient’s level of ventilator dependency.

The HAMILTON-C3’s monitored data is based on pressure and flow measurements collected by the Hamilton Medical proximal flow sensor, between the Y-piece and the patient, and on FiO2 measurements by the integrated oxygen monitor.

Alarms. The HAMILTON-C3’s operator-adjustable and non-adjustable alarms help ensure your patient’s safety.

User interface. The ventilator’s ergonomic design, including a 12.4-in color touch screen, press-and-turn knob, and keys, lets you easily access the ventilator settings and monitored parameters. You can tilt the display up to 45 degrees.

Customizability. You can customize the HAMILTON-C3 so that it starts up with institution-defined settings.

Power. The HAMILTON-C3 uses AC or DC power as its primary source. If the primary power source fails, the ventilator automatically switches to backup batteries.

Mounting variations. The HAMILTON-C3 includes a standard trolley, compact transport solution, and a shelf mount. The trolley has space for oxygen cylinders. With an adapter plate, the device can be mounted on a standard transport trolley.

Nebulization function. The nebulization function lets your HAMILTON-C3 power a pneumatic nebulizer connected to the nebulizer outlet. Pneumatic nebulization is disabled during neonatal ventilation.

Options

The following options are available for the HAMILTON-C3.

Option	Description
<i>Some options require additional hardware. Options are enabled in Configuration mode. Not all options are available in all markets.</i>	
Adult/pediatric support	Ventilation of adult and pediatric patients.
Neonatal support	Ventilation of infants and neonates starting from a tidal volume of 2 ml.
nCPAP-PS ventilation mode	Designed to apply nasal continuous positive airway pressure with additional pressure support for infants and neonates.
HiFlowO2	Provides a continuous flow of heated and humidified air and oxygen.

Option	Description
<i>Some options require additional hardware. Options are enabled in Configuration mode. Not all options are available in all markets.</i>	
P/V Pro Tool	The P/V Tool is a diagnostic and monitoring maneuver used to assess lung compliance.
INTELLiVENT-ASV	INTELLiVENT-ASV is an advanced ventilation mode to automatically regulate CO ₂ elimination and oxygenation for both passively and spontaneously breathing patients, based on both physiologic data from the patient and clinician-set targets.
CO ₂ sensor	Continuously monitors airway carbon dioxide and reports PetCO ₂ and inhaled/exhaled CO ₂ for display and alarm purposes.
SpO ₂ sensor	Continuously monitors pulse oximetry for display and alarm purposes. See <i>Pulse Oximetry Instructions for Use</i>
Communication interface	Provides a connection to a remote monitor, patient data management system (PDMS), or other computer system.
Nurse call	With the nurse call interface, the ventilator relays alarms and alarm messages to the nurse call system.

1.2 Functional description

The following sections describe the operation of the HAMILTON-C3 ventilator hardware.

1.2.1 System overview

The HAMILTON-C3 is an electronically controlled pneumatic ventilation system with an integrated air compressing system. It runs on AC or DC power with battery backup to protect against power failure or unstable power and to facilitate intra-hospital transport. The ventilator's pneumatics deliver gas, and its electrical systems control pneumatics, monitor alarms, and distribute power.

The user provides inputs to the HAMILTON-C3 microprocessor system through a touch screen, keys, and a press-and-turn knob. These inputs become instructions for the HAMILTON-C3's pneumatics to deliver a precisely controlled gas mixture to the patient. The ventilator receives inputs from the proximal flow sensor and other sensors within the ventilator. Based on this monitored data, the ventilator adjusts gas delivery to the patient. Monitored data is also displayed by the graphic user interface.

The ventilator's microprocessor system controls gas delivery and monitors the patient. The gas delivery and monitoring functions are cross-checked by an alarm controller. This cross-checking helps prevent simultaneous failure of these two main functions and minimizes the possible hazards of software failure.

A comprehensive system of visual and audible alarms helps ensure the patient's safety. Clinical alarms can indicate an abnormal physiological condition. Technical alarms, triggered by the ventilator's

self-tests including ongoing background checks, can indicate a hardware or software failure. In the case of some technical alarms, a special safety mode ensures basic minute ventilation while giving the user time for corrective actions. When a condition is critical enough to possibly compromise safe ventilation, the HAMILTON-C3 is placed into the ambient state. The inspiratory channel and expiratory valves are opened, letting the patient inspire room air through the inspiratory channel and exhale through the expiratory valve.

The HAMILTON-C3 has several means to ensure that safe patient or respiratory pressures are maintained. The maximum working pressure is ensured by the high pressure alarm limit. If the set high pressure limit is reached, the ventilator cycles into exhalation. The ventilator pressure cannot exceed 60 cmH₂O.

1.2.2 Gas supply and delivery

The HAMILTON-C3 uses room air and low- or high-pressure oxygen (Figure 1-1). The use of medical oxygen is mandatory. Air enters through a fresh gas intake port and is compressed together with the oxygen by the blower. Oxygen enters through a high¹- or low²-pressure inlet.

Figure 1-1 Gas delivery in the HAMILTON-C3

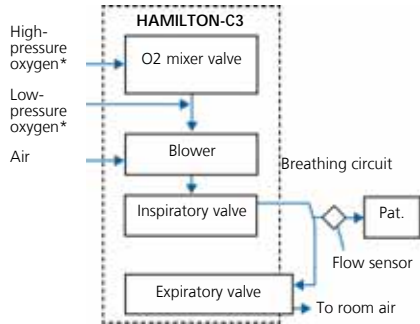

* Only one oxygen source (high or low) is required

Within the ventilator, the gas enters the ventilator's pneumatic system. If high-pressure oxygen is supplied, a mixer valve provides for the operator-set concentration. If low-pressure oxygen is supplied, the delivered oxygen concentration is determined by the flow of the source oxygen.

Gas is supplied to the patient via the inspiratory valve. The microprocessor controls the size of the inspiratory valve opening and the length of time it is open to meet the user settings.

The ventilator delivers gas to the patient through the inspiratory limb breathing circuit parts, which may include one or more of the following: inspiratory filter, flex tubes, humidification system, water traps, Y-piece, and flow sensor. An internal pneumatic nebulizer supplies the nebulizer flow.

Gas exhaled by the patient passes through the expiratory limb breathing circuit parts, including flex tubes, flow sensor, Y-piece, and expiratory valve cover and membrane. Gas is vented through the expiratory valve cover such that no exhaled gas comes into contact with any internal components of

1. High-pressure oxygen: Maximum allowed pressure, 600kPa
2. Low-pressure oxygen: Maximum allowed pressure, 600kPa / maximum allowed flow, 15 l/min

the ventilator. Measurements taken at the flow sensor are used in the pressure, flow, and volume measurements.

An oxygen cell (sensor) monitors the oxygen concentration of the gas to be delivered to the patient. This galvanic cell generates a voltage proportional to the partial pressure of oxygen in the delivered gas. This oxygen measurement is compensated for changes in pressure.

The operations of the blower and expiratory valve are coordinated to maintain system pressure levels.

1.2.3 Gas monitoring with the flow sensor

The HAMILTON-C3 accurately measures flow, volume, and pressure in the patient's airway with the Hamilton Medical flow sensor. This proximal flow sensor lets the ventilator sense even weak patient breathing efforts. Between its highly sensitive flow trigger and fast response time, the ventilator helps minimize the patient's work of breathing.

The flow sensor contains a thin, diamond-shaped membrane within the outer housing and has a pressure port on either side. The membrane allows bidirectional flow through its variable orifice.

Figure 1-2 Flow sensor (adult/pediatric)

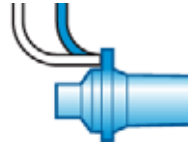

The area of the orifice changes depending on the flow rate. It opens progressively as the flow increases, creating a pressure drop across the orifice. The pressure difference is measured by a high-precision differential pressure sensor inside the ventilator. The pressure difference varies with flow (relationship determined during flow sensor calibration), so the patient's flow is determined from the pressure drop. The ventilator calculates volume from the flow measurements.

The flow sensor is highly accurate even in the presence of secretions, moisture, and nebulized medications. The ventilator flushes the sensing tubes with mixed gases (rinse flow) to prevent blockage.

1.3 Physical description

1.3.1 Breathing circuits and accessories

WARNING

To ensure proper ventilation operation, use only parts and accessories specified in Appendix G and in the product catalog, or that are specified as being compatible with this ventilator.

NOTICE

Pressure and volume measurement accuracy may be affected by using a breathing circuit with high resistance. Accuracy was tested with Hamilton Medical devices using the breathing circuits PN 281592 for neonates, and PN 260086 for adults and pediatrics.

Figure 1-3 shows the HAMILTON-C3 with its breathing circuit and accessories. Contact your Hamilton Medical representative for details on breathing circuits and accessories supplied by Hamilton Medical.

Figure 1-3 HAMILTON-C3 with accessories

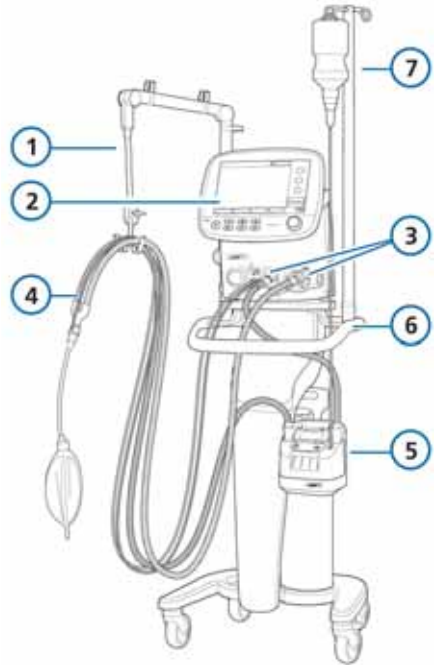



- | | |
|---------------------------------|----------------|
| 1 Support arm | 5 Humidifier |
| 2 Display and controls | 6 Trolley |
| 3 Breathing circuit connections | 7 Infusion arm |
| 4 Breathing circuit | |

1.3.2 Ventilator unit

Figures 1-4 through Figure 1-7 show the controls, indicators, and other important parts of the ventilator unit.

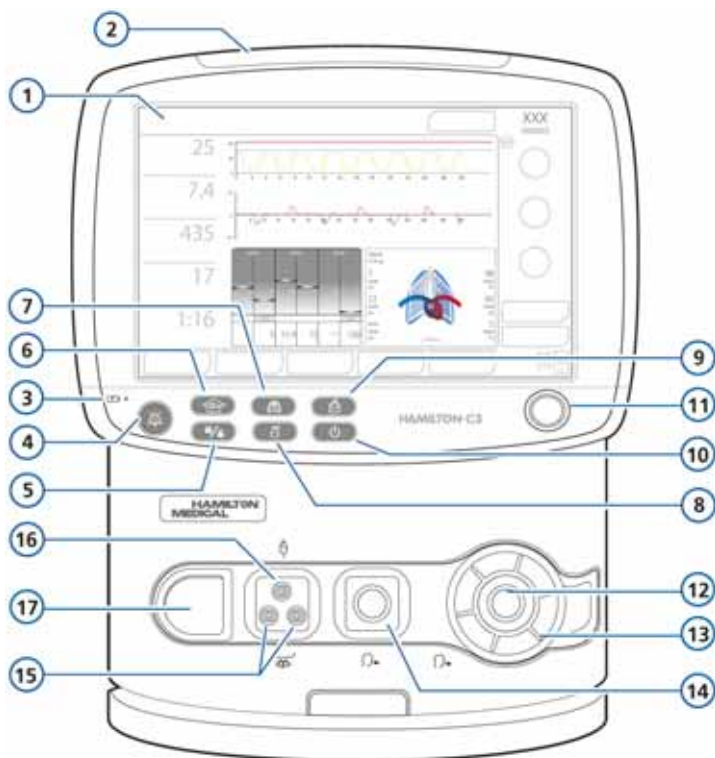
Figure 1-4 Front view



Item	Description
1	Display. Touch screen that provides access to measurements and controls.
2	Alarm lamp. Entire lamp lights when an alarm is active (flashing red = high-priority alarm, flashing yellow = medium-priority alarm, solid yellow = low-priority alarm).
3 	Battery charge indicator. Lit when the ventilator is connected to AC power or to > 20 V DC, even when the ventilator is turned off. The batteries are charging when the device is connected to primary power.

Item	Description
<p>4</p> 	<p>Alarm silence key. Silences the main ventilator audible alarm for 2 min. Press the key a second time to cancel the alarm silence. The key flashes red when an alarm is active but not muted. The key backlight is red while alarm silence is active. See Section 9.3.</p>
<p>5</p> 	<p>Screen lock/unlock key. Prevents inadvertent change of settings. See Section 9.10.</p> <p>When screen lock is active, the key backlight is green and the following items are inactive: touch screen, Press-and-turn knob, and the Power/Standby and Print screen keys.</p> <p>The following keys are active: Alarm silence, Manual breath, O2 enrichment, Nebulizer.</p>
<p>6</p> 	<p>O2 enrichment key. When active, the key backlight is green. See Section 9.4.</p> <p>Adults/Pediatric: Delivers 100% oxygen for 2 min. The actually applied oxygen concentration is displayed on the oxygen control (green). Push the key a second time or manually change the oxygen concentration (FiO2) to end enrichment.</p> <p>Neonatal: Delivers 125% of the last oxygen setting for 2 min. The backlit color changes to green and the currently applied oxygen concentration is displayed on the oxygen control. Push the key a second time or manually change the oxygen concentration (FiO2) to end enrichment.</p>
<p>7</p> 	<p>Manual breath key. Triggers a mandatory breath when pressed and released during exhalation. Triggers a prolonged inspiratory breath when held down during any breath phase. When active, the key backlight is green. See Section 9.6.</p>
<p>8</p> 	<p>Nebulizer on/off key. Activates pneumatic nebulizer, during the inspiration phase if high-pressure oxygen is connected. Nebulization stops automatically after 30 min. Turn it off earlier by pressing the key again. When active, the key backlight is green. See Section 9.8.</p>
<p>9</p> 	<p>Print screen key. Save a JPG file of the used current ventilator screen to a USB memory drive. The green indicator is lit while the device saves the image to the USB memory drive. See Section 9.9.</p>





Item	Description
10 	<p>Power/Standby key. Turns the ventilator on and off and accesses standby.</p> <p>To turn on the ventilator, press the key for ~3 s.</p> <p>To put the ventilator into standby, press and release the key, then touch Activate standby button on the display. For details, see Section 9.2.</p> <p>To turn off ventilator power, press the Power/Standby key and release. Touch the Activate standby key to confirm. Press the Power/Standby key again for > 3 s to power off the ventilator; or, if there is a technical fault, press and hold the key for > 10 s.</p> <p>The key backlight changes color depending on the ventilator state: During active ventilation, the key is white. When in standby, the key is green.</p>
11	<p>Press-and-turn (P&T) knob. Used to select and adjust ventilator settings. A green ring around the knob is lit when the ventilator is turned on.</p>
12 	<p>From patient port. To connect the expiratory limb of the patient breathing circuit and the expiratory valve.</p>
13	<p>Expiratory valve cover and membrane.</p>
14 	<p>To patient port. To connect the inspiratory filter and the inspiratory limb of the breathing circuit.</p>
15 	<p>Hamilton Medical flow sensor connectors. The blue tube goes to the blue connector. The clear tube goes to the white connector.</p>
16 	<p>Pneumatic nebulizer output connector. Port for pneumatic nebulizer. For details, see Section 9.8.</p>
17	<p>O2 cell with cover. To replace the O2 cell, see Section 11.3.3.</p>

Figure 1-5 Rear view



Item	Description
1	Serial number label
2	RS-232 connector. Must be covered during patient transport to protect device against water entry.
3	Fresh air intake and cooling fan vents, HEPA and dust filters (behind the cover). For details on replacing filters, see Chapter 11.
4	AC power cord with retaining clip
5	DC power connector
6	AC power receptacle
7	Low-pressure oxygen connector
8	High-pressure oxygen DISS or NIST inlet fitting
9	Communication board (optional). Offers one or more of the following options: CO2 monitoring, SPO2 monitoring, Nurse call port
10	RJ-45 Ethernet connector. For internal use only.

Figure 1-6 Side view, with battery door

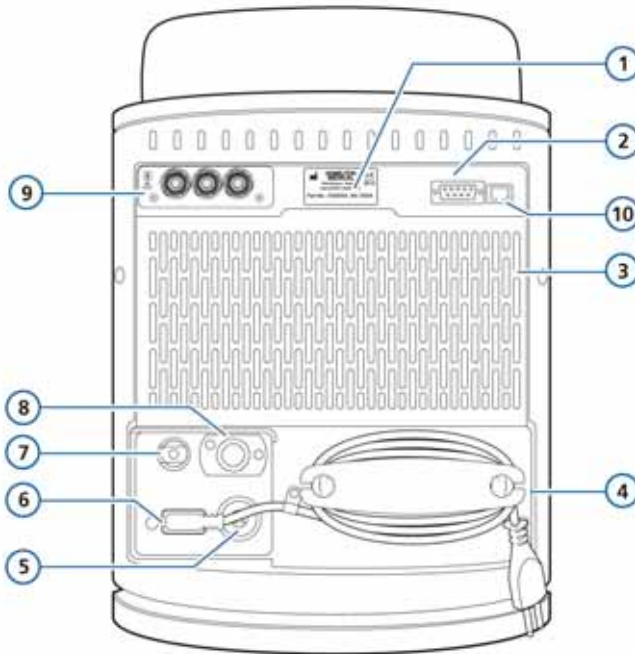
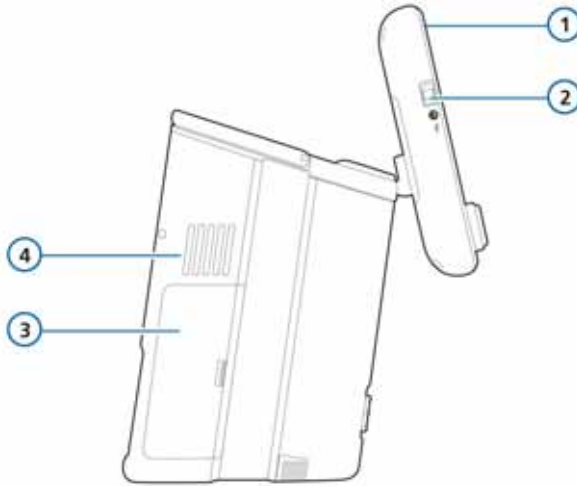



Item	Description
1	Adjustable-tilt monitor
2	 USB connector. Used by passive memory devices only, for software update, event log export, configuration setting export and import, and print screen. <p>WARNING!</p> <ul style="list-style-type: none"> • During transfer of a ventilated patient, to prevent water intake, the HAMILTON-C3 USB port must be covered with the plastic cover (included). • It is not allowed to use the USB port during transfer of a ventilated patient. • Not for use as a wireless plug-in connection, that is, not for use with dongles. No wireless connections are to be made using the USB port.
3	Battery door. The batteries are located inside the door.
4	Cooling air vent. Do not obstruct

Figure 1-7 Side view, with exhaust port

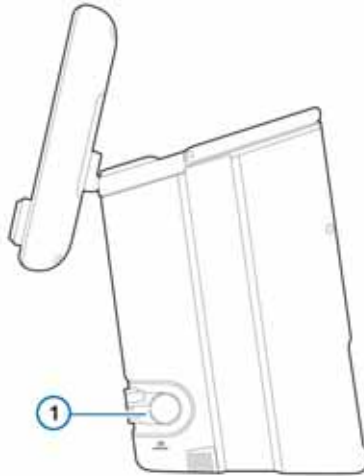

Item	Description
1	Expiratory valve exhaust port. Do not obstruct

EXHAUST

1.3.3 Main display

Directly access all the windows for mode, controls, alarms, and monitoring from the main display during normal ventilation.

Figure 1-8 Main display

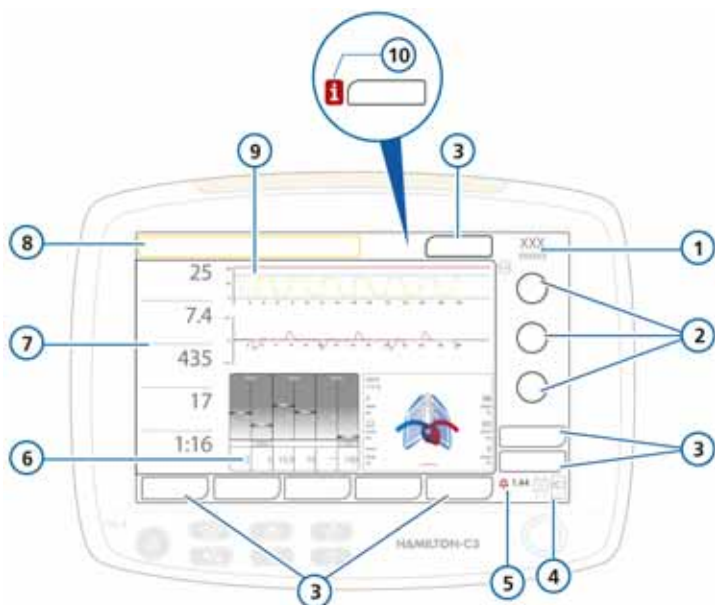

Item	Description
1	Active mode and patient group
2	Main controls. The most important controls. Touch the Controls button (3) to display all controls for the selected mode.
3	Window buttons (tabs). Open the associated windows.
4	Input power. Shows all available power sources. The framed symbol indicates the current source (AC = mains, DC = DC power supply, 1 = battery 1, 2 = battery 2). The green part of the battery symbol shows the level of battery charge, while the red shows the level of discharge.
5	Alarm silence indicator and countdown. Shows whether alarm silence has been activated, and displays the remaining silence time.
6	Graphic display. Shows a user-configurable selection of waveforms, trends, loops, and/or Intelligent panels (Dynamic Lung, Vent Status, ASV Graph)

Item	Description
7	Main monitoring parameters (MMP). Configurable list of monitored parameters. You can view all parameter values in the Monitoring window. MMPs change their colors when a corresponding alarm activates. The color reflects the priority of the alarm (red for high priority, yellow for medium or low priority).
8	Message bar. Displays color-coded alarm messages. If an alarm is active, touch the message bar to view the alarm buffer.
9	Pressure/time waveform. <ul style="list-style-type: none">• Shown by default, but can be changed.• The waveform shows the patient's breath cycles.• The red line is the Pmax high pressure alarm setting.• The blue line is the pressure limit, automatically 10 cmH2O below the Pmax alarm setting.• The pink triangles indicate the patient is triggering a breath.
10	Alarm indicator (i-icon). Indicates that there is information about alarms in the alarm buffer. Touch the i-icon to view the alarm buffer.

1.4 Symbols used on device labels and packaging

Table 1-1 Symbols used on device labels and packaging











Symbol	Definition
	Power/Standby key
	Manufacturer
	Date of manufacture
	Type B applied part (classification of medical electrical equipment, type B, as specified by IEC 60601-1)
	Type BF applied part (classification of medical electrical equipment, type BF, as specified by IEC 60601-1)
	Consult operator's manual. Refer to the operator's manual for complete information. This label on the device points the user to the operator's manual for complete information. In the operator's manual, this symbol cross-references the label.
	Symbol for "Caution". Applied parts not protected against defibrillation.
	CE Marking of Conformity, seal of approval guaranteeing that the device is in conformance with the Council Directive 93/42/EEC concerning medical devices
	Indicates the degree of protection against electric shock according to IEC 60601-1. Class II devices have double or reinforced insulation, as they have no provision for protective grounding.
	The TÜV NRTL mark with the indicators "C" and "US" means that the product complies with Canadian requirements and the requirements of US authorities for safety.
	Dispose according to Council Directive 2002/96/EC or WEEE (Waste Electrical and Electronic Equipment)

Table 1-1 Symbols used on device labels and packaging











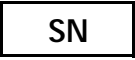









Symbol	Definition
	Serial number
	This way up at transport and storage
	Fragile, handle with care at transport and storage
	Keep dry at transport and storage
	Temperature limitations at transport and storage
	Humidity limitations at transport and storage
	Atmospheric pressure limitations at transport and storage
	Stacking limitations at transport and storage
	Recyclable materials
	Mass
IP21	Protected against dripping water and solid particles larger than 12.5 mm.
	HAMILTON-C3 poses unacceptable risks to the patient, medical staff, or other persons within the MR environment.
	Single use

Table 1-1 Symbols used on device labels and packaging

Symbol	Definition
	<p>Autoclavable.</p> <p>Autoclavable parts can be used inside an autoclave (for example, a steam autoclave) without damage. These parts withstand temperatures up to approximately 134°C. The correct way to reprocess autoclavable parts is described in the <i>Reprocessing Guide</i> provided by the manufacturer.</p> <p>Parts that Hamilton Medical terms as <i>autoclavable</i> can undergo autoclaving with steam sterilization without damage.</p>
	<p>Reusable.</p> <p>A reusable part is a medical device or part of a medical device that can be reused if it undergoes some sort of reprocessing between use on different patients. The correct way to reprocess reusable parts is described in the <i>Reprocessing Guide</i> provided by the manufacturer.</p> <p>Parts that Hamilton Medical terms as <i>reusable</i> cannot be autoclaved with steam sterilization.</p>
	<p>Applicable to neonatal patient group</p>
	<p>Applicable to pediatric patient group</p>
	<p>Applicable to adult patient group</p>
	<p>Applicable to neonatal/pediatric patient groups</p>
	<p>Applicable to pediatric/adult patient groups</p>
	<p>Applicable to all patient groups</p>

2

Preparing for ventilation

2.1	Introduction	40
2.2	Connecting the humidifier.	41
2.3	Installing the patient breathing circuit	41
2.4	Using a filter in the breathing circuit	42
2.5	Installing the pneumatic nebulizer	48
2.6	Setting up CO2 monitoring	49
2.7	Setting up the SpO2 sensor	53
2.8	Installing the Aerogen Pro nebulizer	54
2.9	Connecting to a power source.	54
2.10	About the batteries	54
2.11	Connecting the oxygen supply	56
2.12	Working with the trolley	59
2.13	Connecting to an external device.	60
2.14	Turning on the ventilator	60
2.15	Turning off the ventilator.	61
2.16	Display navigation guidelines.	61

2.1 Introduction

WARNING

- Additional equipment connected to medical electrical equipment must comply with the respective IEC or ISO standards (for example, IEC 60950-1 for data processing equipment). Furthermore, all configurations shall comply with the requirements for medical electrical systems (see IEC 60601-1, clause 16).
- Anybody connecting additional equipment to medical electrical equipment configures a medical system and is, therefore, responsible that the system complies with the requirements for medical electrical systems. Note that local laws take priority over the above-specified requirements. If you have questions about how to proceed, consult your Hamilton Medical representative or technical service department.
- In case of ventilator failure, the lack of immediate access to appropriate alternative means of ventilation can result in patient death.
- The ventilator must not be used in a hyperbaric chamber.
- Before beginning ventilation, ensure the O₂ cell is installed. See Section 11.3.3.
- Adding attachments or other components or subassemblies to the HAMILTON-C3 can change the pressure gradient across the HAMILTON-C3; these changes to the HAMILTON-C3 can adversely affect the ventilator performance.
- To prevent back pressure and possible patient injury, do not attach any parts not expressly recommended by Hamilton Medical to the expiration port of

the expiratory valve housing (for example, spirometers, tubes, or other devices).

- Use of accessories, transducers, and cables other than those specified or provided by the manufacturer of this equipment could result in increased electromagnetic emissions, or decreased electromagnetic immunity of this equipment, and result in improper operation.
- To prevent interrupted operation of the ventilator due to electromagnetic interference, avoid using it adjacent to or stacking other devices on it. If adjacent or stacked use is necessary, verify the ventilator's normal operation in the configuration in which it will be used.
- Portable RF communications equipment, including peripherals such as antenna cables and external antennas, should be used no closer than 30 cm (12 in) to any part of the HAMILTON-C3 ventilator, including cables specified by the manufacturer. Otherwise degradation of the performance of this equipment could result.
- The emissions characteristics of this equipment make it suitable for use in industrial areas and hospitals (CISPR 11, class A). If it is used in a residential environment (for which CISPR 11, class B is normally required) this equipment might not offer adequate protection to radio-frequency communication services. The user might need to take mitigation measures, such as relocating or reorienting the equipment.

- Correct function of the device may be impaired by the operation of high-frequency surgical equipment, micro-waves, shortwaves, or strong magnetic fields in close proximity.
- For important safety information about using the HAMILTON-C3 trolley, see Section 2.12.

⚠ CAUTION

- *Before using the ventilator for the first time, Hamilton Medical recommends that you clean its exterior and sterilize its components as described in Chapter 10.*
- *To electrically isolate the ventilator circuits from all poles of the primary power supply simultaneously, disconnect the power plug.*
- *To prevent possible patient injury, do not block the holes at the back and the side (cooling fan) of the ventilator. These holes are vents for the fresh air intake and the cooling fan.*

2.2 Connecting the humidifier

⚠ WARNING

- To prevent possible patient injury and possible water damage to the ventilator, make sure the humidifier is set to appropriate temperature and humidification settings.
- To prevent possible patient injury and equipment damage, do not turn the humidifier on until the gas flow has started and is regulated. Starting the heater or leaving it on without gas flow for prolonged periods may result

in heat build-up, causing hot air to be delivered to the patient. Circuit tubing may melt under these conditions. Turn the heater power switch off before stopping gas flow.

⚠ CAUTION

Regularly check the water traps and the breathing circuit hoses for water accumulation. Empty as required.

Connect a humidifier to the HAMILTON-C3 using the slide bracket on the trolley column. Prepare the humidifier as described in the manufacturer's operation manual.

2.3 Installing the patient breathing circuit

⚠ WARNING

- To minimize the risk of bacterial contamination or physical damage, handle bacteria filters with care.
- Make sure a HEPA filter is installed.
- For each new patient, always use a new or properly decontaminated breathing circuit.
- To reduce the risk of fire, use only breathing circuits intended for use in oxygen-enriched environments. Do not use antistatic or electrically conductive tubing.
- Only use approved CE-labeled consumables as accessories.

NOTICE

- Any bacteria filter, HMEF/HME, or additional accessories in the expiratory limb may substantially increase flow resistance and impair ventilation.

- To ensure that all breathing circuit connections are leak-tight, perform the tightness test every time you install a circuit or change a circuit part.
- Do not combine the neonatal CO₂ airway adapter and the adult flow sensor. Artefacts during the measurement are possible.
- When adding components to the Hamilton Medical breathing circuit configurations, do not exceed the inspiratory and expiratory resistance values of the ventilator breathing system as specified in Appendix A, as required by ISO 80601-2-12.
- Pressure and volume measurement accuracy may be affected by using a breathing circuit with high resistance. Accuracy was tested with Hamilton Medical devices using the breathing circuits PN 281592 for neonates, and PN 260086 for adults and pediatrics.

Connecting the adult/pediatric breathing circuit comprises the following steps. For neonatal ventilation, see Chapter 5.

	See
1. Using a filter in the breathing circuit	Section 2.4
2. Install the expiratory valve	Section 2.4.1
3. Select the appropriate breathing circuit and components	Section 2.4.2
4. Assemble the breathing circuit	Section 2.4.3
5. Adjust position of the breathing circuit	Section 2.4.4

	See
6. Perform any required tests (tightness test and calibrations) and the preoperational check	Chapter 3

2.4 Using a filter in the breathing circuit

WARNING

- **To prevent patient or ventilator contamination, always use a bacteria filter or HMEF/HME between the patient and the inspiratory port. If no inspiratory filter is used, the exhaled gas can contaminate the ventilator.**
- During ventilation, regularly check the breathing circuit filter for increased resistance and blockage.

CAUTION

- *The use of an expiratory filter can lead to a significant increase in expiratory circuit resistance. Excessive expiratory circuit resistance can compromise ventilation and increase patient work of breathing or AutoPEEP or both.*
- *Nebulization of drugs can cause an occlusion and increased resistance of the filter.*

NOTICE

Monitored parameters for increased expiratory resistance are not specific to the breathing circuit and may indicate increased patient airway resistance and/or increased resistance of the artificial airway (if used). Always check the patient and confirm adequate ventilation.

Inspiratory bacteria filter

To prevent patient or ventilator contamination, always connect a bacteria (inspiratory) filter or HMEF between the patient and the inspiratory port.

For neonatal patients, use a neonatal-pediatric bacteria (inspiratory) filter or HMEF.

If no inspiratory filter is used, the exhaled gas can contaminate the ventilator. If you are not using an inspiratory filter, and an exhalation obstructed alarm is generated, the ventilator may be contaminated. Have the ventilator serviced.

Expiratory bacteria filter

An expiratory filter is not required on the HAMILTON-C3, but you may use one according to your institution's protocol. It is not required because the expiratory valve design prevents internal ventilator components from contact with the patient's exhaled gas.

If you do use an expiratory filter, place it on the patient side of the expiratory valve cover. Monitor closely for increased expiratory circuit resistance.

An **Exhalation obstructed** alarm may also indicate excessive expiratory circuit resistance. If the **Exhalation obstructed** alarm occurs repeatedly, remove the expiratory filter immediately. If you otherwise suspect increased expiratory circuit resistance, remove the expiratory filter or install a new filter to eliminate it as a potential cause.

Figure 2-1 Connecting a bacteria filter (1)

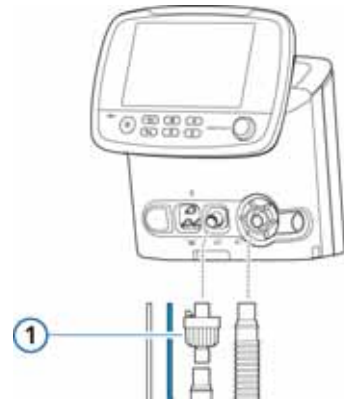

Heat and moisture exchanging filter (HMEF)

The HMEF is a passive humidification device together with a bacteria filter. Use an HMEF when ventilating with a coaxial breathing system.

Figure 2-2 Installing an HMEF/HME (1)

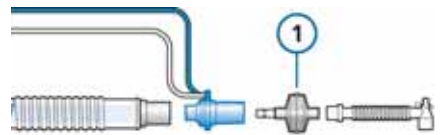

2.4.1 Working with the expiratory valve

NOTICE

Use only HAMILTON-C3 expiratory valve membranes.

To assemble/install the expiratory valve

1. Holding the expiratory valve housing (Figure 2-3), seat the silicone membrane onto the housing.

The metal plate must face up and be visible.

2. Position the housing and twist clockwise until it locks into place.

Figure 2-3 Installing the expiratory valve



To disassemble the expiratory valve

1. Holding the expiratory valve housing, remove the silicone membrane (1 in Figure 2-3) by lifting it up.

2.4.2 Selecting the breathing circuit

Select the correct breathing circuit parts for your patient from Tables 2-2 and 2-3 (when applicable).

 For neonatal ventilation, see Chapter 5.

Patient Group:	Pediatric	Adult
Patient height (cm)	30 to 150 (11 to 59 in)	> 130 (51 in)
IBW (kg)	3 to 42	> 30
Tracheal tube ID (mm)	3 to 7	≥ 5
Breathing circuit tube ID ¹ (mm)	15 to 22	15 to 22

Patient Group:	Pediatric	Adult
Flow sensor	Pediatric/ adult	Pediatric/ adult
CO2 airway adapter	Pediatric/ adult	Pediatric/ adult

1. When using coaxial breathing sets, follow the manufacturer's recommendations for each patient group.

Tracheal tube ID (mm)	CO2 airway adapter
> 4	Adult/pediatric

2.4.3 Assembling the patient breathing circuit

Assembling the adult/pediatric breathing circuit comprises the following steps:

		See
1	Connect the circuit	Figures 2-4 to 2-6
2	Connect the flow sensor	Section 2.4.3.2

2.4.3.1 Connecting the breathing circuit

Figures 2-4 through 2-6 show typical adult/pediatric breathing circuits. For neonatal ventilation, see Chapter 5.

For ordering information, contact your Hamilton Medical representative. Follow the specific guidelines for the different parts.

Connect the components as appropriate for your patient.

Figure 2-4 Dual-limb breathing circuit with humidifier (adult/pediatric)

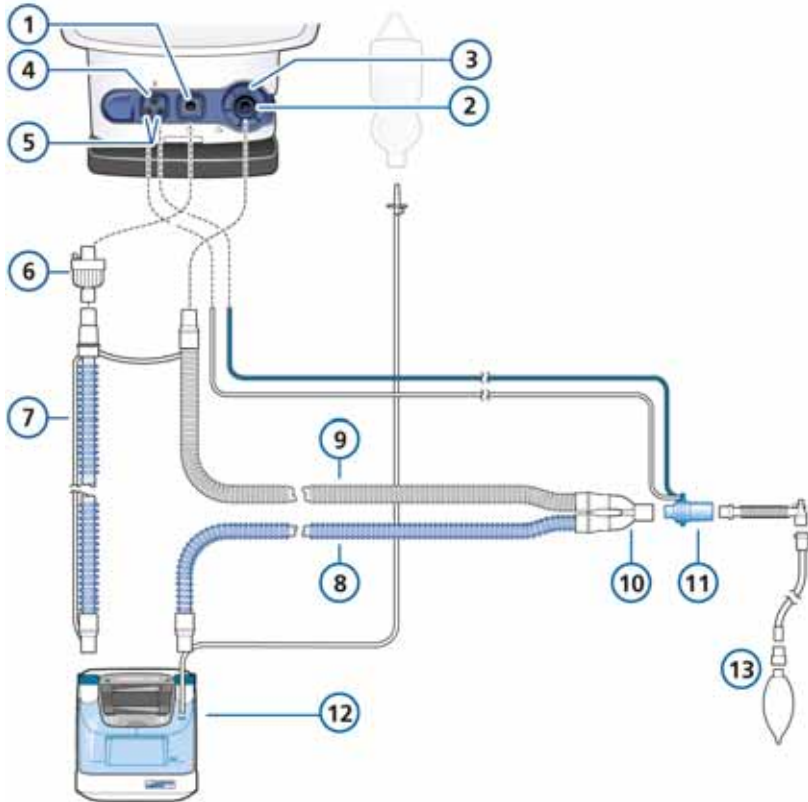

1	To patient	8	Heated inspiratory limb with temperature sensor to patient
2	From patient	9	Expiratory limb
3	Expiratory valve (with membrane cover)	10	Y-piece (integrated with breathing circuit)
4	Nebulizer outlet	11	Flow sensor
5	Flow sensor connectors	12	Humidifier
6	Bacteria filter	13	Patient interface
7	Inspiratory limb to humidifier		

Figure 2-5 Coaxial breathing circuit with HMEF/HME (adult/pediatric)

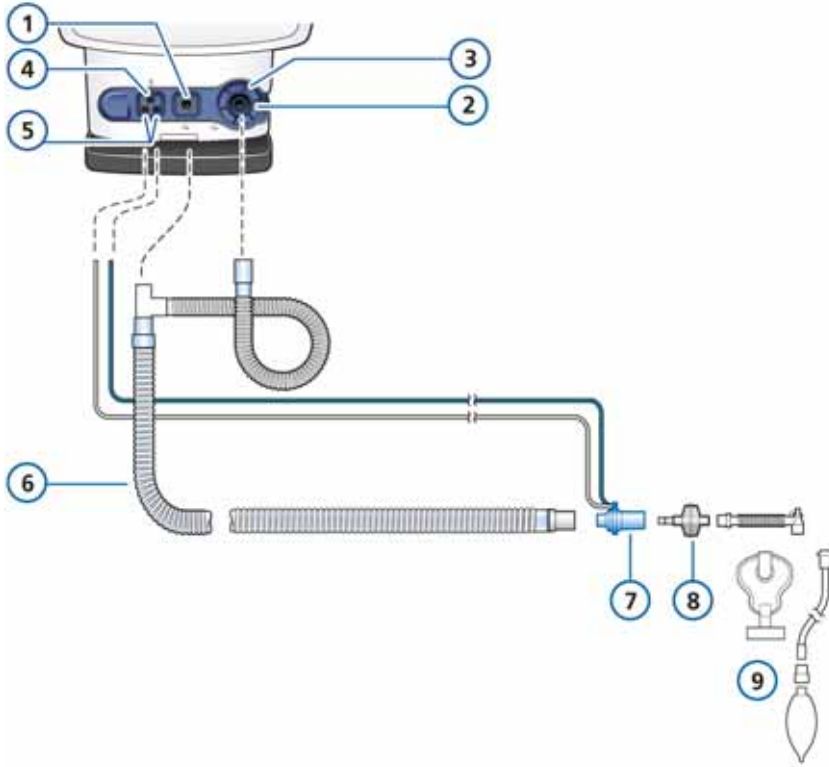

- | | | | |
|---|--|---|--------------------------------------|
| 1 | To patient | 6 | Co-axial inspiratory/expiratory limb |
| 2 | From patient | 7 | Flow sensor |
| 3 | Expiratory valve (with membrane cover) | 8 | HMEF/HME |
| 4 | Nebulizer outlet | 9 | Patient interface |
| 5 | Flow sensor connectors | | |

Figure 2-6 High flow oxygen therapy breathing circuit

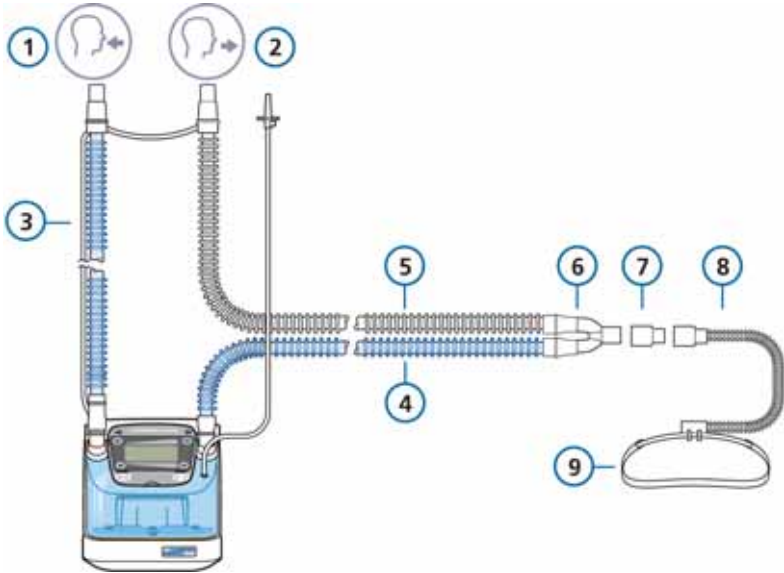

- | | | | |
|---|--|---|---|
| 1 | To patient | 6 | Y-piece (integrated with breathing circuit) |
| 2 | From patient | 7 | Adapter |
| 3 | Inspiratory limb to humidifier | 8 | Nasal cannula |
| 4 | Heated inspiratory limb with temperature sensor to patient | 9 | Attachment strap |
| 5 | Expiratory limb | | |

2.4.3.2 Connecting the flow sensor

NOTICE

To prevent inaccurate flow sensor readings, make sure the flow sensor is correctly installed:

- The flow sensor tubes must not be kinked.
- In the nCPAP-PS mode, the correct position of the flow sensor is at the expiratory valve. For more on neonatal ventilation, see Chapter 5.



To connect a flow sensor to the breathing circuit

1. Insert a flow sensor into the breathing circuit in front of the patient connection.

Figure 2-7 Flow sensor placement with Y-piece

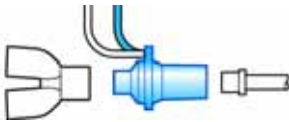

Figure 2-8 Flow sensor placement with coaxial breathing circuit



2. Attach the blue and clear tubes to the flow sensor connectors on the ventilator.

The blue tube connects to the blue connector. The clear tube connects to the silver connector.

3. After positioning the breathing circuit properly (See paragraph 2.4.4), be sure to calibrate the flow sensor.

2.4.4 Positioning the breathing circuit

NOTICE

- To prevent water accumulation in the flow sensor and flow sensor tubing, position the flow sensor tubing on top of the flow sensor.
- Ensure there is no undue stress placed on any tubing or cables.

After assembly, position the breathing circuit so that the hoses will not be pushed, pulled, or kinked as a result of patient movement, transport, or other activities, including scanner bed operation and nebulization.

The next step is to perform all required tests, calibrations, and the preoperational check. See Chapter 3.

2.5 Installing the pneumatic nebulizer

WARNING

- Do not use an expiratory filter or HMEF in the patient's breathing circuit during nebulization. Nebulization can cause an expiratory side filter to clog, substantially increasing flow resistance and impairing ventilation.
- Connect the nebulizer in the inspiratory limb per your institution's policy and procedures. Connecting the nebulizer between the flow sensor and the endotracheal tube increases dead space and causes incorrect volume measurements.
- To prevent the expiratory valve from sticking due to nebulized medications, use only medications approved for

nebulization and regularly check and clean or replace the expiratory valve membrane.

- Be aware that pneumatic nebulization affects delivered oxygen concentration.

NOTICE



Pneumatic nebulization is disabled during neonatal ventilation.

The nebulization feature provides a stable driving pressure to power a pneumatic nebulizer connected to the nebulizer outlet, optimally specified for a flow of approximately 8 l/min.

Connect the nebulizer and accessories as shown in Figure 2-9. See Appendix G for information about compatible nebulizers.

Figure 2-9 Installing a pneumatic nebulizer

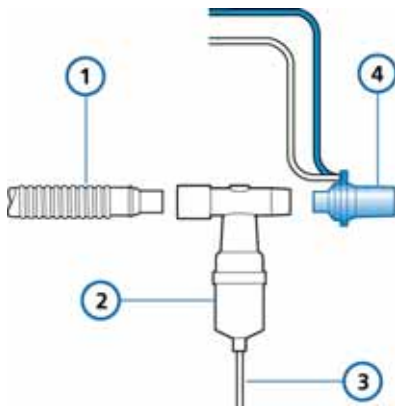

- | | |
|-------------------------------------|------------------|
| 1 Breathing circuit (coaxial shown) | 3 Nebulizer tube |
| 2 Nebulizer | 4 Flow sensor |

2.6 Setting up CO2 monitoring

WARNING

- Always ensure the integrity of the patient breathing circuit after insertion of the airway adapter by verifying a proper CO2 waveform (capnogram) on the ventilator display.
- If the capnogram appears abnormal, inspect the CO2 airway adapter and replace if needed.
- Monitor the capnogram for higher-than-expected CO2 levels during ventilation. These can be caused by sensor or patient problems.
- Use the correct adapter. In adult patients small geometrics may induce low tidal volumes and intrinsic PEEP. In neonatal patients large geometrics increase dead space and impede effective CO2 removal.
- Do not use the CO2 sensor if it appears to have been damaged or if it fails to operate properly. Refer servicing to Hamilton Medical authorized personnel.
- To reduce the risk of explosion, do not place the CO2 sensor in a combustible or explosive environment (for example, around flammable anesthetics or other ignition sources).
- Do not use the CO2 sensor when it is wet or has exterior condensation.

CAUTION

- *Position airway adapters with windows in a vertical, not a horizontal, position. This helps keep patient secretions from pooling on the windows.*
- *All devices are not protected against reanimation with a defibrillator.*
- *Avoid permanent direct contact of the CO₂ sensor with the body. It can burn the skin as the sensor may reach a temperature of 46°C (115°F).*
- *Nebulization may influence the CO₂ measurements.*
- *Disconnect the CO₂ sensor before using a defibrillator on the patient.*

CO₂ monitoring is used for various applications in order to gain information such as the assessment of the patient's airway integrity or the proper endotracheal tube placement.

The HAMILTON-C3 offers two monitoring options:

- Mainstream CO₂ measurement
- Sidestream CO₂ measurement

Whether mainstream or sidestream CO₂ is used to monitor end-tidal CO₂ depends on the clinical setting. A volumetric capnogram as described in Appendix E is only possible with a mainstream CO₂ sensor.

2.6.1 CO₂ mainstream measurement

WARNING

In NIV and neonatal ventilation with uncuffed tubes, leaks may influence the volumetric capnogram and the measured numerical monitoring parameters.

The optional mainstream CO₂ sensor is a solid-state infrared sensor, which is attached to an airway adapter that connects to an endotracheal (ET) tube or other airway and measures bases flowing through these breathing circuit components.

The sensor generates infrared light and beams it through the airway adapter or sample cell to a detector on the opposite side. CO₂ from the patient, flowing through the mainstream airway adapter or aspirated into the sample cell, absorbs some of this infrared energy. The HAMILTON-C3 determines the CO₂ concentration in the breathing gases by measuring the amount of light absorbed by gases flowing through the airway or sample cell.

The HAMILTON-C3 can display measurements derived from the CO₂ sensor as numeric values, waveforms, trends, and loops. The waveform is a valuable clinical tool that can be used to assess patient airway integrity and proper endotracheal (ET) tube placement.

The CO₂ sensor can be easily transferred from one HAMILTON-C3 ventilator to another, even "on the fly", during ventilation.

2.6.1.1 Connecting the CO₂ mainstream sensor

NOTICE

You must use the included adapter to connect the mainstream CO₂ sensor to a neonatal-pediatric flow sensor to avoid increasing dead space.

To set up CO2 monitoring

1. Plug the sensor cable into the CO2 connector on the communication board on the ventilator (Figure 1-5), observing the orientation of the indexing guides on the connector body. The cable should snap into place.
2. Attach the airway adapter to the CO2 sensor:
 - a. Verify that the adapter windows are clean and dry. Clean or replace the adapter if necessary.
 - b. Align the arrow on the bottom of the adapter with the arrow on the bottom of the sensor.
 - c. Press the sensor and the adapter together until they click.

Figure 2-10 Attaching the CO2 sensor to the airway adapter

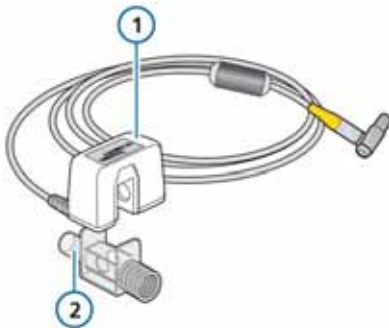

1 CO2 sensor 2 Airway adapter

3. Connect the sensor/airway adapter to the patient circuit as follows (Figure 2-11):
 - d. Place the sensor/airway adapter assembly at the proximal end of the airway circuit as shown.

Do *not* place the airway adapter between the ET tube and the

elbow, as this may allow patient secretions to accumulate in the adapter.¹

- e. Position the airway adapter with its windows in a vertical, not a horizontal, position.

This helps keep patient secretions from pooling on the windows. If pooling does occur, the airway adapter may be removed from the circuit, rinsed with water and reinserted into the circuit. To prevent moisture from draining into the airway adapter, do *not* place the airway adapter in a gravity-dependent position.

Figure 2-11 Connecting the CO2 sensor/airway adapter to the patient circuit

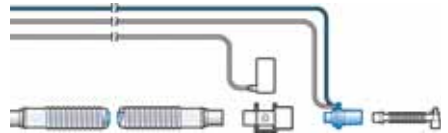

- f. Check that connections have been made correctly by verifying the presence of a proper CO2 waveform (capnogram) on the HAMILTON-C3 display. Monitor the capnogram for higher-than-expected CO2 levels.

If CO2 levels are higher than expected, verify patient condition first. If you determine that the patient's condition is not contributing, calibrate the sensor.

- g. To secure the sensor cable safely out of the way, attach sensor cable holding clips to the airway tubing,

1. You can connect the CO2 sensor before or after the flow sensor according to your institution's protocol.

then connect the sensor cable to the clips. The sensor cable should face away from the patient.

The next step is to calibrate the sensor. See Section 3.3.2.4.

To remove the sensor cable, pull back on the connector sheath and disengage from connector.

2.6.2 CO₂ sidestream measurement

NOTICE

- Neither humidity (noncondensing) nor cyclical pressures (up to 10 kPa) have any effect on the stated accuracy of the device.
- The device performs as stated both when connected to primary power or when running on battery power.

The optional sidestream CO₂ sensor samples gases using a sampling adapter placed into the breathing circuit proximal to the patient. The gas passes through sampling tube to the sample cell (a total of 50ml/min). The sampling tube is water permeable in order to minimize cross interference effects and collision broadening.

The sampling cell measures the gas components using infrared spectroscopy at a wavelength of 4260 nm. The measured values can be displayed by the HAMILTON-C3 as real-time waveform, loops, and trends and as numeric values.

2.6.2.1 Connecting the CO₂ sidestream sensor

⚠ WARNING

- Leakages in the breathing or sampling system may cause the displayed PetCO₂ values to be significantly under-reported (too low).
- Always connect all components securely and check for leaks according to standard clinical procedures. Displacement of the nasal or combined nasal-oral cannulas can cause lower-than-actual PetCO₂ readings.

⚠ CAUTION

- *DO NOT use with patients that cannot tolerate the removal of 50 ml ± 10 ml/min from their total minute volume. In adaptive modes (such as ASV[®], APVcmv, and APVsimv), the removal is fully compensated.*
- *Always use the correct CO₂ adapter. In adult patients, smaller geometrics increase airway resistance and induce low tidal volumes and intrinsic PEEP. In neonatal patients, large geometrics detain effective CO₂ removal.*

To set up CO₂ sidestream monitoring

1. Plug the LoFlow™ sidestream CO₂ module cable into the CO₂ option board connector (yellow), observing the orientation of the indexing guides on the connector body. The cable snaps into place. See Figure 2-12.
2. Plug the sample cell into the CO₂ module as shown in Figure 2-12. The connector "clicks" into place.

3. Inserting the sample cell into the receptacle automatically starts the sampling pump. Removal of the sample cell turns the sample pump off.
 4. Before attaching the airway adapter, the CO2 sensor needs to be calibrated. See Section 3.3.2.4.
 5. Attach the airway adapter between the flow sensor and ET tube.
- The sampling line should face away from the patient.
6. To secure the sampling line safely out of the way, attach the sensor cable holding clips to the airway tubing, then connect the sampling line to the clips.

Figure 2-12 Inserting the sample cell into the CO2 module

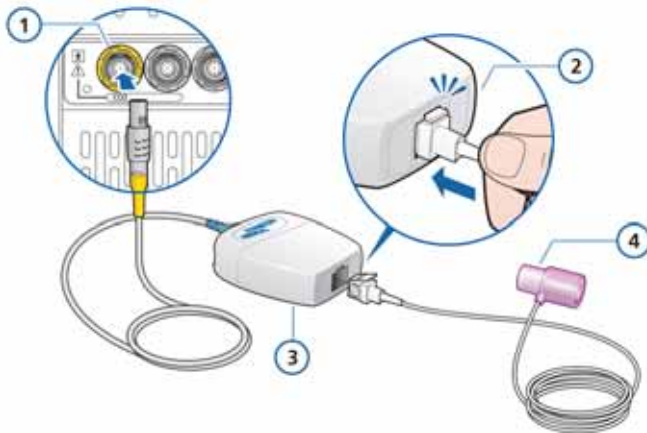

- | | | | |
|---|-------------------------------|---|------------------------------|
| 1 | CO2 connection on ventilator | 3 | LoFlow sidestream CO2 module |
| 2 | Sample cell clicks into place | 4 | Airway adapter |

Figure 2-13 Attaching the CO2 sensor (1) to the airway



To remove the sampling kit sample cell from the receptacle, press down on the locking tab and pull the sample cell out of the receptacle.

2.7 Setting up the SpO2 sensor

See the Hamilton Medical *Pulse Oximetry Instructions for Use*.

2.8 Installing the Aerogen Pro nebulizer

NOTICE

Connect only approved piezo nebulizers to the HAMILTON-C3 ventilator.

The Aerogen Pro nebulizer system is available as an option for the HAMILTON-C3. Attach it to the mounting bracket. Consult the operating instructions supplied with the nebulizer for further installation and operating information.

2.9 Connecting to a power source

NOTICE

- To prevent unintentional disconnection of the power cord, make sure it is well seated into the ventilator socket and secured with the power cord retaining clip.
- Install the ventilator in a location where the primary power can be easily disconnected.
- The HAMILTON-C3 does not require protective earth grounding, because it is a class II device, as classified according to IEC 60601-1.

Either AC or DC can supply the primary power to the HAMILTON-C3.

2.9.1 Connecting to AC power

Connect the HAMILTON-C3 to an outlet that supplies AC power between 100 and 240 V AC, 50/60 Hz.

Always check the reliability of the AC outlet. When connected to AC power, the AC

symbol in the bottom right-hand corner of the screen shows a frame around it.

2.9.2 Connecting to DC power

WARNING

- Connect the HAMILTON-C3 to the 12 to 24 V DC onboard power circuit of an ambulance vehicle only.
- Use only cables supplied by Hamilton Medical.

NOTICE

- Only the Hamilton Medical car adapter is allowed to be used with the HAMILTON-C3.
- The input power of the car adapter, 12/24 V (11 to 32 V), ensures that both ventilator batteries are charged.
- The car adapter is intended for use during secondary transport.
- The use of the car adapter in aircraft is not permitted.

The ventilator can be connected to the DC power source, with the Hamilton Medical car adapter (required). The car adapter transfers input voltage to 24 V, thereby charging the batteries.

For ordering information, see Appendix G.

2.10 About the batteries

WARNING

- The batteries will not charge if the ambient temperature is above 43°C.
- Be aware that ventilation stops if the internal batteries are fully discharged and no external supply is available.

- Periodically check or replace the battery.

NOTICE

- The use of one battery is mandatory. The battery is used as internal backup battery. A second optional battery can also be used.
- Hamilton Medical recommends that the ventilator's batteries be fully charged before you ventilate a patient. If the batteries are not fully charged and AC power fails, always pay close attention to the level of battery charge.
- The device generates alarms to alert you to low battery capacity. For details, see the Battery low alarm description on page page 159.
- The battery depletion rate may vary according to the age of the battery, ventilation mode, temperature, settings, etc.

power source. When the primary power source fails, the ventilator automatically switches to operation on backup battery with no interruption in ventilation. An alarm sounds to signal the switchover.

Silence the alarm to confirm notification of the power system change; this resets the alarm.

If the optional battery (battery 2, on the right) is available and adequately charged, the ventilator switches to this battery first. When it is depleted or not installed, the ventilator switches to the standard battery (battery 1).

The batteries power the ventilator until the primary power source is again adequate or until the battery is depleted.

It also has a capacitor-driven backup buzzer that sounds continuously for at least 2 min when battery power is completely lost.

The ventilator charges the battery whenever the ventilator is connected to the primary power supply (AC or DC > 20 V), with or without the ventilator being turned on. The battery charge indicator lights show that the battery is being charged.

A backup battery protects the ventilator from low power or failure of the primary

Figure 2-14 Power source symbols and battery charge indicator

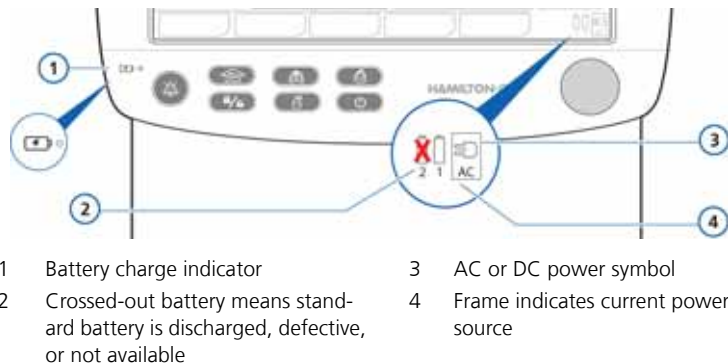

The power source symbols in the bottom right-hand corner of the screen show the available power sources. A frame around a symbol indicates the current ventilator power source. Green indicates the level of battery charge.

Each battery has its own icon, 1 and 2.

Check the battery charge level before putting the ventilator on a patient and before unplugging the ventilator for transport or other purposes.

The charge level is indicated as follows:

- A green symbol indicates a fully charged battery.
- An orange and green symbol indicates a partially charged battery.
- If the battery symbol is crossed out, the battery is discharged, defective, or not available
- If battery symbol 2 is not shown, the optional battery is not installed.

If a battery is not fully charged, recharge it by connecting the ventilator to the primary power source for a minimum of 4 hours, until the battery charge level is 80% to 100%. Alternatively, the battery can also be charged with the external charger.

Chapter 11 describes how to charge and replace the battery.

2.11 Connecting the oxygen supply

WARNING

- It is *NOT* permitted to use the equipment with flammable gases or anaesthetic agents. Danger of fire!
- It is *NOT* permitted to use the ventilator with helium or mixtures of helium.
- An O2 cell must be installed.

CAUTION

- *Always check the status of the oxygen cylinders or other supply before using the ventilator during transport.*
- *Make sure oxygen cylinders are equipped with pressure-reducing valves.*
- *To minimize the risk of fire, do not use high-pressure gas hoses that are worn or contaminated with combustible materials like grease or oil.*

NOTICE

- To prevent damage to the ventilator, connect only clean, dry medical-grade oxygen.
- Before starting ventilation, make sure the appropriate oxygen source, either high-pressure oxygen (HPO mode) or low-pressure oxygen (LPO mode), was selected when configuring the ventilator.

Set the source type in the Tools window (in Standby mode). See Section 2.11.3.

Oxygen for the HAMILTON-C3 can come from a high- or low-pressure source.

- High-pressure oxygen, provided by a central gas supply or a gas cylinder, is supplied through DISS or NIST male gas fittings. With the optional cylinder holder, you can mount oxygen cylinders to the trolley. If you use gases from cylinders, secure the cylinders to the trolley with the accompanying straps.

Pressure	2.8 – 6 bar / 280 to 600 kPa / 41 – 87 psi
----------	--

- Low-pressure oxygen is provided by a concentrator or liquid cylinder.

Flow	≤ 15 l/min
Pressure	≤ 6 bar / 600 kPa / 87 psi

For important safety information related to the use of low-pressure oxygen, see Section 2.11.1.

The selected setting is active until manually changed or the ventilator is restarted.

2.11.1 Using a low-pressure oxygen supply

CAUTION

- *To reduce the risk of fire:*
 - *DO NOT use a low-pressure oxygen source that delivers a flow greater than 15 l/min.*
 - *Ensure adequate ventilation at the rear of the ventilator.*
 - *Switch off the oxygen source when the ventilator is not in a ventilating mode.*
- *To prevent possible patient injury when the ventilator is sourced from an oxygen concentrator, never operate the concentrator with a humidifier. Any humidifier system supplied with the concentrator must be drained or removed before using the ventilator.*
- *The ventilator's Oxygen control is not active when low-pressure oxygen is used. It is the operator's responsibility to control the oxygen setting.*

- *To prevent possible patient injury, use low-pressure oxygen only in cases where the low-pressure source can provide an adequate level of oxygenation.*
- *To prevent possible patient injury, ensure that an emergency backup oxygen supply (for example, a cylinder) is available in case the low-pressure oxygen source fails.*
- *To calibrate the O2 cell, disconnect all O2 supplies. Calibration is done at 21%.*
- *To protect the oxygen control system, do not supply both high- and low-pressure oxygen to the ventilator simultaneously.*

Using the low-pressure oxygen supply involves two steps:

- Connecting the supply to the ventilator (Section 2.11.2)
- Selecting the source type on the ventilator (Section 2.11.3)

2.11.2 Connecting the oxygen supply to the ventilator

NOTICE

Only use low-pressure hoses that comply with ISO 5359 to connect the device to the oxygen supply.

To connect the oxygen supply to the ventilator

- ▶ Connect the oxygen hose to the HAMILTON-C3's high-pressure or low-pressure oxygen inlet fitting (Figure 2-15).

See Section 2.11.3 for details on selecting the oxygen source on the device.

Figure 2-15 Oxygen inlet fittings

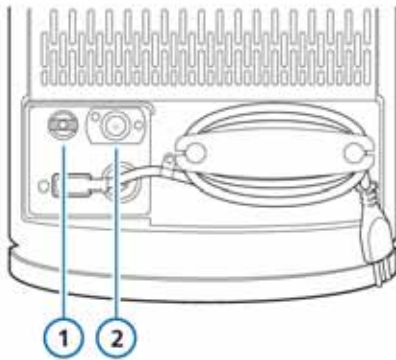

- 1 Oxygen low-pressure inlet fitting (for safety information, see Section 2.11.1)
- 2 Oxygen high-pressure inlet fitting

2.11.3 Selecting the oxygen source type

Before starting ventilation, be sure to select the appropriate oxygen source. By default, the ventilator is set to high-pressure oxygen (HPO).

You set the source in Standby mode.

To select the oxygen source

1. In Standby mode, touch the **Tools** button.
By default, the Gas source window is displayed.

Figure 2-16 Gas source window

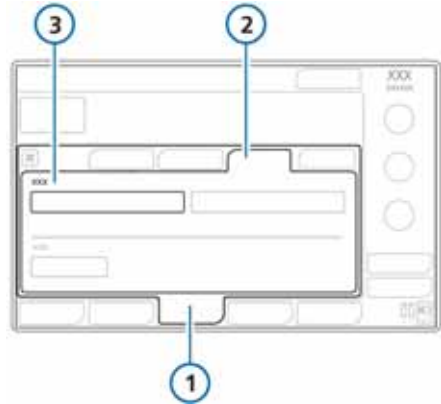

- 1 Tools
 - 2 Utilities
 - 3 Gas source: HPO, LPO
2. Touch the appropriate button for the desired oxygen source.
 - Select **HPO** for high-pressure oxygen (the default)
 - Select **LPO** for low-pressure oxygen (see Section 2.11.1)The ventilator always resets to HPO mode when restarted.
 3. Close the window.

2.12 Working with the trolley

⚠ WARNING

- To prevent possible personal injury and equipment damage, make sure the ventilator is properly secured to the trolley.
- To prevent possible tipping of the trolley and equipment damage:
 - Lock the trolley's wheels when parking the ventilator.
 - Take care when crossing thresholds.
 - The table below describes the warning labels provided with the HAMILTON-C3 trolley.

Table 2-1 HAMILTON-C3 trolley warning labels



Make sure the wheel brakes are unlocked when moving the trolley.



Do not lean on the trolley.



Do not park the trolley on an incline greater than 5 degrees.



Weight
The maximum safe working load applies to a stationary properly load-balanced trolley.

2.12.1 Installing the patient tubing support arm

⚠ WARNING

To prevent possible patient injury due to accidental extubation, check the support arm joints and secure as necessary.

Install the patient tubing support arm on either side of the HAMILTON-C3 trolley.

Figure 2-17 Patient tubing support arm (1)

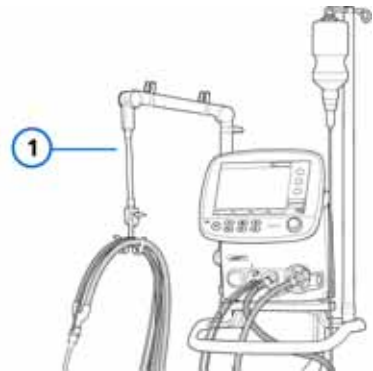

2.12.2 Preparing the trolley for intrahospital transport

⚠ WARNING

- Only the components listed in this section are approved for intrahospital transport.
- Use of additional items, such as a patient support arm, can result in the trolley tipping over.
- The ventilator must be attached to the trolley. Ensure the device is securely attached before use.

NOTICE

The following requirements apply only to transport using ventilators mounted on a HAMILTON-C3 trolley. They do not apply to other mounting solutions.

If using a HAMILTON-C3 trolley, the ventilator and its components, as well as the trolley, **must be** configured and positioned as follows during transport within the hospital:

- The ventilator must be securely mounted on the trolley
- The O2 cylinder must be securely attached to the trolley
- *Only* the following components are allowed to be connected during transport:
 - Breathing circuit
 - Flow sensor
 - CO2 sensor (mainstream or side-stream)
 - O2 cylinder
 - Humidifier
 - SpO2 sensor, including Masimo adapter board

2.13 Connecting to an external device

WARNING

All devices connected to the HAMILTON-C3 must be for medical use and meet the requirements of standard IEC 60950-1.

You can connect your ventilator to a patient monitor, a Patient Data Monitoring System (PDMS), or a computer using the optional communication board. See Appendix H.

2.14 Turning on the ventilator

CAUTION

- *To ensure the ventilator's safe operation, always run the preoperational check before using the ventilator on a patient.*
 - *If the ventilator fails any tests, remove it from clinical use immediately. Do not use the ventilator until necessary repairs are completed and all tests have passed.*
-

NOTICE

If the HAMILTON-C3 is new, be sure it has been properly configured for default language, alarms, and other important settings (see Appendix I).

To turn on the ventilator

1. Press the ventilator Power/Standby key. The ventilator runs a self-test.

Figure 2-18 Power/Standby key (1)



After a short time, the patient setup window is displayed.

2. Set up the ventilator as described in Chapter 4.
3. Run the preoperational check (Section 3.2).

2.15 Turning off the ventilator

NOTICE

The ventilator remains connected to power when the power is turned off. This permits the battery to charge. To completely disconnect the ventilator from power, unplug it from the primary power outlet.

To turn off the HAMILTON-C3

1. From active ventilation, press the Power/Standby key to access Standby, and touch the **Activate standby** on-screen button to confirm. Press and hold the Power/Standby > 3 seconds to power off the ventilator.
2. If there is a technical fault, press and hold the Power/standby key for > 10 seconds.

2.16 Display navigation guidelines

Use the touch screen and the press-and-turn (P&T) knob to access the HAMILTON-C3 ventilation parameters and monitored data. You typically use a select - activate or select - activate - adjust - activate procedure.

To open a window

- ▶ Touch the window tab to select and activate it, or turn the P&T knob to select the window tab (it is framed in yellow) and then press the knob to activate your selection.

**To close a window**

- ▶ Touch the window tab or the X in the upper left-hand corner to select and activate it, or turn the P&T knob to select the X (it is framed in yellow) and then press the knob to activate your selection.

**To adjust a control**

1. Touch the control to select and activate it; or turn the P&T knob to select the control (it is framed in yellow) and then press the knob to activate your selection.



The activated control turns orange.

2. Turn the knob to increase or decrease the value.
3. Press the knob or touch the control to confirm the adjustment and deactivate.

To scroll through a list using the scroll bar or arrows



1. Touch the scroll bar to select and activate it; or turn the P&T knob to select the scroll bar (it is framed in yellow) and then press it to activate your selection.
Your selection turns orange when activated.
2. Turn the P&T knob to scroll through the list.
3. Touch the scroll bar or press the knob to deactivate.

3

Tests, calibrations, and tools

3.1	Overview	64
3.2	Running the preoperational check	64
3.3	System functions	66
3.4	Tools	73
3.5	Alarm tests	74

3.1 Overview

NOTICE

The device provides automatic barometric pressure compensation.

The tests and calibrations described in this section help verify the safety and reliability of the HAMILTON-C3. Perform the HAMILTON-C3's tests and calibrations as described in Table 3-1. If a test fails, troubleshoot the ventilator as indicated or have the ventilator serviced. Make sure the tests pass before you return the ventilator to clinical use.

Table 3-1 When to perform tests and calibrations

Test or calibration	When to perform
Preoperational check	Before connecting a new patient to the ventilator
<p>CAUTION</p> <p><i>To ensure the ventilator's safe operation, always run the full preoperational check before using the ventilator on a patient. If the ventilator fails any tests, remove it from clinical use immediately. Do not use the ventilator until necessary repairs are completed and all tests have passed.</i></p>	
Tightness test, flow sensor calibration	After installing a new or decontaminated breathing circuit or component (including a flow sensor or pressure-monitoring line)
Oxygen cell calibration	After installing a new oxygen cell or when a related alarm occurs

Table 3-1 When to perform tests and calibrations

Test or calibration	When to perform
CO2 sensor/adapter calibration (mainstream/sidestream)	Required after installing a new, previously unused CO2 sensor or when a related alarm occurs; recommended after switching between different airway adapter types
<p>NOTICE</p> <p>All calibration data is saved in the sensor head. Therefore, when a previously used sensor is reconnected, you need not recalibrate the sensor unless you have changed the adapter type.</p>	
Alarm tests	As desired

3.2 Running the preoperational check

CAUTION

- To prevent possible patient injury, disconnect the patient from the ventilator before running this test.
- Make sure another source of ventilatory support is available.

When to perform: Before connecting a new patient to the ventilator.

Required materials: Use the setup below appropriate to your patient group. To ensure that the ventilator also functions according to specifications on your patient, we recommend that your test circuit be equivalent to the circuit used for ventilation.



For details on running the preoperational check for neonatal ventilation, see Chapter 5.

Table 3-2 Breathing circuit setup

Adult/ pediatric patients	<ul style="list-style-type: none"> Breathing circuit, 15-22 mm ID with 2F connectors Flow sensor, pediatric/adult Demonstration lung, 2 l, with adult ET tube between flow sensor and lung (PN 151815 or equivalent)
---------------------------------	---

Procedure:

Table 3-3 When to perform tests and calibrations

Do or observe...	Verify/Notes
1. Connect ventilator to primary power and an oxygen supply.	
2. Assemble the patient breathing circuit.	Breathing circuit is assembled correctly. See Section 2.4.3.
3. Turn on power.	During the self test, the red and yellow alarm lamp flashes in sequence and the buzzer sounds briefly. When complete, the alarm lamp flashes red again.
4. Make sure the ventilator is in standby, and select Preop check on the Standby/Setup window.	The System > Tests & calib window opens.

Table 3-3 When to perform tests and calibrations

Do or observe...	Verify/Notes
5. Select and run the tightness test, then the flow sensor calibration. Follow all prompts.	These tests and calibrations pass. See Section 3.3.2.
6. If necessary, run O2 cell calibration. Close window.	This calibration passes. See Section 3.3.2.3.
7. Generate an alarm (for example, by disconnecting primary power).	Corresponding alarm message is displayed in message bar (for example, Loss of external power). Note that, in standby, patient alarms are suppressed.
8. Resolve the alarm situation (for example, reconnect mains power).	Alarm is reset.

Corrective action: If the ventilator does not pass the preoperational check, have it serviced.

3.3 System functions

You can run tests and calibrations, view device-specific information, and perform other ventilator system functions from the System window.

3.3.1 Info: Viewing device-specific information

Open the System -> Info window to view device-specific information including serial number, model, operating hours, hours since startup, time to service, battery capacity, oxygen consumption, software version, and installed options.

Figure 3-1 Info window

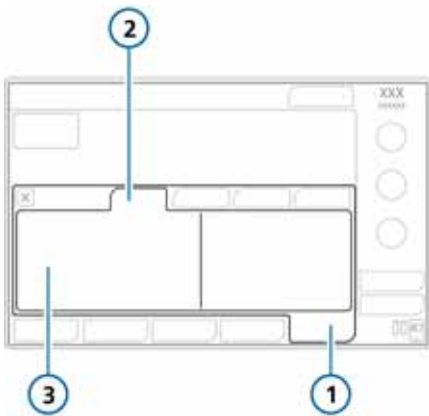

- 1 System
- 2 Info
- 3 System details

3.3.2 Tests & calib: Running the tightness test and calibrations

NOTICE

- To enable or disable O2 and CO2 monitoring, see Section 3.3.3.
- The audible alarm is silenced during the calibration functions and for 30 s thereafter.

The following tests and calibrations are provided, depending on your device and selected ventilation mode:

Table 3-4 Tests and calibrations

	See
Tightness test	Section 3.3.2.1
Flow sensor calibration	Section 3.3.2.2 and Chapter 5 (neonatal)
O2 cell calibration, if needed	Section 3.3.2.3
CO2 sensor calibration, when enabled	Section 3.3.2.4

To access tests and calibration functions

- Touch the **System** button, then touch the **Tests & calib** tab.

Figure 3-2 Tests & calib window

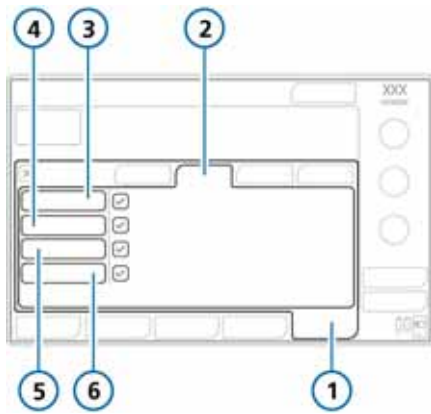

- | | |
|-----------------|---------------|
| 1 System | 4 Flow sensor |
| 2 Tests & calib | 5 O2 cell |
| 3 Tightness | 6 CO2 sensor |

3.3.2.1 Performing the tightness test

NOTICE

- Make sure another source of ventilatory support is available during this test. The patient must be disconnected from the ventilator during the test.
- Circuit resistance compensation is measured during calibration.
- Perform this test after installing a new or decontaminated breathing circuit or component (including a flow sensor).
- To cancel the tightness test while it is in progress, touch the **Tightness** button again.
- When using HiFlowO2 therapy, the tightness test only verifies the correct functioning of the pressure release valve on the ventilator.

- In this mode, the expiratory limb and flow sensor do not need to be connected to the device during the tightness test as it does not measure the tightness of the breathing circuit when using HiFlowO2 therapy.

Description: This test checks for leakage in the patient breathing circuit. The ventilator is pressurized to 45 cmH2O. The circuit is considered tight if this pressure can be maintained.

Procedure:

1. Set the ventilator up as for normal ventilation, complete with the breathing circuit.
2. In the System > Tests & calib window, touch **Tightness**.
The text **Disconnect patient** is now displayed.
3. Disconnect the breathing circuit at the patient side of the flow sensor. Do not block the open end of the flow sensor.
The text **Tighten patient system** is now displayed.
4. Block the opening (wearing a sterilized glove is recommended).



The text **Connect patient** is now displayed.

5. Connect the patient.
6. When the test is complete, verify that there is a green checkmark in the **Tightness** checkbox.

In case of test failure

If the test fails, a red X is displayed in the **Tightness** checkbox.

Perform the following checks, repeating the tightness test after each one, until the test is successful:

- Check the breathing circuit for a disconnection between the ventilator and the flow sensor, or for other large leaks (for example, breathing circuit, humidifier).
- Check that the expiratory valve is correctly installed.
- Replace the breathing circuit, flow sensor, and expiratory valve.

If the problem still persists, have the ventilator serviced.

3.3.2.2 Flow sensor calibration

NOTICE

- Make sure another source of ventilatory support is available during this calibration. The patient must be disconnected from the ventilator during the test.
- To cancel the flow sensor calibration while it is in progress, touch **Flow Sensor** again.
- Circuit resistance compensation is measured during calibration.
- If there is a mismatch between the active patient profile and the flow sensor type you are using, the calibration fails. Ensure you are using the correct flow sensor for the patient.
- For details about neonatal ventilation, tests, and calibration, see Chapter 5.

Description: This calibration checks and resets the calibration points specific to the flow sensor in use.

Choose the appropriate process for the patient group:

- Adult/pediatric
- Neonate/infant. For details, see Chapter 5.

To calibrate an adult/pediatric flow sensor

1. Set the ventilator up as for normal ventilation, complete with breathing circuit and flow sensor.
2. In the System > Tests & calib window, touch **Flow sensor**.

If you have not already disconnected the patient, the message line displays **Disconnect patient**.

3. Disconnect the patient now.

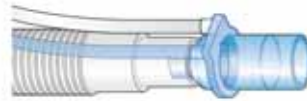

4. Follow the instructions displayed in the message line, attaching the adapter when needed and turning the flow sensor around as indicated.

If using the disposable flow sensor PN 281637, the additional adapter for calibration must be attached.

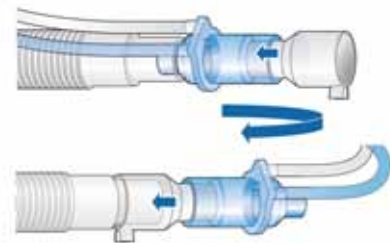

5. Follow the instructions displayed in the message line, turning the flow sensor back to its starting position when indicated.
6. When calibration is complete, verify that there is a green check mark in the **Flow Sensor** checkbox.
7. When successful, touch the **Start ventilation** button in the Standby window, and connect the patient, as indicated.

In case of calibration failure

If the calibration fails, a red X is displayed in the **Flow Sensor** checkbox.

Perform the following checks, repeating the calibration after each one, until calibration is successful:

- Check the breathing circuit for a disconnection between the ventilator and the flow sensor, or for other large leaks (for example, breathing circuit, humidifier).
- Check that the correct flow sensor is connected, and that the flow sensor and expiratory valve/membrane are properly seated.
- If the calibration fails again, replace the flow sensor.
- If the calibration still fails, replace the expiratory valve/membrane.

If the problem persists, have the ventilator serviced.

3.3.2.3 Oxygen cell calibration

NOTICE

- The oxygen cell calibration requires that the ventilator's oxygen monitoring be enabled. To check for an oxygen cell, see Section 11.3.3. To determine whether oxygen monitoring is enabled, check the System -> Sensors on/off window and ensure the **O2 cell** checkbox is selected.
- If using the low-pressure-mode, disconnect all O2 supplies during calibration. After reconnecting, the oxygen concentration is set to 21%.
- The O2 cell requires approximately 30 minutes warm-up time to reach stable values. O2 monitoring during this time period may be more variable. We recommend performing the calibration after the O2 cell is warmed up.
-  When the Neonatal patient group is selected, the ventilator must be in Standby to perform O2 cell calibration.

Description: During the 2-min calibration of the oxygen cell, the ventilator sets the oxygen concentration as shown in Table 3-5. The device tests the cell and resets the calibration points specific to the cell in use.

Table 3-5 Oxygen concentrations during O2 cell calibration

Standby or active ventilation	Gas source/connection status	Oxygen (FIO2) setting	Oxygen concentration used during calibration
Recommended settings for calibration at 100% oxygen			
Standby	HPO/connected	> 21%	100%
Active ventilation	HPO/connected	> 21%	100%
Settings for calibration at 21% oxygen			
Standby	HPO/disconnected	any	21%
Standby	HPO/connected	21%	21%
Standby	LPO/disconnected	any	21%
Active ventilation	HPO/connected	21%	21%
Active ventilation	LPO/disconnected	any	21%

We recommend calibrating the O2 cell using 100% oxygen to improve the stability of measurements at higher oxygen concentrations during use. To this end, use the information in Table 3-5 to choose the associated settings and connections for calibration.

Procedure:

1. *Recommended.* To calibrate at 100% oxygen, adjust the settings on the ventilator as needed (Table 3-5).
2. In the Tests & calib window, touch **O2 cell**.
3. When calibration is complete, verify that there is a green check mark in the O2 cell checkbox.

In case of calibration failure

If the calibration fails, a red X is displayed in the O2 cell checkbox.

Perform the following checks, repeating the calibration after each one, until calibration is successful:

- Ensure O2 cell is connected and a Hamilton Medical O2 cell is used (PN 396200).
- If the second calibration attempt fails, replace the O2 cell.

If the problem persists, have the ventilator serviced.

3.3.2.4 CO2 sensor/adaptor zero calibration

CAUTION

- *Always calibrate the CO2 sensor with the sensor attached to the airway adapter.*
- *Be sure NOT to cover both ends of the airway adapter with your fingers.*

NOTICE

- Wait at least 20 s – and for best results, 2 min – to perform the CO2 sensor/adapter calibration after removing the adapter from the patient's airway. This time allows any CO2 remaining in the adapter to dissipate.
- If you close the Tests & calib window when the calibration has failed, the HAMILTON-C3 starts or continues ventilating, but continues to display **CO2 sensor calibration needed**. This may result in inaccurate monitoring.

Description: The CO2 sensor/adapter zero calibration compensates for the optical differences between airway adapters and for sensor drift.

Procedure:

1. Before you begin, ensure:
 - The CO2 hardware option is installed and activated. Once enabled, the sensor requires approximately 90 seconds to warm up.
 - CO2 monitoring is enabled (System -> Sensors on/off)
2. Disconnect the CO2 sensor from the breathing circuit.
3. Attach the CO2 adapter to the sensor. See Figure 2-10 (mainstream) and Figure 2-12 (sidestream).

Place the sensor/adapter away from all sources of CO2 (including the patient's and your own exhaled breath) and the exhaust port of the expiratory valve.

4. Connect the sensor cable to the CO2 connection on the ventilator.

5. In the System -> Tests & calib window, touch **CO2**.

Sensor calibration takes place.

Do not move the sensor during calibration.

6. Verify that there is a green check mark in the CO2 checkbox.

In case of calibration failure

If the calibration fails, a red X is displayed in the CO2 checkbox.

Perform the following checks, repeating the calibration after each one, until calibration is successful:

- Check airway adapter and clean if necessary.
- Ensure there is no source of CO2 near the airway adapter.
- Connect a new airway adapter.
- Install a new CO2 sensor.

If the problem persists, have the ventilator serviced.

3.3.3 Enabling/disabling O2, CO2, and/or SpO2 monitoring**CAUTION**

The HAMILTON-C3's oxygen monitoring function can be disabled. Ensure that an alternative means of oxygen monitoring is always available and enabled.

NOTICE

To enable the optional CO2 and/or SpO2 monitoring, you must first enable the associated hardware option in configuration.

To enable sensor monitoring

1. Open the System > Sensors > On/off window.
2. Select the appropriate checkboxes (O2, CO2, SpO2) to enable/disable the monitoring functions, as desired.

The ventilator always enables O2 monitoring upon restart.

Figure 3-3 Sensors > On/Off window

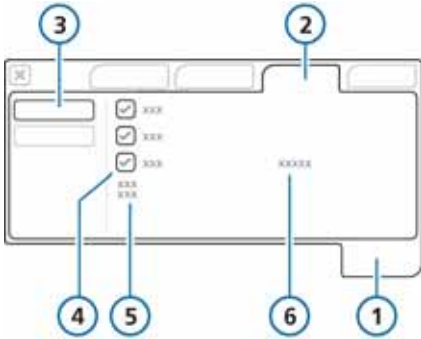

- | | |
|-----------|---------------------------------------|
| 1 System | 4 Sensor options (O2 cell, CO2, SpO2) |
| 2 Sensors | 5 SpO2 sensor status ¹ |
| 3 On/Off | 6 SpO2 sensor type ¹ |

¹ If the SpO2 option is installed and activated.

3.3.4 Setting day and night display brightness

Use these settings to set the brightness of the display for use during the day and night.

Figure 3-4 Day & Night window

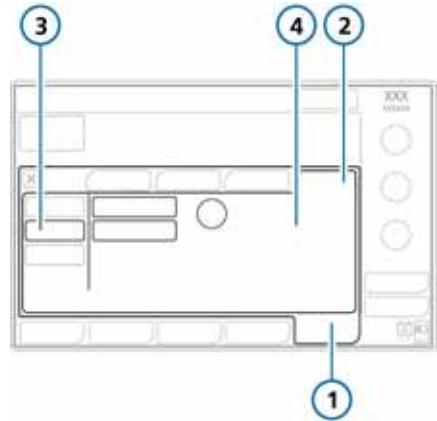

- | | |
|------------|-----------------------------------|
| 1 System | 3 Day & Night button |
| 2 Settings | 4 Day, Night, Brightness settings |

To set the display brightness

1. Open the System -> Settings window.
2. To select Day mode with a bright display, touch the **Day** button.
To select Night mode with a dimmer display, touch the **Night** button.
3. Adjust the brightness of the display in each mode using the **Brightness** control. The setting you choose becomes the new default for that mode.

Setting	Brightness range	Default
Day	10% to 100%	80%
Night	10% to 100%	40%

3.3.5 Setting date and time

NOTICE

Make sure the date and time are set correctly so that event log entries have accurate time and date stamps.

Figure 3-5 Date & Time settings

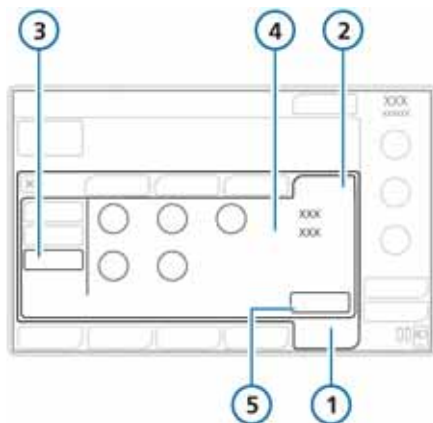

- | | |
|---------------|--------------------------|
| 1 System | 4 Date and time settings |
| 2 Settings | 5 Apply button |
| 3 Date & Time | |

To set the date and time

1. Open the System -> Settings window.
2. Touch **Date & Time** and adjust the day and time.
3. Touch the **Apply** button to save the changes.

3.4 Tools

The Tools window provides access to the following functions:

- P/V Tool, if installed. See Chapter 10.
- Inspiratory and expiratory hold. See Section 9.7.
- Selecting the gas source (HPO or LPO). See Section 2.11.3.
- Accessing the Configuration window. See Appendix I.
- Transferring event log data to a USB memory device

3.4.1 Copying event log data to a USB memory device

NOTICE

- Touch the HAMILTON-C3 before using the USB port.
- The USB connector is intended for passive memory devices only.
- Do not remove the memory device before the files are successfully transferred.
- The memory device must be USB 1.1 compatible.
- A jpg file can be stored to the memory device using the Print screen key.

You can save the event and service logs to a USB memory device. The device must have a FAT or FAT32 format and it must not have an operating system or a security system installed.

To save the logs

1. Place the ventilator into standby and insert a memory device into the USB connector.
2. Open the Tools -> Utilities window (Figure 3-6), and select **Export logs**.
3. Remove the memory device when **File transfer successful** is displayed.

A folder named *C3_sn<Serial Number>* is created on the memory device containing all event log and service log files.

Figure 3-6 Data transfer window

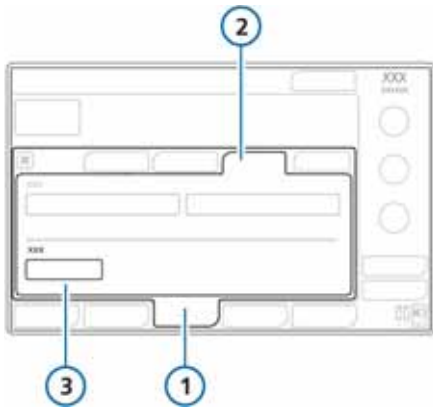

- | | |
|-------------|------------------------------|
| 1 Tools | 3 Data transfer: Export logs |
| 2 Utilities | |

3.5 Alarm tests

The HAMILTON-C3 performs a self-check during start-up and continuously during operation. This self-check verifies the alarm functionality. You may also want to run alarm tests, which demonstrate the alarms' operation.

Before performing the alarm tests, set the HAMILTON-C3 up as for normal ventilation, complete with breathing circuit and 2 l demonstration lung assembly with ET tube.

3.5.1 High pressure

1. Make sure a demonstration lung assembly is connected to the ventilator.
2. Put the ventilator into the PCV+ mode.
3. Set the Pressure alarm limit to 15 cmH₂O above the measured Ppeak.
4. Squeeze the demonstration lung hard during inspiration.
5. Verify that the High pressure alarm is activated, the ventilator cycles into exhalation, and pressure falls to the PEEP/CPAP level.

3.5.2 Low minute volume

1. Put the ventilator into a ventilation mode, for example, PCV+, and start ventilation.
2. Let the ventilator deliver 10 breaths with no alarms.
3. Adjust the minimum ExpMinVol alarm limit so it is higher than the measured value.
4. Verify that the Low minute volume alarm is activated.

3.5.3 Low oxygen alarm

1. Put the ventilator into a ventilation mode, for example, PCV+, and start ventilation.
2. Set the **Oxygen** control to 50%.
3. Wait for 2 min.
4. Disconnect the oxygen supply.
5. Verify the following:
 - The Oxygen concentration displayed in the monitoring window decreases.
 - The **Low oxygen** alarm activates.
6. Wait 30 s or until the oxygen concentration falls below 40%.
7. Reconnect the oxygen supply.
8. Verify that the **Low oxygen** alarm resets. The alarm should reset when the measured oxygen exceeds 45%.

3.5.4 Disconnection on patient side

1. Disconnect the demonstration lung during active ventilation.
2. Verify that the **Disconnection on patient side** alarm is activated.
3. Reconnect the demonstration lung.
4. Verify that the alarm resets and that the ventilator automatically resumes ventilation.

3.5.5 Loss of external power

1. With the ventilator connected to AC power, turn it on.
2. Disconnect the power cord.
3. Verify that the **Loss of external power** alarm is activated and that the ventilator is powered by its backup battery.
4. Reconnect the ventilator to AC power.
5. Verify that the alarm resets and that the ventilator is again powered by AC.

3.5.6 Exhalation obstructed

1. Block the expiratory valve exhaust port during active ventilation.
2. Observe the pressure rise.
3. Verify that the **Exhalation obstructed** alarm is activated.

3.5.7 Apnea

1. Put the ventilator into SPONT mode. Make sure apnea backup ventilation is disabled.
2. Wait for the set apnea time.
3. Verify that the **Apnea** alarm is activated.
4. Squeeze the demonstration lung.
5. Verify that the **Apnea** alarm resets.

4

Ventilator settings

4.1	Overview	78
4.2	Patient grouping	78
4.3	Quick setup settings	78
4.4	Patient setup	79
4.5	Setting the ventilation mode	82
4.6	Specifying mode settings	85
4.7	Working with alarms	99

4.1 Overview

CAUTION

- *To prevent possible patient injury, make sure the ventilator is set up for the appropriate patient group with the appropriate breathing circuit parts as described in Chapter 2.*
- *To ensure the ventilator's safe operation, always run the required tests and calibrations before using the ventilator on a patient.*
- *To ensure the ventilator's safe operation, always run the preoperational check before using the ventilator on a patient. If the ventilator fails any tests, remove it from clinical use immediately. Do not use the ventilator until necessary repairs are completed and all tests have passed.*
- *It is the clinician's responsibility to ensure that all ventilator settings are appropriate, even when "automatic" features such as ASV or standard settings are used.*

This section explains how to set up the HAMILTON-C3 for ventilation on an individual patient. Prepare the ventilator as instructed in Chapter 2.



When ventilating neonatal patients, see also Chapter 5.

You must be familiar with using the touch screen and using the Press-and-turn knob to select, activate, and confirm parameters. For details, see Section 2.16.

4.2 Patient grouping

The HAMILTON-C3 facilitates the ventilation of your patient by providing two patient groups, neonatal and adult/pediatric.

Table 4-1 Patient groups

Patient group	Neonatal	Adult/pediatric
Initial settings	Weight: 0.2 to 30 kg	Gender: M, F Height: 30 to 250 cm IBW: 3 to 139 kg
Specialties	nCPAP-PS	ASV, Dynamic Lung, Vent Status

4.3 Quick setup settings

The HAMILTON-C3 has three different Quick setup buttons per patient group (Figure 4-1). Mode, mode control settings, graphic selections, alarm settings, Vent Status panel settings, and Vt/IBW or Vt/kg (neonatal) can be stored in each Quick setup.

Figure 4-1 Quick setup buttons (1) in Standby window

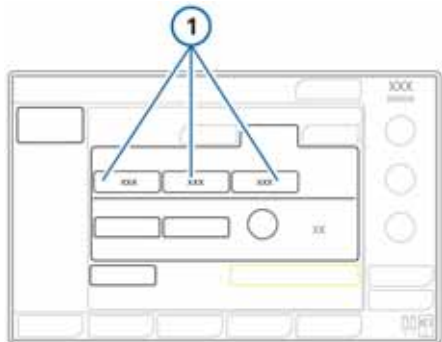

To configure the Quick setup settings, see Section I.6.



- If you select the Neonatal patient group, **Neonatal** appears on the screen.

4.4 Patient setup

WARNING

- Ensure you choose the correct patient group: adult/pediatric or neonatal, and choose the correct gender, if appropriate. Correct selections prevent possible hyper- or hypoventilation.
- For adult and pediatric patient groups, specifying a substantially incorrect height will generate incorrect IBW input, and will lead to a deviation of rate setting. Carefully check the value you specified in the Standby window.

NOTICE

- When setting up for a new patient, the settings you see are the system default settings for mode, control, and the alarm settings.
- If you selected **Last patient**, the settings you see are the last active ventilator parameters in use.
- You can configure default settings for each patient group (mode and controls). See the Configuration chapter.
- If an inadvertent setting is made but has not yet been confirmed, it will automatically be canceled after 30 seconds. Alternatively, the setting window closes after 3 min, again canceling your settings.

After you turn the device on, the patient Standby/Setup window is displayed (Figure 4-2), with default settings selected. Select, adjust, and activate the desired items.

Make sure the ventilator is configured with the appropriate breathing circuit parts, as described in Section 2.3. See also Chapter 5 for additional details about ventilating neonatal patients.

To start ventilation

1. If you have not already done so, select the **Preop check** button and perform the required tests.
2. Select the desired patient group:
 - **Adult/Ped.** For adult and pediatric patients (Figure 4-2). See Table 4-1 for age and weight ranges.
 - **Neonatal.** For neonatal patients. See Table 4-1 for age and weight ranges. See Chapter 5 for details about neonatal ventilation.
 - **Last patient.** Re-use the last active ventilator parameters in use.



The selected patient group (**Adult/Ped.** or **Neonatal**) appears under the Mode name, in the top right corner of the display.

3. Adjust settings as follows:
 - For adult and pediatric patients, select the **Gender** and specify the patient height (**Pat. height**).
The ideal body weight (**IBW**) is automatically calculated and displayed.

The following parameters are based on ideal body weight (IBW): Vt, Rate, T high, T low, and TI, backup settings and safety settings.

- For neonatal patients, adjust the **Weight** setting.

For these patients, the system uses body weight; it does not calculate the IBW.

The following parameters are set based on body weight (neonatal): Vt, Rate, T low, T high, TI, and TI max, backup settings and safety settings.

4. To start ventilating the patient, touch **Start ventilation**.

Figure 4-2 Patient Standby/Setup window (adult/pediatric)

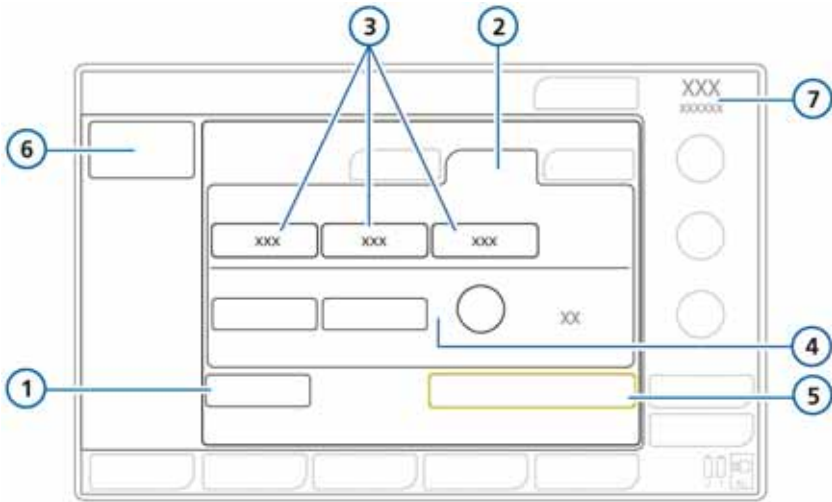

- | | | | |
|---|--------------------------------------|---|---------------------------|
| 1 | Preop check | 5 | Start ventilation |
| 2 | Adult/Ped patient group | 6 | Elapsed time in Standby |
| 3 | Quick setup buttons | 7 | Patient group (Adult/ped) |
| 4 | Gender, Height, and IBW ^a | | |

a. The IBW, based on Pennsylvania Medical Center (adults) and Traub SL. Am J Hosp Pharm 1980 (pediatric patients), is calculated as follows:
 IBW: Ideal Body Weight [kg] BH: Body Height [cm]
 $BH \leq 70 \text{ cm}$ $IBW = 0.125 \times BH - 0.75$ $70 < BH \leq 128$
 $IBW = 0.0037 \times BH^2 - 0.4018 \times BH + 18.62$ $BH \geq 129$
 Male IBW = $0.9079 \times BH - 88.022$, Female IBW = $0.9049 \times BH - 92.006$

4.4.1 Viewing patient ventilation time

The Controls > Patient window displays a timer that shows how long the patient has been ventilated.

Figure 4-3 Ventilation timer

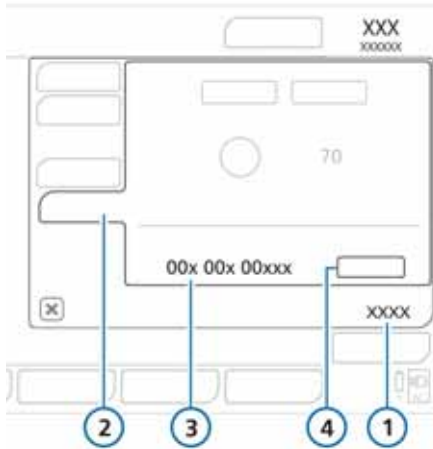

1	Controls	3	Ventilation time (days, hours, minutes)
2	Patient	4	Reset

The timer records time as follows:

- The timer starts when you start ventilation.
- When you enter Standby, the timer pauses. It picks up again from the last value when you exit Standby and return to active ventilation.

- When you select **New Patient** in the Standby/Setup window, and start ventilation, the timer resets to 0.
- When you select **Last Patient** in the Standby/Setup window, the timer continues from the last total time recorded.
- When you touch the **Reset** button, the timer resets to 0.

To get an accurate count of how long a patient has been ventilated, we recommend you reset the timer to 0 once the patient is initially connected to the ventilator.

When the timer is reset, an entry is made to the Event log recording the time of the reset, as well as how long the ventilator had been running prior to the reset.

To reset the timer to 0

1. Open the Controls > Patient window.
2. Touch the **Reset** button.
The timer starts again at 00d 00h 00min.
3. Close the window.

4.5 Setting the ventilation mode

NOTICE



- For additional details on modes, see:
 - Chapter 5 for the neonatal-only mode, nCPAP-PS
 - Appendix C (adaptive support ventilation, ASV)
 - Appendix D (noninvasive ventilation)
 - Appendix B (for all other modes)
 - INTELLiVENT-ASV Operator's Manual*
- ASV and INTELLiVENT-ASV modes are not supported for neonatal patients.

The active ventilation mode is displayed at the top right corner of the display.

When first starting to ventilate a patient, a default mode is pre-selected. You can change it, if needed, as described next.

For details about modes and their controls, see Section 4.6.

To change the mode

- Touch the **Modes** button to open the Modes window. See Figure 4-4.
- Select the mode to change to.
- Touch **Confirm** to select the mode and display the control settings for the selected mode. The Controls window opens.
- Review and, if needed, adjust the control settings (Section 4.6.1.1), and touch **Confirm** in the Controls window to enable the new mode.

The newly selected mode is not active *until* you touch **Confirm** in the Controls window. If you do not touch **Confirm**, the currently active mode remains in place.

Note that the **Confirm** button is only displayed when changing modes.

If the control settings are not confirmed, the window automatically closes after a period of time. The new mode selection will not be valid, and the previous settings remain in effect.

Figure 4-4 Changing the mode, Modes window

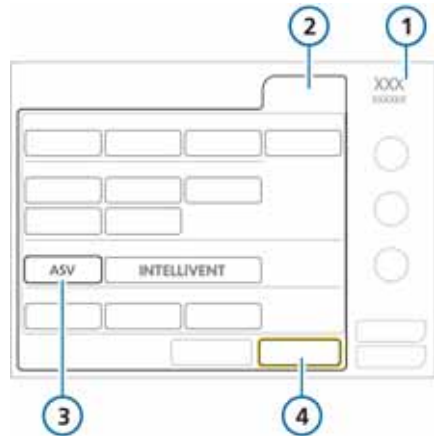

- | | |
|---------------|--|
| 1 Active mode | 3 New mode to apply (ASV, in this example) |
| 2 Modes | 4 Cancel and Confirm buttons |

4.5.1 Working with high flow oxygen therapy

WARNING

- To ensure patient safety, use only interfaces intended for high flow oxygen therapy such as a non-occlusive high flow nasal cannula, a tracheal adapter or a tracheal mask that allow the patient to exhale.
- Always use active humidification during high flow oxygen therapy.
- The ventilator is a high-flow device that can operate at a flow setting up to 80 l/min and with a high oxygen concentration.
- Ensure the ventilator's gas pipeline system does not exceed the pipeline design flow capacity and be aware that if the ventilator gas pipeline system does exceed the pipeline design flow capacity it can interfere with the operation of other equipment using the same gas source.

High flow oxygen therapy¹ is an optional therapy in which a continuous flow of heated and humidified respiratory gases are delivered to the patient. The set flow can vary from 2 to 80 l/min depending on the patient interface. An operating humidifier is required.

For details about the therapy, see Appendix B.

High flow oxygen therapy is indicated for adult, pediatric, and neonatal patients.

To deliver high flow oxygen therapy

1. Set up the patient with an appropriate breathing circuit. Figure 2-6 shows a noninvasive circuit set.

2. Touch the **Modes** button.
3. In the Modes window, touch the **HiFlowO2** mode button, and touch **Confirm**.
The Controls > Basic window opens.
Be sure to carefully read the safety information.
4. Set the desired values for **Oxygen** and **Flow**, then touch **Confirm**.
You can change these settings anytime.
The Standby window is displayed, showing the **Start Therapy** button.

1. Not available in all markets.

5. Touch **Start Therapy** to begin the oxygen therapy.

The main display changes to show Control Flow/Oxygen trend graph, SpO2 trend graph, and a plethysmogram.

Figure 4-5 High flow oxygen therapy display

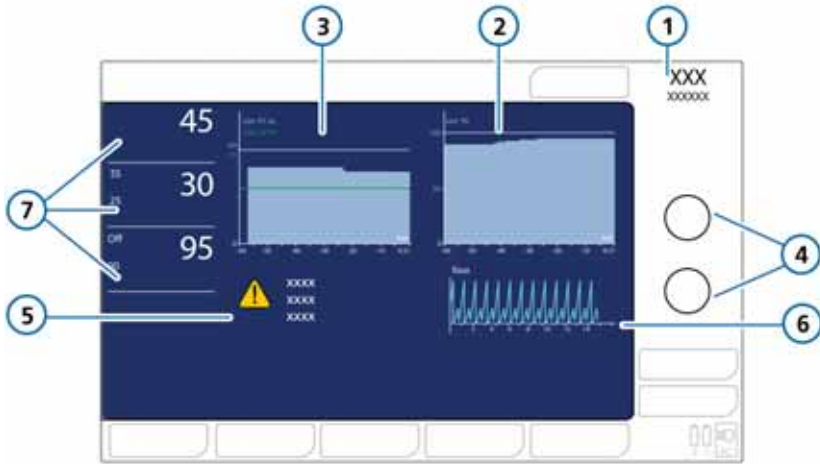

- | | | | |
|---|-------------------------------------|---|--|
| 1 | HiFlowO2 mode active | 5 | Safety information: Hi Flow O2 therapy, No apnea detection, no disconnection detection |
| 2 | SpO2 trend graph | 6 | Plethysmogram |
| 3 | Control Flow and Oxygen trend graph | 7 | MMPs: Control Flow, Oxygen, SpO2 |
| 4 | Flow and Oxygen controls | | |

4.6 Specifying mode settings

NOTICE

- In addition to control settings, the Basic window displays breath timing parameters determined from timing control settings; see Figure 4-7.
- For noninvasive ventilation modes (NIV, NIV-ST), see Appendix D.
- For neonatal modes (including nCPAP-PS), see Chapter 5.



You set controls on four Controls windows: Basic, More, Apnea, TRC.

You enable the Sigh function and other controls through the More window. You can set apnea backup through the Apnea window. The TRC window provides access to tube resistance compensation controls.

For additional information about control parameters, see:

- Table 4-2 defines the control parameter settings.
- Table A-5 describes control parameter ranges and default settings, including accuracy.
- Table A-6 lists control settings applicable to the different ventilation modes.

4.6.1 Changing parameter settings

NOTICE

- You can adjust PEEP/CPAP, Oxygen, and an additional control setting (depending on active mode) from the main display without opening the Controls window.

- When in the process of changing modes, **Confirm** and **Cancel** buttons are also displayed, and the new mode name is shown in the bottom left corner of the Controls window.

The Controls window provides access to the parameter settings used by the active mode, accessible by a variety of tabs.

Which tabs are available depends on which mode is selected, as well as whether you are in Standby or active ventilation.

Figure 4-6 Controls window tabs

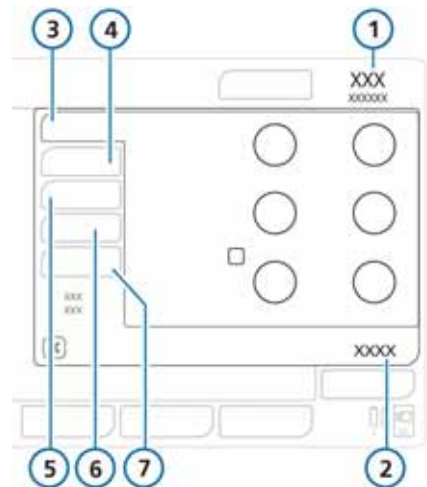

- | | |
|---------------|-----------|
| 1 Active mode | 5 Apnea |
| 2 Controls | 6 TRC |
| 3 Basic | 7 Patient |
| 4 More | |

To change the parameter settings for the active mode

1. Open the Controls > Basic window (Figure 4-7).
2. Select a parameter and adjust the value. The change takes effect immediately. Repeat for any other desired parameters.
For details about changing the trigger type, see Section 4.6.1.1.
3. Touch the **More** tab to open the Controls > More window (Figure 4-7), and select and adjust parameters as desired.
4. If applicable, touch the **Apnea** tab to open the Controls > Apnea window (Figure 4-11). Select or deselect **Backup** as desired.
5. If applicable, touch the **TRC** tab to open the Controls > TRC window (Figure 4-12), select and adjust parameters as desired. See Section 4.6.4.
6. If applicable, touch the **Patient** tab to open the Controls > Patient window, and review/adjust the patient height/gender (weight for neonates).

The **Patient** tab is only available in the Controls window during active ventilation.

During Standby, the patient controls are greyed out in the Standby window and accessible in the patient tab if **Last Patient setup** is selected.

During standby the patient controls are accessible in the Standby window if a new patient set up is selected.

Figure 4-7 Controls window, Basic tab

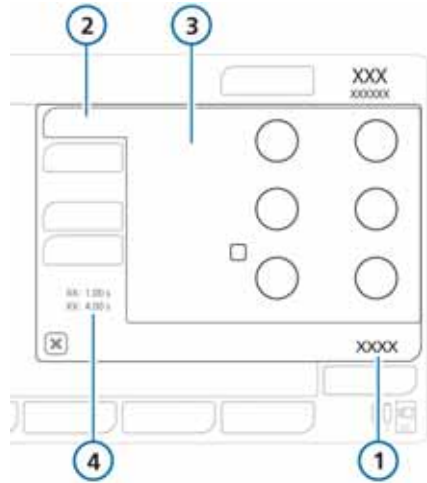

- | | |
|--|--|
| <ol style="list-style-type: none"> 1 Controls 2 Basic 3 Control settings corresponding to the active mode | <ol style="list-style-type: none"> 4 Timing parameters, determined from the timing settings (if control breaths are permitted in selected mode) |
|--|--|

Figure 4-8 Controls window, More tab

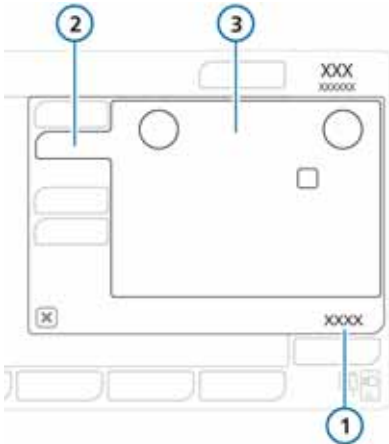

- | | | | |
|---|----------|---|--|
| 1 | Controls | 3 | Control settings corresponding to the mode |
| 2 | More | | |

4.6.1.1 Changing the trigger type

NOTICE

The ambient valve of the HAMILTON-C3 opens at -3 cmH₂O below ambient pressure. Therefore, be sure to set a **Ptrigger** setting above this value to ensure accurate trigger sensitivity. For example, if **PEEP** is set to 5 cmH₂O and **Ptrigger** must be set to no more than -7 cmH₂O (in total, -3 cmH₂O below ambient), to ensure an accurate trigger sensitivity.

Two types of breath triggers are available: flow trigger and pressure trigger. Flow trigger is active by default. For a description of each trigger, see Table 4-2 on page 93.

To change the trigger type

1. Open the Controls > Basic window.
2. Touch the box to the left of the Trigger control to change between the trigger types.

The control label changes between **Flow trigger** and **P trigger**.

Figure 4-9 Trigger selection box

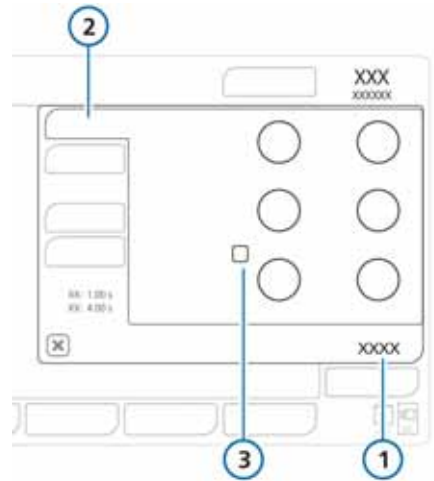

- | | | | |
|---|----------|---|-----------------------|
| 1 | Controls | 3 | Trigger selection box |
| 2 | Basic | | |

3. Adjust the trigger value as needed.
4. Touch the **X** to close the window.

4.6.2 Changing parameter settings with mode change

After selecting a different mode in the Modes window and touching **Confirm**, the Controls > Basic window automatically opens (Figure 4-7), showing the new mode name and parameter settings.

Confirm and **Cancel** buttons are displayed when changing modes, and the new mode name is shown in the bottom left corner of the Controls window.

Review and confirm these proposed settings or the mode change will not be accepted.

Figure 4-10 Mode change

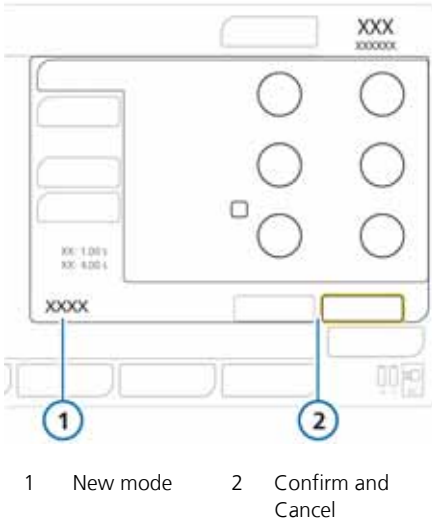

To review and confirm the control settings

1. Select a control and adjust the value. The change takes effect as soon as you confirm the mode change. Repeat for any other desired controls.
2. Make any needed changes in the other applicable windows: More, Apnea, TRC, Patient.
3. Close the Controls window.

4.6.3 About apnea backup ventilation

CAUTION

Hamilton Medical recommends that apnea backup ventilation be enabled whenever a mode that allows spontaneous breathing is selected. For safety reasons, apnea backup is enabled by default.

The HAMILTON-C3 provides apnea backup ventilation, a mechanism that minimizes possible patient injury due to apnea or cessation of respiration. Apnea backup is available in SIMV, APVcmv, DuoPAP, APRV, SPONT, NIV modes.

In these modes, if apnea backup ventilation is enabled, and no inspiratory efforts are detected or control breaths are delivered during an operator-set interval, ventilation will continue.

When apnea backup ventilation is enabled. Apnea backup provides ventilation after the apnea time passes with no breath attempts detected. (You set the **Apnea time** in the Alarms window.) When this occurs, the ventilator automatically and immediately switches into apnea backup ventilation. It generates a low-priority alarm, displays the text, **Apnea ventilation**, and provides ventilation at the following settings:

If the original support mode is...	The ventilator enters this backup mode...
APVsimv (or SIMV+ ^a)	APVsimv (or SIMV+ ^a)
SPONT	APVsimv (or SIMV+ ^a)

If the original support mode is...	The ventilator enters this backup mode...
DuoPAP/APRV	APVsimv (or SIMV+ ^a)
NIV	PCV+
nCPAP-PS	PCV+

a. Set the mode nomenclature to use in Configuration. See Section 1.4.2.

The control setting for the apnea backup mode depends on the ideal body weight (or weight for neonates) of the patient. The default values can be overwritten by disabling the **Automatic** button.

Figure 4-11 Apnea window, Automatic button

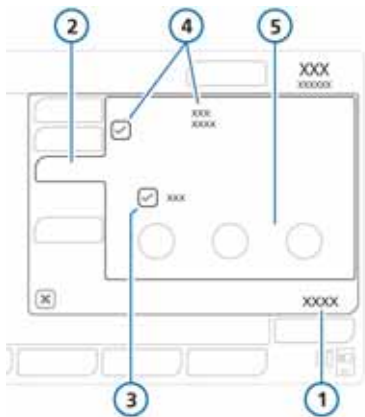

1	Controls	4	Backup check box and mode
2	Apnea	5	Control settings corresponding to the mode
3	Automatic check box		

If the patient triggers two consecutive breaths, the ventilator reverts to ventilation in the original support mode and at the original settings, and it displays Apnea ventilation ended.

Once apnea backup ventilation is enabled or disabled, it retains this status in all applicable modes. Apnea backup ventilation requires no clinician intervention, although you can freely change the mode during apnea backup ventilation, either switching to a new mode or accepting the backup mode as the new mode.

When apnea backup ventilation is disabled, the high-priority Apnea alarm is generated when apnea occurs and there is no patient trigger within the operator-set interval.

4.6.4 Working with tube resistance compensation (TRC)

⚠ WARNING

- To ensure patient safety, check that the pressure alarm limit is set appropriately when using TRC, as real pressure may be higher than the set pressure.
- To prevent patient injury, be especially careful when defining TRC settings, as using the incorrect tube type or size setting can endanger the patient.
- TRC may induce autotriggering. If autotriggering occurs, first check the patient, breathing circuit, and other settings as possible causes before lowering the compensation settings or disabling TRC.

NOTICE

- TRC is intended for use with spontaneously breathing patients.
- When TRC is enabled, the displayed **Ppeak** may be higher than the set PEEP/CPAP plus Pcontrol/Psupport, due to the additional pressure required to work against the tube resistance. Look closely at the calculated tracheal pressure, which is simultaneously displayed as an orange waveform. See Figure 4-13.
- The tracheal pressure waveform displayed is calculated from the proximal flow and pressure signals.
- *100% compensation* indicates that resistance due to the tube itself is compensated. Note that internal resistance (for example, from secretions) and external resistance (for example, from tube kinking) are not compensated.
- Choosing settings that result in over or under compensation of tube resistance can result in hypoventilation or barotrauma.

To reduce the patient's work of breathing while on the HAMILTON-C3, the ventilator's tube resistance compensation (TRC) feature offsets the flow resistance imposed by the endotracheal (ET) or tracheostomy (Trach) tube. TRC is active during inhalation. You can optionally set compensation during exhalation.

The TRC controls are shown in Figure 4-12.

To specify TRC settings or disable TRC

1. Open the Controls -> TRC window (Figure 4-12).
By default, the Disable TRC window appears. To disable TRC, go to step 5.
2. To set the ET tube compensation settings, touch the **ET tube** button (Figure 4-12).
To set the tracheostomy tube compensation settings, touch the **Trach tube** button.
3. Using the **Tube ID** and **Compensate** controls, specify the tube diameter (in mm) and compensation percentage (%) to apply (Figure 4-12).
If the tube is shortened, reduce the compensation percentage.
4. If desired, select the **Expiration** checkbox to activate compensation during exhalation.
5. Touch **Apply** to confirm the settings.

Figure 4-12 TRC controls, Disable TRC selection

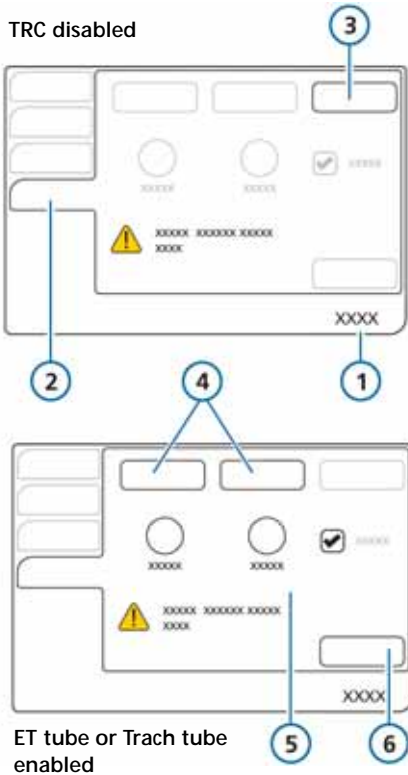

- | | |
|------------|---|
| 1 Controls | 4 ET tube and Trach tube |
| 2 TRC | 5 Tube ID (mm) and Compensate (%) controls, Expiration checkbox |
| 3 Disabled | 6 Apply |

When TRC is enabled, the orange tracheal pressure waveform, **P_{trach}**, is also shown with the yellow airway pressure waveform, **P_{aw}**.

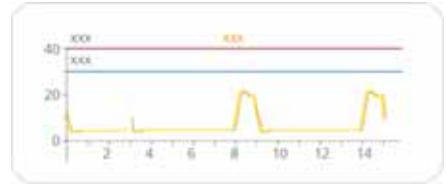
 Figure 4-13 P_{trach} and P_{aw} waveforms, with TRC active

4.6.5 Accessing patient settings during ventilation

Once you have started ventilation, the Controls > Patient window provides the basic patient profile, including gender, height, and time on ventilator (Section 4.4.1).

When in Standby, the patient controls are provided in the Standby window. If ventilating in **Last Patient** setup, these controls are greyed out.

NOTICE

If patient height is changed during active ventilation, controls or alarm limits will not be automatically adapted to the new height setting, except apnea backup controls (if apnea is set to automatic) and start values for safety mode.

Figure 4-14 Controls > Patient window (adult/pediatric)

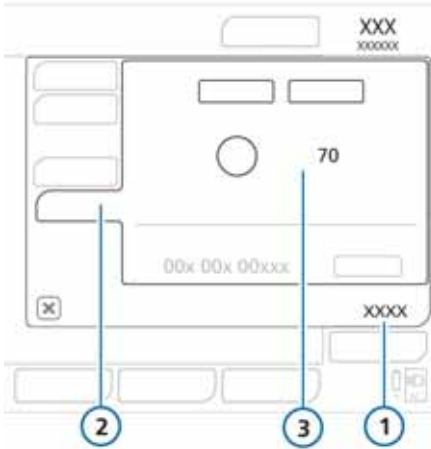

- | | | | |
|---|----------|---|--|
| 1 | Controls | 3 | Adult/pediatric patients: Gender and height settings, and IBW
Neonatal patients: Weight |
| 2 | Patient | | |

4.6.6 Control parameter settings

Table 4-2 briefly describes each of the ventilator control parameters.

Table A-5 in Appendix A provides the control parameter ranges and default settings, including accuracy.

To change patient data during ventilation

1. Open the Controls > Patient window.
2. Adjust settings as needed.

Table 4-2 Control parameters

Parameter	Definition
<i>For additional details, including parameter ranges and accuracy, see Table A-5 on page 213.</i>	
Apnea backup	<p>A function that provides ventilation after the adjustable apnea time passes without breath attempts.</p> <p>If Automatic is enabled, control parameters are calculated based on the patient's IBW.</p> <p>Applies in APVsimv (SIMV+), SPONT, NIV, APRV, and DuoPAP.</p>
ETS	<p>Expiratory trigger sensitivity. The percent of peak inspiratory flow at which the ventilator cycles from inspiration to exhalation.</p> <p>Increasing the ETS setting results in a shorter inspiratory time, which may be beneficial in patients with obstructive lung disease. The ETS setting lets you match the inspiratory time of pressure-supported breaths to the patient's neural timing.</p> <p>Applies to spontaneous breaths.</p>
%MinVol	<p>Percentage of minute volume to be delivered in ASV mode. The ventilator uses the %MinVol, Pat. height, and Gender settings to calculate the target minute ventilation.</p> <p>Add 20% per degree of body temperature > 38.5°C (101.3°F)</p> <p>Add 5% per 500 m (1640 ft) above sea level</p>
Flow	<p>In high flow oxygen therapy, Flow is the continuous and constant flow of medical gas to the patient in litres per minute.</p>
Flow pattern	<p>Flow pattern for gas delivery.</p> <p>This is not affected by patient pressure or other limitations as long as the peak inspiratory flow or pressure limit is not exceeded.</p> <p>Applies to volume-controlled mandatory breaths.</p>
Gender	<p>Sex of patient. Used to compute ideal body weight (IBW) for adults and pediatrics.</p>
I:E	<p>Ratio of inspiratory time to expiratory time.</p> <p>Applies to mandatory breaths, and in APVcmv and PCV+.</p>
Oxygen	<p>Oxygen concentration to be delivered.</p> <p>Applies to all breaths. Not active when low-pressure oxygen is used.</p>

Table 4-2 Control parameters (continued)

Parameter	Definition
<i>For additional details, including parameter ranges and accuracy, see Table A-5 on page 213.</i>	
Pasvlimit	The maximum pressure to apply in ASV mode. For the ASV controller to function correctly, Pasvlimit must be at least 15 cmH ₂ O above PEEP/CPAP. Changing Pasvlimit or the Pressure alarm limit automatically changes the other: The Pressure alarm limit is always 10 cmH ₂ O greater than Pasvlimit.
Pat. height	Patient height. It determines the ideal body weight (IBW), which is used in calculations for ASV and startup settings for adult and pediatric patients.
Pause	Inspiratory pause or plateau, as a percentage of total breath cycle time. After the required gas is delivered (after the operator-set V _t is reached), gas remains in the lungs and exhalation is blocked during the Pause time. The use of a Pause increases the residence time of gas in the patient's lungs. Applies to volume-controlled mandatory breaths, when the device is configured in this way.
Peak flow	Peak (maximum) inspiratory flow. Applies to volume-controlled mandatory breaths, when the device is configured in this way.
Pcontrol	The pressure (additional to PEEP/CPAP) to apply during the inspiratory phase in PCV+, PSIMV+ modes.
PEEP/CPAP	Positive end expiratory pressure and continuous positive airway pressure, baseline pressures applied during the expiratory phase. Applies to all breaths, except in APRV.
P high	The high pressure setting in APRV and DuoPAP modes. Absolute pressure, including PEEP.
Pinsp	Pressure (additional to PEEP/CPAP) to apply during the inspiratory phase. Applies in PSIMV+ PSync, NIV-ST, and nCPAP-PS.
P low	The low pressure setting in APRV.

Table 4-2 Control parameters (continued)

Parameter	Definition
<i>For additional details, including parameter ranges and accuracy, see Table A-5 on page 213.</i>	
P-ramp	<p>Pressure ramp. Time required for inspiratory pressure to rise to the set (target) pressure.</p> <p>The P-ramp setting lets you fine-tune the initial flow output during a pressure-controlled or pressure-supported breath to match the ventilator flow to the patient's demand.</p> <p>Short P ramp settings (0 to 50 ms) provide higher initial flow rates and result in faster attainment of the target pressure. This may benefit patients with elevated respiratory drive.</p> <p>Lower P-ramp values have been correlated with reduced work of breathing in certain patients.</p> <p>Setting the P-ramp too low, especially in combination with a small ET tube (high resistance), may result in a noticeable pressure overshoot during the early stage of inspiration and a Pressure limitation alarm.</p> <p>Setting the P-ramp too high may prevent the ventilator from attaining the set inspiratory pressure. A square (rectangular) pressure profile is the goal.</p> <hr/> <p>Applies to all breaths.</p> <div data-bbox="367 858 553 898" style="background-color: #0070C0; color: white; padding: 2px;">NOTICE</div> <p>To prevent possible pressure overshoot in pediatric applications, it is recommended that P-ramp be set to at least 75 ms.</p>
Psupport	<p>Pressure support for spontaneous breaths in SPONT, NIV, APVsimv (SIMV+), and DuoPAP modes. It is the pressure (additional to PEEP/CPAP) to apply during the inspiratory phase.</p> <p>Pressure support helps the patient counteract the flow resistance of the breathing circuit and endotracheal tube. It compensates for the decreasing tidal volume and rising respiratory rate of a spontaneously breathing patient.</p>
Rate	Respiratory frequency or number of breaths per minute.

Table 4-2 Control parameters (continued)

Parameter	Definition
<i>For additional details, including parameter ranges and accuracy, see Table A-5 on page 213.</i>	
Sigh	<p>Breaths delivered at a regular interval (every 50 breaths) at a pressure up to 10 cmH₂O higher than non-sigh breaths, as allowed by the Pressure alarm limit.</p> <p>During sigh breaths, the Pressure and Vt alarm limits remain in effect to help protect the patient from excessive pressures and volumes.</p> <p>Not available for neonatal patients, or DuoPAP or APRV modes.</p>
TRC-related settings	<p>Tube resistance compensation. Reduces the patient’s work of breathing by offsetting tube resistance.</p> <hr/> <p>NOTICE</p> <p>If autotriggering occurs, first check the patient, breathing circuit, and other settings as possible causes before lowering the compensation percentage or disabling TRC.</p> <hr/>

Table 4-2 Control parameters (continued)

Parameter	Definition
<i>For additional details, including parameter ranges and accuracy, see Table A-5 on page 213.</i>	
Trigger	<p>Flow trigger</p> <p>The patient's inspiratory flow that triggers the ventilator to deliver a breath.</p> <p>Changing the setting during the inspiratory phase affects the next breath. During the expiratory phase, affects the breath after the next breath.</p> <p>Applies to all breaths.</p> <p>Pressure trigger</p> <p>The drop in airway pressure when the patient tries to inhale triggers the ventilator to deliver a breath.</p> <p>Changing the setting during the inspiratory phase affects the next breath. During the expiratory phase, affects the breath after the next breath.</p> <p>Applies to all breaths.</p> <p>For details on selecting the trigger to use, see Section 4.6.1.1.</p> <hr/> <p>CAUTION</p> <p><i>If auto-triggering occurs, first check the patient, breathing circuit, and other settings as possible causes before decreasing the trigger sensitivity.</i></p> <hr/> <p>NOTICE</p> <p>If the trigger is set higher than the patient is able to meet, a breath cannot be triggered. Reset the trigger to an achievable value, adjusting the sensitivity of the trigger to the patient's ability.</p> <hr/>
Tube type, Disable TRC	Options are: ET (endotracheal) tube, Trach (tracheostomy) tube, Disable TRC (TRC off)
Tube ID	Inner diameter of the tube, in mm.
Compensate	Compensation percentage (%).
Expiration	Activate compensation during exhalation.
T high	Length of time at the higher pressure level, P high, in DuoPAP and APRV modes.

Table 4-2 Control parameters (continued)

Parameter	Definition
<i>For additional details, including parameter ranges and accuracy, see Table A-5 on page 213.</i>	
TI	<p>Inspiratory time, the time to deliver the required gas (time to reach the operator-set Vt or Pcontrol value). Used with Rate to set the breath cycle time.</p> <p>Applies in PCV+, APVcmv ((S)CMV+), APVsimv (SIMV+), PSIMV+, NIV-ST, and nCPAP-PS.</p> <p>In PCV+ and APVcmv modes, TI can be controlled by rate and TI or by the I:E ratio; you set the desired method in Configuration. All other modes are controlled by rate and TI.</p>
Tip	<p>Inspiratory pause or plateau time.</p> <p>After the required gas is delivered (after the operator-set Vt is reached), gas remains in the lungs and exhalation is blocked during the Tip time.</p> <p>The use of a Tip increases the residence time of gas in the patient's lungs.</p> <p>Applies to volume-controlled mandatory breaths, when the device is configured in this way.</p>
TI max	Maximum inspiratory time for flow-cycled breaths in NIV, NIV-ST, and SPONT in neonatal modes, as well as the neonatal mode, nCPAP-PS.
T low	Length of time at the lower pressure level, P low, in APRV mode.
Vt	Tidal volume delivered during inspiration in APVcmv ((S)CMV+) and APVsimv (SIMV+) modes.
VT/kg	Tidal volume per weight.
Weight 	Actual body weight. Used only with neonates.

4.7 Working with alarms

WARNING

Be sure to set the auditory alarm volume above the ambient sound level. Failure to do so can prevent you from hearing and recognizing alarm conditions.

Use the Alarms window to:

- Set alarm limits (Section 4.7.1)
- View active alarms (Section 4.7.3)
- View on-screen help for troubleshooting

Use the System window to:

- Adjust the alarm volume (Section 4.7.2)

Details about device alarms are provided as follows:

- Table 4-3 describes each of the adjustable alarms
- Table 8-2 in Chapter 8 provides troubleshooting details
- Table A-8 in Appendix A provides ranges and accuracy information

4.7.1 Setting alarm limits

CAUTION

- *Although you can set all alarms quickly using the Auto alarm function, some settings are not appropriate under all clinical conditions. Hamilton Medical recommends that you set the alarms manually when possible. When circumstances require use of the Auto alarm function, verify the validity of the settings at the earliest opportunity. Not active for neonates.*

- *To prevent possible patient injury, make sure the alarm limits are appropriately set before you place the patient on the ventilator.*

NOTICE

- If the ventilator is in the APVcmv ((S)CMV+), or APVsimv (SIMV+) mode, be sure the Pressure alarm is appropriately set. This alarm provides a safety pressure limit for the device to appropriately adjust the inspiratory pressure necessary to achieve the target tidal volume.

The maximum available inspiratory pressure is 10 cmH₂O below the Pressure limit, indicated by a blue line on the pressure waveform display.

Set Pressure to a safe value (e.g., 45 cmH₂O, which limits the pressure target to a maximum of 35 cmH₂O). If Pressure is set too low, there may not be enough margin for the device to adjust its inspiratory pressure in order to deliver the target tidal volume.

- Selecting **Auto** automatically sets all alarm limits around the current monitoring parameter values, except for the Vt and Apnea alarm limits. The Vt alarm limits remain unchanged, and must be set manually to the desired level.
- The **Auto** button is disabled during neonatal ventilation.

- After power has been interrupted for up to 120 seconds, the device stores the last settings, including any specified alarm limits. Upon reconnection with the power supply, the device resumes ventilation with these stored settings. Should the power failure exceed 120 seconds, the settings are still stored but the device starts in standby upon reconnection with the power supply.

You can access the Alarms window and change alarm settings at any time, without affecting ventilation.

The device offers two alarm-setting options:

- Manually set individual alarm limits.
- Use the **Auto** alarm function.

Figure 4-15 Limits window

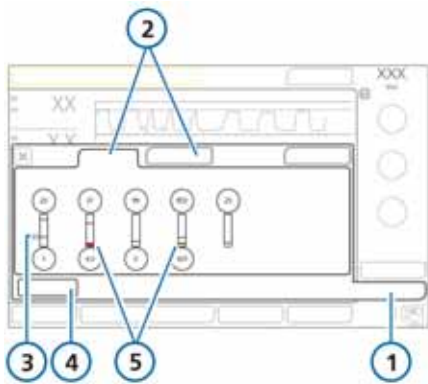

- | | |
|---------------------------|---|
| 1 Alarms | 4 Auto button |
| 2 Limits 1, 2 | 5 Red or yellow bar (depending on alarm priority) indicates the monitored value is out of range |
| 3 Current monitored value | |

To review and adjust alarms

1. Touch the **Alarms** button.
The Limits 1 window is displayed (Figure 4-15).
2. To set an alarm individually, select the alarm control and adjust the value. Repeat for any other alarm.
Additional alarm settings are available in the Limits 2, and if used, Limits 3 windows.
3. To set alarm limits automatically, select the **Auto** button in the Limits 1 window.
Selecting **Auto** automatically sets all alarm limits around the current monitoring parameter values, except for the Vt and apnea alarm limits. The Vt alarm limits remain unchanged, and must be set manually to the desired level.
4. Close the window.

4.7.2 Adjusting alarm loudness (volume)

⚠ WARNING

Be sure to set the auditory alarm loudness above the ambient sound level. Failure to do so can prevent you from hearing and recognizing alarm conditions.

NOTICE

- The alarm loudness cannot be set lower than the minimum specified for the device in Configuration (Section I.3.3).
- If the alarm loudness was set to a value that is below the default setting (5 for adult/ped, 3 for neonates) before the ventilator was turned off, it will be reset to 5 (adult/ped) or 3 (neonates) when the ventilator is turned back on.
- However, if the minimum loudness setting is configured and is set to a value greater than 5, the higher value is retained.

To adjust the alarm loudness

1. Open the System -> Settings window.
2. Activate and adjust the **Loudness** control, as needed.
3. Touch **Test** to check the loudness level.
Ensure the loudness level is above the ambient sound level.
4. Repeat the process as required, and close the window.

4.7.3 Buffer: Viewing alarm information and on-screen help

See Chapter 8, section 8.3 for a description of the alarm buffer and Chapter 8, section 8.3.1 for on-screen help.

4.7.4 Table of alarm limit settings

The following table briefly describes each of the adjustable ventilator alarms. Table A-8 in Appendix A provides the adjustable alarm ranges and default settings, including accuracy.

Figure 4-16 Alarm loudness control

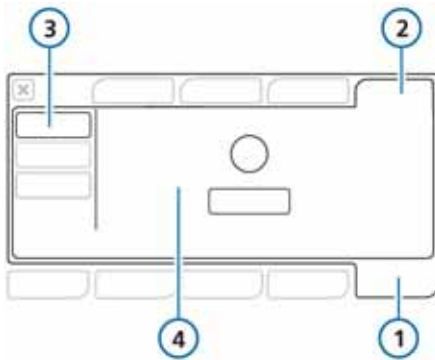

- | | |
|------------|------------------------------------|
| 1 System | 3 Loudness |
| 2 Settings | 4 Loudness control and Test button |

Table 4-3 Adjustable alarms

Alarm ^a	Definition
<i>For additional details, including alarm ranges and accuracy, see Table A-8 on page 224.</i>	
Apnea time	<p>The maximum time allowed from the beginning of one inspiration to the beginning of the next inspiration. If the patient does not trigger a breath during this time, an alarm sounds. Apnea backup ventilation will begin, if enabled.</p> <p>The Apnea alarm can be turned off.</p>
ExpMinVol (low and high)	<p>Low and high expiratory minute volume. If either limit is reached, a high-priority alarm is annunciated.</p>
fTotal (low and high)	<p>Low and high monitored total breath rate (fTotal), including both spontaneous and mandatory breaths. If either limit is reached, a medium-priority alarm sounds.</p>
Oxygen (low and high)	<p>Low and high monitored oxygen concentration (Oxygen). If either limit is reached, a high-priority alarm sounds.</p> <p>Applies only when low-pressure oxygen is used.</p>
PetCO ₂ (low and high)	<p>Low and high monitored PetCO₂. If either limit is reached, a medium-priority alarm sounds.</p>
Pressure (low and high)	<p>Low and high monitored pressure at the patient airway (Ppeak). If pressure (high) is reached or pressure (low) is not reached, a high-priority alarm sounds.</p> <p>In addition, when pressure (high) reaches Pressure minus 10 cmH₂O, pressure is limited: no further pressure is applied. If pressure (high) is reached, the ventilator immediately stops gas flow to the patient and opens the expiratory valve to reduce pressure to the PEEP/CPAP level. The ventilator is designed to limit patient airway pressure to 60 cmH₂O, but if pressure climbs to 75 cmH₂O, the ambient valve opens, releasing pressure to the ambient level.</p> <p>An exception is sigh breaths, when the ventilator may apply inspiratory pressure 3 cmH₂O below the Pressure alarm limit.</p>

Table 4-3 Adjustable alarms (continued)

Alarm ^a	Definition
<i>For additional details, including alarm ranges and accuracy, see Table A-8 on page 224.</i>	
Vt (low and high)	<p>Low and high expiratory tidal volume, for two consecutive breaths. If either limit is reached, a medium-priority alarm sounds.</p> <p>When the delivered Vt is > 1.5 times the set Vt high alarm, the Inspiratory volume limitation alarm is generated.</p> <p>In this case, the device aborts the breath and reduces the pressure to PEEP level.</p> <p>The APV controls reduce the pressure for the next breath by 3 cmH2O.</p>

- a. For SPO2 alarms refer to *Pulse Oximetry Instructions for Use*. For INTELLiVENT alarms refer to *INTELLiVENT-ASV Operator's manual*.

5

Neonatal ventilation

5.1	Overview	106
5.2	Setting up for neonatal ventilation.	106
5.3	Ventilation modes for neonates.	116
5.4	Parameters for neonatal ventilation	116
5.5	Alarms for neonatal ventilation	117
5.6	O2 enrichment for neonates	118



5.1 Overview

WARNING

- To prevent possible patient injury, make sure the ventilator is set up correctly for the neonatal patient. The ventilator must have the appropriate breathing circuit parts and neonatal-pediatric flow sensor.
- Make sure you perform all tests and calibrations before using the ventilator.
- If the ventilator fails any tests, remove it from clinical use immediately. Do not use the ventilator until necessary repairs are completed and all tests have passed.
- It is the clinician's responsibility to ensure that all ventilator settings are appropriate, even when or standard settings are used.

CAUTION

To prevent increased PaCO₂ do not use an adult airway adapter for neonates as it will increase dead space.

NOTICE

- When changing from an Adult/Pediatric to a Neonatal patient group or vice versa, you must calibrate the flow sensor and perform the tightness test.
- After connecting a new or decontaminated breathing circuit or component, perform a tightness test and calibrate the flow sensor.
- Pneumatic nebulization is disabled during neonatal ventilation.

- Circuit resistance compensation is measured during calibration.

While the process for ventilating neonates is very similar to that for other patients, neonatal ventilation presents some unique challenges and requirements. This chapter provides a comprehensive overview of these requirements and special conditions.

5.2 Setting up for neonatal ventilation

Setting up for neonatal ventilation comprises the following steps:

	See
1. Install the expiratory valve.	Section 2.4.1
2. On the ventilator, select the patient group and specify weight.	Section 5.2.1
3. Select the ventilation mode.	Section 5.2.2
4. Set up the breathing circuit.	Section 5.2.3
5. Perform any required tests (tightness test and calibrations) and the preoperational check.	Section 5.2.4

5.2.1 Setting the patient group and weight

You select the patient group and weight on the Standby/Setup window when first setting up the ventilator for the patient.

Figure 5-1 Neonatal Standby window: Selecting neonatal patient group and weight

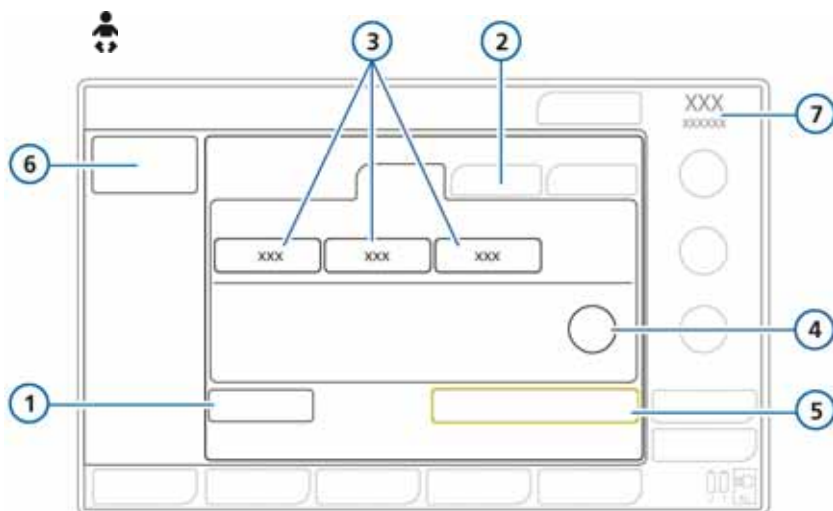

- | | | | |
|---|------------------------|---|--------------------------|
| 1 | Preop check | 5 | Start ventilation |
| 2 | Neonatal patient group | 6 | Elapsed time in Standby |
| 3 | Quick setup buttons | 7 | Patient group (Neonatal) |
| 4 | Weight | | |

To select the patient group

1. In the Standby window, touch the **Neonatal** tab. See Figure 5-1.
2. Touch the appropriate Quick setup button.
By default, they are labeled **Neonatal 1**, **Neonatal 2**, and **Neonatal 3**. The Quick setup names and settings are defined in configuration (Section I.6). Mode, mode control settings, graphic selections, alarm settings, Vent Status panel settings, and **Vt/kg** can be stored in each neonatal patient Quick setup.

3. Touch the **Weight** control and set the patient's body weight.
Setting the weight properly is *critical* for ensuring the correct setting of:
 - Tidal volume and minute volume alarms
 - Apnea backup
 - Safety ventilation

By default, the weight is set to 2 kg.

You can now select the ventilation mode, if the desired mode is not already selected.

5.2.2 Selecting the ventilation mode

The device provides a full spectrum of volume controlled, pressure controlled, and noninvasive modes, including High flow oxygen therapy for neonatal patients.

For detailed information about each mode, see Appendix B.

To select the ventilation mode

1. Touch the **Modes** button at the top right of the display.
The Modes window appears.

Figure 5-2 Neonatal modes

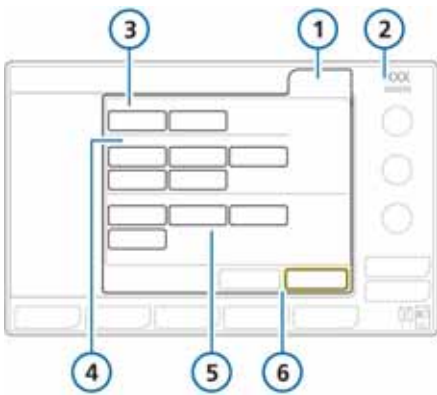

- | | |
|---------------------------|-----------------------------|
| 1 Modes | 4 Pressure controlled modes |
| 2 Active mode | 5 Noninvasive modes |
| 3 Volume controlled modes | 6 Confirm, Cancel |

2. Touch the desired mode and touch **Confirm**.
The Controls window for the selected mode appears.

3. Set the desired parameter values in the various tabs (Basic, More, Apnea, TRC) as appropriate and available, and touch **Confirm**.
4. Touch the **Alarms** button and set the appropriate alarm limits in the Alarms > Limits 1 and Limits 2 windows (Figure 4-15).

The device is ready for the appropriate pre-operational checks and calibrations.

5.2.3 Setting up the breathing circuit

Setting up a neonatal breathing circuit comprises the following steps:

Table 5-1 Assembling the breathing circuit

		See
1	Selecting the components	Section 5.2.3.1
2	Connecting the breathing circuit	Section 5.2.3.2
3	Connecting the flow sensor	Section 5.2.3.3
4	Positioning the circuit	Section 5.2.3.4

5.2.3.1 Components for neonatal ventilation

CAUTION

- To determine appropriate tidal and minute volumes for neonatal patients, you must consider (anatomic) dead space. Artificial airways (Y-piece, flow sensor, ET tube, CO2 airway adapter, etc.) may increase the dead space.

- Always use the correct neonatal CO₂ adapter that minimises dead space. In neonatal patients, large geometrics detain effective CO₂ removal.
- A breathing circuit with a heating wire may noticeably increase the inspiratory resistance of the neonatal breathing circuit.
- When using active humidification, prevent water accumulation in the flow sensor by ensuring that the flow sensor is positioned at a $\geq 45^\circ$ angle relative to the floor. Excess water can affect the flow sensor measurements and lead to inaccurate volume delivery, potentially resulting in hypoventilation.

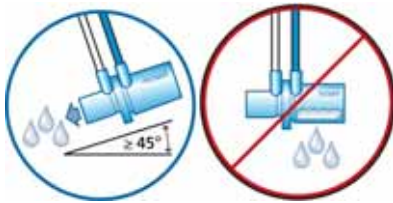

NOTICE

- A neonatal-pediatric flow sensor is required with breathing circuits used for all ventilation modes.
- The neonatal-pediatric flow sensor was previously referred to as the *infant flow sensor*.

Select the correct breathing circuit parts for your patient from Table 5-2 and Table 5-3.

Table 5-2 Neonatal breathing circuit part specifications

Patient Group:	Neonatal
Weight (kg)	0.2 to 30
Tracheal tube ID (mm)	≤ 4
Breathing circuit tube ID (mm)	12
Flow sensor	Neonatal-pediatric
CO ₂ airway adapter	Neonatal

Table 5-3 Tracheal tubes and CO₂

Tracheal tube ID (mm)	CO ₂ airway adapter
≤ 4	Neonatal

5.2.3.2 Connecting the neonatal breathing circuit

Figures 5-3 and 5-4 show typical breathing circuits using a humidifier or an HME/HMEF, applicable to most ventilation modes. Figure 5-5 shows a typical breathing circuit for use with the nCPAP-PS mode.

For ordering information, contact your Hamilton Medical representative. Follow the specific guidelines for the different parts.

Connect the components as appropriate for your patient.

Figure 5-3 Dual-limb breathing circuit with humidifier (neonatal)

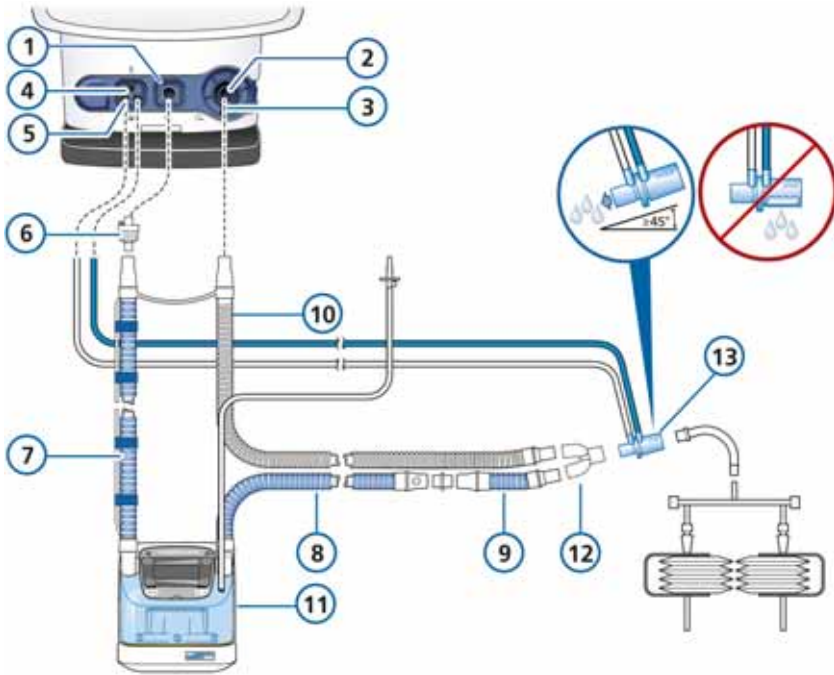

- | | | | |
|---|--|----|--|
| 1 | To patient | 8 | Heated inspiratory limb with temperature sensor to patient |
| 2 | From patient | 9 | Unheated inspiratory limb extension for use in incubator |
| 3 | Expiratory valve (with membrane cover) | 10 | Expiratory limb |
| 4 | Nebulizer outlet | 11 | Humidifier |
| 5 | Flow sensor connectors | 12 | Y-piece |
| 6 | Bacteria filter | 13 | Flow sensor (neonatal-pediatric) |
| 7 | Inspiratory limb to humidifier | | |

CAUTION: When using active humidification, prevent water accumulation in the flow sensor by ensuring that the flow sensor is positioned at a $\geq 45^\circ$ angle relative to the floor.

Figure 5-4 Dual-limb breathing circuit with HMEF/HME (neonatal)

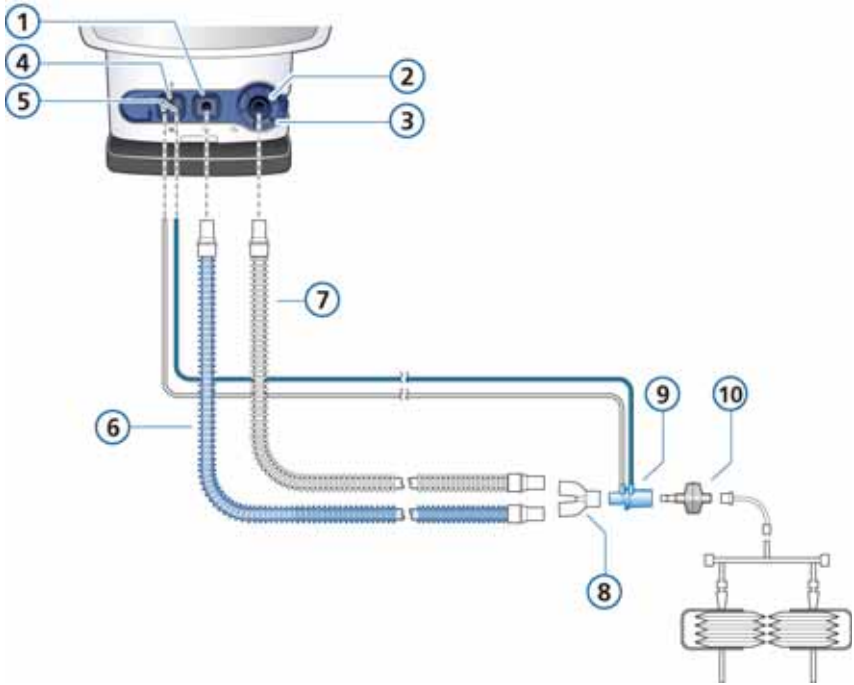

- | | | | |
|---|--|----|----------------------------------|
| 1 | To patient | 6 | Inspiratory limb |
| 2 | From patient | 7 | Expiratory limb |
| 3 | Expiratory valve (with membrane cover) | 8 | Y-piece |
| 4 | Nebulizer outlet | 9 | Flow sensor (neonatal-pediatric) |
| 5 | Flow sensor connectors | 10 | HMEF/HME (neonatal) |

Figure 5-5 Breathing circuit with humidifier, for nCPAP-PS (neonatal)

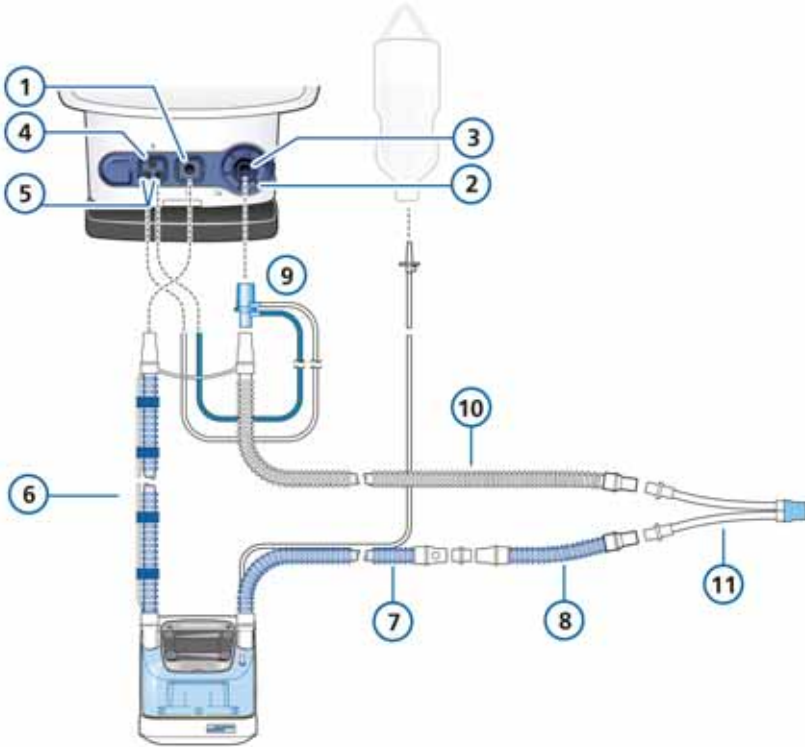

- | | | | |
|---|--|----|--|
| 1 | To patient | 7 | Heated inspiratory limb with temperature sensor to patient |
| 2 | From patient | 8 | Unheated inspiratory limb extension for use in incubator |
| 3 | Expiratory valve (with membrane cover) | 9 | Flow sensor (connected at expiratory valve) |
| 4 | Nebulizer outlet | 10 | Expiratory limb |
| 5 | Flow sensor connectors | 11 | Patient interface |
| 6 | Inspiratory limb to humidifier | | |

NOTE: The flow sensor is connected at the expiratory valve for nCPAP-PS mode. During calibration, however, the flow sensor is placed after the Y-piece, in the same manner as for all other modes. See Section 5.2.4.1.

5.2.3.3 Connecting the flow sensor

NOTICE

- To prevent inaccurate flow sensor readings, make sure the flow sensor is correctly installed. The flow sensor tubes must not be kinked.
- When using the nCPAP-PS mode, the flow sensor is connected to the expiratory limb at the expiratory valve on the ventilator. See Figure 5-5.

Use a Hamilton Medical neonatal-pediatric flow sensor to ventilate your neonatal patient. Do not use an adult flow sensor. The neonatal flow sensor has a dead space of < 1.3 ml.

To connect the neonatal-pediatric flow sensor

1. For all modes except nCPAP-PS, insert a flow sensor between the Y-piece of the breathing circuit and the patient connection (Figure 5-6).

Figure 5-6 Connecting the neonatal-pediatric flow sensor

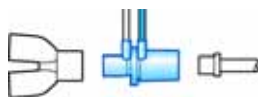

When using the nCPAP-PS mode, insert the flow sensor between the end of the expiratory limb and the expiratory valve on the ventilator (Figure 5-7).

Figure 5-7 Connecting the flow sensor to expiratory valve, nCPAP-PS mode



2. Connect the blue and clear tubes to the flow sensor connectors on the ventilator.
The blue tube connects to the blue connector. The clear tube connects to the silver connector.
3. Calibrate the flow sensor. See Section 5.2.4.1.

5.2.3.4 Positioning the breathing circuit

After assembly, position the breathing circuit so that the hoses will not be pushed, pulled, or kinked as a result of a patient's movement, nebulization, or other procedures.

5.2.4 Performing tests and calibrations

Be sure to perform a tightness test, and flow sensor or breathing circuit calibration, in addition to the preoperational checks. See Chapter 3 for details, as well as additional tests and procedures, for example, O₂ cell and CO₂ sensor calibration.

This section describes the following basic tests and calibrations required for neonatal ventilation.

Table 5-4 Tests and calibrations

	See
1 Perform the preoperational check	Section 3.2 in Chapter 3
2 Perform the tightness test	Section 3.3.2.1 in Chapter 3
3 Calibrate the neonatal-pediatric flow sensor	Section 5.2.4.1

5.2.4.1 Calibrating the neonatal-pediatric flow sensor

NOTICE

- A flow sensor is required with breathing circuits used for all ventilation modes.
- Make sure another source of ventilatory support is available during this calibration. The patient must be disconnected from the ventilator during the test.
- During calibration, the flow sensor is always placed after the Y-piece, regardless of which ventilator mode is selected.

If you are using the nCPAP-PS mode, where the flow sensor is connected directly to the expiratory valve during ventilation, be sure to calibrate the flow sensor with it at the patient end of the breathing circuit, after the Y-piece.

- To cancel flow sensor calibration while it is in progress, select **Flow Sensor** again.

- If there is a mismatch between the active patient profile and the flow sensor type you are using, the calibration fails. Ensure you are using the correct flow sensor for the patient.

Calibrate the flow sensor after connecting a new flow sensor or whenever the **Flow sensor calibration needed** alarm is generated.

Procedure: To calibrate the neonatal-pediatric flow sensor

1. Set the ventilator up as for normal ventilation, complete with breathing circuit and expiratory membrane and cover.
2. Make sure that the Neonatal patient group is selected, a neonatal-pediatric flow sensor is installed at the patient end of the breathing circuit, and the calibration adapter is available.
3. In the System -> Tests & calib window, select **Flow Sensor**.
If you have not already disconnected the patient, the text **Disconnect patient** is displayed.
4. Disconnect the patient now.



5. Follow the instructions displayed in the message line:
 - a. Attach the calibration adapter to the patient end of the flow sensor.



- b. When prompted, turn the flow sensor around as indicated and attach the calibration end to the Y-piece.



6. When prompted to turn the flow sensor again, remove the calibration adapter, and turn the flow sensor back to its starting position.



7. When calibration is complete, verify that there is a green checkmark in the **Flow sensor** checkbox.
8. If the calibration is successful, connect the patient, and touch the **Start ventilation** button in the Standby window to start ventilation.

In case of calibration failure

If the calibration fails, a red X is displayed in the **Flow sensor** checkbox.

Perform the following checks, repeating the calibration after each one, until calibration is successful:

- Check the breathing circuit and flow sensor tubing for a disconnection between the ventilator and the flow sensor, or for other large leaks (for example, breathing circuit, humidifier).
- Check that the correct flow sensor is connected, and that the flow sensor and expiratory valve/membrane are properly seated.
- If the calibration fails again, replace the flow sensor.
- If the calibration still fails, replace the expiratory valve/membrane.

If the problem persists, have the ventilator serviced.

5.2.5 Performing the preoperational check

⚠ CAUTION

- *To ensure the ventilator's safe operation, always run the full preoperational check before using the ventilator on a patient. If the ventilator fails any tests, remove it from clinical use immediately. Do not use the ventilator until necessary repairs are completed and all tests have passed.*
- *To prevent possible patient injury, disconnect the patient from the ventilator before running this test. Make sure another source of ventilatory support is available.*

When to perform: Before placing a new patient on the ventilator.

Required materials: To ensure that the ventilator also functions according to specifications on your patient, we recommend that your test circuit be equivalent to the circuit used for ventilation.

Table 5-5 Breathing circuit recommendations

Breathing circuit	Neonatal, 12 mm ID with 12F connectors
Flow sensor	Neonatal-pediatric
Test lung	Neonatal, with neonatal ET tube between flow sensor and lung model (an IngMar neonatal lung model is recommended)

Procedure:

For instructions on performing the preoperational checks, see Section 3.2 in Chapter 3.

5.3 Ventilation modes for neonates

CAUTION

Auto triggering is harmful and can occur easily with sensitive trigger settings due to gas leaks around the ET tubes.

NOTICE

- Because neonatal ET tubes often do not have a cuff, leakage can be significant, that is, the inspiratory tidal volume (VTI) can be much greater than the measured expiratory tidal volume (VTE).

- Check the VLeak parameter in the Monitoring window from time to time; the leak may not be predictable.

The neonatal modes available in the HAMILTON-C3 are either pressure controlled or adaptive (pressure regulated and volume targeted) modes.

For the list of supported modes and details about each one, see Appendix B.

5.4 Parameters for neonatal ventilation

WARNING

- Prolonged exposure to high oxygen concentrations may cause irreversible blindness and pulmonary fibrosis in preterm neonates.
- High rate settings, or very short TI or TE may cause incomplete inspiration or expiration.

NOTICE

- Pneumatic nebulization is disabled in neonatal ventilation. If needed, use the Aerogen nebulizer in neonatal ventilation.
- The ventilator generates a continuous and constant base flow from the inspiratory outlet to the expiratory outlet during the later part of exhalation. The base flow is set to a fixed 6 l/min.

Some of the ventilation parameters require special consideration when setting up the ventilator for a neonatal patient.

This section briefly describes the following parameters:

- Weight
- P-ramp
- TI max

For additional information on these and all other parameters, see:

- Table 4-2 (Chapter 4) for definitions of the ventilator control parameters
- Tables A-5 and A-6 for parameter ranges, default settings, and accuracy of measurements applicable to neonatal patients

5.4.1 Weight

For neonates, the ventilator uses actual body weight. Be sure to set the correct patient weight on the Patient setup screen before starting ventilation. See Section 5.2 on page page 106.

Setting the **Weight** parameter correctly is very important in neonatal ventilation, as tidal volume and minute volume alarm limits are set based on patient weight.

By default, neonatal weight is set to 2 kg.

For parameter details, see Table A-5.

5.4.2 TI max

The **TI max** (maximum inspiratory time) parameter is set for spontaneous breaths in NIV, NIV-ST and NCPAP-PS modes.

For all patient groups, the switchover from inspiration to exhalation in spontaneous breaths is normally controlled by the ETS (expiratory trigger sensitivity). If gas leakage is significant, however, the set ETS may never be reached. The **TI max** setting provides a backup so inspiration can be terminated. The ventilator switches over to

exhalation when the set **TI max** is reached.

For parameter details, see Table A-5.

5.4.3 P-ramp

P-ramp is the pressure ramp, which describes the time required to reach target pressure.

Note that **P-ramp** time cannot exceed one-third of the inspiratory time (TI). In addition, adjustment of the TI time can override **P-ramp**.

By default, **P-ramp** is set to 50 ms for neonates. In the following modes, the maximum setting is 200 ms: SPONT, NIV, NIV-ST, nCPAP-PS.

If a neonatal patient has stiff lungs (for example, RDS), be careful when using a short **P-ramp** (pressure rise time). A very short **P-ramp** in this case may cause pressure overshoot.

For parameter details, see Table A-5.

5.5 Alarms for neonatal ventilation

The following adjustable alarms require special consideration for a neonatal patient:

- Volume-related alarms, Vt and ExpMinVol (see Section 5.5.1)

For additional information about alarms and settings, see Tables 8-2 and A-8.

5.5.1 Volume-related alarms, Vt and ExpMinVol

Note that the following adjustable alarms use patient weight to set the initial alarm limits:

- Tidal volume, high and low (VT)
- Minute volume, high and low (ExpMinVol)

Be sure to set the correct patient weight on the Patient setup screen in standby before starting ventilation. See Section 5.2.1.

5.6 O₂ enrichment for neonates

 WARNING

Prolonged exposure to high oxygen concentrations may cause irreversible blindness and pulmonary fibrosis in pre-term neonates.

The applied oxygen concentration during the enrichment maneuver is increased by 25% of the last oxygen setting. For example, if the last oxygen setting = 40%, the resulting oxygen concentration during O₂ enrichment maneuver will be 50%.

For additional details on performing O₂ enrichment, see Chapter 9.

6

Monitoring ventilation

6.1	Overview	120
6.2	Viewing numeric patient data	121
6.3	Viewing graphical patient data	122
6.4	Trends	130
6.5	Loops	131
6.6	Table of monitored parameters	132
6.7	Freeze and cursor measurement	141

6.1 Overview

CAUTION

- To ensure that oxygen monitoring is always fully functional, replace an exhausted or missing oxygen cell as soon as possible or use an external monitor that complies with ISO 80601-2-55.
- The HAMILTON-C3's oxygen monitoring function can be disabled. Ensure that an alternative means of oxygen monitoring is always available and enabled.
- In case of a problem developing with the ventilator's built-in monitoring and in order to maintain an adequate level of patient monitoring at

all times, it is recommended that additional independent monitoring devices be used. The operator of the ventilator must still maintain full responsibility for proper ventilation and patient safety in all situations.

During ventilation, you can view patient data on the HAMILTON-C3 screen (Figure 6-1). You can configure the screen layout with different waveforms, loops or trends, or with Intelligent Panel graphics to suit your institution's needs. Access the Monitoring window at any time without affecting breath delivery.

Figure 6-1 Main display

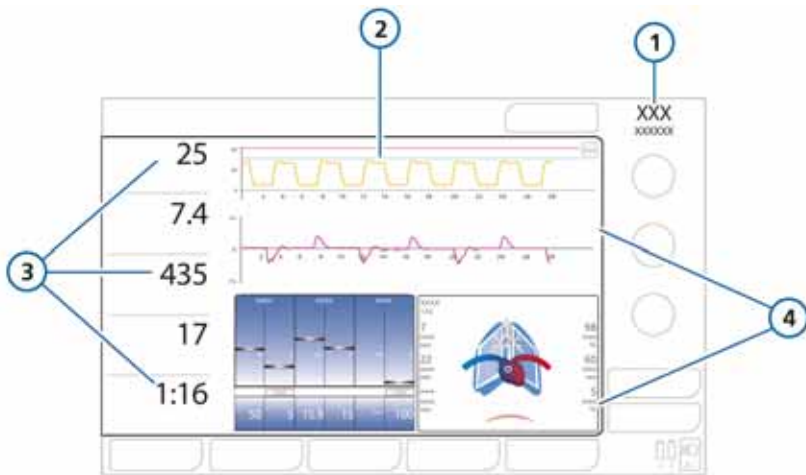

- | | | | |
|---|-----------------------|---|--|
| 1 | Current mode | 3 | Main monitoring parameters (MMP) (Section 6.2.1) |
| 2 | Full-length waveforms | 4 | Graphic display, configurable (Section 6.3.1)
<i>Available options depend on the selected layout.</i> |

6.2 Viewing numeric patient data

Numeric patient data is readily available in the following locations:

- The main display prominently shows the configured main monitoring parameters (MMPs). See Section 6.2.1.
- The Monitoring window provides access to all of the parameter data, including CO₂ values, when enabled. See Section 6.2.2.

6.2.1 About the main monitoring parameters (MMP)

The MMPs are the numerical monitoring parameters shown on the left side of the display. Every displayed parameter has three critical elements: the current value, name, and unit of the monitoring parameter.

The factory default MMPs are peak pressure, expiratory minute volume, tidal volume, total respiratory rate, and I:E. The MMPs that are displayed, as well as their sequence on the display, can be changed in configuration (Section I.5). Note that **Ppeak** is always displayed. Any of the monitored parameters can be displayed as an MMP. As a result, since the display is configurable, MMPs may differ between individual ventilators.

MMPs are normally displayed in white. It may also be shown in yellow or red if it is directly related to an active alarm, such as **Pressure high** or **Tidal volume low**. The color of the MMP corresponds to the alarm priority (Chapter 8). After the alarm resets, the affected MMP returns to white.

Figure 6-2 MMP components

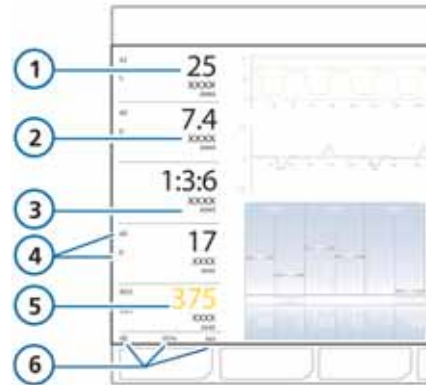

1	MMP value	4	Upper and lower alarm limits
2	Name of parameter	5	Parameter associated with an active alarm
3	Unit of measure	6	SpO ₂ lower alarm limit and current SpO ₂ value (when SpO ₂ enabled)

6.2.2 Viewing patient data in the Monitoring window

The Monitoring window provides access to all of the parameter data, including CO₂ and SPO₂ values, when enabled.

Figure 6-3 shows the monitored parameters in the General Monitoring window. Additional parameters are displayed in the CO₂ and SpO₂ window, when available.

Figure 6-3 General monitoring window

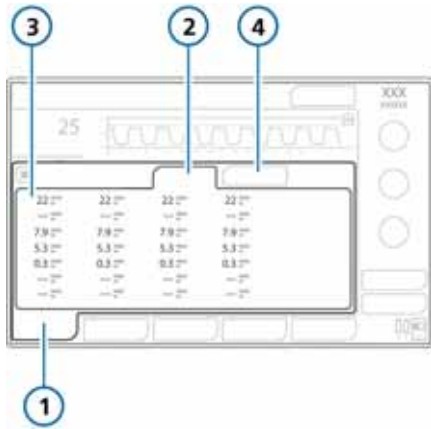

- 1 Monitoring
- 2 General
- 3 Parameter values
- 4 CO2 and SpO2 (if installed and enabled)

To display the Monitoring window

- ▶ Touch the **Monitoring** button.
The Monitoring > General window displays ventilation parameter values.

The **CO2** and **SpO2** tabs, when available, provide access to CO2- and SpO2-related parameter values, respectively.

6.3 Viewing graphical patient data

In addition to numerical data, the ventilator shows user-selectable graphical views of real-time patient data.

The HAMILTON-C3 offers a variety of graphic areas on the display that can show long and short waveforms, as well as graphic panels. Table 6-1 shows the options for each graphic type.

Table 6-1 Graphics options

Graphic type/Tab name	Options
Trends	1-, 6-, 12-, 24-, or 72-h trend data for a selected parameter or combination of parameters
Loops	<ul style="list-style-type: none"> • Pressure/volume • Pressure/flow • Volume/Flow <ul style="list-style-type: none"> • Volume/PCO₂¹ • Volume/FCO₂¹
Graphics (Intelligent panels)	<ul style="list-style-type: none"> • Dynamic Lung² • Vent Status <ul style="list-style-type: none"> • ASV Graph
Waveforms	<ul style="list-style-type: none"> • Pressure • Flow • Volume • Off <ul style="list-style-type: none"> • PCO₂¹ • FCO₂¹ • Plethysmogram³

1. CO2 option required
 2. Adult/pediatric only
 3. SpO2 option required

How the graphics are arranged on the display is also configurable by choosing one of several layouts, described in Table 6-2.

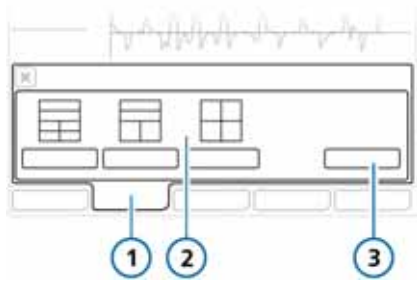

Figure 6-4 Graphics window



- 1 Graphics 3 Defaults
2 Layout 1, 2, 3

The following layouts are available:

Table 6-2 Graphic layout options

	Layout 1. Four full-length waveforms
	Layout 2. Two full-length waveforms and any combination of panels and short waveforms described in Table 6-1
	Layout 3. Any combination of short waveforms and graphic panels described in Table 6-1

Each patient group (adult/pediatric and neonatal) can be set up with a default graphics layout in each of the three available Quick Setups. For details, see Section I.6.1.

When setting up a new patient, the default layout is applied.

You can change the layout and displayed graphics at any time. You can also revert to the default layout.

To change the layout of the graphics

1. Touch the **Graphics** button (Figure 6-4).
2. Touch the desired layout option, **Layout 1, 2, or 3**.

To revert to the default layout specified for the selected Quick Setup, touch **Defaults**.

The window closes automatically, and the display adjusts to the new selection.

To change the contents of a graphics panel

1. Touch the area of the display to configure.

For example, if using Layout 3 and you wish to select or change the graphic for the bottom right panel, touch the bottom right part of the display (Figure 6-5).

The selected panel is highlighted in yellow.

Figure 6-5 Select area for graphic

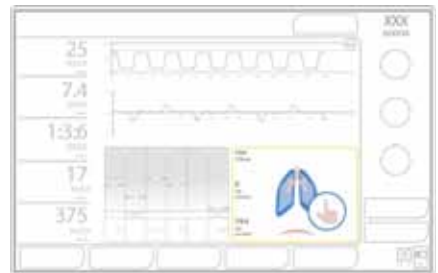

The graphics selection window appears (Figure 6-6), displaying the current selection and other available options for the selected area. Table 6-2 describes which options are available in each area of the display.

The window also shows a thumbnail of the selected layout, with the area you are changing highlighted in yellow.

Figure 6-6 Graphics selection window

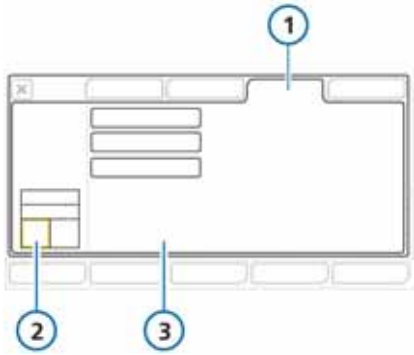

- 1 Trends, Loops, Graphics, Waveforms
- 2 Selected layout, highlighting the active display area
- 3 Available options for each view

2. Touch the desired option to select it, or touch a tab (**Trends, Loops, Graphics, Waveforms**) to access additional options. Table 6-1 lists the options on each tab.

After making a selection, the window closes automatically, and the display adjusts to the new selection.

6.3.1 About graphic types

The following sections describe the different graphical display options in more detail.

Table 6-3 Graphic types

	See
Waveforms	Section 6.3.2
Trends	Section 6.4.1
Loops	Section 6.5.1
Intelligent panels (Dynamic Lung, Vent Status, ASV Graph)	Chapter 7

For details on accessing the graphics selection window, see Section 6.3.

6.3.2 Waveforms

The ventilator can plot pressure, volume, and flow against time, in addition to CO₂- and SpO₂-related data (if installed).

By default the pressure/time graph is displayed at the top of the screen, but you can choose any other waveform as well. For details, see Section 6.3.2.3.

Figure 6-7 Waveform display

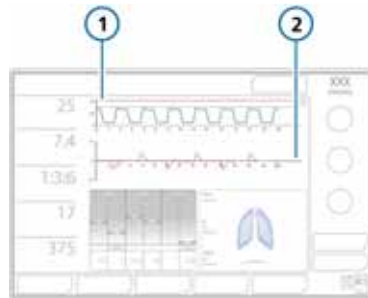

- 1 Pressure/time waveform
- 2 Flow/time waveform

On the pressure/time waveform, a blue pressure limitation line shows the maximum applied pressure, which is 10 cmH₂O below the set high Pressure alarm limit. The Pressure limit is shown as a red line.

Figure 6-8 Pressure/time graph

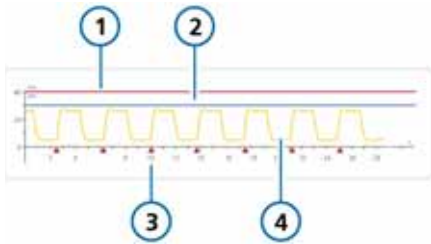

- | | |
|---|----------------------------------|
| 1 Pressure high alarm limit | 3 Patient trigger indicator |
| 2 Pressure limitation: <i>Pressure high alarm limit – 10 cmH₂O</i> | 4 Airway pressure (Paw) waveform |

When the ventilator is in the APVcmv/(S)CMV+, or APVsimv/SIMV+ mode, it uses the Pressure limit as a safety boundary for its inspiratory pressure adjustment. The ventilator does not apply inspiratory pressures higher than this pressure limitation value. An exception is sigh breaths, when the ventilator may apply inspiratory pressures 3 cmH₂O below the Pressure alarm limit.

6.3.2.1 Adjusting the scale of a waveform

NOTICE

Changing the scale of **one** waveform affects **all** waveforms displayed in the current layout.

Scale refers to the displayed values of the time axis of a waveform.

The x-axis represents time, while the y-axis can represent a variety of parameters such as tidal volume, pressure, flow and so on. You can change the scale of any waveform, however, this is limited by the graphics layout you use.

A scale value refers to the length of the x-axis. For example, a scale value of 14 means that the x-axis displays the waveform from 0 to 14 seconds.

If you change the layout, the waveform will automatically change to the next higher or lower scale value depending on the layout you change to. For example, a scale value of 28 s in a full-length waveform will change to 21 s when you change to a small-format waveform.

The HAMILTON-C3 offers the following scaling options, in seconds:

- Full-length waveforms: 7, 14, 21, 28, 56
- Short-format waveforms: 3.5, 7, 14, 21, 28, 56

For details on waveform layout options, see Section 6.3.2.2.

Figure 6-9 Waveforms window

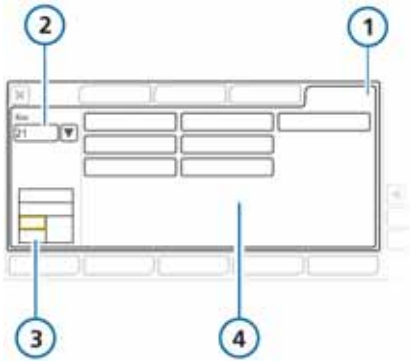

- | | |
|------------------------|---|
| 1 Waveforms | 3 Selected layout, highlighting the active display area |
| 2 Time scale selection | 4 Waveform options selection |

To change the scale

1. Touch the waveform to adjust.
The Waveforms window opens.
2. Touch the arrow button.
A drop-down menu with the selectable entries appears.
3. Turn the P&T knob to select the desired scale value and then press the knob to confirm the selection.
The name of the time scale button changes to match your selection.
4. Select the value to plot against time.
Once the selection is made, the window closes and the selected waveform is displayed.

6.3.2.2 Waveform layout options

You can show one or more waveforms on the display, depending on which layout option you select (Table 6-2).

Table 6-4 Waveform layout options

Layout 1. Up to four full-length waveforms

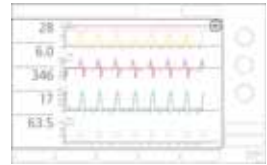

Layouts 2 and 3. Up to two full-length and two or more small-format waveforms

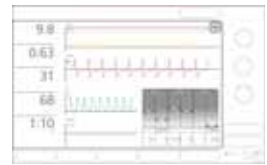

6.3.2.3 Displaying additional waveforms

As described in Table 6-4, you can either select sets of one or two short-format waveforms or additional full length waveforms (page page 128).

To display additional short-format waveforms

1. Touch the area of the display where you wish to show a waveform. See Table 6-4 for details about available layouts and waveforms.

For example, to select short-format waveforms at the bottom right of the display, touch the area at the bottom right.

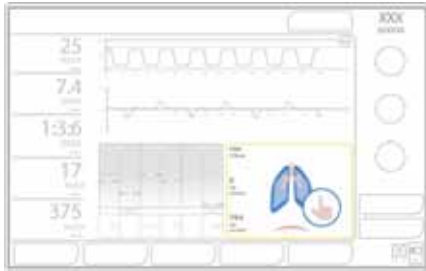

In the example above, because you are touching the Dynamic Lung, which is a graphic panel, the graphics selection window opens with the **Graphics** tab selected.

2. In the graphics selection window, touch the **Waveforms** tab.

The selections available for the highlighted display area are shown in the window.

When changing from a graphic panel to a waveform, by default, the top waveform area is selected first.

Figure 6-10 Waveforms window, top short waveform area selected

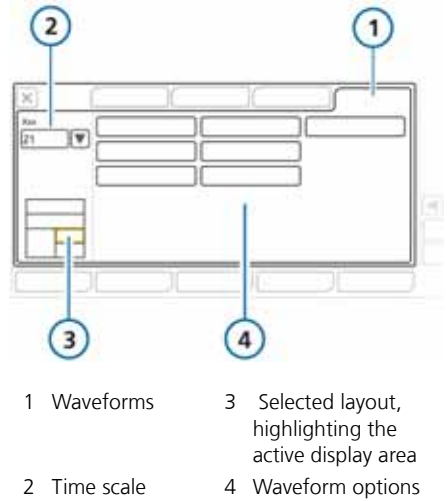

3. Select the time scale to use.
4. Select the value to plot against time.
Once the selection is made, the window closes and the selected waveform is displayed.

- To define the second waveform, touch the area of the display under the waveform you just added.



- Waveform just added
- Touch area under waveform to select another one

The graphics selection window appears, with the **Waveforms** tab selected, and the bottom half of the display area selected.

Figure 6-11 Waveforms window, bottom short waveform area selected

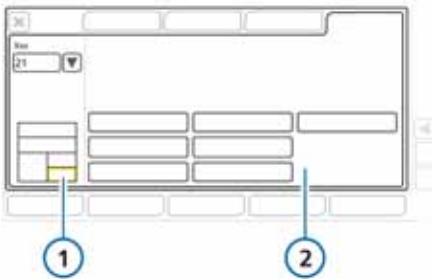

- Select the time scale to use.
- Select the value to plot against time.
To leave an area blank, select **Off**.

Once the selection is made, the window closes and the selected waveform is displayed. The lower right corner now shows the two short-format waveforms you selected.

Figure 6-12 Two short-format waveforms displayed

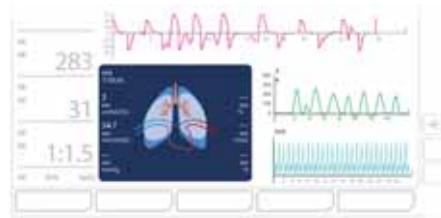

To select additional long-format waveforms

- Touch the area of the display where you wish to show a full length waveform. See Table 6-4 for details about available layouts and waveforms.

For example, to show a third full-length waveform, be sure Layout 1 is selected and touch the display as shown below.



- Selected layout, highlighting the active display area
- Waveform options

The graphics selection window appears, with the **Waveforms** tab selected.

Figure 6-13 Waveforms window, full-length waveform selection

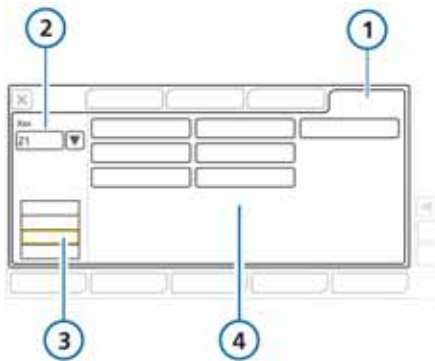

- | | |
|------------------------|---|
| 1 Waveforms | 3 Selected layout, highlighting the active display area |
| 2 Time scale selection | 4 Waveform option |

2. Select the time scale to use.
3. Select the value to plot against time.
To leave an area blank, select **Off**.
Once the selection is made, the window closes and the selected waveform is displayed.
4. To add a fourth waveform, touch the empty area of the display, and repeat steps 2 and 3.

Figure 6-14 Full-length waveforms

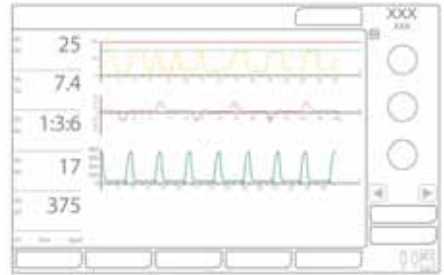

6.3.3 Dynamic Lung

The Dynamic Lung panel visualizes tidal volume, lung compliance, patient triggering, and resistance in real-time.

For details about the panel and how to display it, see Chapter 7.

6.3.4 Vent Status

The Vent Status panel visualizes parameters related to oxygenation, CO₂ elimination, and patient activity, and indicates the patient's level of ventilator dependence and when discontinuing ventilation should be considered.

For details about the panel and how to display it, see Chapter 7.

6.3.5 ASV Graph

Available in ASV mode, the ASV graph shows how the adaptive lung controller moves toward its targets. The graph shows both the target and real-time patient data for tidal volume, frequency, pressure, and minute ventilation.

For details about the panel and how to display it, see Chapter 7 and Appendix C.

6.4 Trends

You can view monitored parameters as 1-, 6-, 12-, 24-, or 72-h trends. Trend data includes all data for the selected parameter since you switched on the ventilator for the past 1, 6, 12, 24, or 72 hours.

Figure 6-15 Trend display

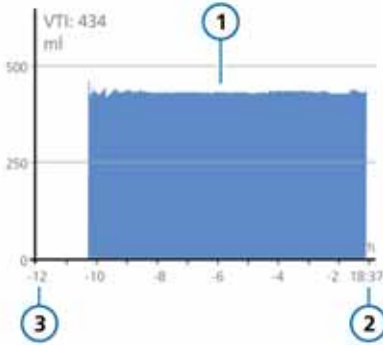

- | | |
|----------------|------------------------------------|
| 1 Trend graph | 3 Elapsed time relative to present |
| 2 Current time | |

From the time you turn on the HAMILTON-C3, the ventilator continually stores up to 72 hours of monitored parameters in its memory, so you have access to any of this data, even after standby. If the HAMILTON-C3 is turned off, the data of the last patient is available in memory when ventilator is turned on again.

The freeze and cursor measurement function (Section 6.7) can also be used to examine points on trend waveforms. When trends are frozen, the time axis shows elapsed time relative to the present and the corresponding value of the monitored parameter.

All monitoring parameters can be trended. The following parameters are trended in combination:

- Ppeak/PEEP
- fTotal/fControl
- MVSPONT/Exp-MinVol
- Vtalv/VTE

6.4.1 Displaying trends

Trend graphs can be displayed using graphic layouts 2 and 3 (Table 6-2).

Figure 6-16 Trends tab

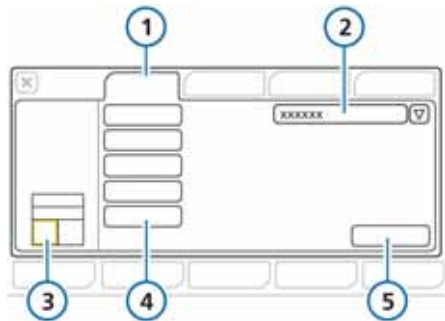

- | | |
|---|------------------------|
| 1 Trends | 4 Trend time, in hours |
| 2 Parameter list | 5 Confirm button |
| 3 Selected layout, highlighting the selected display area | |

To display trends

1. Touch the area of the display where you wish to show a trend graph.
For example, to show a trend graph in the bottom left graphics panel, touch that area of the display.

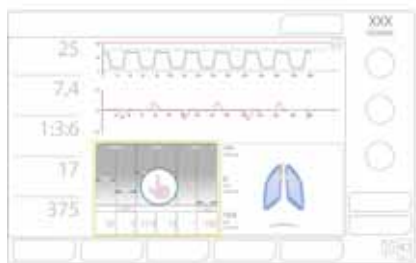

2. In the graphics selection window, touch the **Trends** tab (Figure 6-16).
3. Select the parameter(s) to trend:
 - a. Touch the arrow next to the Parameter list, and turn the P&T knob to scroll through the list.
 - b. Press the knob to select an entry.
4. Select the desired trend time button.
5. Touch the **Confirm** button.

The selected trend information is displayed (Figure 6-15).

6.5 Loops

The HAMILTON-C3 can display a dynamic loop based on the following parameter combinations, depending on the options installed.

- Pressure/volume
- Pressure/flow
- Volume/Flow
- Volume/FCO2
- Volume/PCO2

Figure 6-17 Loop display

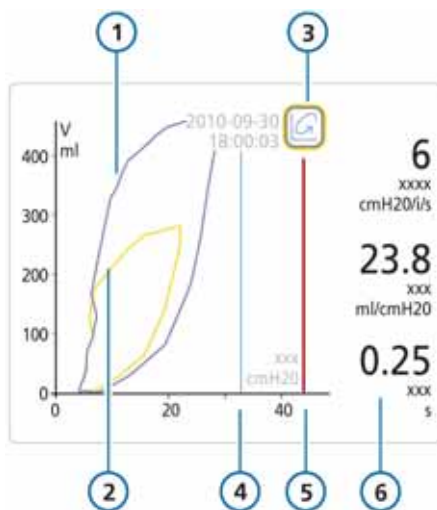

- | | |
|---------------------------------|--|
| 1 Curve in the past (reference) | 4 Pressure high alarm limit |
| 2 Current curve | 5 Pressure limitation: <i>Pressure high alarm limit – 10 cmH2O</i> |
| 3 Loop reference button | 6 Key parameters: Rinsp, Cstat, RCexp |

6.5.1 Displaying loops

Loops can be displayed in layouts 2 and 3. See Table 6-2.

Figure 6-18 Loops tab

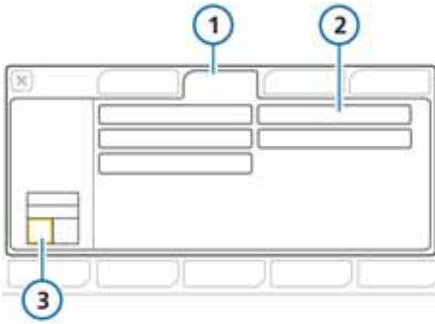

- | | |
|---|--|
| <p>1 Loops</p> <p>2 Parameter combination options</p> | <p>3 Selected layout, highlighting the selected display area</p> |
|---|--|

To display loops

1. Touch the area of the display where you wish to show a loop. See Section 6.3.
2. In the graphics selection window, touch the **Loops** tab.
3. Touch the button for the parameter combination to display.

The selected combination is displayed (Figure 6-17).

6.5.2 Storing loops

To store a new loop

In the Loop display (Figure 6-17), touch the **Loop reference** button (Figure 6-17) to store the loop curve with the current date and time. The past and current characteristics are shown.

If the parameter combination is changed and the **Loop reference** button is pressed again, the present curve is stored. The one before is lost.

6.6 Table of monitored parameters

NOTICE

- The HAMILTON-C3 automatically calculates inspiratory resistance (R_{insp}), compliance (C_{stat}), and AutoPEEP breath by breath, during mandatory and spontaneous breaths in all modes, without interruption in ventilation.
- Actively breathing patients can create artifacts or noise, which can affect the accuracy of these measurements, however. The more active the patient, the less accurate the measurements.

Table 6-5 is an alphabetical list of the HAMILTON-C3's monitored parameters. These parameters are displayed in the Monitoring window (Figure 6-3). The display of monitored parameters is updated every breath.

Table A-6 in Appendix A provides the parameter ranges and accuracy.

Table 6-5 Monitored parameters

Parameter (unit)	Definition
<i>For parameter ranges and accuracy, see Table A-6 on page 219.</i>	
AutoPEEP (cmH ₂ O)	<p>The difference between the set PEEP and the calculated total PEEP within the lungs. AutoPEEP is the abnormal pressure generated by air “trapped” in the alveoli due to inadequate lung emptying. Ideally, it should be zero. AutoPEEP is calculated using the LSF method applied to the entire breath.</p> <p>When AutoPEEP is present, volutrauma or barotrauma might develop. In active patients, AutoPEEP may present an extra workload to the patient.</p> <p>AutoPEEP or air trapping may result from an expiratory phase that is too short, which may be observed under these conditions:</p> <ul style="list-style-type: none"> • Delivered tidal volume too large • Expiratory time too short or respiratory rate too high • Circuit impedance too high or expiratory airway obstruction • Peak expiratory flow too low
Cstat (ml/cmH ₂ O)	<p>Static compliance of the respiratory system, including lung and chest wall compliances. It is calculated using the LSF method. Cstat can help diagnose changes in elastic characteristics of the patient's lungs. Also displayed in the Dynamic Lung panel.</p>
<div style="background-color: #0070C0; color: white; padding: 2px 10px; display: inline-block;">NOTICE</div>	
<p>Actively breathing patients can create artifacts or noise, which can affect the accuracy of these measurements.</p>	
Exp Flow (l/min)	Peak expiratory flow.
ExpMinVol (l/min) MinVol NIV	Expiratory minute volume. The moving average of the monitored expiratory volume per minute over the last 8 breaths. ExpMinVol changes to MinVol NIV in noninvasive modes. MinVol NIV is an adjusted parameter taking into account the leakage.
fControl (b/min)	Mandatory breath frequency. The moving average of machine-delivered breaths per minute over the last 8 total breaths.

Table 6-5 Monitored parameters (continued)

Parameter (unit)	Definition
<i>For parameter ranges and accuracy, see Table A-6 on page 219.</i>	
FetCO ₂ (%)	Fractional end-tidal CO ₂ concentration. PetCO₂/(Pambient – PH₂O) where P _{H₂O} = 47 mmHg Permits assessment of arterial CO ₂ . Note that it is inaccurate in pulmonary embolism. Available when an optional CO ₂ sensor is connected and enabled.
fSpont (b/min)	Spontaneous breath frequency. The moving average of spontaneous breaths per minute over the last 8 total breaths. An increased fSpont may indicate that the patient is compensating for a low compliance. This may indicate ventilatory fatigue due to imposed work of breathing.
fTotal (b/min)	Total breathing frequency. The moving average of the patient's total breathing frequency over the last 8 breaths, including both mandatory and spontaneous breaths. When the patient triggers or the user initiates a breath, fTotal may be higher than the Rate setting.
NOTICE	
Respiratory rate monitoring on the HAMILTON-C3 requires breath delivery followed by detection of expiratory flow at the proximal flow sensor.	
I:E	Inspiratory:expiratory ratio. Ratio of the patient's inspiratory time to expiratory time for every breath cycle. This includes both mandatory and spontaneous breaths. I:E may differ from the set I:E ratio if the patient breathes spontaneously.
Insp Flow (l/min)	Peak inspiratory flow, spontaneous or mandatory, measured every breath.
MVSpont/ MVSpont NIV (l/min)	Spontaneous expiratory minute volume. The moving average of the monitored expiratory volume per minute for spontaneous breaths, over the last 8 mandatory and spontaneous breaths. In noninvasive ventilation modes, MVSpont is replaced by MVSpont NIV. MV Spont NIV is an adjusted parameter taking into account the leakage.

Table 6-5 Monitored parameters (continued)

Parameter (unit)	Definition
<i>For parameter ranges and accuracy, see Table A-6 on page 219.</i>	
Oxygen (%)	<p>Oxygen concentration of the delivered gas. It is measured by the oxygen cell in the inspiratory pneumatics.</p> <p>This parameter is not displayed if the oxygen cell is not installed, is defective, or is not a genuine Hamilton Medical part, or if oxygen monitoring is disabled.</p>
P0.1 (cmH2O)	<p>NOTICE</p> <p>Due to changes in pneumatic impedance, P0.1 values may vary with different settings of the Trigger function.</p> <hr/> <p>Airway occlusion pressure. The pressure drop during the first 100 ms when a breath is triggered. P0.1 indicates the patient's respiratory drive and patient inspiration effort.</p> <p>P0.1 applies only to patient-triggered breaths.</p> <p>A P0.1 value of -3 cmH2O indicates a strong inspiratory effort, and a value of -5 cmH2O, an excessive effort, possibly because the patient is "air hungry" (peak inspiratory flow or total ventilatory support is inadequate) or has an excessive drive.</p> <p>If P0.1 is below -3 cmH2O:</p> <ul style="list-style-type: none"> • Increase pressure or volume settings (depending on mode) • Increase %MinVol if in manual mode • Shorten P-ramp time
PEEP/CPAP (cmH2O)	<p>Monitored PEEP (positive end expiratory pressure)/CPAP (continuous positive airway pressure). The airway pressure at the end of exhalation.</p> <p>Measured PEEP/CPAP may differ slightly from set PEEP/CPAP, especially in actively breathing patients.</p>

Table 6-5 Monitored parameters (continued)

Parameter (unit)	Definition
<i>For parameter ranges and accuracy, see Table A-6 on page 219.</i>	
PetCO ₂ (mmHg)	<p>End-tidal CO₂ pressure. The maximum partial pressure of CO₂ exhaled during a tidal breath (just before the start of inspiration). It represents the final portion of air that was involved in the exchange of gases in the alveolar area. Under certain conditions, it thus represents a reliable index of CO₂ partial pressure in the arterial blood.</p>
<p>NOTICE</p> <p>PetCO₂ does not reflect PACO₂ in the case of a pulmonary embolism.</p>	
<p>Available when an optional CO₂ sensor is connected and enabled.</p>	
Pinsp (cmH ₂ O)	<p>Inspiratory pressure, the automatically calculated target pressure (additional to PEEP/CPAP) applied during the inspiratory phase. Available in the Vent Status panel.</p> <p>Pinsp is shown in the following values, depending on the mode:</p> <ul style="list-style-type: none"> • APVcmv, APVsimv: Automatically calculated target pressure • PCV+: Pcontrol setting • PSIMV+, NIV-ST, nCPAP-PS: Pinsp setting • SPONT, NIV: Psupport setting • APRV, DuoPAP: Phigh setting
Pmean (cmH ₂ O)	<p>Mean airway pressure. The absolute pressure, averaged over the breath cycle.</p> <p>Pmean is an important indicator of the possible impact of applied positive pressure on hemodynamics and surrounding organs.</p>
Ppeak (cmH ₂ O)	<p>Peak airway pressure. The highest pressure during the previous breath cycle. It is influenced by airway resistance and compliance. Ppeak may differ noticeably from alveolar pressure if airway flow is high. This value is always displayed.</p>
Pplateau (cmH ₂ O)	<p>Plateau or end-inspiratory pressure. The pressure measured at the end of inspiration when flow is at or close to zero. Used as a rough representation of alveolar pressure.</p> <p>Pplateau is displayed for mandatory and time-cycled breaths.</p>

Table 6-5 Monitored parameters (continued)

Parameter (unit)	Definition										
<i>For parameter ranges and accuracy, see Table A-6 on page 219.</i>											
PTP (cmH ₂ O*s)	<p>Inspiratory pressure time product. The measured pressure drop required to trigger the breath multiplied by the time interval until the PEEP/CPAP level is reached at the beginning of inspiration. The PTP indicates work by the patient to trigger the breath. The work depends on:</p> <ul style="list-style-type: none"> • The intensity of the patient's effort • The trigger sensitivity • The volume and resistance of the breathing circuit <p>PTP does not indicate total patient work but is a good indicator of how well the ventilator is adapted to the patient. PTP is valid for patient-initiated breaths only. If PTP values increase, do the following:</p> <ul style="list-style-type: none"> • Check and remove water in tubes • Increase trigger sensitivity • Decrease Pramp 										
RCexp (s)	<p>Expiratory time constant. The rate at which the lungs empty, as follows:</p> <table border="1"> <thead> <tr> <th><i>Actual TE</i></th> <th><i>% emptying</i></th> </tr> </thead> <tbody> <tr> <td>1 x RCexp</td> <td>63%</td> </tr> <tr> <td>2 x RCexp</td> <td>86.5%</td> </tr> <tr> <td>3 x RCexp</td> <td>95%</td> </tr> <tr> <td>4 x RCexp</td> <td>98%</td> </tr> </tbody> </table> <p>RCexp is calculated as the ratio between VTE and flow at 75% of the VTE.</p> <p>In adults, an RCexp value above 1.2 s indicates airway obstruction, and a value below 0.5 s indicates a severe restrictive disease. Use RCexp to set optimal TE (Goal: TE ≥ 3 x RCexp):</p> <ul style="list-style-type: none"> • In passive patients: Adjust rate and I:E • In active patients: Increase P_{support} and/or ETS to achieve a longer TE <p>These actions may reduce the incidence of AutoPEEP.</p>	<i>Actual TE</i>	<i>% emptying</i>	1 x RCexp	63%	2 x RCexp	86.5%	3 x RCexp	95%	4 x RCexp	98%
<i>Actual TE</i>	<i>% emptying</i>										
1 x RCexp	63%										
2 x RCexp	86.5%										
3 x RCexp	95%										
4 x RCexp	98%										

Table 6-5 Monitored parameters (continued)

Parameter (unit)	Definition
<i>For parameter ranges and accuracy, see Table A-6 on page 219.</i>	
R _{insp} (cmH ₂ O/(l/s))	Resistance to inspiratory flow caused by the endotracheal tube and the patient's airways, during inspiration. It is calculated using the LSF method applied to the inspiratory phase. Also displayed in the Dynamic Lung panel.
<div style="background-color: #0070c0; color: white; padding: 2px 10px; display: inline-block;">NOTICE</div>	
<p>Actively breathing patients can create artefacts or noise, which can affect the accuracy of these measurements.</p>	
slopeCO ₂ (%CO ₂ /l)	Slope of the alveolar plateau in the PetCO ₂ curve, indicating the volume/flow status of the lungs. Permits assessment of chronic hypercapnia, asthma, and inefficient ventilation. Available when an optional CO ₂ mainstream sensor is connected and enabled.
TE (s)	Expiratory time. In mandatory breaths, TE is measured from the start of exhalation until the set time has elapsed for the switchover to inspiration. In spontaneous breaths, TE is measured from the start of exhalation, as dictated by the ETS setting, until the patient triggers the next inspiration. TE may differ from the set expiratory time if the patient breathes spontaneously.
TI (s)	Inspiratory time. In mandatory breaths, TI is measured from the start of breath delivery until the set time has elapsed for the switchover to exhalation. In spontaneous breaths, TI is measured from the patient trigger until the flow falls to the ETS setting, for the switchover to exhalation. TI may differ from the set inspiratory time if the patient breathes spontaneously.
V' _{alv} (ml/min)	Alveolar minute ventilation. Permits assessment of actual alveolar ventilation (as opposed to minute ventilation). Valv * f (normalized to 1 min) Available when an optional CO ₂ mainstream sensor is connected and enabled.

Table 6-5 Monitored parameters (continued)

Parameter (unit)	Definition
<i>For parameter ranges and accuracy, see Table A-6 on page 219.</i>	
V'CO ₂ (ml/min)	CO ₂ elimination. Net exhaled volume of CO ₂ per minute. Permits assessment of metabolic rate (for example, it is high with sepsis, tetanus, etc.) and treatment progress. Available when an optional CO ₂ mainstream sensor is connected and enabled.
VDaw (ml)	Airway dead space. Gives an effective, in-vivo measure of volume lost in the conducting airways. A relative increase in dead space points to a rise in respiratory insufficiency and can be regarded as an indicator of the current patient situation. Patients with high dead space values are at particular risk if the muscles also show signs of fatigue. Available when an optional CO ₂ mainstream sensor is connected and enabled.
VDaw/VTE (%)	Airway dead space fraction at the airway opening. Available when an optional CO ₂ mainstream sensor is connected and enabled.
VeCO ₂ (ml)	Exhaled CO ₂ volume. Updated breath by breath. Available when an optional CO ₂ mainstream sensor is connected and enabled.
ViCO ₂ (ml)	Inspired CO ₂ volume. Updated breath by breath. Available if optional CO ₂ mainstream sensor is installed.
Vtalv (ml)	Alveolar tidal ventilation. VTE - VDaw Available if optional CO ₂ mainstream sensor is installed.
VLeak (%)/ MVLeak (l/min)	Due to the leakage at the patient interface, displayed exhaled volumes in the noninvasive modes can be substantially smaller than the delivered volumes. The flow sensor measures the delivered volume and the exhaled tidal volume; the ventilator displays the difference as VLeak in %, and as MVLeak in l/min, averaged over the past 8 breaths. VLeak/MVLeak can indicate leaks on the patient side of the flow sensor (endotracheal tube, chest tube, mask). They do not include leakage between the ventilator and flow sensor. Use VLeak and MVLeak to assess the fit of the mask or other noninvasive patient interface.

Table 6-5 Monitored parameters (continued)

Parameter (unit)	Definition
<i>For parameter ranges and accuracy, see Table A-6 on page 219.</i>	
VTE/VTE NIV (ml)	<p>Expiratory tidal volume. The volume exhaled by the patient. It is determined from the flow sensor measurement, so it does not show any volume added due to compression or lost due to leaks in the breathing circuit.</p> <p>If there is a gas leak at the patient end, the displayed VTE may be less than the tidal volume the patient actually receives.</p> <p>In noninvasive ventilation modes, VTE is replaced by VTE NIV. VTE NIV is an adjusted parameter taking into account the leakage.</p>
VTEspont (ml)	<p>Spontaneous expiratory tidal volume. The volume exhaled by the patient.</p> <p>If there is a gas leak at the patient end, the displayed VTEspont may be less than the tidal volume the patient actually receives.</p> <p>Only displayed for spontaneous breaths.</p>
VTI (ml)	<p>Inspiratory tidal volume. The volume delivered to the patient, determined from the flow sensor measurement.</p> <p>If there is a gas leak at the patient end, the displayed VTI may be larger than the displayed VTE.</p>
Vt/IBW and Vt/Weight (kg)	<p>Tidal volume is calculated according to ideal body weight (IBW) for adult/pediatric patients and according to actual patient weight for neonatal patients.</p>

6.7 Freeze and cursor measurement

This function lets you freeze the display of waveforms, loops and trends for up to 30 seconds.

When enabled, all of the displayed waveforms are frozen, allowing you to scroll through them for a detailed review. The freeze function is time-synced across all of the displayed waveforms, regardless of each waveform's selected time scale.

The freeze function is particularly useful when you perform a breath hold maneuver. The display automatically freezes following a successful inspiratory maneuver.

To freeze the graphic

1. Touch the **Freeze** button  at the right upper corner of the display.
All of the displayed waveforms are frozen for 30 seconds.
2. To scroll through the waveforms for analysis, turn the Press-and-turn knob clockwise or counter-clockwise.
The waveform displays move to the left and to the right. The cursor is shown at the same time point across all of the waveforms.
3. Unfreeze the display and return to displaying real-time waveforms by pressing the **Freeze** button again or by pressing the Press-and-turn knob.

7

Intelligent panels

7.1	Overview	144
7.2	Dynamic Lung panel	144
7.3	Vent Status panel	146
7.4	ASV Graph panel	148

7.1 Overview

You can lay out the ventilator screen to display any of the three types of Intelligent Panel:

- Dynamic Lung
- Vent Status (Section 7.3)
- ASV Graph (Section 7.4)

7.2 Dynamic Lung panel

NOTICE



The Dynamic Lung panel is not available for neonates.

The Dynamic Lung panel visualizes tidal volume, lung compliance, patient triggering, and resistance in real-time. The lungs expand and contract in synchrony with actual breaths.

When the SpO2 option is enabled, the Dynamic Lung panel is expanded to show the circulation of blood through the heart, superimposed on the breathing of the lungs. For details, see the *Pulse oximetry Instructions for use* for the HAMILTON-C3.

Numeric values for resistance (R_{insp}) and compliance (C_{stat}) are displayed. In addition, the shape of the lungs and the bronchial tree are also related to the compliance and resistance values. If all values are in a normal range, the panel is framed in green.

The following sections describe each of the panel components in more detail.

Figure 7-1 Dynamic Lung panel

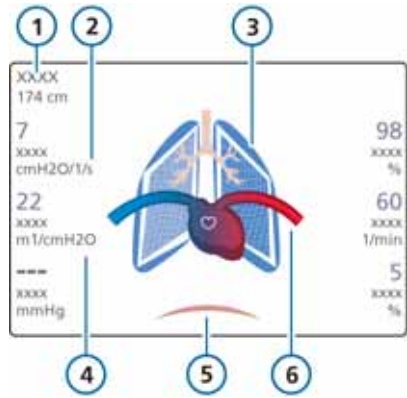

- | | |
|---|--|
| 1 Gender and height | 4 Compliance of the lung, Cstat (Section 7.2.3) |
| 2 Resistance of the lung, R _{insp} (Section 7.2.5) | 5 Patient trigger (diaphragm) |
| 3 "Normal" lungs (reference) | 6 Heart and pulse display (when SpO2 sensor enabled and connected) |

7.2.1 Displaying the Dynamic Lung

The Dynamic Lung panel can be displayed in layouts 2 and 3. See Table 6-2.

To display the Dynamic Lung

1. Touch the area of the display where you wish to show the Dynamic Lung panel. See Section 6.3.
2. In the graphics selection window, touch the **Graphics** tab.

Figure 7-2 Graphics tab, Dynamic Lung

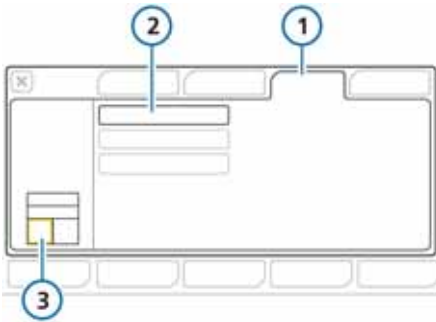

- 1 Graphics
- 2 Dynamic Lung
- 3 Selected layout, highlighting the selected display area

3. Touch the **Dynamic Lung** button.
The Dynamic Lung is displayed (Figure 7-1).

7.2.2 Tidal volume (Vt)

The Dynamic Lung expands and contracts to show tidal volume (Vt) in real-time. It moves in synchrony with actual breaths, based on the proximal flow sensor signal. The lung size displayed is relative to “normal” size for the patient’s height (IBW), based on a “normal” value of 10 ml/kg. A *disconnection* alarm is indicated by a deflated lung. An *Exhalation obstructed* alarm is indicated by an inflated lung.

7.2.3 Compliance (Cstat)

The Dynamic Lung shows compliance (Cstat) breath by breath relative to “normal” values for the patient’s height. As the figure shows, the shape of the lungs changes with compliance. The numeric value is also displayed. The lung in the middle shows “normal” compliance.

Figure 7-3 Compliance shown by the Dynamic Lung



- 1 Low compliance
- 2 Normal compliance
- 3 High compliance

7.2.4 Patient triggering: Muscle

The muscle in the Dynamic Lung shows patient triggering.

Figure 7-4 Patient triggering shown by the Dynamic Lung muscle



7.2.5 Resistance (R_{insp}): Bronchial tree

The bronchial tree in the Dynamic Lung shows resistance (R_{insp}) breath by breath relative to “normal” values for the patient’s height. The numeric value is also displayed. The gray portion of the image shows the relative degree of resistance: the leftmost tree shows “normal” resistance.

Figure 7-5 R_{insp} shown by the bronchial tree of the Dynamic Lung

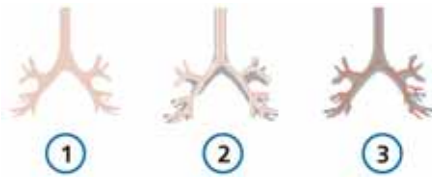

- 1 Normal resistance
- 2 Moderately high resistance
- 3 High resistance

Figure 7-6 Dynamic Lung normal values

Parameter	Definition of normal value
Tidal volume (V _t)	10 ml/kg IBW (calculated from Pat. height)
Compliance (C _{stat})	For Pat. height between 30 and 135 cm (11 and 53 in): $0.000395 * Pat. height^{2.38}$ For Pat. height > 135 cm (53 in): $-0.0028 * Pat. height^2 + 1.3493 * Pat. height - 84.268$

Figure 7-6 Dynamic Lung normal values

Parameter	Definition of normal value
Resistance (R _{insp})	For Pat. height ≤ 210 cm (83 in): $(1.993 - 0.0092 * Pat. height) * 10.2 + 5$ For Pat. height > 210 cm (83 in): 5.5

7.3 Vent Status panel

The Vent Status panel (Figure 7-7) displays six parameters related to the patient’s ventilator dependence, including oxygenation, CO₂ elimination, and patient activity. A floating indicator (floater) moving up and down within the column shows the value for a given parameter. When the indicator is in the light blue (weaning) zone, a timer starts, showing how long that value has been in the weaning zone. When all values are in the weaning zone, the Vent Status panel is framed in green, indicating that weaning should be considered. The panel is updated breath by breath.

Table 7-8 describes the parameters shown in the Vent Status panel. You can configure the weaning zone ranges in configuration. To set these values, see Section I.6.1, step 9. For parameter ranges and details, see the tables in Appendix A.

Figure 7-7 Vent Status panel

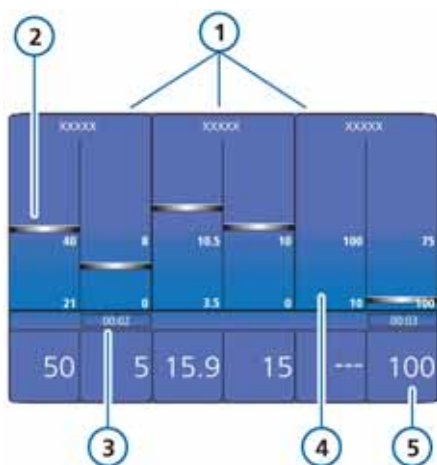

- | | | | |
|---|---|---|---|
| 1 | Group title | 4 | Light blue weaning zone with user-configurable limits |
| 2 | Monitored value, graphic (floater) | 5 | Monitored value, numeric |
| 3 | Elapsed time value has been in weaning zone | | |

Figure 7-8 Vent Status parameters

Parameter (unit)	Definition
<i>For additional details, including ranges and accuracy, see Table A-5 on page 213.</i>	
Oxygen (%)	Oxygen setting.
PEEP (cmH ₂ O)	PEEP/CPAP setting.
MinVol (l/min)	Normal minute ventilation (defined in Appendix C).

Figure 7-8 Vent Status parameters

Parameter (unit)	Definition
<i>For additional details, including ranges and accuracy, see Table A-5 on page 213.</i>	
Pinsp (cmH ₂ O)	Inspiratory pressure, the target pressure (additional to PEEP/CPAP) applied during the inspiratory phase.
RSB (1/(l*min)) ^a	<p>Rapid shallow breathing index. The total breathing frequency (f_{Total}) divided by the exhaled tidal volume (VTE).</p> <p>Because a patient with dyspnea typically takes faster, shallower breaths than a non-dyspnoeic patient, RSB is high in the dyspnoeic patient and low in the non-dyspnoeic patient.</p> <p>RSB is often used clinically as an indicator to judge whether a ventilated patient is ready for weaning.</p> <p>RSB has significance for spontaneously breathing patients only and is shown only if 80% of the last 25 breaths are spontaneous.</p>
%fSpont (%)	Spontaneous breath percentage. The moving average of the percentage of spontaneous breaths over the last 8 total breaths.

a. Weaning zone defaults are based on a normal of <100/(l*min) for adult patients.

7.3.1 Displaying the Vent Status panel

The Vent Status panel can be displayed in layouts 2 and 3. See Table 6-2.

Figure 7-9 Graphics tab, Vent Status

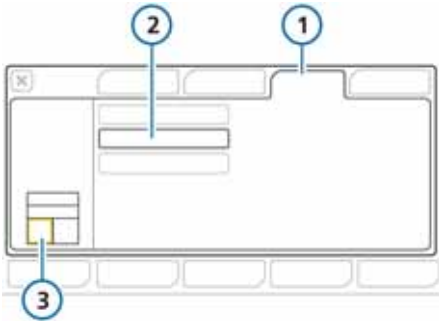

- 1 Graphics
- 2 Vent Status
- 3 Selected layout, highlighting the selected display area

To display the Vent Status panel

1. Touch the area of the display where you wish to show the Vent Status panel. See Section 6.3.
2. In the graphics selection window, touch the **Graphics** tab.
3. Touch the **Vent Status** button.

The Vent Status panel is displayed (Figure 7-7).

7.4 ASV Graph panel

Available in ASV mode, the ASV Graph shows how the adaptive lung controller moves toward its targets. The graph shows both the target and real-time patient data for tidal volume, frequency, pressure, and minute ventilation.

For details about the graph, see Figure C-3 in Appendix C.

Figure 7-10 ASV target graphics window (1)

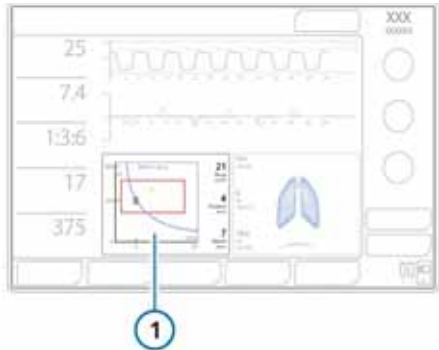

7.4.1 Displaying the ASV Graph

The ASV graph can be displayed in layouts 2 and 3. See Table 6-2.

Figure 7-11 Graphics tab

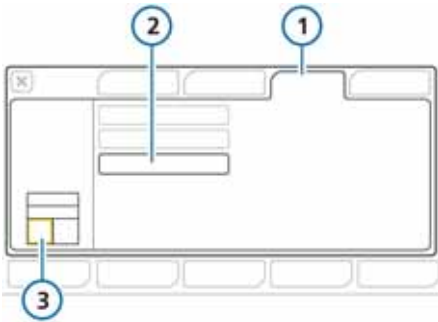

- | | |
|-------------|---|
| 1 Graphics | 3 Selected layout, highlighting the selected display area |
| 2 ASV Graph | |

To display the ASV graph

1. Touch the area of the display where you wish to show the ASV graph panel. See Section 6.3.
2. In the graphics selection window, touch the **Graphics** tab.
3. Touch the **ASV Graph** button.

The ASV target graphic is displayed (Figure 7-10). For details about the graph, see Figure C-3 in Appendix C.

8

Responding to alarms

8.1	Overview	152
8.2	Responding to an alarm	154
8.3	Alarm buffer	155
8.4	About the event log	157
8.5	Alarm troubleshooting table	158

8.1 Overview

The HAMILTON-C3 alarms notify the operator of problems.

These alarms can be categorized as:

- High priority
- Medium priority
- Low priority

Additionally there are other alarms conditions associated with technical fault and technical note alarms, as well as operator messages.

The main monitoring parameters (MMP) change their colors when a corresponding alarm activates. The color reflects the priority of the alarm.

Table 8-1 describes the audio and visual characteristics of these types of alarm and tells you how to respond. Figure 8-1 shows the ventilator’s visual alarm indications.

You can view active alarms in the active alarm buffer (Figure 8-2). Information about the alarm is also stored in an event log (Section 8.4).

When an alarm condition is serious enough to possibly compromise safe ventilation, the device defaults to the ambient state (Appendix B). The inspiratory valve closes, and the ambient and expiratory valves are opened, letting the patient breathe room air unassisted.

For details on setting alarm limits, see Section 4.7.

Table 8-1 Alarm indicators

Alarm type	Message bar	Alarm lamp	Audio	Action required
High-priority alarm	Red, with alarm message	Red, flashing	A sequence of 5 beeps, repeated until the alarm is reset. If the audible alarm is not silenced during the first minute, the continuous-tone buzzer also sounds.	The patient’s safety is compromised. The problem needs immediate attention.
Medium-priority alarm	Yellow, with alarm message	Yellow, flashing	A sequence of 3 beeps, repeated periodically. If the audible alarm is not silenced during the first minute, the continuous-tone buzzer also sounds.	The patient needs prompt attention.

Table 8-1 Alarm indicators

Alarm type	Message bar	Alarm lamp	Audio	Action required
Low-priority alarm	Yellow, with alarm message	Yellow, solid	Two sequences of beeps. This is not repeated.	Operator awareness is required.
Technical fault	Red, with the text, Safety ventilation Safety therapy or Technical fault: xxxxxx	Red, flashing	Same as for high-priority alarm, if technically possible. At a minimum, a continuous buzzer tone. The buzzer cannot be silenced.	The ventilator enters the safety mode, or, if it cannot safely ventilate, the ambient state ^a . Provide alternative ventilation. Turn off the ventilator. Have the ventilator serviced.
Technical event	Depends on severity of the event. Can be low, medium, or high.	Same as the associated alarm level (as described above)	Same as the associated alarm level (as described above).	A technical alarm cannot typically be corrected by the operator. Ventilation continues. Have the ventilator serviced.
Technical note	Provides technical information about a hardware or software issue, displayed only in the Event log.	--	--	No action is required.

a. For more information about Ambient state see Section B.19.

Figure 8-1 Visual alarm indications

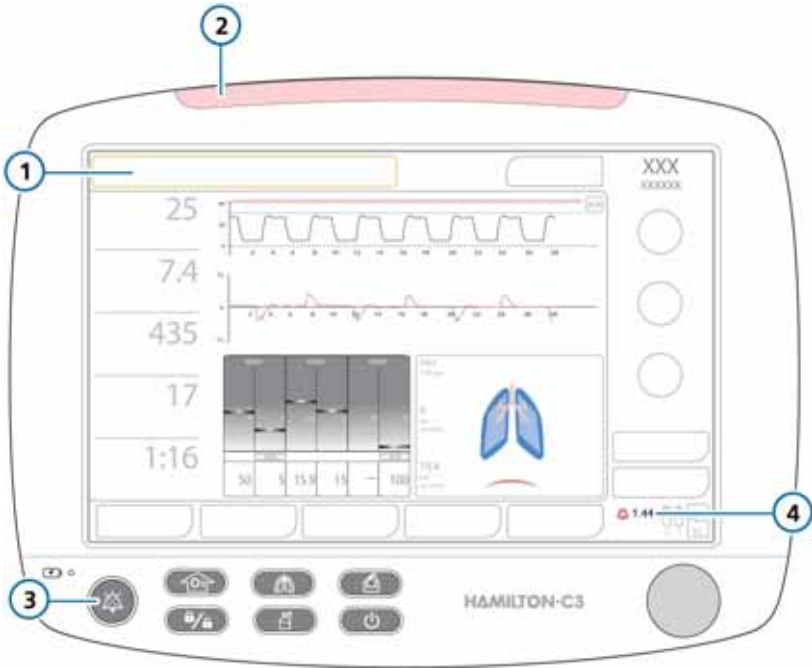

- | | | | |
|---|-------------|---|---------------------------------------|
| 1 | Message bar | 3 | Alarm silence key |
| 2 | Alarm lamp | 4 | Alarm silence indicator and countdown |

For details about the Safety mode and the Ambient state, see Appendix B.

8.2 Responding to an alarm

WARNING

- To prevent possible patient injury when alarms are active, check the patient for adequate ventilation. Identify and remove the cause of the alarms. Readjust the alarm limits only when they are inappropriately set for the current conditions.

- To prevent possible patient injury arising from any issues with the device, Hamilton Medical recommends that you immediately remove any ventilator with a technical fault code, and have the ventilator serviced.

- During an active alarm silence, newly triggered alarms (except for critical alarms) only appear on the display in the message bar and in the Alarm buffer. They do not trigger an audible alarm. The following alarms are considered critical and will trigger an audible alarm:
 - Apnea
 - External power loss
 - Oxygen supply failed
 - Technical event: 231003 (flow controller flow low)
 - Technical event: 243001 (alarm silence error)
 - Technical event: 243002 (alarm unknown)
 - Technical event: 283007 (last settings error)
 - Technical event: 284003 (service needed)
 - Technical event: 285003 (backlight defect)
 - All technical faults

CAUTION

Setting alarm limits to extreme values can render the alarm system useless.

NOTICE

- Be aware that an alarm may result from either a clinical condition or an equipment problem.
- Be aware that one alarm condition can induce multiple alarms. Normally only one or two indicate the root cause of the alarm; the rest are

results. Your search for the causes of the alarm condition should be assisted by, but not limited to, the alarm messages displayed.

To respond to an alarm

1. Approach the patient immediately. Secure sufficient and effective ventilation for the patient. You may silence the alarm if possible.
2. Correct the alarm condition from the alarm messages, referring to Table 8-2. For low-, medium-, and high-priority alarms, when the alarm triggering condition is corrected, the ventilator automatically resets the alarm. For a technical fault alarm, switch off ventilator power first; then correct the problem.

8.3 Alarm buffer

The alarm buffer shows up to six alarm messages:

- If there are currently active alarms, the alarm buffer shows the most recent active alarms (Figure 8-2). The associated alarm messages also alternate in the message bar. Active alarms are shown in boxes with rounded corners.
- If no alarms are active, the alarm buffer shows the most recent inactive alarms (Figure 8-3). Inactive alarms are shown in boxes with square corners.
- High-priority alarms are shown in red.
- Medium- and low-priority alarms are shown in yellow.

To view alarms

- ▶ Open the Alarms -> Buffer window by doing one of the following:
 - Touch the message bar in the upper left-hand corner
 - Touch the inactive alarm indicator (the i-icon) (Figure 8-3)

The most recent alarm is at the top of the list.

To clear the alarm messages for all inactive alarms, touch the **Reset** button (Figure 8-3). Closing the buffer does not erase its contents.

Figure 8-2 Alarm buffer with active alarms (rounded corners)

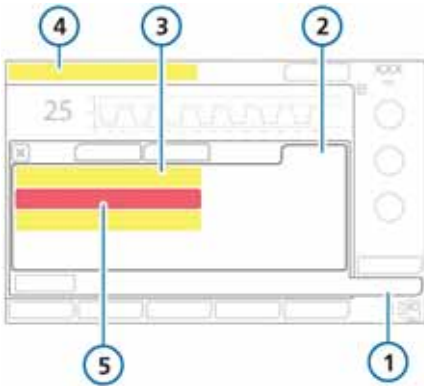

- | | |
|--|-----------------------------|
| 1 Alarms | 4 Currently displayed alarm |
| 2 Buffer | 5 High-priority alarm (red) |
| 3 Low- or medium-priority alarm (yellow) | |

Figure 8-3 Alarm buffer with inactive alarms (square corners)

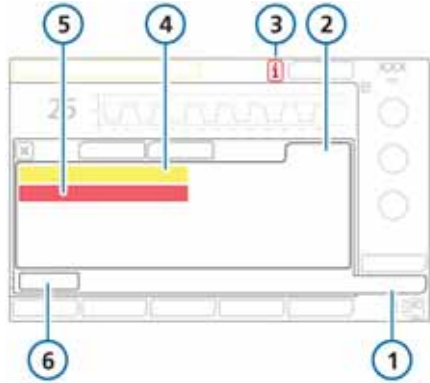

- | | |
|----------|---|
| 1 Alarms | 4 Inactive low- or medium-priority alarm (yellow) |
| 2 Buffer | 5 Inactive high-priority alarm (red) |
| 3 i-icon | 6 Reset button |

8.3.1 Accessing on-screen help for alarms

Troubleshooting help is available for the device alarms.

To view the help for an alarm

1. Touch the alarm message in the buffer.

A help window appears in the buffer, providing troubleshooting information for the selected alarm.
2. To view help for another alarm, touch the next alarm message.

The contents of the help window refresh with the new information. The alarm is displayed as long as the window is open even if the alarm is no longer active.
3. Touch **X** to close the help window.

Figure 8-4 On-screen help window

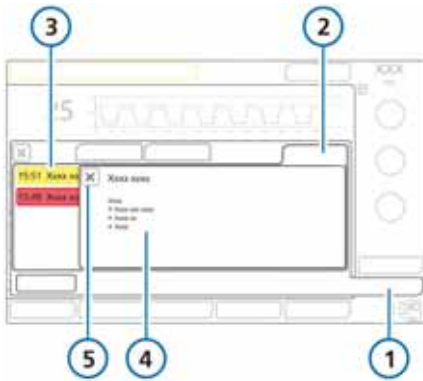

- | | |
|------------------|--|
| 1 Alarms | 4 Alarm text and troubleshooting information |
| 2 Buffer | 5 Close the help window |
| 3 Selected alarm | |

8.4 About the event log

Once the ventilator is turned on, several event logs collect data about clinically relevant ventilator activities, including alarms, technical notes, setting changes, calibrations, maneuvers, and special functions. The date, time, and a unique identification reference (ID) for event classification is included. Alarms are shown in color, depending on priority level (yellow for low or medium, red for high). A more extensive log including technical and configuration details is available to service engineers.

When setting up a new patient:

- Data is appended to the existing event log when you select the **Last patient tab**.
- The event log is cleared and starts anew when you select a different patient group tab (**Adult/Ped.** or **Neonatal**).

Event log data persists after shutting off the ventilator or in the event of a power loss. A maximum of 1000 events is stored. When a log buffer is full, new events overwrite the oldest log entries.

View the event log in the Events window.

Figure 8-5 Events window

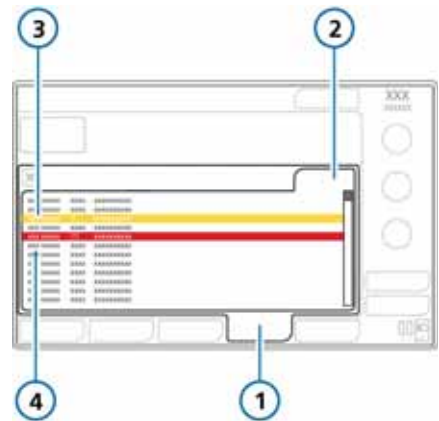

- | | |
|----------|--|
| 1 Events | 3 Low- or medium-priority alarm (yellow) |
| 2 All | 4 High-priority alarm (red) |

8.5 Alarm troubleshooting table

Table 8-2 is an alphabetical list of the alarm messages displayed by the HAMILTON-C3, along with their definitions and suggested corrective actions.

These corrective actions are sequenced to correct the most probable issue or to present the most efficient corrective action first. The proposed actions, however, may not always correct the particular problem.

If your issue is not resolved after performing the recommended tasks, contact your Hamilton Medical authorized service personnel.

Table 8-2 Alarms and other messages

Alarm	Definition	Action needed
Apnea	<i>High priority.</i> No patient trigger within the operator-set apnea time in SPONT, APVsimv (SIMV+), or NIV modes. Apnea backup is off.	<ul style="list-style-type: none"> • Check patient condition. • Check trigger sensitivity. • Consider a mandatory breath.
Apnea ventilation	<i>Low priority.</i> Apnea backup ventilation has started. No breath delivered for the operator-set apnea time. Apnea backup ventilation is on.	<ul style="list-style-type: none"> • Check patient condition. • Check trigger sensitivity. • Check the control settings for the backup mode.
Apnea ventilation ended	<i>Low priority.</i> Backup mode was reset, and HAMILTON-C3 is again ventilating in its original support (pre-apnea) mode.	No action required.
ASV: Cannot meet the target	<i>Low priority.</i> The operator-set %MinVol cannot be delivered, possibly due to setting conflicts or lung-protective rules.	<ul style="list-style-type: none"> • Check patient condition. • Check the P_{asv} limit settings and adjust if appropriate. • Consider a mode change. However, be aware that other modes may not enforce lung-protective rules.
Battery 1, 2: calibration required	<i>Low priority.</i> Battery requires calibration.	Replace the battery with a properly calibrated battery to continue ventilation.

Table 8-2 Alarms and other messages (continued)

Alarm	Definition	Action needed
Battery communication error	<i>High priority.</i> Battery data is not available. Ventilation continues.	<ul style="list-style-type: none"> • Check the battery connectors and that the battery is installed correctly. • Make sure the battery lock is properly closed. • If the problem persists, replace the battery. • If the problem still persists, have the ventilator serviced.
Battery 1,2: Defective	<i>High priority.</i> Battery defective. Ventilation continues if an alternative power source is connected.	<ul style="list-style-type: none"> • Replace battery. • Prepare alternative ventilation. • If the problem still persists, have the ventilator serviced.
Battery low	<p>The low battery alarm has different levels of priority, depending on how much charge is left, and which power supply is in use.</p> <p>At 20% battery charge, the ventilator can generally continue operation for up to approx. 10 min, depending on battery and operating conditions.</p> <p><i>High priority.</i> The ventilator is running on battery power, total battery charge is below 15%.</p> <p><i>Medium priority.</i> The ventilator is running on battery power, total battery charge is below 20%.</p> <p><i>Low priority.</i> The ventilator is running on primary power, total battery charge is below 20%.</p>	<ul style="list-style-type: none"> • Connect the ventilator to a primary power source. • Install charged battery. • If necessary, be prepared to provide alternative ventilation.
Battery power loss	<i>High priority.</i> No battery is present.	<ul style="list-style-type: none"> • Connect the ventilator to primary power (AC/DC). • Insert a battery.
Battery 1, 2: replacement required	<i>Low priority.</i> Battery capacity is insufficient for reliable operation and must be replaced immediately.	<ul style="list-style-type: none"> • Connect the ventilator to primary power (AC/DC). • Replace the battery. • If a replacement is not available, provide alternative ventilation until the issue is resolved. • If the problem still persists, have the ventilator serviced.

Table 8-2 Alarms and other messages (continued)

Alarm	Definition	Action needed
	<p style="text-align: center;">NOTICE</p> <p>Battery life indications are approximate. The actual battery life depends on ventilator settings, battery age, and level of battery charge.</p>	
Battery 1, 2: temperature high	<i>High priority.</i> The battery temperature is higher than expected.	<ul style="list-style-type: none"> • Remove the ventilator from the sun or other heat source. • Replace the battery. • Provide alternative ventilation until the issue is resolved. • If the problem still persists, have the ventilator serviced.
Battery 1, 2: Wrong battery	<i>Low priority.</i> The battery in use is not the correct battery for this ventilator.	<ul style="list-style-type: none"> • Replace the battery with the correct Li-ion battery. • Connect the ventilator to primary power (AC/DC). • Provide alternative ventilation until the issue is resolved.
Battery totally discharged	<i>High priority.</i> The battery charge level is below 5%. The ventilator switches to the Ambient state.	<ul style="list-style-type: none"> • Connect the ventilator to primary power (AC/DC). (Connecting to primary power also charges the battery.) • Provide alternative ventilation until the issue is resolved. • If the problem still persists, have the ventilator serviced.
Blower fault	<i>High priority.</i> A blower malfunction was detected. A technical alarm cannot typically be corrected by the operator. The ventilator switches to the Ambient state.	<ul style="list-style-type: none"> • Immediately provide alternative ventilation. • Have the ventilator serviced.
Blower service required	<i>Low priority.</i> Blower has reached the end of its specified lifespan. Ventilation continues.	Have the ventilator serviced as soon as possible.
Buzzer defective	<i>High priority.</i> A buzzer malfunction was detected. A technical alarm cannot typically be corrected by the operator.	<ul style="list-style-type: none"> • Restart device. • Provide alternative ventilation until the issue is resolved. • If the problem persists, have the ventilator serviced.

Table 8-2 Alarms and other messages (continued)

Alarm	Definition	Action needed
Check CO2 sensor airway adapter	<i>Low priority.</i> One of the following may have occurred: The airway adapter was disconnected from the CO2 sensor. There is an optical blockage on the adapter. The adapter type was changed, but the sensor/adapter was not calibrated.	<ul style="list-style-type: none"> • Check the airway adapter for excessive moisture accumulation and/or contamination by secretions. • Replace airway adapter and calibrate again.
Check CO2 sensor sampling line	<i>Low priority.</i> Sampling line of CO2 sidestream sensor occluded by water.	In case of water occlusion, replace sampling line.
Check flow sensor	<i>High priority.</i> Flow sensor measurements are out of expected range. The ventilator changes to PCV+ mode and displays the internal ventilator pressure (Pvent) instead of airway pressure (Paw). The ventilator returns to the previous mode when measurements are within the expected range.	<ul style="list-style-type: none"> • Make sure the flow sensor is the correct type for the patient (adult/pead vs neonatal). • Check the flow sensor connection to the ventilator. • Connect and calibrate a new flow sensor.
Check flow sensor tubing	<i>High priority.</i> The flow sensor tubes are disconnected or occluded. The ventilator changes to PCV+ mode and displays the internal ventilator pressure (Pvent) instead of airway pressure (Paw). The ventilator returns to the previous mode when measurements are within the expected range.	<ul style="list-style-type: none"> • Check the flow sensor connection to the ventilator. • Connect and calibrate a new flow sensor.
Check patient interface	<i>Low priority.</i> Internal pressure too high during High Flow O2 therapy. Flow cannot be delivered to the patient.	<ul style="list-style-type: none"> • Check patient condition. • Check patient interface and/or reduce flow. • Check patient circuit for kinks.
Check settings	<i>Low priority.</i> A change to a control or alarm setting was not saved.	Check and confirm settings, including alarms.

Table 8-2 Alarms and other messages (continued)

Alarm	Definition	Action needed
CO2 calibration required	<i>Low priority.</i> A previous sensor calibration failed.	<ul style="list-style-type: none"> • Perform the following checks, repeating the calibration after each one, until calibration is successful: • Clean and replace airway adapter. • Re-calibrate the sensor, making sure there is no source of CO2 near the airway adapter. • Connect a new airway adapter. • Install a new CO2 sensor. • If the problem persists, have the ventilator serviced.
CO2 sensor calibration needed	<i>Low priority.</i> Previous sensor calibration failed.	<ul style="list-style-type: none"> • Clean/replace airway adapter • Recalibrate sensor away from CO2 source • Connect new adapter • Connect new sensor • Have the ventilator serviced.
CO2 sensor disconnected	<i>Low priority.</i> The CO2 module is installed, but there is no signal from the CO2 sensor. CO2 monitoring is enabled.	<ul style="list-style-type: none"> • Make sure a CO2 sensor is connected. • Check CO2 sensor connections (CO2 sensor cable to module, CO2 module to ventilator). • Have the ventilator serviced.
CO2 sensor faulty	<i>Low priority.</i> CO2 sensor signal indicates a hardware error or a third-party sensor is installed.	<ul style="list-style-type: none"> • Disconnect the sensor from the CO2 module. Wait a few seconds, and reconnect. • Recalibrate the sensor. Ensure the sensor is attached to the airway adapter during calibration. • Connect a new CO2 sensor. Make sure the sensor is a genuine Hamilton Medical part.

Table 8-2 Alarms and other messages (continued)

Alarm	Definition	Action needed
CO2 sensor over temperature	<i>Low priority.</i> Temperature at CO2 sensor too high.	<ul style="list-style-type: none"> • Check whether the sensor is affected by an external heating source. • Remove the sensor from the airway, and disconnect the sensor from the CO2 module. Reconnect. • Verify that system is running within the specified environmental conditions. Check for excessive airway temperature, which could be caused by defective humidifier, heater wire, or probe.
CO2 sensor warmup	<i>Low priority.</i> CO2 operating temperature not yet reached or unstable.	Wait for sensor to warm up.
Device temperature high	<i>High priority.</i> The internal temperature of the ventilator is higher than expected.	<ul style="list-style-type: none"> • Remove the ventilator from the sun or other heat source. • Check the cooling fan filter and fan. • Prepare alternative ventilation. • Have the ventilator serviced.
Disconnection on patient side	<i>High priority.</i> VTE < 1/8 delivered VTI, and delivered VTI > 50 ml. Applicable in invasive modes. For APRV/DuoPAP, only during pressure phase.	<ul style="list-style-type: none"> • Check patient condition. • Check the breathing circuit for a disconnection between the patient and the flow sensor, or for other large leaks (for example, ET tube).
Disconnection on ventilator side	<i>High priority.</i> VTI measured at the flow sensor < 1/2 delivered VTI measured by the internal sensor, and delivered VTI > 50 ml.	<ul style="list-style-type: none"> • Check the expiratory valve: <ul style="list-style-type: none"> – Check the condition of the expiratory valve and the membrane. If anything is defective, replace. – Check whether the expiratory valve is affected by any nebulizing agent. – Make sure that the expiratory valve is properly installed. – Check whether there is a disconnection at the expiratory valve. • Replace the expiratory valve. • Check the flow sensor. If needed, replace the flow sensor.

Table 8-2 Alarms and other messages (continued)

Alarm	Definition	Action needed
Exhalation obstructed	<p><i>High priority.</i> Either the end-expiratory pressure is too high or the end-expiratory flow is too low. Note that you must use an inspiratory filter to prevent contamination. The ventilator may be contaminated if no inspiratory filter is used. Not active in Hi Flow O2 mode.</p>	<ul style="list-style-type: none"> • Check patient condition. • Check the expiratory limb for occlusion. • Check the expiratory valve membrane and cover. Replace if needed. • Check the flow sensor tubes for occlusion. • Adjust breath timing controls to increase the expiratory time. • Provide alternative ventilation until the issue is resolved. • Have the ventilator serviced.
External flow sensor failed	<p><i>High priority.</i> The external flow sensor doesn't work properly.</p>	<ul style="list-style-type: none"> • Check flow sensor for excessive secretions and/or water accumulation. • Provide alternative ventilation and clean the flow sensor with sterile water. • Connect and calibrate a new flow sensor.
Fan failure	<p><i>Medium priority.</i> There is a problem with the cooling fan.</p>	<ul style="list-style-type: none"> • Provide alternative ventilation until the issue is resolved. • Disconnect the ventilator from the patient. • Have the ventilator serviced.
<div style="background-color: #ffff00; padding: 5px; display: inline-block;">⚠ CAUTION</div> <p><i>A fan failure can result in oxygen enrichment inside the ventilator and present a subsequent fire hazard.</i></p>		
Flow sensor calibration needed	<p><i>High priority.</i> The ventilator does not have correct calibration data or automatic recalibration of the flow sensor is impossible.</p>	<ul style="list-style-type: none"> • Calibrate the flow sensor as soon as possible. • Flow, volume, and pressure readings are less accurate with an uncalibrated flow sensor.
Function key not operational	<p><i>Medium priority.</i> Function key defective. Ventilation continues.</p>	<p>Have the ventilator serviced.</p>

Table 8-2 Alarms and other messages (continued)

Alarm	Definition	Action needed
High frequency	<i>Medium priority.</i> The measured <i>fTotal</i> exceeds the set alarm limit.	<ul style="list-style-type: none"> • Check the patient for adequate ventilation (VTE). • Check alarm limits. • Check the trigger sensitivity. • If the ventilator is in ASV mode, refer to the ASV appendix in the <i>Operator's Manual</i>.
High minute volume	<i>High priority.</i> The measured <i>ExpMinVol</i> exceeds the set alarm limit.	<ul style="list-style-type: none"> • Check patient condition. • Check and confirm settings, including alarms.
High oxygen	<i>High priority.</i> With LPO selected: The measured oxygen exceeds the set high Oxygen alarm limit. With HPO selected: The measured oxygen is more than 5% over the Oxygen control setting.	<ul style="list-style-type: none"> • Calibrate the oxygen cell. • Install a new oxygen cell. • Check alarm limits.
High PEEP	<i>Medium priority.</i> Monitored PEEP exceeds (set PEEP + 5 cmH ₂ O) for two consecutive breaths. <i>For DuoPAP and APRV only:</i> Alarm applies to both P high and P low settings. The alarm sounds when the monitored P high > (set P high + 5 cmH ₂ O) or monitored P low > (set P low + 5 cmH ₂ O) for two consecutive breaths. If T low is set to < 3 s, the High PEEP alarm is disabled for P low settings. This reduces the incidence of false positive alarms.	<ul style="list-style-type: none"> • Check patient condition. • Check and confirm settings, including alarms. • Check the expiratory valve cover and membrane for possible obstructions. • Check for obstructions in the expiratory limb.

Table 8-2 Alarms and other messages (continued)

Alarm	Definition	Action needed
High pressure	<p><i>High priority.</i> The measured inspiratory pressure exceeds the set high Pressure alarm limit. The ventilator immediately closes the inspiratory valve to stop gas flow to the patient and opens the expiratory valve to reduce pressure to the PEEP/CPAP level.</p> <p>If the pressure reaches 15 cmH₂O above the high Pressure alarm limit for longer than 5 s, the ventilator opens the release valve.</p> <p>If the pressure reaches 15 cmH₂O above the high Pressure alarm limit for longer than 7 s, ventilator enters the Ambient state.</p>	<ul style="list-style-type: none"> • Check patient condition. • Adjust the Pressure alarm limit. • Check the artificial airway of the patient for kinks and occlusions. • Check the breathing circuit and flow sensor tubes for kinks and occlusions. • Provide alternative ventilation once the ventilator enters the Ambient state.
High pressure during sigh	<p><i>High priority.</i> A sigh cannot be fully delivered because excessive inspiratory pressure would be required. The sigh is partially delivered.</p>	<ul style="list-style-type: none"> • Check patient condition. • Check the breathing circuit. • Adjust the Pressure alarm limit. • Consider disabling the Sigh function.
High pulse	Pulse rate exceeds set limit.	<ul style="list-style-type: none"> • Check patient condition. • Check and confirm settings, including alarms.
Inspiratory volume limitation	<p><i>Medium priority.</i> The delivered V_t exceeds 1.5 times the set V_t high alarm limit. Pressure is reduced to PEEP level.</p> <p>The APV controls reduce the pressure for the next breath by 3 cmH₂O.</p> <p>Disabled in noninvasive modes.</p>	<ul style="list-style-type: none"> • Reduce the P_{support} setting. • Adjust the V_t high alarm limit.
IRV	<p><i>Low priority.</i> The set I:E ratio is above 1:1, leading to inverse ratio ventilation.</p> <p>Does not apply in APRV.</p>	Check the timing control settings.
Invalid option board	<p><i>Low priority.</i> Installed option board is invalid.</p>	<ul style="list-style-type: none"> • Contact your Hamilton Medical technical representative. • Have the ventilator serviced.

Table 8-2 Alarms and other messages (continued)

Alarm	Definition	Action needed
Loss of external power	<i>Low priority.</i> The ventilator is running on battery power due to loss of a primary power source.	<ul style="list-style-type: none"> • Silence the alarm. • Check integrity of connection to primary power source. • Check battery status. If you have spare batteries, prepare to swap if necessary. • Prepare for possible power loss. • Provide alternative ventilation until the issues is resolved.
Loss of PEEP	<i>Medium priority.</i> Either pressure during exhalation is below (set PEEP/CPAP – 3 cmH ₂ O) for more than 10 s or measured end-expiratory pressure is below (set PEEP/CPAP –3 cmH ₂ O) for two consecutive breaths	<ul style="list-style-type: none"> • Check patient condition. • Check the breathing circuit for leaks. Replace the breathing circuit, if necessary. • Check the condition of the expiratory valve and the membrane. If anything is defective, replace.
Loudspeaker defective	<i>High priority.</i> A loudspeaker malfunction was detected. A technical alarm cannot typically be corrected by the operator. Ventilation continues.	<ul style="list-style-type: none"> • Check patient condition. • Provide alternative ventilation until the issue is resolved. • Have the ventilator serviced.
Low frequency	<i>Medium priority.</i> Measured f _{Total} is below the set alarm limit.	<ul style="list-style-type: none"> • Check patient condition. • Adjust the low f_{Total} alarm limit. • Check the %MinVol and Pat. height settings.
Low minute volume	<i>High priority.</i> Measured ExpMinVol is below the set alarm limit.	<ul style="list-style-type: none"> • Check patient condition. • Check the breathing circuit and artificial airway of the patient for leaks and/or disconnection. • Check and confirm settings, including alarms. • Check the %MinVol and Pat. height settings.
Low oxygen	<i>High priority.</i> Measured oxygen is below the set alarm limit (low-pressure oxygen) or below the operator-set oxygen minus (-) 5% (high-pressure oxygen).	<ul style="list-style-type: none"> • Check patient condition. • Check the oxygen supply. Provide an alternative source of oxygen, if necessary. • Calibrate the oxygen cell. • Provide alternative ventilation and install a new oxygen cell.

Table 8-2 Alarms and other messages (continued)

Alarm	Definition	Action needed
Low pressure	<i>High priority.</i> Set pressure during inspiration not reached.	<ul style="list-style-type: none"> • Check patient condition. • Check the breathing circuit for a disconnection between the patient and the flow sensor, or for other large leaks.
O2 cell calibration needed	<i>Low priority.</i> Oxygen cell calibration data is not within expected range, or cell is new and requires calibration.	<ul style="list-style-type: none"> • Calibrate the oxygen cell. • Verify temperature settings are within environmental specifications. • Replace O2 cell if required. • Have the ventilator serviced.
O2 cell defective	<i>Low priority.</i> The oxygen cell is depleted.	Install a new oxygen cell.
	<p>⚠ CAUTION</p> <p><i>To ensure that oxygen monitoring is always fully functional, replace an exhausted or missing oxygen cell as soon as possible or use an external O2 monitor that complies with ISO 80601-2-55.</i></p>	
O2 cell missing	<i>Low priority.</i> There is no signal from the oxygen cell.	Install an oxygen cell or use an external monitor, according to ISO 80601-2-55.
	<p>⚠ CAUTION</p> <p><i>To ensure that oxygen monitoring is always fully functional, replace an exhausted or missing oxygen cell as soon as possible or use an external O2 monitor that complies with ISO 80601-2-55.</i></p> <p>NOTICE</p> <p>To prevent leakage within the ventilator, make sure an oxygen cell is installed at all times, even if you use an external O2 monitor or disable oxygen monitoring.</p>	
O2 cell not system compatible	<i>Low priority.</i> The incorrect type of oxygen cell is installed.	Ensure oxygen cell is properly installed and a Hamilton Medical oxygen cell is used (PN 396200).
Option not found	<i>High priority.</i> Options were not found during startup.	<ul style="list-style-type: none"> • Restart device. • If the problem persists, have the ventilator serviced.

Table 8-2 Alarms and other messages (continued)

Alarm	Definition	Action needed
Oxygen supply failed	<i>High priority.</i> Oxygen source flow is lower than expected.	<ul style="list-style-type: none"> • Check patient condition. • Check the oxygen supply. Provide an alternative source of oxygen, if necessary. • Check the oxygen source/supply for potential leakage. • Provide alternative ventilation until the issue is resolved.
Performance limited by high altitude	<i>Medium priority. Low after silence.</i> The airway pressure cannot be reached at the current altitude. As long as the device remains above the altitude limit, the pressure cannot be reached, and the alarm is active.	<ul style="list-style-type: none"> • Check patient condition. • If at all possible, consider lowering altitude to reach the target performance. • Provide alternative ventilation until the issue is resolved.
PetCO2 high	<i>Medium priority.</i> PetCO2 exceeds the set alarm limit.	<ul style="list-style-type: none"> • Check patient condition. • Check and confirm settings, including alarms.
PetCO2 low	<i>Medium priority.</i> PetCO2 is below the set alarm limit.	<ul style="list-style-type: none"> • Check patient condition. • Check the breathing circuit and flow sensor/artificial airway of the patient for leaks. • Check and confirm settings, including alarms.
Pressure limit has changed	<i>Low priority.</i> Applies in ASV. The Psvlimit was changed. When this setting is changed, the device automatically adjusts the high Pressure alarm limit to 10 cmH2O above the specified Psvlimit setting.	Make sure the pressure limit is high enough so that sufficient pressure can be applied for adequate breath delivery.
Pressure limitation	<i>Medium priority. Low after silence.</i> Inspiratory pressure, including PEEP/CPAP, is 10 cmH2O below Pressure. The ventilator limits applied pressure, so the target pressure or volume may not be achieved.	<ul style="list-style-type: none"> • Check the patient for adequate ventilation. • Check and confirm settings, including alarms.
Pressure not released	<i>High priority.</i> Airway pressure has exceeded the Pressure limit, and the pressure was not released via the expiratory valve after 5 s. The ventilator enters the ambient state.	<ul style="list-style-type: none"> • Check expiratory valve and breathing circuit for kinks and occlusions. • Provide alternative ventilation until the issue is resolved. • Have the ventilator serviced.

Table 8-2 Alarms and other messages (continued)

Alarm	Definition	Action needed
Preventive maintenance required	<i>Low priority.</i> According to its operating hours, the ventilator requires preventive maintenance.	Have the ventilator serviced as soon as possible.
Real time clock failure	<i>Medium priority.</i> Date and time not set.	Set the date and time (System > Settings window).
Release valve defective	<i>Low priority.</i> During the routine check of the ambient valve during a tightness test, the valve was found to be defective. The alarm is reset when a tightness test is successfully passed. Ventilation is not necessarily affected.	If the problem still persists, have the ventilator serviced as soon as possible.
Replace HEPA filter	<i>Low priority.</i> The air inlet HEPA filter shows increased resistance.	Replace the HEPA filter as soon as possible.
Replace O2 cell	<i>High priority.</i> Communication error, O2 cell defective. Ventilation is not necessarily affected. Oxygen concentration should not be affected by this issue. Ventilation can continue.	<ul style="list-style-type: none"> • Replace oxygen cell. • If you cannot replace the oxygen cell, consider disabling it (System > Sensors on/off window, O2 cell checkbox).
<div style="background-color: #ffff00; padding: 2px;">⚠ CAUTION</div> <p><i>To ensure that O2 monitoring always functions, replace defective/missing O2 cell as soon as possible or use an external O2 monitor complying with ISO 80601-2-55.</i></p>		
RTC failure	<i>Low priority.</i> Date and time not set.	<ul style="list-style-type: none"> • Set date and time. (System < Settings window) • Restart device.
Safety ventilation	<i>Technical fault.</i> A hardware or software issue was detected. The ventilator switches to Safety mode.	<ul style="list-style-type: none"> • Provide alternative ventilation until the issue is resolved. • Have the ventilator serviced.
<div style="background-color: #ffff00; padding: 2px;">⚠ CAUTION</div> <p><i>To prevent possible patient injury arising from issues with the device, Hamilton Medical recommends that you immediately remove any ventilator with a technical fault from use, record the code, and have the ventilator serviced.</i></p>		

Table 8-2 Alarms and other messages (continued)

Alarm	Definition	Action needed
Safety therapy	<p><i>Technical fault.</i> A hardware or software issue was detected. The ventilator switches to Safety mode.</p>	<ul style="list-style-type: none"> • Provide alternative therapy until the issue is resolved. • Have the ventilator serviced.
	<p>⚠ CAUTION</p> <p><i>To prevent possible patient injury arising from issues with the device, Hamilton Medical recommends that you immediately remove any ventilator with a technical fault from use, record the code, and have the ventilator serviced.</i></p>	
Self test failed	<p><i>High priority.</i> The self test failed during startup. The Start ventilation button is ghosted. Note that if this error occurs when the device is restarting from a complete power loss, the device enters the Ambient state.</p>	<ul style="list-style-type: none"> • Restart device. • If the problem persists, have the ventilator serviced. • If the device enters the Ambient state, provide alternative ventilation and have the ventilator serviced.
Sensor fail mode	<p><i>High priority.</i> Flow sensor error.</p>	<ul style="list-style-type: none"> • Check flow sensor for excessive secretions/water accumulation. • Provide alternative ventilation until the issue is resolved and clean flow sensor with sterile water. • Connect/calibrate new flow sensor.
Suctioning maneuver	<p><i>Low priority.</i> Ventilation suppression is active, and ventilator settings are being maintained, although the ventilator is not delivering breaths.</p>	<p>Resume ventilation when desired by first reconnecting the patient.</p>
Technical event: xxxxxx	<p><i>Low, medium, or high priority.</i> A hardware or software issue was detected. A technical alarm cannot typically be corrected by the operator. Ventilation continues.</p>	<p>Contact your Hamilton Medical representative. Have the ventilator serviced.</p>
Technical fault: xxxxxx	<p><i>Technical fault.</i> A hardware or software issue was detected. The ventilator switches to the ambient state or to Safety mode.</p>	<ul style="list-style-type: none"> • Provide alternative ventilation until the issue is resolved. • Have the ventilator serviced.
	<p>⚠ CAUTION</p> <p><i>To prevent possible patient injury arising from issues with the device, Hamilton Medical recommends that you immediately remove any ventilator with a technical fault from use, record the code, and have the ventilator serviced.</i></p>	

Table 8-2 Alarms and other messages (continued)

Alarm	Definition	Action needed
Technical state failed	There is a problem with the hardware configuration. Ventilation is not possible.	<ul style="list-style-type: none"> • Contact your Hamilton Medical representative. • Have the ventilator serviced.
Touch not functional	<i>Low priority.</i> Touch screen defective.	Have the ventilator serviced.
Turn flow sensor	<i>Medium priority.</i> Either the flow sensor is connected to the breathing circuit facing the wrong direction or the flow sensor connections to the ventilator are reversed. Ventilation continues, but the ventilator corrects for the reversed signal.	<ul style="list-style-type: none"> • Check the flow sensor. The end marked PATIENT faces the patient. • Reverse the flow sensor tube connections on the ventilator. • The blue tube attaches to the blue connector. The clear tube attaches to the white connector.
Unknown part number	<i>Technical fault.</i> A hardware or software issue was detected. The ventilator switches to the Ambient state.	<ul style="list-style-type: none"> • Provide alternative ventilation until the issue is resolved. • Have the ventilator serviced.
Ventilation canceled	<i>Technical fault.</i> A hardware or software issue was detected. The ventilator switches to the Ambient state.	<ul style="list-style-type: none"> • Provide alternative ventilation until the issue is resolved. • Contact your Hamilton Medical representative. • Have the ventilator serviced.
Ventilator outlet temperature high	<i>High priority.</i> Inhalation temperature is too high; ventilation continues, but if temperature stays high, ventilator may enter Ambient state	<ul style="list-style-type: none"> • Check whether the room temperature exceeds the ventilator's operating temperature limit. • Check that the air intake on the device is not obstructed. • Provide alternative ventilation until the issue is resolved. • Have the ventilator serviced if temperature cannot be reduced.
Vt high	<i>Medium priority.</i> Measured VTE exceeds the set limit for 2 consecutive breaths. In invasive modes, if the delivered tidal volume is greater than 1.5 times the Vt high limit ($V_t > 1.5 * V_t$ high limit), the Inspiratory volume limitation alarm is generated.	<ul style="list-style-type: none"> • Check the pressure and volume settings for potential leaks and/or disconnections. • Check and confirm settings, including alarms.

Table 8-2 Alarms and other messages (continued)

Alarm	Definition	Action needed
Vt low	<i>Medium priority.</i> Measured VTE is below the set limit for 2 consecutive breaths.	<ul style="list-style-type: none"> • Check patient condition. • Check and confirm settings, including alarms. • Check the breathing circuit and artificial airway of the patient for leaks and/or disconnection. • If the ventilator is in ASV, check for a kinked ET tube.
Wrong flow sensor	<i>High priority.</i> The type of flow sensor connected does not match the selected patient group (Adult/ Ped or Neonatal).	<ul style="list-style-type: none"> • Check the patient group selection. • Connect and calibrate the correct flow sensor.

9

Special functions

9.1	Overview	176
9.2	Standby	176
9.3	Alarm silence	177
9.4	O2 enrichment	178
9.5	Suctioning maneuver	179
9.6	Manual breath	179
9.7	Inspiratory and expiratory hold	180
9.8	Nebulizer	181
9.9	Print screen	182
9.10	Screen Lock/unlock	182

9.1 Overview

Keys on the front of the ventilator provide access to important functions, including entering Standby mode and silencing an alarm.

When a selected function is active, the key backlight changes color.

This chapter describes all of the functions in detail.

Figure 9-1 Special function keys



- | | |
|---------------------------------|------------------------|
| 1 Alarm silence | 5 Nebulizer on/
off |
| 2 O2 enrichment/suc-
tioning | 6 Print screen |
| 3 Screen lock/unlock | 7 Power/
Standby |
| 4 Manual breath | |

9.2 Standby

WARNING

- To prevent possible patient injury due to lack of ventilatory support, secure alternative ventilation for the patient before entering the standby mode. You must confirm that no patient is attached before entering standby.
- To prevent possible patient injury or damage to breathing circuit from overheated gas after reconnection from standby, turn off the humidifier when entering the standby mode.

NOTICE

- To keep the battery fully charged, make sure the ventilator is connected to AC power while in Standby mode.
- When in standby, the ventilator does not automatically resume ventilation when the patient is reconnected. You must manually restart ventilation.
- Patient alarms are suppressed during standby.
- Acoustical patient alarms are suppressed for 1 minute after starting ventilation from standby.

Standby is a waiting mode that lets you maintain ventilator settings while the ventilator is not performing any ventilatory functions.

To put the ventilator into standby

1. Press and quickly release the Power/Standby key while the ventilator is powered on.

The Activate standby window opens.

Figure 9-2 Activate Standby (1) window

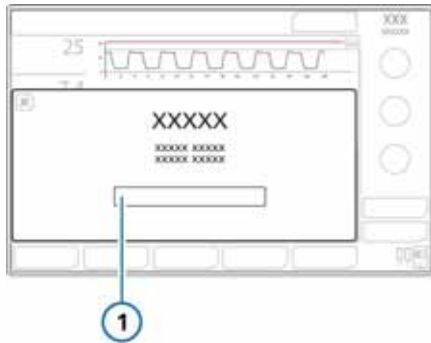

- 1 Activate standby

2. Touch **Activate standby**.

The Standby window opens. See Figure 9-2. When the device is in standby, the Power/Standby key backlight is green.

During standby, the window shows the elapsed time since standby was started.

To start ventilation (end standby)

Do either of the following:

- In the Standby window, (Figure 4-2) touch the **Start Ventilation** button.
- Press and quickly release the Power/Standby key.

Ventilation resumes with the previous settings. The Power/Standby key backlight turns white.

9.3 Alarm silence

NOTICE

The High pressure alarm cannot be silenced.

For details on ventilator alarms, see Chapter 8.

To silence an alarm

- ▶ Press the Alarm silence key.
 - The audible ventilator alarm is muted for 2 min. Pressing the key a second time cancels the alarm silence.
 - The Alarm silence key backlight flashes red when an alarm is active but not muted. It is continuously lit in red while alarm silence is active.

The display also indicates alarm silence is engaged (Figure 8-1):

- A countdown timer on the main display shows the remaining time for the silence.
- The red alarm silence icon is lit.

When the silence expires and the issue has not yet been resolved, the alarm sounds again.

9.4 O2 enrichment

NOTICE

- Oxygen alarms are suppressed while the O2 enrichment function is active.
- O2 enrichment is not available in low pressure oxygen mode.
- When O2 enrichment is active, the O2 enrichment key backlight is green.

Oxygen enrichment is useful for pre- or post-oxygenation before/after tracheal suctioning or for other clinical applications.

In the adult patient group, the O2 enrichment function delivers 100% oxygen for 2 minutes.

In the neonatal patient group, the applied oxygen concentration during the enrichment maneuver is increased by 25% of the last oxygen setting (e.g., if the last oxygen setting = 40%, the resulting oxygen concentration during O2 enrichment maneuver will be 50%).

When active, the green indicator next to the key is lit.

To start oxygen enrichment

- ▶ Press the O2 enrichment key.

After a short time, which is required for the oxygen concentration to rise, the HAMILTON-C3 starts delivering 100% oxygen (adult and pediatric) or the current oxygen setting increased by 25% of the setting (infant/neonate). Afterward, the HAMILTON-C3 resets the concentration to the previous operator-set value.

The currently applied oxygen concentration is displayed on the **Oxygen** control (green).

To stop O2 enrichment manually

Press the key again or touch the **Oxygen** control, which shows the currently set value, and adjust it as needed.

The HAMILTON-C3 resumes ventilation at the set oxygen concentration.

9.5 Suctioning maneuver

NOTICE

- The suctioning maneuver is inactive during NIV and NIV-ST modes.
- The pre- and post oxygenation is displayed with a green O2 control and timer (max. 120 seconds).
- The suctioning maneuver is not available with low pressure oxygen supply.
- Suctioning may affect measured values.

The suctioning maneuver is intended to withdraw an excess of tracheal and/or bronchial secretions in the patient's airways while protecting the user from possible contamination, as well as ensuring the patient's safety during the suctioning maneuver.

When active, the green indicator next to the key is lit.

To perform the suctioning maneuver

1. Press the O2 enrichment key for pre-oxygenation.
2. Disconnect the patient.
Disconnecting the patient halts ventilation so that no gases are blown through the tubes. For 60 seconds all alarms are suppressed.
3. Use a suctioning catheter (not included) to suction all secretions out of the patient's airways.

4. Reconnect the patient to the ventilator.

Post-oxygenation starts and for another 60 seconds all acoustic alarms are suppressed. The alarm message and lamp are still active.

To prematurely terminate the pre- and/or post oxygenation maneuver, press the O2 enrichment key again.

9.6 Manual breath

This function lets you deliver a manually triggered breath.

When active, the Manual breath key backlight is green.

To deliver a manual breath

- ▶ Press and release the Manual breath key (Figure 9-1) during exhalation.
Do not press the key quickly and repeatedly. The manual breath uses the mandatory breath settings (standard or operator set).
If you try to initiate a manual breath during the early stage of inspiration or the early stage of exhalation, the breath will not be delivered.

To deliver a prolonged inspiration

- ▶ Press and hold the manual breath key during any breath phase.

If the ventilator is in exhalation, the device applies a minimum exhalation phase and then switches to inspiration.

It maintains the inspiration pressure until you release the key, or for a maximum of 15 seconds.

if the ventilator is in inhalation, the device maintains the inspiration pressure until you release the key or for a maximum of 15 seconds.

9.7 Inspiratory and expiratory hold

9.7.1 Inspiratory hold

Perform an inspiratory hold using the **Inspiration hold** button. During this maneuver, the inspiratory valve is closed for a short period of time. Perform this maneuver to calculate true plateau airway pressure.

Figure 9-3 Hold window

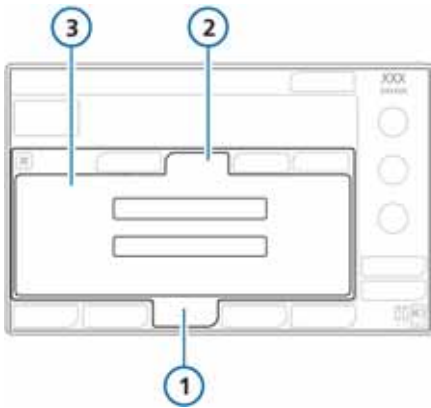

- | | |
|---------|--|
| 1 Tools | 3 Inspiration hold and Expiration hold buttons |
| 2 Hold | |

To perform an inspiratory hold

NOTICE

An inspiratory hold is unavailable during high flow oxygen therapy.

1. Touch the **Tools** button, then touch the **Hold** tab.
2. Touch **Inspiration hold**.

The ventilator performs an inspiratory hold as follows:

- For adult and pediatric patients, the hold is set for 10 seconds
- For neonatal patients, the hold is set for 3 seconds

To stop the inspiratory hold maneuver before this time, touch the **Inspiration hold** button a second time.

At the end of the inspiratory hold, the hold window closes and the frozen waveforms are displayed.

3. Turn the P&T knob clockwise or counterclockwise to scroll through the waveforms for analysis.
4. Touch the **Freeze** button or the P&T knob to unfreeze the display.

9.7.2 Expiratory hold

Perform this maneuver to measure the pressure within airways and the patient's effort and strength for inspiration. It is used to calculate intrinsic PEEP.

NOTICE

- An expiratory hold is unavailable during high flow oxygen therapy.
- The ambient valve of the HAMILTON-C3 opens at -3 cmH₂O below ambient pressure. Pressures values below -3 cmH₂O are not displayed.

The device can perform a manually triggered expiratory hold maneuver for up to a maximum of 10 seconds.

To perform an expiratory hold from the Tools menu

1. Touch the **Tools** button, then touch the **Hold** tab.
2. Touch **Expiration hold**.
The ventilator performs an expiratory hold as follows:
 - For adult and pediatric patients, the hold is set for 10 seconds
 - For neonatal patients, the hold is set for 3 seconds
 To stop the expiratory hold maneuver before this time, touch the **Expiration hold** button a second time.
At the end of the expiratory hold, the hold window closes and the frozen waveforms are displayed.
3. Turn the P&T knob clockwise or counterclockwise to scroll through the waveforms for analysis.
4. Touch the **Freeze** button or the P&T knob to unfreeze the display.

9.8 Nebulizer

⚠ CAUTION

- *Do not use an expiratory filter or HMEF/HME in the patient's breathing circuit during nebulization. Nebulization can cause an expiratory side filter to clog, substantially increasing flow resistance and impairing ventilation.*
- *To prevent the expiratory valve from sticking due to nebulized medications, use only medications approved for nebulization and regularly check and clean the expiratory valve.*

NOTICE

- The pneumatic nebulizer is inactive when low pressure oxygen (LPO) is used.
 - Delivered ventilation is compensated for the contribution of the internal nebulizer so that the expected volume and pressure are delivered.
-  • Pneumatic nebulization is disabled during neonatal ventilation and high flow oxygen therapy. If needed, use an Aerogen nebulizer.

The HAMILTON-C3's pneumatic nebulization function powers a standard inline nebulizer for delivery of prescribed medications in the ventilator circuit. When nebulization is active, the nebulizer flow is synchronized with the inspiratory phase of each breath for 30 min. Nebulization can be activated in all modes of ventilation.

When active, the Nebulizer key backlight is green.

To start nebulization

- ▶ Press the Nebulizer key.

To stop nebulization

- ▶ Press the Nebulizer key again.

For effective nebulization, use a pneumatic nebulizer jar (see Appendix G). Section 2.5 briefly describes how to install the nebulizer.

9.9 Print screen

NOTICE

Touch the HAMILTON-C3 before using the USB port.

The print screen function saves a JPG file of the current ventilator screen to a USB memory drive.

To create a screen shot

1. Insert a USB memory drive into the USB port.
2. Press the Print screen key while the desired display is shown.

The device saves the image to the memory drive. The key backlight is green while the device saves the image.

The filename takes this format:

screenshot_yyyymmdd_hhmmss.jpg

where:

- yyyy is the year
- mm is the month
- dd is the date
- hh is the hour (in 24-hour format)
- mm is the minute
- ss is the second

9.10 Screen Lock/unlock

The Screen Lock/unlock function prevents inadvertent touch screen and device entries. When touching the locked screen, an acoustic BEEP sounds and a *Screen lock active* message is displayed.

When screen lock is active:

- The Screen Lock/unlock key backlight is green.
- Some device controls remain available, while others are disabled, as follows:

- | | |
|-----------------|---|
| Active | <ul style="list-style-type: none">• Alarm silence key• Manual breath key• O2 enrichment key• Nebulizer key |
| Inactive | <ul style="list-style-type: none">• Touch screen• Power/Standby key• Print screen key• P&T knob |

To lock or unlock the screen

- ▶ Press the Screen Lock/unlock key.

10

P/V Tool

10.1	Overview	184
10.2	About the P/V Tool window	185
10.3	Using the P/V Tool	187
10.4	Performing a P/V Tool maneuver	189
10.5	Viewing data	189
10.6	Performing a recruitment maneuver	193
10.7	Closing the P/V Tool	193

10.1 Overview

The P/V Pro Tool™ is a diagnostic and monitoring tool. It helps the clinician to:

- Determine the lung characteristics and lung compliance of problematic patients.
- Define the maximum plateau pressure for ventilation.
- Determine the positive end expiratory pressure (PEEP) that will improve oxygenation, reduce end tidal CO₂, avoid alveoli collapse after a recruitment maneuver, and improve lung compliance.
- Perform a P/V Tool maneuver to assess the total compliance for the entire respiratory system, including the lungs and the chest wall. Lung compliance is recorded in a quasi-static pressure volume curve.
- Perform a recruitment maneuver to open or reinflate collapsed alveoli in the lungs.
- Define recruited volume and calculate when there is no longer extra lung to recruit.

10.1.1 General safety information

WARNING

Do not attempt to use this tool on an active patient as it can cause possible patient discomfort and erroneous readings.

CAUTION

To avoid the risk of infection, prior to performing the recruitment maneuver, inflate the cuff pressure to keep the airway tight.

NOTICE

- The P/V Tool performs a monitoring maneuver that provides information that may be used to optimize PEEP and other ventilator settings. This is just one piece of information that must be considered, however, along with hemodynamic and other clinical conditions. It is the clinician's responsibility to appropriately interpret and apply this information in patient treatment.
- Hamilton Medical recommends you perform the tightness test and flow sensor calibration before using the P/V Tool.

10.1.2 Conditions for use

The following conditions must be met before performing a P/V Tool maneuver:

- The patient is intubated and not breathing spontaneously.
- The breathing circuit is gas tight.
There must be no gas leak throughout the entire system of the ventilator, the breathing circuit, or the ventilated patient.

- Nebulization is deactivated.

The P/V Tool is disabled during nebulization and for five breaths following nebulization.

- The flow sensor must perform optimally.

The accuracy of the information provided depends on the quality of the flow sensor connection. P/V Tool is disabled when the Flow Sensor calibration alarm is active.

- P/V tool is enabled in the following modes: (S)CMV, SIMV, APVcmv, APVsimv, PCV+, PSIMV+, Duopap, APRV, ASV, or INTELLiVENT-ASV.
- P/V Tool is disabled in the following modes: SPONT, NIV, NIV-ST, nCPAP-PS, Apnea backup modes, or HiFlowO2 therapy.
- The patient has received at least five controlled breaths between P/V Tool maneuvers.
- The P/V Tool option is enabled on the ventilator.

10.1.3 Indications for use

The P/V Tool is indicated for adult, pediatric, and neonatal patients, provided that the required conditions are met as described in Section 10.1.2.

10.1.4 Contraindications for use

Use of the P/V Tool is contraindicated if any of the following conditions apply:

- Patients who are breathing spontaneously
- Patients with unstable cardiovascular dynamics
- Patients with confirmed or suspected intracranial hypertension
- Patients who cannot tolerate high intrapulmonary pressure
- Patients vulnerable to barotrauma or volutrauma

10.2 About the P/V Tool window

The P/V Tool controls and graphs are displayed in the Tools > P/V Tool window (Figure 10-1).

Figure 10-1 P/V Tool window

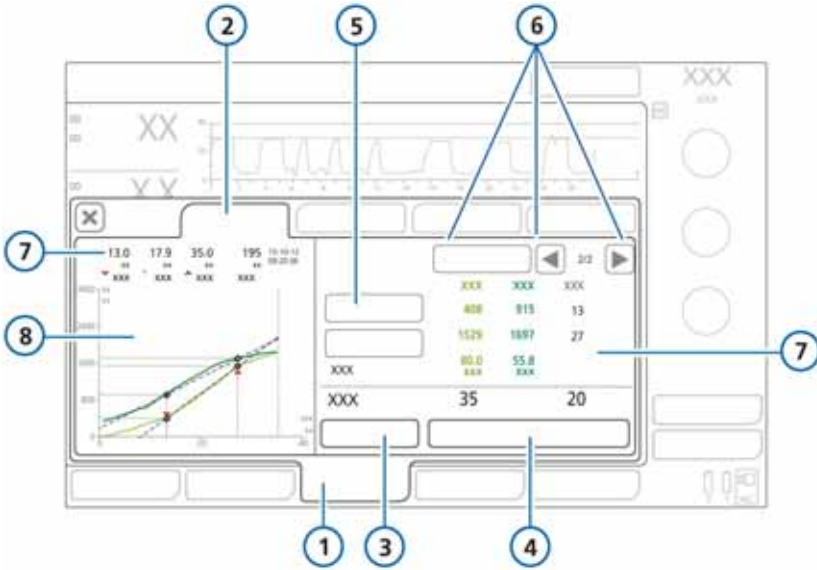

- | | |
|-----------------------|--|
| 1 Tools | 5 Cursors |
| 2 P/V Tool | 6 Reference button and history navigation arrows |
| 3 Settings | 7 Numerical data |
| 4 Start/Stop maneuver | 8 P/V Tool graphics panel |

10.3 Using the P/V Tool

NOTICE

- Before using the P/V Tool, carefully read and understand the safety information at the beginning of this guide.
- For passive patients only.

Using the P/V Tool involves the following steps:

Table 10-1 Using the P/V Tool

Step	See
1 Opening the P/V Tool	Section 10.3.1
2 Adjusting control settings	Section 10.3.2
3 Performing a P/V Tool maneuver	Section 10.4
4 Viewing the data	Section 10.5
5 Using reference curves	Section 10.5.4
6 Performing a recruitment maneuver	Section 10.6
7 Closing the P/V Tool	Section 10.6

Using the P/V Tool does not require any disconnection of the breathing circuit or changes to ventilation settings.

You can use the P/V Tool during active ventilation.

10.3.1 Opening the P/V Tool

To open the P/V Tool

1. Touch the **Tools** button, and then the **P/V Tool** button.

The P/V Tool information window opens.

Be sure to carefully read the safety information before proceeding.

2. Touch **Confirm** to continue.

The P/V Tool window opens (Figure 10-1).

The next step is to adjust the control settings.

10.3.2 Adjusting the control settings

NOTICE

Set **Ptop** to a low value to prevent generation of excessive volumes when performing the recruitment maneuver on patients with obstructive “soft lung” diseases, for example, chronic hypercapnia.

Figure 10-2 P/V Tool settings window

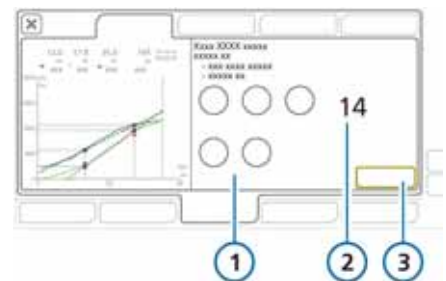

- 1 Control settings (see Table 10-2)
- 2 Calculated Tmaneuver
- 3 Close

You can configure the following control parameters for a P/V Tool maneuver.

Table 10-2 P/V Tool control settings

Control	Description	Default value
Pstart (cmH2O)	Starting pressure	Current PEEP
Ptop (cmH2O)	Target high pressure during the P/V Tool maneuver or recruitment maneuver	35
End PEEP (cmH2O)	End pressure and PEEP to be applied after the maneuver	Current PEEP
Ramp speed (cmH2O/s)	Rate of pressure change; the time taken to reach the target pressure	3
Tpause (s)	Length of the pause during the P/V Tool maneuver; time during which the target pressure will be applied	0
Tmaneuver (s)	The length of the maneuver. This is a calculated value, based on the settings of the above-listed controls.	--

To adjust control settings

1. Touch the **Settings** button.
The Settings window opens (Figure 10-2). For the list of controls, see Table 10-2.
2. Review and, if needed, adjust the settings.

Some controls may require extra steps when adjusting them. These are **Ptop**, **TPause**, and **end PEEP**, as described next.

To set **Ptop** > 40 cmH2O or **Tpause** > 5 s

1. Touch the appropriate control to activate it, and turn the P&T knob to set it to the maximum allowed value (40 for **Ptop**, 5 for **TPause**).
2. Press the P&T knob to accept the setting.
3. To set either parameter beyond this limit, touch the control again and turn the P&T knob to set the value as desired.
4. Press the P&T knob to accept the changed value.

To set the end PEEP to a different setting than PEEP/CPAP

If setting **end PEEP** to a different setting than **PEEP/CPAP**, the device prompts you to confirm the new setting.

- ▶ If required, touch **Yes** or **No** to confirm the PEEP setting.

The next step is to perform a P/V Tool maneuver. See Section 10.4.

10.4 Performing a P/V Tool maneuver

NOTICE

- During the P/T Tool maneuver and for 30 seconds following the end of the maneuver, all patient alarms are silenced.
- During the maneuver, the high pressure alarm is automatically set to $P_{top} + 5$ cmH₂O. Following the maneuver, the high pressure alarm returns to the previous setting.
- Apnea time begins after the end of the maneuver.
- Set a low ramp speed to ensure accurate data when performing a P/V Tool maneuver. Be aware that the ramp speed also dictates the length of the maneuver.
- The length of the maneuver, shown in $T_{maneuver}$, is calculated based on the defined settings.

To perform a P/V Tool maneuver

1. Touch the **Start/Stop maneuver** button.
The device performs a recruitment maneuver for the time defined by the settings.
2. To stop the P/V Tool maneuver before the set time, touch the **Start/Stop maneuver** button.
At the end of the P/V Tool maneuver, ventilation continues and the results of the maneuver are represented both numerically and graphically. See Figure 10-1.

The next step is to view the resulting data. See Section 10.5.

10.5 Viewing data

Data gathered during the P/T Tool maneuver is displayed both graphically and numerically.

Data is displayed as follows:

Viewing data	See
Choosing the data to display	Section 10.5.1
What is displayed numerically	Section 10.5.2
Analyzing the curves	Section
Using reference curves	Section 10.5.4

10.5.1 Choosing the data to display

You can select from three different graph types.

To select a graph

1. Touch the P/V Tool graphics panel.
The graph selection window opens, displaying buttons for each of the available options: Paw/V, Paw/V+Paw/dV and Paw/Flow. See Table 10-3.
2. Touch the desired button.
The window closes and the selected graph is displayed.

Table 10-3 P/V Tool graph types

View	Definition	Graph
Paw/V	<p>Airway pressure to airway volume. The airway pressure in relation to the lung volume. It shows how much pressure is required to inflate the lung at each volume step. See Figure 10-3.</p>	
Paw/V + Paw/dV	<p>Airway pressure to airway volume and the difference in airway volume between the inspiratory limb and the expiratory limb. When this view is selected, the difference in airway volume values are displayed in orange on the right side of the P/V Tool window. See Figure 10-4.</p>	
Paw/Flow	<p>Airway pressure to airway flow. See Figure 10-5.</p>	

Figure 10-3 PAW/V graph



- 1 Deflation limb (dark green)
- 2 Inflation limb (light green)
- 3 ▼ Lower inflection point (LIP)
- 4 ● Point of de-recruitment (PDR)
- 5 ▲ Upper inflection point (UIP)
- 6 Guidelines between points
- 7 Vpeep (volume the lung is inflated when the set PEEP is reached)
- 8 Date and time of maneuver

Figure 10-4 PAW/V + PAW/dV graph

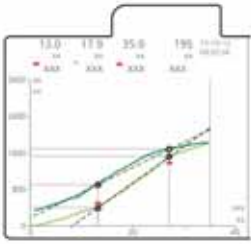
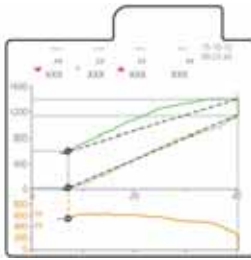
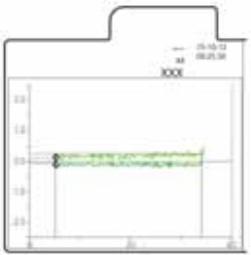
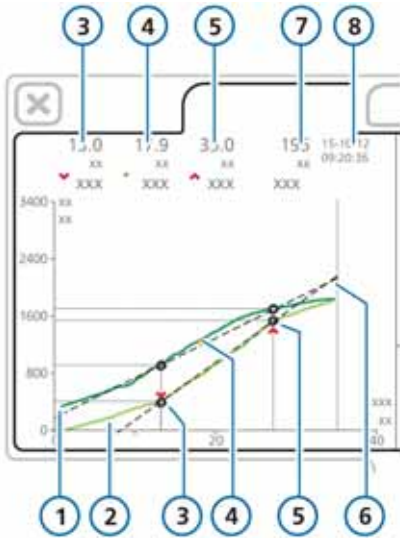
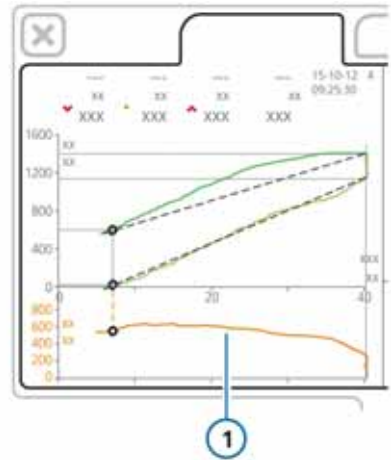

- 1 Delta volume between inflation and deflation limbs curve (orange)

Figure 10-5 PAW/Flow graph

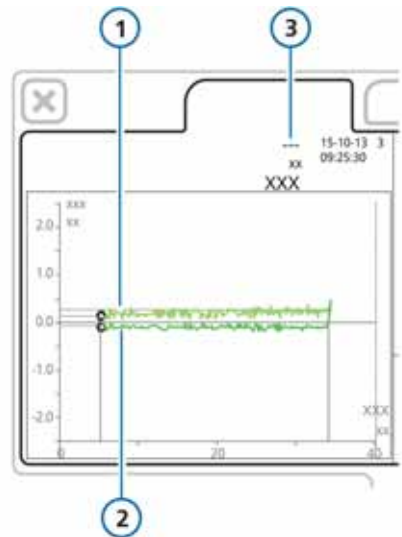

- 1 Inflation limb (light green)
- 2 Deflation limb (dark green)
- 3 Vpeep

10.5.2 Numerical data

Following a P/V Tool maneuver, data is also displayed numerically (Figure 10-6).

Depending on what you select in the P/V Tool window, data is dynamic and the values will change. This allows you to analyze data based on precise values.

Figure 10-6 Displaying numerical data

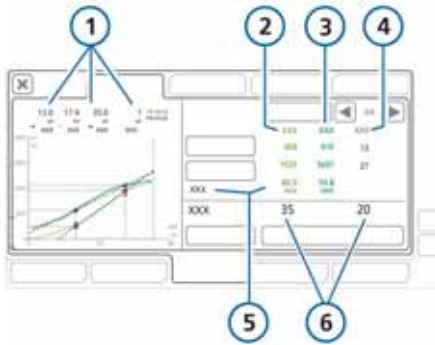

- | | |
|--|------------------------------------|
| 1 LIP, UIP, PDR, vPEEP values
<i>Includes dv when the Paw/V + Paw/dV view is selected</i> | 4 Airway pressure data |
| 2 Inflation limb data (light green) | 5 Compliance |
| 3 Deflation limb data (dark green) | 6 Current Ptop and Tpause settings |

10.5.3 Analyzing the data

Following the P/V Tool maneuver, the inflation and deflation limbs of the maneuver are displayed in the P/V Tool graphics panel.

Use the cursors to move up and down the recorded curves to analyze in precise detail the recorded values on the inflation and deflation limbs.

To move the cursors

1. Touch **Cursor 1** or **Cursor 2** button to select as required (Figure 10-1).
2. Turn the P&T knob clockwise or counterclockwise to move the selected cursor.

As you move the cursors, the displayed data for the inflation limb, the deflation limb, and airway pressure (Paw) update automatically.

3. Touch **Cursor 1** or **Cursor 2** button to deselect as required.

10.5.4 Using reference curves

NOTICE

Stored settings, reference curves, and data are deleted when the device is restarted or ventilation with a new patient is started.

The reference curve is used to compare a patient's progress over time or before and after a recruitment maneuver.

Between 3 and 20 curves can be stored depending on the length of the stored maneuvers. The oldest curves are deleted as new recruitment maneuvers are performed.

You can select one inflation/deflation curve as the reference curve, which you can change at any time. This curve is overlaid in the P/V Tool graphics panel.

Figure 10-7 Displaying a reference curve

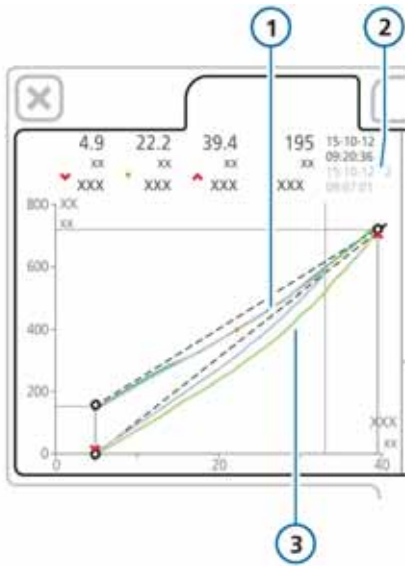

- 1 Reference curve 3 Current curve (gray)
- 2 Time and date associated with the reference curve, and the associated storage number in the history (gray)

To select a reference curve

1. Touch the left or right arrow keys to scroll through the stored curves.
As you scroll through the stored curves, each curve is displayed in gray in the P/V Tool graphics panel. (Figure 10-7)
2. Touch the **Reference** button to set the displayed curve as the reference.
The reference curve is displayed in gray.
The current inflation limb, deflation limb and associated values are displayed in green.

To deselect a reference curve

- ▶ Touch the **Reference** button again to deselect a reference curve.
The curve is no longer displayed in the P/V Tool graphics window.

10.6 Performing a recruitment maneuver

NOTICE

Settings for the recruitment maneuver should be based clinical judgement and the patient condition.

The P/V Tool can also be used to perform a recruitment maneuver. For details, see Section 10.4.

Set **Ptop** to the desired pressure to perform a recruitment maneuver. The duration for the maneuver is determined by **Tpause** and the **Ramp** speed.

Following a recruitment maneuver, the resulting graph shows the volume of the lung that has been recruited.

10.7 Closing the P/V Tool

To close the P/V Tool

- ▶ Select another tab or touch X.

11

Maintenance

11.1§	Overview	196
11.2	Cleaning, disinfection, and sterilization	196
11.3	Preventive maintenance.	199
11.4	Repacking and shipping	205

11.1 Overview

WARNING

No modification of this equipment is allowed. Servicing must be performed by Hamilton Medical-authorized personnel using the instructions provided in the Service Manual.

You must comply with these maintenance procedures to ensure the safety and reliability of the HAMILTON-C3. All the procedures in this manual are to be performed by the operator. For additional maintenance requirements, contact your Hamilton Medical service representative.

Documents referenced in this chapter are available on the MyHamilton website: <https://www.hamilton-medical.com/MyHamilton>

11.2 Cleaning, disinfection, and sterilization

WARNING

- Always disconnect the device from electrical power before cleaning and disinfection to reduce the risk of electric shock.
- DO NOT reuse single-use bacteria filters, flow sensors, and other accessories. They must be discarded after use. Follow your hospital procedures for disposal.
- Reusing, disassembling, cleaning, disinfecting, or sterilizing a single-use part may compromise its functionality and system performance, leading to a possible operator or patient hazard.
- Performance is not guaranteed if an item labeled as single-use is reused.

- Reuse of a single-use product voids the warranty.
- Always use caution when handling bacteria filters to minimize the risk of bacterial contamination or physical damage. Dispose of used filters immediately after use. Follow your hospital procedures for disposal.
- To prevent patient exposure to sterilizing agents and to prevent premature deterioration of parts, sterilize parts using only the techniques recommended in this section and in any associated *Reprocessing Guide* or *Instructions for Use* provided with each part.

CAUTION

- *DO NOT attempt to sterilize the interior components of the ventilator. DO NOT attempt to sterilize the entire device with ETO gas.*
- *Exposure to cleaning and disinfection agents may reduce the useful life of certain parts. Use only the reprocessing methods described in this chapter and in the associated *Reprocessing Guide* to avoid damaging the parts.*
- *(USA only): Only use EPA approved cleaning and disinfection solutions.*
- *Intrusion of fluids, or immersing parts in fluids, will damage the device.*
- *Do not pour fluids onto the device surfaces.*
- *Do not use abrasives materials (for example, steel wool or silver polish) on surfaces.*
- *Incorrect concentrations or residence times of sterilization agents may lead to bacterial resistance.*

NOTICE

- Because sanitation practices vary among institutions, Hamilton Medical cannot specify specific practices that will meet all needs or be responsible for the effectiveness of these practices.
- This manual only provides general guidelines for cleaning, disinfecting, and sterilizing. It is the operator's responsibility to ensure the validity and effectiveness of the actual methods used.
- For specific information on cleaning, disinfecting, and sterilizing autoclavable (reusable) accessories and components, refer to the appropriate *Reprocessing Guide* and *Instructions for Use* provided with each part.
- Dispose of all parts removed from the device according to your institution's protocols. Comply with all local, state, and federal regulations with respect to environmental protection, especially when disposing of the electronic device or parts of it (for example, O2 sensor).

The following sections provide general recommendations for cleaning, disinfecting, and sterilizing parts. For parts not supplied by Hamilton Medical, comply with the manufacturers' recommendations.

DO NOT attempt decontamination procedures unless specified by Hamilton Medical or the original manufacturer.

If you have any questions about the use of a particular cleaning or disinfection agent, contact the manufacturer of the agent.

After cleaning and decontaminating parts, perform any required tests and calibrations described in Chapter 3.

The following sections provide a general overview of how to clean and disinfect ventilator-related parts. Additional information for each part is included in Table 11-1.

11.2.1 General guidelines for cleaning

CAUTION

- *To prevent damage to the ventilator and components, DO NOT clean with hard brushes, pointed instruments, or rough materials.*
- *Cleaning and disinfection agent residues can cause blemishes or fine cracks, especially on parts exposed to elevated temperatures during sterilization.*
- *Thoroughly rinse all patient or airway contact component to insure removal of residual cleaning/disinfection agents.*

Additional information for cleaning each part is included in Table 11-1.

To clean the device parts

1. Disassemble parts. Breathing circuits must be disassembled completely and reprocessed as described in the corresponding reprocessing guide.
2. Wash parts in warm water and soap or an appropriate mild detergent solution.
3. Rinse parts thoroughly with clean, warm water.
4. Air dry.
5. Inspect all parts, and replace if damaged.

6. Sterilize or disinfect the part, following the appropriate sterilization/disinfection procedure as described in the product documentation.
7. Reassemble and reinstall (if needed), and perform any required tests.

11.2.2 General guidelines for disinfection

Additional information for disinfecting each part is included in Table 11-1.

To disinfect the device parts

1. Clean, but DO NOT re-assemble.
2. Disinfect with an appropriate mild bactericidal chemical solution.
3. Reassemble and reinstall parts, and perform any required tests before reuse.

The following table summarizes the cleaning and disinfection guidelines for each major system component.

Table 11-1 Cleaning and disinfection methods parts

Part (material)	How to clean and disinfect	Remarks
Ventilator exterior	Clean and wipe with a damp cloth using a registered/ approved cleaning and disinfection solution after each patient use. Be particularly careful with infectious patients, and follow your hospital infection control procedures.	Do not clean the ventilator interior. This can damage internal parts.
Touch screen	Wipe the screen with a damp, soft cloth using isopropyl alcohol or a nonabrasive glass cleaner.	Lock the screen before cleaning (Section 9.10). Handle the touch screen with care. Do not use any vinegar-based solutions and avoid using gritty cloths.

Table 11-1 Cleaning and disinfection methods parts (continued)

Part (material)	How to clean and disinfect	Remarks
Reusable accessories (such as expiratory valves, SpO ₂ , CO ₂ and flow sensors, nebulizers, filters, masks, adapter, water traps, and breathing circuits)	Follow the instructions provided in the manufacturer's <i>Instructions for Use</i> and corresponding <i>Reprocessing Guide</i> .	
	<div style="background-color: #f4a460; padding: 5px; display: inline-block;">⚠ WARNING</div> <p>Reusing, disassembling, cleaning, disinfecting, or sterilizing the single-use CO₂ airway adapter can compromise its functionality and system performance, leading to a possible user or patient hazard. Performance is not guaranteed if an item labeled as single-use is reused.</p>	

11.3 Preventive maintenance

NOTICE

- Dispose of all parts removed from the device according to your institution's protocols. Comply with all local, state, and federal regulations with respect to environmental protection, especially when disposing of the electronic device or parts of it (for example, oxygen cell, batteries).
- Any attempt to modify the ventilator hardware or software without the express written approval of Hamilton Medical automatically voids all warranties and liabilities.
- Hamilton Medical recommends that you document all maintenance procedures.
- It is not allowed to perform service or maintenance on the device while a patient is connected.

Perform preventive maintenance on your HAMILTON-C3 according to the schedule shown in Table 11-2. You can view the hours of ventilator operation in the System -> Info window. The following subsections provide details for some of these preventive maintenance procedures.

Table 11-2 Preventive maintenance schedule

Interval	Part/accessory	Procedure
Between patients and according to hospital policy	Breathing circuit (including mask, inspiratory filter, flow sensor, nebulizer jar, exhalation valve cover and membrane)	Replace with sterilized or new single-patient use parts. Run the tightness test and the appropriate calibration (Chapter 3).
	Entire ventilator	Run the preoperational checks (Section 3.2).
Every 2 days or according to hospital policy	Breathing circuit	Empty any water from breathing tubes or water traps. Inspect parts for damage. Replace as necessary.
Every month (or more often, if required)	<p>⚠ WARNING</p> <p>To reduce the risk of patient cross-contamination through the fan filter, always perform maintenance at the prescribed interval.</p>	
	Fan filter (rear panel)	Check for dust and lint. If needed, clean or replace.
Every 6 months	Batteries	Recharge batteries by plugging the ventilator into a primary power source for at least 4 hours.
Yearly or every 5000 hours, whichever comes first, or as necessary	Oxygen cell	Replace if depleted.
	<p>NOTICE</p> <p>Oxygen cell life specifications are approximate. The actual cell life depends on operating environment. Operation at higher temperatures or higher oxygen concentrations shortens cell life.</p>	
	Air intake HEPA filter	Replace.
	Ventilator	Perform service-related preventive maintenance. ¹
	CO2 sensor	If the CO2 option is installed, have a CO2 accuracy check performed.
Dynamic lifetime surveillance Typically 8 years	Blower	Replace if indicated. ¹

1. Must be performed by Hamilton Medical authorized service personnel according to instructions in the *Service Manual*.

11.3.1 Servicing the air intake and fan filters

Figure 11-1 summarizes the steps to exchange filters. Instructions follow.

Figure 11-1 Replacing filters

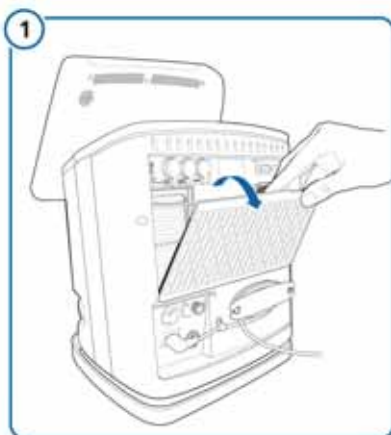

Remove back panel



Remove and replace air intake dust filters

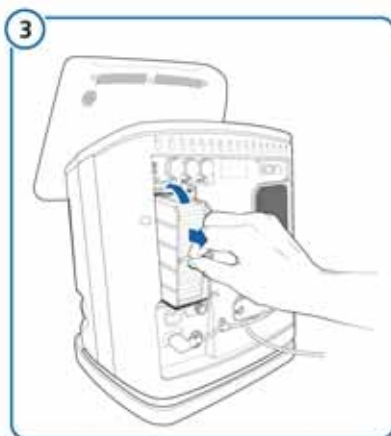

Remove and replace HEPA filter



Remove and replace fan filter

To service the air intake and fan filters

1. Remove the filter cover.
2. Remove the two air intake dust filters.
3. Pull up the retaining clip and pull out the HEPA filter.
4. Replace the HEPA filter with a new one, and pull down the retaining clip to lock it into place.
5. Replace the HEPA filter with a new one, and pull down the retaining clip to lock it into place.
6. Install new air intake dust filters or wash the existing filters in a mild soap solution, rinse, dry, and reinstall.
7. Remove the fan filter.
8. Install a new fan filter or wash the existing filter in a mild soap solution, rinse, dry and reinstall.
9. Reattach the filter cover.

11.3.2 Working with the battery

A backup battery protects the ventilator from low power or failure of the primary power source. An optional second hot-swappable battery is also available.

For additional details, see also:

- For details on batteries, see Section 2.10.
- To replace the battery, see Section 11.3.2.2.
- For charging requirements during storage, see Section 11.3.2.3.
- For specifications and charge times, see Section A.4.

11.3.2.1 Charging and calibrating the battery

The batteries are charged with connected AC or DC power. The battery can also be charged with a Hamilton Medical supplied charger (PN 369104). Calibrating the batteries allows the ventilator to accurately read the remaining charge.

Charge and calibrate the battery with the supplied charger following the instructions provided with the device.

11.3.2.2 Removing and replacing the battery**NOTICE**

- To ensure that the ventilator always has battery backup, keep battery 1 in position at all times during ventilator operation. You can hot-swap battery 2 while the ventilator is operating.
- Be sure to insert and secure the batteries correctly to avoid damaging the battery door.

A side panel on the ventilator provides access to the battery compartment.

To exchange battery

1. Open the battery door.
2. If removing battery 1 (on the left), use a screwdriver to turn the metal locking clip out of the way.
3. For either battery, push up the retaining clip, and slide out the battery.
4. Put in a fully charged battery.
Push up the retaining clip, and push the battery in all the way, ensuring the clip clicks into place, locking in the battery.

5. If replacing battery 1, use a screwdriver to lock the metal clip back in place over the battery.
6. Close the battery door.

Figure 11-2 Exchanging batteries

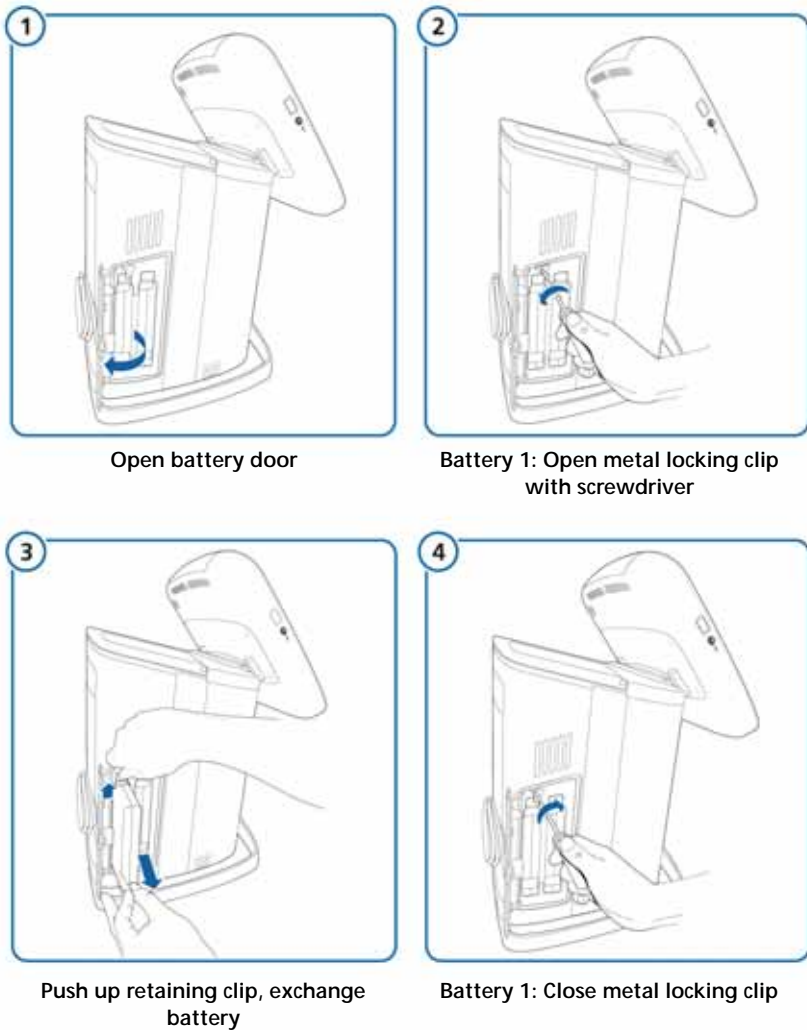

11.3.2.3 Storage

To maintain the battery charge and to prolong the life of the battery, keep the ventilator connected to its primary power source.

Have the battery recharged every 6 months, depending on storage conditions. For details, see Section A.4.

11.3.3 Replacing the oxygen cell

NOTICE

- Replace the oxygen cell with genuine Hamilton Medical parts only; otherwise, oxygen measurement will not function.
- To prevent leakage within the ventilator, make sure an oxygen cell is installed at all times, even if you use an external monitor or disable oxygen monitoring.
- To prevent a permanent alarm use special Hamilton Medical oxygen cells only.

Figure 11-3 Removing the oxygen cell

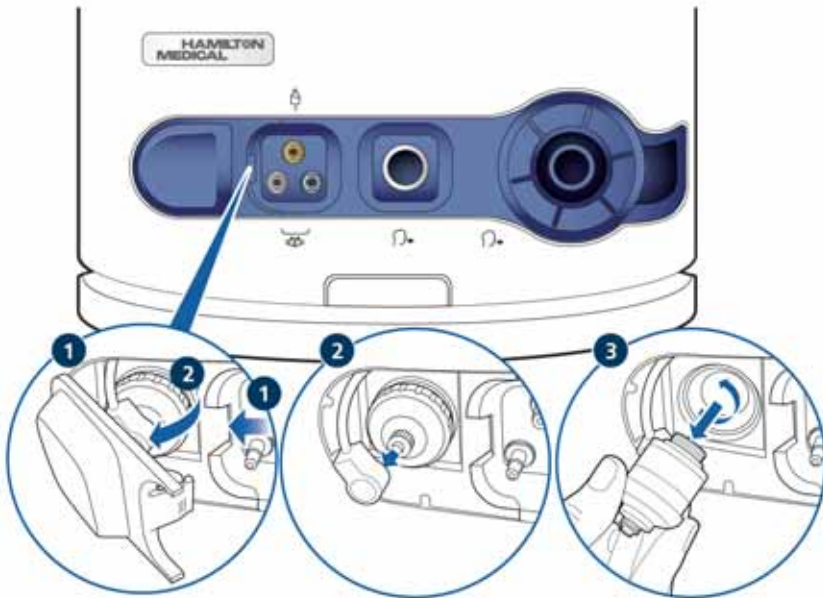
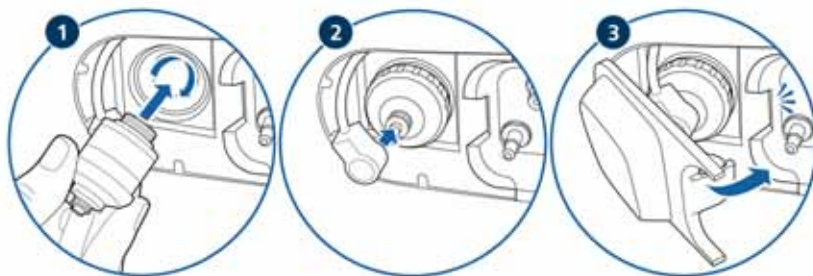

Figure 11-4 Replacing the oxygen cell



11.4 Repacking and shipping

CAUTION

Inform Hamilton Medical if you are shipping a contaminated (nonsterilized and nondisinfected) device for service.

If you must ship the ventilator, use the original packing materials. If these materials are not available, contact your Hamilton Medical representative for replacement materials.

A

Specifications

A.1	Physical characteristics	208
A.2	Environmental requirements	209
A.3	Pneumatic specifications	210
A.4	Electrical specifications	211
A.5	Control settings.	212
A.6	Monitored parameters.	219
A.7	Alarms	224
A.8	Configuration specifications	227
A.9	Ventilator breathing system specifications	229
A.10	Technical performance data.	230
A.11	Standards and approvals	233
A.12	Warranty	234
A.13	Miscellaneous	235

A.1 Physical characteristics

Table A-1 Physical characteristics

Weight	9.5 kg (21 lb)
	38.5 kg (85 lb) with standard trolley
Dimensions	56.5 kg (124.5 lb) with standard trolley and counterweight set 460585
	The trolley can accommodate a maximum safe working load of 80 kg (176 lb). ¹
Dimensions	See Figure A-1

1. The maximum safe working load applies to a stationary properly load-balanced trolley.

Figure A-1 HAMILTON-C3 dimensions

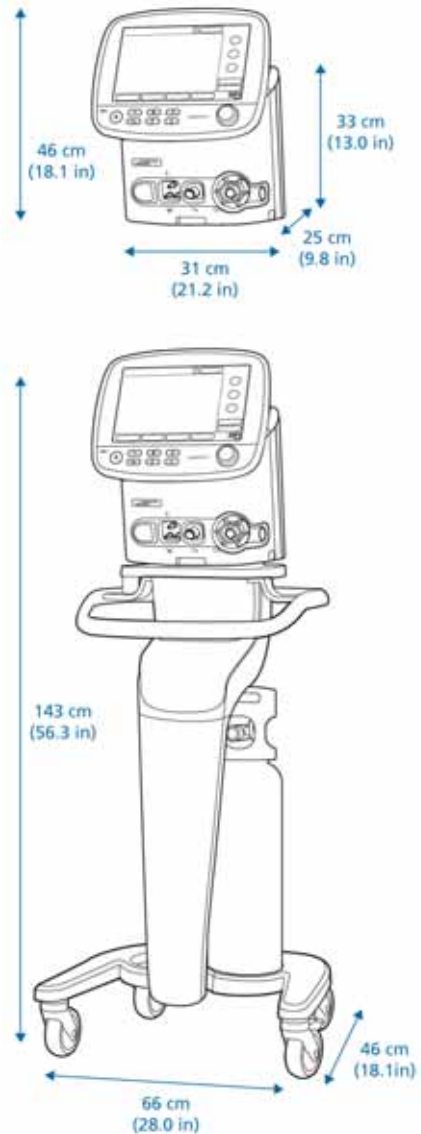

A.2 Environmental requirements

⚠ CAUTION

Ambient temperature < 0°C: The oxygen concentration that is displayed may be inaccurate. Disable O2 monitoring. Ensure that an alternative means of oxygen monitoring is always available and enabled.

Table A-2 Environmental requirements

Temperature	Operating: 5°C to 40°C (41°F to 104°F) Storage: -20°C to 60°C (-4°F to 140°F), in original packaging
Altitude	-650 to 4000 m (-2,132 to 13,123 ft) Note that at higher altitudes the ventilator performance may be limited. A <i>Performance limited by high altitude</i> alarm is generated and a message is shown on the display. See Table 8-2.
Atmospheric pressure	Operating and Storage: 600 to 1100 hPa
Relative humidity	Operating and Storage: 10% to 95%, non-condensing
Water protection	IP21

A.3 Pneumatic specifications

Table A-3 Pneumatic specifications

High-pressure oxygen inlet	<p>Pressure: 2.8 to 6 bar / 280 to 600 kPa / 41 to 87 psi</p> <p>Flow: Maximum of 200 l/min</p> <p>Connector: DISS (CGA 1240) or NIST</p>
Low-pressure oxygen inlet	<p>Peak pressure: ≤ 6 bar / 600 kPa / 87 psi</p> <p>Flow: ≤ 15 l/min</p> <p>Connector: Quick-coupling system, compatible with Colder Products Company® (CPC) PMC series</p>
Air supply	Integrated blower
Gas mixing system	<p>Delivered flow:</p> <ul style="list-style-type: none"> • 240 l/min ±10% against ambient pressure (at sea level) • 0 to 150 l/min with 100% O₂ • Flow accuracy for calibrated flow sensor: <ul style="list-style-type: none"> Adult/Ped: ±10% or ±300 ml/min (whichever is greater) Neonatal: ±10% or ±2 ml/s (whichever is greater) up to 40 l/min <p>Delivered pressure: 0 to 60 cmH₂O</p>
Inspiratory outlet (To patient port)	Connector: ISO 15 mm female/22 mm male conical
Expiratory outlet (From patient port)	Connector (on expiratory valve): ISO 15 mm female/22 mm male conical

A.4 Electrical specifications

Table A-4 Electrical specifications

Input power	100 to 240 VAC $\pm 10\%$, 50/60 Hz 12 to 24 VDC ^{1,2} $\pm 10\%$
Power consumption	50 VA typical, 150 VA maximum
Battery	<p style="text-align: center;">NOTICE</p> <p>Battery life indications are approximate. The actual battery life depends on ventilator settings, battery age, and level of battery charge. To ensure maximum battery life, maintain a full charge and minimize the number of complete discharges.</p> <hr/> <p>Hamilton Medical provides a high-capacity³ battery. Electrical specifications: 10.8 V DC, 6.7 Ah, 72 Wh, 50 W typical, 150 W maximum⁴ Type: Lithium-ion, supplied by Hamilton Medical only Operating time: Operating times⁵ are measured with one or two fully charged batteries, the blower in use, without option board, and with the following settings: VT = 500 ml, Rate = 15 b/min, Pcontrol = 30 cmH₂O, PEEP = 0 cmH₂O Approximate operating times under these conditions are as follows:</p> <ul style="list-style-type: none"> • One battery, display brightness = 80%: 3.5 h • One battery, display brightness = 20%: 3.8 h • Two batteries, display brightness = 80%: 7 h • Two batteries, display brightness = 20%: 8 h <p>By default, display brightness on the device is set to 80%, so operating times of 3.5 h with one battery and 7 h with two batteries are typical.</p>

Table A-4 Electrical specifications

<p>Battery (<i>cont.</i>)</p>	<p>This operating time applies to new, fully charged Li-ion batteries not exposed to extreme temperatures. The actual operating time depends on battery age and on how the battery is used and recharged.</p> <p>Recharge time: While ventilator is connected to primary power, approximately 2.25 h to fully recharge one battery, approximately 4.5 h to fully recharge two batteries.</p> <p>Storage: -20°C to 50°C, ≤ 95% relative humidity. Storage place should be free from vibration, dust, direct sunlight, moisture, and corrosive gases, and with a recommended temperature range < 21°C. Extended exposure to temperatures above 45°C could degrade battery performance and life.</p>
<ol style="list-style-type: none"> 1. Batteries are charged when power is > 20 VDC. Only use of the Hamilton Medical DC adapter ensures that the internal batteries are charged. 2. When the voltage exceeds 27.5 VDC, the device automatically switches to battery power, and continues ventilation as set. 3. Battery revision 3 and later 4. These specifications apply to batteries revision 3 and later. For earlier battery revisions, the following specifications apply: 10.8 VDC, 6.7 Ah, 72 Wh, 50 W typical, 150 W maximum. 5. The listed operating times and conditions apply to batteries revision 3 and later. For earlier battery revisions, the following specifications apply: Operating time with one battery in use (with turbine in use and the following settings: C = 15 ml/cmH₂O, Rate = 10 b/min, P_{insp} = 10 cmH₂O, PEEP = 5 cmH₂O): 2.5 h minimum, 3 h typical. 	

A.5 Control settings

Table A-5 provides the control parameter ranges, default settings, and accuracy of measurements.

NOTICE

- Some modes are available as options, and may not be available in all countries or on all devices.
- Some default settings are configurable.
- The following parameters are based on ideal body weight (IBW): Vt, Rate, T high, T low, and TI
- The following parameters are set based on body weight (neonatal): Vt, Rate, T low, T high, TI, and TI max



Table A-5 Control settings, ranges and accuracy



Parameter or Setting (units)	Range		Default settings		Accuracy ¹
	Adult/Ped	Neonatal 	Adult/Ped	Neonatal 	
Apnea backup	On, Off	On, Off	On	On	
ETS ^{2,3} (%)	5 to 80	5 to 80	25 <i>In noninvasive modes:</i> 35	25 <i>In noninvasive modes:</i> 35	
Flow ⁴ (l/min)	2 to 80	2 to 12	15	2	±10% or ±1 l/min, whichever is greater
Flow pattern ⁵	Square, 50 % decelerating, Sine, 100 % decelerating	--	50% decelerating	--	
Flow trigger ⁶ (l/min)	<i>APVcmv, (S)CMV, PCV+:</i> 1 to 20, Off <i>Other modes:</i> 1 to 20	<i>APVcmv, PCV+, (S)CMV:</i> 0.1 to 5.0, Off <i>Other modes:</i> 0.1 to 5.0	5	0.5	±10%
Height	<i>See Pat. height</i>				
I:E ¹⁶	1:9 to 4:1	1:9 to 4:1	1:4	1:3	--
%MinVol ⁷ (%)	25 to 350	--	100	--	
Mode	APVcmv, APVsimv, PCV+, SMCV, ASV, SIMV, APRV, SPONT, NIV, INTELLiVENT-ASV, NIV-ST, DuoPAP, HiFlowO2	APVcmv, PCV+, SIMV+, PSIMV+, SPONT, nCPAP-PS, NIV, NIV-ST, DuoPAP, APRV, HiFlowO2	ASV	PSIMV+	
Oxygen (%)	21 to 100	21 to 100	50	40	± (volume fraction of 2.5% + 2.5% gas level)
Pause ⁸	0-70	--	0	--	

Table A-5 Control settings, ranges and accuracy (continued)



Parameter or Setting (units)	Range		Default settings		Accuracy ¹
	Adult/Ped	Neonatal 	Adult/Ped	Neonatal 	
Pasvlimit ⁷ (cmH ₂ O)	5 to 60	--	30	--	±5% or ±1 cmH ₂ O, whichever is greater
Pat. height (cm) (in)	30 to 250 12 to 98	--	174 69	--	
Pcontrol ⁹ (cmH ₂ O)	5 to 60	3 to 60	15	15	±5% or ±1 cmH ₂ O, whichever is greater
Peak flow ¹⁰	1-195	--	60	--	
PEEP/CPAP (cmH ₂ O)	0 to 35	0 to 25	5	5	±5% or ±1 cmH ₂ O, whichever is greater
Pinsp ¹¹ (cmH ₂ O)	3 to 60	<i>nCPAP-PS:</i> 0 to 60 <i>Other modes:</i> 3 to 60	15	15	±5% or ±1 cmH ₂ O, whichever is greater
P high (cmH ₂ O) <i>in DuoPAP</i>	0 to 60 <i>absolute pressure</i>	0 to 60 <i>absolute pressure</i>	20	20	±5% or ±1 cmH ₂ O, whichever is greater
P high (cmH ₂ O) <i>in APRV</i>	0 to 60 <i>absolute pressure</i>	0 to 60 <i>absolute pressure</i>	20 <i>startup setting = PEEP + 15</i>	20 <i>startup setting = PEEP + 15</i>	±5% or ±1 cmH ₂ O, whichever is greater
P low (cmH ₂ O) <i>in APRV</i>	0 to 35	0 to 25	5	5	±5% or ±1 cmH ₂ O, whichever is greater
P-ramp ¹² (ms)	0 to 2000 <i>ASV, NIV, NIV-ST, SPONT:</i> max = 200	0 to 600 <i>NIV, NIV-ST, SPONT, nCPAP-PS:</i> max = 200	100	50	±10 ms

Table A-5 Control settings, ranges and accuracy (continued)





Parameter or Setting (units)	Range		Default settings		Accuracy ¹
	Adult/Ped	Neonatal 	Adult/Ped	Neonatal 	
Pressure trigger (cmH2O)	<i>APVcmv, (S)CMV, PCV+:</i> -0.1 to -15.0, Off <i>Other modes:</i> -0.1 to -15.0	<i>APVcmv, (S)CMV, PCV+:</i> -0.1 to -15.0, Off <i>Other modes:</i> -0.1 to -15.0	-2.0	-1.0	±10%
Psupport ¹³ (cmH2O)	0 to 60	0 to 60	15	15	±5% or ±1 cmH2O, whichever is greater
Rate ¹⁹ (b/min)	<i>APVcmv, (S)CMV, PCV+:</i> 4 to 80 <i>PSIMV+, NIV-ST:</i> 5 to 80 <i>Other modes:</i> 1 to 80	<i>APVcmv, PCV+, PSIMV+, NIV-ST, PSIMV (non Psync):</i> 15 to 150 <i>nCPAP-PS:</i> 5 to 150 <i>Other modes:</i> 1 to 150	<i>3.0 to 5.8</i> <i>IBW: 38</i> <i>5.9 to 8.0</i> <i>IBW: 32</i> <i>8.1 to 20.0</i> <i>IBW: 25</i> <i>20.1 to 29.9</i> <i>IBW: 19</i> <i>30 to 39 IBW:</i> <i>17</i> <i>40 to 59 IBW:</i> <i>15</i> <i>60 to 139</i> <i>IBW: 12</i>	<i>0.2 to 1.25 kg:</i> 60 <i>1.26 to 3.0 kg:</i> 45 <i>3.1 to 5.9 kg:</i> 35 <i>6.0 to 8.9 kg:</i> 30 <i>9.0 to 20.5 kg:</i> 25 <i>21 to 30 kg:</i> 20	Adult: ±1 Neo: ±1 < 100 ±3 ≥ 100
Gender	Male, Female	not shown	Male		
Sigh ¹⁴	On, Off		Off		
T high ¹⁹ (s) <i>in DuoPAP</i>	0.1 to 40	0.1 to 40	Based on rate (IBW) and I:E = 1:4	Based on rate (Weight) and I:E = 1:3	±0.01 s
T high ¹⁹ (s) <i>in APRV</i>	0.1 to 40	0.1 to 40	Based on rate (IBW) and I:E = 9:1	Based on rate (Weight) and I:E = 7:1	±0.01 s
Ti ^{15,16,19} (s)	0.1 to 12	0.1 to 12	Based on rate (IBW) and I:E = 1:4	Based on rate (Weight) and I:E = 1:3	±0.01 s
Tl max ¹⁷ (s)	1 to 3	0.25 to 3.0	1.5	1.0 s ≤ 10 kg 1.5 s > 10 kg	± 0.1 s

Table A-5 Control settings, ranges and accuracy (continued)

Parameter or Setting (units)	Range		Default settings		Accuracy ¹
	Adult/Ped	Neonatal 	Adult/Ped	Neonatal 	
T low (s) <i>in APRV</i>	0.2 to 40	0.2 to 40	Based on IBW, 9:1	Based on Weight, 7:1	± 0.01 s
TRC expiration	ON, OFF	ON	ON, OFF	ON	
TRC tube type	ET tube, Trach tube, or TRC OFF	ET tube, Trach tube, or TRC OFF	TRC OFF	TRC OFF	
TRC tube size (mm)	3 to 10	2.5 to 5.0	7	3.5	
TRC compensation ¹⁸ (%)	0 to 100	0 to 100	80	80	
TRC Expiration	ON, OFF	ON, OFF	ON	ON	--
TRC Tube type	ET tube, Trach tube, Disable TRC	ET tube, Trach tube, Disable TRC	Disable TRC	Disable TRC	--
TRC Compensation	0 to 100%	0 to 100%	80%	80%	--
TRC ID (tube size) (mm)	3 to 10	2.5 to 5.0	7	3.5	--
V _t ¹⁹ (ml)	20 to 2000	2 to 300	Based on IBW	Based on Weight	Adult: ±10% or ±10 ml, whichever is greater Neo: ±10% or ±2 ml, whichever is greater
V _T /kg ²⁰ (ml/kg)	5 to 12	5 to 12	8	5	
Weight ²⁰ (kg)	--	0.2 to 30.0	--	2.0	

1. The stated accuracy includes the tolerance interval for each measurement. See Section A.10.1 for details.
2. Expiratory trigger sensitivity, in % of inspiratory peak flow.
3. When selecting a noninvasive mode, the device uses the ETS value used in the previous mode, if available. If the previous mode did not use ETS, the device sets ETS to 35.
4. HiFlowO2 therapy only
5. Parameter dependent on ventilation philosophy, set in Configuration.
6. Flow trigger is leak compensated.
7. In ASV mode only.
8. Limited to 25% of TI.

-
9. Control pressure, added to PEEP/CPAP.
 10. Limitation changes based on flow pattern and Vt.
 11. Inspiratory pressure, added to PEEP/CPAP.
 12. P-ramp is limited by one-third (1/3) of TI time. Adjustment of TI time can override P-ramp setting. Limitation in ASV, SPONT, NIV, NIV-ST, nCPAP-PS: max 200 ms.
 13. Pressure support, added to PEEP/CPAP.
 14. Sigh is disabled in DuoPAP, APRV, and for neonates.
 15. Inspiratory time; used with Rate to set the breath cycle time.
 16. In PCV+, (S)CMV, SIMV and APVcmv modes, mandatory breath timing can be controlled by using a combination of inspiratory time (TI) and rate, or by the I:E ratio; set the method in Configuration. All other modes are controlled by using a combination of inspiratory time (TI) and rate.
 17. Maximum inspiratory time for spontaneous breaths during noninvasive ventilation.
 18. Set to 0% to have Ptrachea displayed without compensation.
 19. Startup setting derived from body weight setting (neonates), IBW (adults/pediatrics). Does not apply in ASV mode.
 20. Set in configuration. IBW calculated for adult/pediatrics; for neonates, actual body weight is used.

Table A-6 Controls active in HAMILTON-C3 ventilation modes

Mode type	Closed-loop		Mandatory			SIMV					DuoPAP/APRV		Pressure support		Neonatal		
	ASV	INTELLIVENT-ASV	PCV+	APVcmv	(S)CMV	Psync	PSIMV+	APVsimv	SIMV	NIV-ST	DuoPAP	APRV	SPONT	NIV	nCPAP-PS	Rate	TI
Timing	--	--					Rate				T low	--					
	--	--	I/E	I/E/ Pause, TI/ Pause, or Peak flow/Tip	I/E/ Pause, TI/ Pause, or Peak flow/Tip	TI	TI			TI	T high	--					TI
Mandatory breaths	--	--	Pcontrol	Vt		Pinsp	Pcontrol	Vt		Pinsp	P high	--					Pinsp
Spontaneous breaths			--					Psupport			Psupport	--					
		ETS	--	--					ETS			--		ETS			ETS
Baseline pressure		Automatic PEEP/CPAP															TI max ¹
		Automatic PEEP/CPAP															TI max ¹
General																	
ASV-specific																	
	%MinVol	Automatic %MinVol															n/a
		Passlimit															

1. For neonatal only

A.6 Monitored parameters

Table A-7 provides the monitored parameter ranges, default settings, and accuracy of measurements.

Table A-8 lists the ranges of the real-time curves and loops. Pressure, flow, and volume measurements are based on readings from the flow sensor, and are expressed in BTPS (body temperature and pressure saturated).

You can show all monitored parameters as 1-, 6-, 12-, 24-, or 72-h trends.

Table A-7 Monitored parameters, ranges, and accuracy

Parameter (units)	Range		Accuracy ¹
	Adult/Ped	Neonatal 	
Pressure			
PEEP/CPAP (cmH ₂ O)	0 to 80	0 to 80	± (2 cmH ₂ O + 4% of actual reading)
Pinsp ² (cmH ₂ O)	0 to 80	0 to 80	± (2 cmH ₂ O + 4% of actual reading)
Pmean (cmH ₂ O)	0 to 80	0 to 80	± (2 cmH ₂ O + 4% of actual reading)
Ppeak (cmH ₂ O)	0 to 80	0 to 80	± (2 cmH ₂ O + 4% of actual reading)
Pplateau (cmH ₂ O)	0 to 80	0 to 80	± (2 cmH ₂ O + 4% of actual reading)
AutoPEEP (cmH ₂ O)	0 to 80	0 to 80	
Flow			
Control flow ³ (l/min)	2 to 80	2 to 12	
Insp flow, peak (l/min)	0 to 260	0 to 260	<i>Adult:</i> ±10% or ±20 ml/s, whichever is greater <i>Neo:</i> ±10% or ±2 ml/s, whichever is greater

Table A-7 Monitored parameters, ranges, and accuracy (continued)

Parameter (units)	Range		Accuracy ¹
	Adult/Ped	Neonatal 	
Exp flow, peak (l/min)	0 to 260	0 to 260	<i>Adult:</i> ±10% or ±20 ml/s, whichever is greater <i>Neo:</i> ±10% or ±2 ml/s, whichever is greater
Volume			
ExpMinVol ⁴ or MinVol NIV ⁵ (l/min)	0 to 99.9	0 to 99.9	±10% or ±0.3 l/min, whichever is greater
MVSpont ⁴ or MVSpont NIV ⁵ (l/min)	0 to 99.9	0 to 99.9	±10% or ±0.3 l/min, whichever is greater
VTE ⁴ or VTE NIV ⁵ (ml)	0 to 9000	0 to 9000	<i>Adult:</i> ±10% or ±10 ml, whichever is greater <i>Neo:</i> ±10% or ±2 ml, whichever is greater
VTI (ml)	0 to 9000	0 to 9000	<i>Adult:</i> ±10% or ±10 ml, whichever is greater <i>Neo:</i> ±10% or ±2 ml, whichever is greater
VLeak (%)	0 to 100	0 to 100	±10% (for leak volumes between 100 and 2000 ml)
MVLeak (l/min)	0 to 99.9	0 to 99.9	±10% or ±0.3 l/min, whichever is greater
Time			
I:E	9.9 to 1:99	10:1 to 1:99	--
fControl (b/min)	0 to 999	0 to 999	±1 b/min
fSpont (b/min)	0 to 999	0 to 999	±1 b/min
fTotal (b/min)	0 to 999	0 to 999	±1 b/min
TI (s)	0 to 60	0 to 60	±100 ms
TE (s)	0 to 60	0 to 60	±100 ms

Table A-7 Monitored parameters, ranges, and accuracy (continued)



Parameter (units)	Range		Accuracy ¹
	Adult/Ped	Neonatal 	
Other calculated and displayed parameters			
Cstat (ml/cmH2O)	0 to 300	0 to 300	--
IBW ⁶ (kg)	3 to 139 <i>default: 70</i>	--	--
P0.1 (cmH2O)	-99 to 0	-99 to 0	--
PTP (cmH2O * s)	0 to 99	0 to 99	--
RCexp ⁷ (s)	0.0 to 99.9	0.0 to 99.9	--
Rinsp (cmH2O / l/s)	0 to 999	0 to 999	--
Trigger	No or Yes	No or Yes	
VTESpont (ml)	0 to 9000	0 to 9000	±10% or ±10 ml, whichever is greater
Weight (kg)	--	0.2 to 30 kg	
Oxygen			
Oxygen (%)	18 to 105	18 to 105	± (volume fraction of 2.5% + 2.5% of gas level)
CO2⁸			
FetCO2 (%)	0 to 20	0 to 20	CO2 (BTPS): 0 to 40 mmHg (0 to 5.3 kPa): ±2 mmHg (0.3 kPa) 41 to 70 mmHg (5.4 to 9.3 kPa): ±5% of reading 71 to 100 mmHg (9.4 to 13.3 kPa): ±8% of reading 101 to 150 mmHg (13.4 to 20.0 kPa): ±10% of reading
PetCO2 (mmHg)	0 to 150	0 to 150	
(kPa)	0 to 20	0 to 20	
slopeCO2 ⁹ (%CO2 / l)	0 to 99.9	0 to 99.9	--
Vtalv ⁹ (ml)	0 to 9999	0 to 9999	--
V'alv ⁹ (l/min)	0 to 20	0 to 20	--
V'CO2 ⁹ (ml/min)	0 to 9999	0 to 9999	--
VDaw ⁹ (ml)	0 to 999	0 to 999	--
VDaw/VTE ⁹ (%)	0 to 100	0 to 100	--
VeCO2 ⁹ (ml)	0 to 999	0 to 999	--

Table A-7 Monitored parameters, ranges, and accuracy (continued)

Parameter (units)	Range		Accuracy ¹
	Adult/Ped	Neonatal 	
ViCO ₂ ⁹ (ml)	0 to 999	0 to 999	--

1. The stated accuracy includes the tolerance interval for each measurement, except for measurements displayed from external sensors (CO₂). See Section A.10.1 for details.
2. Target inspiratory pressure in ASV.
3. For HiFlowO₂ only.
4. Used only with invasive modes.
5. The NIV parameter is used with noninvasive modes.
6. IBW is calculated using height and gender, and is used for adult and pediatric patients. Actual body weight is used for neonates.
7. Least square fit method.
8. Only available if the CO₂ option board is installed and the CO₂ sensor is enabled.
9. For mainstream CO₂ only.

Table A-8 Real-time waveforms and loops

Parameter	Range		Y-axis scale
	Adult/Ped	Neonatal 	

Real-time waveforms

All waveforms show Time on the x-axis.

The time scale options for the x-axis are as follows, in seconds:

Full length waveforms: 7, 14, 21, 28, 56

Short-format waveforms: 3.5, 7, 14, 21, 28, 56

Volume ¹ (V) (ml) / time (s)	0 to 3200	0 to 3200	0 to 5, 0 to 10, 0 to 25, 0 to 50 (<i>neo default</i>), 0 to 100, 0 to 200, 0 to 400, 0 to 800 (<i>adult/ped default</i>), 0 to 1600, 0 to 3200
Flow ¹ (l/min) / time (s)	-300 to 300	-300 to 300	±2.5, ±5, ±10 (<i>neo default</i>), ±15, ±25, ±45, ±75 (<i>adult/ped default</i>), ±150, ±300
Airway pressure (Paw) (cmH ₂ O) / time (s)	-10 to 80	-10 to 80	-10/20, -10/40 (<i>default</i>), -10/80
FetCO ₂ ² (%) / time (s)	0 to 10	0 to 10	0 to 6 (<i>default</i>), 0 to 10

Table A-8 Real-time waveforms and loops (continued)

Parameter	Range		Y-axis scale
	Adult/Ped	Neonatal 	
PetCO ₂ ² / time (s) (mmHg)	0 to 100	0 to 100	0 to 60 (<i>default</i>), 0 to 100
(kPa)	0 to 14	0 to 14	0 to 8 (<i>default</i>), 0 to 14
Ptrachea ³ (cmH ₂ O) / time (s)	-10 to 100	-10 to 100	-10/20, -10/40, -10/80, -10/ 100
ASV graphs			
ASV target graph- ics: Tidal volume (Vt) (ml) / time (s)	0 to 3200	0 to 3200	0 to 5, 0 to 10, 0 to 25, 0 to 50, 0 to 100, 0 to 200, 0 to 400, 0 to 800 (<i>default</i>), 0 to 1600, 0 to 3200
ASV target graph- ics: Tidal volume (Vt) (ml) / / rate (b/min)	0 to 60	0 to 60	0 to 60
Loops¹			
Pressure/Volume <i>x-axis: cmH₂O</i> <i>y-axis: ml</i>	x: -10 to 80	x: -10 to 80	--
	y: 0 to 3200	y: 0 to 3200	--
Volume/Flow <i>x-axis: ml</i> <i>y-axis: l/min</i>	x: 0 to 3200	x: 0 to 3200	--
	y: -300 to 300	y: -300 to 300	--
Pressure/Flow <i>x-axis: cmH₂O</i> <i>y-axis: l/min</i>	x: -10 to 80	x: -10 to 80	--
	y: -300 to 300	y: -300 to 300	--
Volume/PCO ₂ <i>x-axis: ml</i> <i>y-axis: mmHg</i>	x: 0 to 3200	x: 0 to 3200	--
	y: 0 to 100	y: 0 to 100	--
Volume/FCO ₂ <i>x-axis: ml</i> <i>y-axis: %</i>	x: 0 to 3200	x: 0 to 3200	--
	y: 0 to 10	y: 0 to 10	--

1. Scaled automatically. Not leak compensated.
2. Available with CO₂ option.
3. Shown together with the pressure/time waveform in the same window (different color waveform). Only active when TRC is enabled.

A.7 Alarms

Table A-9 provides details about the adjustable alarms, including priority, upper and lower limit range, and default settings.

For additional details about alarms, see Chapter 4 and Chapter 8.

Table A-9 Adjustable alarm priority, range, defaults, and resolution



Alarm (units)	Priority	Range		Default setting		Resolution
		Adult/Ped	Neo 	Adult/Ped	Neo 	
Apnea time ¹ (s)	Adult: High Neonatal: Medium	15 to 60	in nCPAP-PS: 5 to 60/ OFF all other modes: 5 to 60	20	15	Adult: 5 s Neonatal: 1 < 15 s 5 ≥ 15
ExpMinVol, high ² (l/min)	High	in NIV, NIV-ST: 0.1 to 50/OFF other modes: 0.1 to 50	0.03 to 10/OFF	Based on Rate and Vt $1.5 * Rate * Vt$	Based on Rate and Vt $1.5 * Rate * Vt$	Adult: 0.1 < 1 0.5 ≥ 1 1 ≥ 10 Neo: 0.01 < 1 0.1 ≥ 1
ExpMinVol, low ² (l/min)	High	in NIV, NIV-ST: OFF/0.1 to 50 other modes: 0.1 to 50	OFF/ 0.01 to 10	Based on Rate and Vt $0.6 * Rate * Vt$	Based on Rate and Vt $0.6 * Rate * Vt$	Adult: 0.1 < 1 0.5 ≥ 1 1 ≥ 10 Neo: 0.01 < 1 0.1 ≥ 1
fTotal, high (b/min)	Medium	0 to 99	2 to 210	40	70	1
fTotal, low (b/min)	Medium	0 to 99	0 to 200	0	0	1
Oxygen, high ^{3,4} (%)	High	18 to 105	18 to 105	55	55	1
Oxygen, low ^{3,4} (%)	High	18 to 97	18 to 97	45	45	1

Table A-9 Adjustable alarm priority, range, defaults, and resolution





Alarm (units)	Priority	Range		Default setting		Resolution
		Adult/Ped	Neo 	Adult/Ped	Neo 	
PetCO ₂ , high ⁵ (mmHg) (kPa)	Medium	1 to 100 0.2 to 13.2	1 to 100 0.2 to 13.2	60 8	60 8	1 0.1
PetCO ₂ , low ⁵ (mmHg) (kPa)	Medium	OFF/0 to 100 OFF/0 to 13.2	OFF/0 to 100 OFF/0 to 13.2	30 4	30 4	1 0.1
Pressure, high (Pmax) (cmH ₂ O)	High	15 to 70	15 to 70	40	40	1
Pressure, low (cmH ₂ O)	High	4 to 60	<i>nCPAP-PS:</i> 2 to 60 <i>other modes:</i> 4 to 60	PEEP	<i>nCPAP-PS:</i> 2 <i>other modes:</i> PEEP	1
Pressure limitation (cmH ₂ O) ⁶	Medium; Low after silence	5 to 60	5 to 60	Pmax - 10	Pmax - 10	1
V _t , high ⁷ (ml)	Medium	10 to 3000/ OFF	0.1 to 300/OFF	V _t is based on IBW $1.5 * V_t$	V _t is based on Weight $1.5 * V_t$	<i>Adult:</i> OFF 5 < 100 ml 10 ≥ 100 and < 500 50 ≥ 500 <i>Neo:</i> OFF 0.1 < 10 1 ≥ 10 and < 100 5 ≥ 100

Table A-9 Adjustable alarm priority, range, defaults, and resolution

Alarm (units)	Priority	Range		Default setting		Resolution
		Adult/Ped	Neo 	Adult/Ped	Neo 	
Vt, low ⁷ (ml)	Medium	OFF/10 to 3000	OFF/0.1 to 300	Based on IBW $0.5 * Vt$	Based on Weight $0.5 * Vt$	<i>Adult:</i> OFF $5 < 100$ ml $10 \geq 100$ and < 500 $50 \geq 500$ <i>Neo:</i> OFF $0.1 < 10$ $1 \geq 10$ and < 100 $5 \geq 100$

1. The default setting is configurable.
2. Startup setting derived from body weight setting (neonates), IBW (adults/pediatrics).
3. Active only when O2 monitoring (O2 sensor) is enabled.
4. The high and low oxygen alarm limits are automatically set in relation to the current oxygen setting if high pressure O2 source is activated: O2 setting + 5 (Oxygen high limit) and O2 setting - 5 (Oxygen low setting). For example, if the Oxygen setting is 70%, the Oxygen high limit is set to 75 and the low limit is set to 65.
5. Requires CO2 option.
6. Adjustable with PsvLimit. Pressure limitation is always 10 below the pressure high limit.
7. In ASV mode, this alarm only applies for spontaneous breaths.

A.8 Configuration specifications

The following table lists the parameters and settings that can be specified in the Configuration windows. For details, see Appendix I.

Table A-10 Configuration specifications

Parameter	Configuration range	Default setting
General		
Language	English, Chinese, Croatian, Czech, Danish, Dutch, Finnish, French, German, Greek, Hungarian, Indonesian, Italian, Japanese, Korean, Norwegian, Polish, Portuguese, Romanian, Russian, Serbian, Slovak, Spanish, Swedish, Turkish	English
Units	Pressure: hPa, mbar, cmH2O CO2: mmHg, Torr, kPa Length: cm, inch	cmH2O mmHg cm
More	RS232 protocol: Hamilton, Galileo compatible, Hamilton P2, Philips Open VUELink, DrägerTestProtocol, Hamilton Block Protocol	Galileo
	Min. loudness (Factory setting = 1)	1
Modes		
Philosophy	<i>PCV+</i> , <i>APVcmv</i> , <i>(S)CMV</i> , <i>SIMV</i> : I:E/Pause, Tl/Pause, Peak flow/Tip <i>Mode label</i> : <i>APVcmv</i> / <i>APVsimv</i> , <i>(S)CMV+</i> / <i>SIMV+</i> <i>ASV</i> : <i>ASV</i> , <i>ASV 1.1</i>	I:E/Pause <i>APVcmv</i> / <i>APVsimv</i> <i>ASV 1.1</i>

Table A-10 Configuration specifications (continued)

Parameter	Configuration range	Default setting
Graphics		
Main Monitoring Parameters (MMP) ¹	MMP 1 to 5: Pmean, PEEP/CPAP, Ppeak, ExpMinVol, VTI, VTE, VLeak, fTotal, fSpont, Oxygen, Cstat, Rinsp, I:E, TI, TE, MVSpont, AutoPEEP, PO. 1, PTP, RCexp, Pplateau, VTESpont, MVLeak, InspFlow, ExpFlow, VT/IBW, VT/Weight	Ppeak ² , ExpMinVol, VTE, fTotal, I:E
Settings	For all mode, control, and alarm settings, see the appropriate tables in this appendix.	
Setups	This menu applies to the default adult Quick setup configurations. You can also specify default neonatal settings.	
Mode Ctrl		
	Vt/IBW: 5 to 12 ml/kg Vt/Weight (Neo): 5 to 12 ml/kg	Adult: 8 ml/kg Neonatal: 5 ml/kg
Vent Status		
Oxygen ³ (%)	22 to 80	40
PEEP ⁴ (cmH2O)	1 to 20	8
Pinsp (cmH2O)	1 to 50	10
%MinVol high (%)	100 to 250	150
%MinVol low (%)	25 to 99	50
RSB high (1/(l*min))	50 to 150	100
RSB low (1/(l*min))	0 to 49	10
%fSpont ⁵ (%)	0 to 99	75
Transfer	Export / Import	--
CO2 and SpO2 options	Software: Add / Clear Hardware: Activate / Deactivate	--

1. Additional parameters available when the CO2 or SpO2 options are installed.
2. The default setting is configurable. However, Ppeak is always set as an MMP.
3. The low Oxygen setting is always 21%.
4. The low PEEP setting is always 0 cmH2O.
5. The high %fSpont setting is always 100%.

A.9 Ventilator breathing system specifications

Table A-11 lists specifications for the HAMILTON-C3 ventilator breathing system.

Table A-11 Ventilator breathing system specifications

Parameter	Specification
Resistance ¹	Adult circuit (22 mm ID, flow of 30 l/min): Inspiratory limb: < 0.06 cmH ₂ O/30 l/min Expiratory limb: < 0.06 cmH ₂ O/30 l/min Pediatric circuit (15 mm ID, flow of 15 l/min): Inspiratory limb: < 0.12cmH ₂ O/15 l/min Expiratory limb: < 0.12 cmH ₂ O/15 l/min Coaxial circuit (flow of 30 l/min): Inspiratory limb: < 0.06 cmH ₂ O/30 l/min Expiratory limb: < 0.06 cmH ₂ O/30 l/min Neonatal circuit (12 mm ID, flow of 2.5 l/min): Inspiratory limb: < 0.74 cmH ₂ O/2.5 l/min Expiratory limb: < 0.74 cmH ₂ O/2.5 l/min
Compliance ¹	Adult circuit (22 mm ID): Approximately 2 ml/cmH ₂ O Pediatric circuit (15 mm ID): Approximately 1.5 ml/cmH ₂ O Coaxial circuit: Approximately 2.5 ml/cmH ₂ O Neonatal circuit (12 mm ID): Approximately 0.8 ml/cmH ₂ O
Volume ¹	Adult circuit (22 mm ID): Approximately 127 ml Pediatric circuit (15 mm ID): Approximately 75 ml Coaxial circuit: Approximately 150 ml Adult/Pediatric Flow sensor: 9 ml (single use), 11 ml (reusable) Neonatal circuit (12 mm ID): Approximately 45 ml Neonatal Flow sensor: Approximately 1.3 ml
Bacteria filter	Particle size: Captures particles of 0.3 mm (micron) with > 99.99% efficiency Resistance: < 1.3 cmH ₂ O at 20 l/min
Flow sensor dead space	Adult: Single use, < 9 ml; Reusable, < 11 ml Neonatal: < 1.3 ml

- As tested, the inspiratory limb includes ambient valve, flow sensor, inspiratory filter, inspiratory tubes, and humidifier. It does not include the heating wire. The expiratory limb includes expiratory tubes, water trap, expiratory valve, and flow sensor.

A.10 Technical performance data

Table A-12 lists technical performance data for the ventilator.

Table A-12 Technical performance data

Description	Specification
Patient ideal body weight (IBW, determined from Pat. height setting)	3 to 139 kg (6.6 to 306 lb) ¹
 Weight (used for neonatal patients)	0.2 to 30 kg (0.44 to 66 lb)
Inspiratory pressure	0 to 60 cmH ₂ O
Maximum limited pressure	70 cmH ₂ O
Maximum working pressure	0 to 60 cmH ₂ O (a combination of PEEP/CPAP and P _{insp}). Ensured through pressure limiting.
Maximum inspiratory flow	240 l/min (150 l/min with 100% O ₂)
Tidal volume/target tidal volume	Adults/ped: 20 to 2000 ml Neonatal: 2 to 300 ml
Minute volume capability	Up to 60 l/min
Inspiratory time (spontaneous breaths)	0.2 to 3 s
Minimum expiratory time	20% of cycle time; 0.2 to 0.8 s
Inspiratory valve response time	< 13 ms
Automatic expiratory base flow	Fixed at 6 l/min
Means of inspiratory triggering	Flow (flow trigger control setting) and pressure (pressure trigger control setting)
Oxygen mixer accuracy	± (volume fraction of 2.5% + 2.5% of actual reading)
O ₂ input flow	80 l/min (at 2.8 bar/ 280 kPa / 41 psi input pressure)

Table A-12 Technical performance data (continued)

Description	Specification
Measuring devices	Continuous oxygen measurement. The delivered oxygen concentration is continuously measured when the oxygen cell is enabled. Type: Galvanic cell Sensing position: Inspiratory pneumatics Measurement: Delivered oxygen concentration, range: 18% to 105% Response time: < 45 s to reach 90% of final oxygen concentration Initialization time (time from turning device on until operating performance): < 40 s Drift: $\leq 2.5\%$ at 60% Oxygen over 6 h To maximize the shelf life of unused O ₂ cells, Hamilton Medical recommends storing them at between 5°C and 15°C (41°F and 59°F) in a refrigerator.
	Pressure and volume measurements Type: Differential pressure transducer, variable orifice Sensing position: Patient y-piece Measurements: See Table A-9
Measuring devices	CO ₂ measurement Type: Nondispersive infrared (NDIR) technology Sensing position: Mainstream Measurements: See Table A-9 Rise time: < 60 ms Initialization time: Capnogram displayed in < 15 s at an ambient temperature of 25°C, full specifications within 2 min Sampling frequency: 100 Hz CO ₂ calculation method: BTPS CO ₂ stability: Short-term drift: ≤ 0.8 mmHg (0.10 kPa) over 4 h Long-term drift: Accuracy specification maintained over 120 h CO ₂ noise (rms): ≤ 0.25 mmHg (0.03 kPa) at 7.5% CO ₂
	Time measurements Type: Microprocessor Sensing position: Inside ventilator Measurements: See Table A-9
Tests and special functions	Tightness test, flow sensor/O ₂ cell/CO ₂ sensor calibration, O ₂ enrichment, manual breath, inspiratory hold maneuver, nebulization (30 min, 8 l/min), leak compensation, communication interface, compensation of breathing circuit resistance and compliance.

Table A-12 Technical performance data (continued)

Description	Specification
Display device	Display of settings, alarms, and monitored data: Type: TFT color Size: 1280 x 800 pixels, 12.1 in (307.3 mm) diagonal
Brightness setting for display	The range is 10% to 100% brightness. By default, Day is set to 80%; Night is set to 40%.
Alarm volume (Loudness ²)	The range is 1 to 10. The default for adults is 5, for neonates, 3.
Sound power level ³	51 dB(A) ±3 dB(A)
Sound pressure level ³	43 dB(A) ±3 dB(A)

1. Actual patient weight can be much greater (e.g., 300 kg or 661 lb)
2. Volume at 1 m distance from ventilator. A setting of 1 = 60 dB(A), 5 = 70 dB(A), and 10 = 83dB(A), with accuracy of ±3 dB(A).
3. Per ISO 80601-2-12

A.10.1 Accuracy testing

The ventilator’s parameter and measurement accuracy is tested using an IMT FlowAnalyser™. The tolerance intervals for the data generated by the FlowAnalyser are as specified below, and are included in the accuracy information provided in this manual.

Table A-13 Tolerance intervals for accuracy testing

Parameter type	Tolerance interval of measurement
Volume	≤ 50 ml: ±1% > 50 ml: ±1.75%
Pressure	±0.5% or ±0.1 cmH2O, whichever is greater
Flow	±1.75% or ±0.5 l/min, whichever is greater
O2	±1%

A.10.2 Essential performance

Table A-14 Essential performance

Component	Requirement
Gas supply failure	Gas supply failure must be detected and the operator informed.
Oxygen level alarm condition	If O2 is higher or lower than the set alarm limits, this must be detected and the operator informed through an alarm.
CO2 level alarm condition ¹	If CO2 is higher or lower than the set alarm limits, this must be detected and the operator informed through an alarm.
SPO2 level alarm condition ¹	If SpO2 is higher or lower than the set alarm limits, this must be detected and the operator informed through an alarm.

Table A-14 Essential performance

Component	Requirement
Pressure	The airway pressure must be monitored. If it is higher or lower than the set alarm limits, this must be detected and the operator informed through an alarm.
Volume	The applied and expired volumes must be monitored. If they are higher or lower than the set alarm limits, this must be detected and the operator informed through an alarm.
Electrical supply failure	An electrical supply failure must be detected and the operator informed.
Internal electrical power source nears depletion	The remaining battery capacity must be monitored and qualitatively indicated. At last 5 min prior to depletion, an alarm must be issued.

1. If option is installed.

A.11 Standards and approvals

NOTICE

Where standards are mentioned, the HAMILTON-C3 complies with the versions listed in Table 1 on page 8.

The HAMILTON-C3 was developed in accordance with pertinent international standards and FDA guidelines.

The ventilator is manufactured within an EN ISO 13485 and EN ISO 9001, Council Directive 93/42/EEC, Annex II, Article 3 certified quality management system.

The ventilator meets the Essential Requirements of Council Directive 93/42/EEC, Annex I.

The ventilator meets relevant parts of the following standards:

- **IEC 60601-1:** Medical electrical equipment, Part 1: General requirements for basic safety and essential performance. The device classification is: Class II, Type B applied part (ventilator breathing system, VBS), type BF applied part (CO2 sensor including CO2 module connector), continuous operation
- **IEC 60601-1-2:** Medical electrical equipment - Part 1-2: General requirements for basic safety and essential performance.
 - Collateral standard: Electromagnetic compatibility
 - Requirements and tests
- **ISO 80601-2-12:** Medical electrical equipment - Part 2-12: Particular requirements for the basic safety and essential performance of critical care ventilators
- **CAN/CSA-C22.2 No. 601.1:** Medical electrical equipment: General requirements for safety
- **ANSI/AAMI 60601-1:** Medical electrical equipment - Part 1: General requirements for basic safety and essential performance
- **EN ISO 5356-1:** Anaesthetic and respiratory equipment - conical connectors - Part 1: Cones and sockets
- **EN ISO 5359:** Low-pressure hose assemblies for use with medical gases
- **EN ISO 80601-2-55:** Medical electrical equipment - Part 2-55: Particular requirements for the basic safety and essential performance of respiratory gas monitoring

A.12 Warranty

LIMITED WARRANTY

THE WARRANTY DESCRIBED IN THIS AGREEMENT IS IN LIEU OF ANY AND ALL OTHER WARRANTIES, EXPRESS OR IMPLIED, INCLUDING IMPLIED WARRANTIES OF MERCHANTABILITY AND FITNESS FOR A PARTICULAR PURPOSE. HOWEVER, IMPLIED WARRANTIES ARE NOT DISCLAIMED DURING THE PERIOD OF THIS LIMITED WARRANTY.

Hamilton Medical guarantees its products to be shipped free from defects in material and workmanship.

The warranty does not include disposable items. Disposable items and consumable products are considered to be of single use or of limited use only and must be replaced regularly as required for proper operation of the product following the operator's manual.

Hamilton Medical and the manufacturer shall have no obligations nor liabilities in connection with the product other than what is specified herein, including without limitation, obligations and/ or liabilities for alleged negligence, or for strict liability.

In no event shall the company be liable for incidental or consequential damages, either direct or contingent.

This Limited Warranty shall be void and not apply:

1. If the product has not been installed and connected by an authorized local representative of Hamilton Medical in accordance with the instructions furnished by Hamilton Medical and by a Hamilton Medical representative.
2. If replacements and/or repairs have not been performed by authorized or properly trained personnel.

3. If no evidence is present that the occurrence of damage/ repair happened within the certified warranty period.
4. If the serial number has been altered, effaced or removed and there is no bill of sale or evidence to verify the product's purchase date.
5. If the defects arise from misuse, negligence, or accidents or from repair, adjustment, modification or replacement made outside Hamilton Medical's factories or other than an authorized service center or authorized service representative.
6. If the product has been modified, or in any nature altered without prior written authorization from Hamilton Medical.
7. If yearly maintenance is not performed.
8. If the product is or has been used in any way that is not specified under "Intended Use" (see "General cautions and notes").
9. If the product has been used by anyone, but properly trained personnel under the supervision of a physician. Replacements and/or repairs furnished under this Limited Warranty do not carry a new warranty, but carry only the unexpired portion of the original Limited Warranty. The warranty of repaired and/or replaced components does not exceed the Limited Warranty of the device.

To obtain service under this Limited Warranty, claimant must promptly notify the country's sales partner of Hamilton Medical regarding the nature of the problem, serial number and the date of purchase of the Product.

Except as stated above, Hamilton Medical shall not be liable for any damages, claims or liabilities including, but not limited to, personal bodily injury, or incidental, consequential, or special damages. Nor will Hamilton Medical be liable for any damages, claims or liabilities including, but not limited to, personal bodily injury, or incidental, consequential, or special damages resulting from misuse of the device or failure to comply with any of the provisions made in this manual.

A.13 Miscellaneous

The general terms and conditions of Hamilton Medical shall be applicable. This agreement shall be governed by and construed in accordance with the laws of Switzerland and may be enforced by either party under the jurisdiction of the court of Chur, Switzerland.

B

Ventilation modes

B.1	Overview	238
B.2	The aims of ventilation	239
B.3	Ventilation modes	239
B.4	(S)CMV mode	243
B.5	APVcmv / (S)CMV+ mode	246
B.6	SIMV mode	248
B.7	APVsimv / SIMV+ mode	250
B.8	PCV+ mode	252
B.9	PSIMV+ mode	254
B.10	PSIMV+ mode with PSync	256
B.11	DuoPAP mode	258
B.12	APRV mode	260
B.13	SPONT and NIV modes	262
B.14	NIV-ST mode	264
B.15	nCPAP-PS mode	266
B.16	High flow oxygen therapy (HiFlowO2)	268
B.17	ASV mode	270
B.18	INTELLiVENT-ASV mode	272
B.19	Safety mode/therapy	273

B.1 Overview

The HAMILTON-C3 has a full range of ventilation modes that provide full and partial ventilatory support.

Table B-1 outlines ventilation terminology and definitions used in this manual.

Table B-1 Ventilation mode terminology

Breath types	Hamilton Medical ventilators support two main breathing methods, mandatory breathing and spontaneous breathing.	
	Mandatory breath	The start of inspiration (triggering) is determined by the ventilator or the patient. The end of inspiration (cycling) is determined by the ventilator.
	Spontaneous breath	The start of inspiration (triggering) and end of inspiration (cycling) is determined by the patient. The patient breathes independently or receives support from the ventilator.
Breath sequences	IMV	<i>Intermittent mandatory ventilation.</i> Spontaneous breaths are possible between mandatory breaths.
	CMV	<i>Continuous mandatory ventilation.</i> Every breath is mandatory.
	CSV	<i>Continuous spontaneous ventilation.</i> Every breath is spontaneous.
Control variables	PC	Pressure control
	VC	Volume control
Targeting scheme	Set point	Ventilation targets are set by the operator.
	Adaptive	Ventilator adjusts a target ventilation parameter with changing patient conditions.
	Optimum	The ventilator automatically adjusts one or more controls to reach the target set by the user, taking into account changing patient condition, less work of breathing, and trying to keep the pressure support as low as possible.
	Intelligent	The ventilator adjusts ventilation using intelligent tools. The ventilator automatically adjusts one or more controls to reach the targets adapted from the ventilator according to the set ventilation strategy and patient output.

B.2 The aims of ventilation

The primary aims of mechanical ventilation are:

- Elimination of CO₂
- Oxygenation
- Patient synchronization

The detailed mode descriptions provided in this chapter illustrate how the controls work to eliminate CO₂, and provide oxygenation and synchronization between the device and the patient.

B.3 Ventilation modes

NOTICE

- Some modes are available as options.
- Some modes may not be available in all markets.

The appropriate mode for each patient depends on their breathing effort: no patient inspiratory effort, increasing breathing effort, or breathing spontaneously.

A ventilation mode combines control type, breath sequence, and breath type.

The tables that follow provide the following overviews:

- Figure B-1 shows the available adult/pediatric ventilation modes.
- Figure B-2 shows the available neonatal ventilation modes.
- Table B-2 outlines the ventilation modes available on the HAMILTON-C3 ventilator.
- Table 4-2 in Chapter 4 provides a description of the control parameters

Figure B-1 Ventilation modes, adult/pediatric

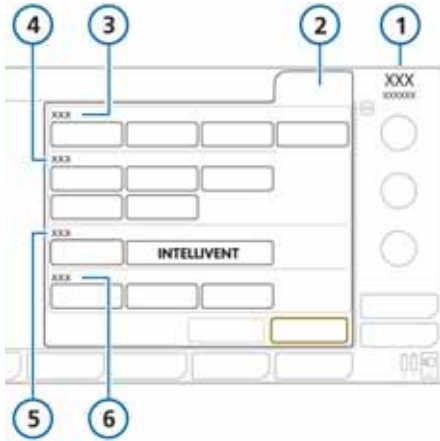

- 1 Current mode
- 2 Modes
- 3 Volume controlled modes
- 4 Pressure controlled modes
- 5 Intelligent ventilation modes
- 6 Noninvasive modes

Figure B-2 Ventilation modes, neonatal

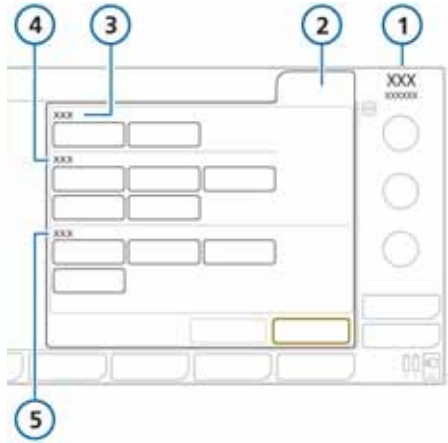



- 1 Current mode
- 2 Modes
- 3 Volume controlled modes
- 4 Pressure controlled modes
- 5 Noninvasive modes

Table B-2 HAMILTON-C3 ventilation modes

Mode name	Mode	Breath sequence	Apnea backup
Volume controlled modes, flow controlled			
(S)CMV	Adult/pediatric only. Breaths are volume controlled and mandatory, including patient triggered breaths.	VC-CMV	--
SIMV	Adult/pediatric only. A fixed rate is set for volume controlled mandatory breaths. Additional patient triggered breaths between mandatory breaths are spontaneous breaths (with or without pressure support).	VC-IMV	(S)CMV
Volume controlled modes, adaptive pressure			
APVcmv / (S)CMV+	Breaths are volume targeted and mandatory.	PC-CMV	--
APVsimv / SIMV+	Volume targeted mandatory breaths can be alternated with pressure supported spontaneous, SPONT, breaths.	PC-IMV	APVcmv

Table B-2 HAMILTON-C3 ventilation modes (continued)

Mode name	Mode	Breath sequence	Apnea backup
Pressure controlled modes			
PCV+	All breaths, whether triggered by either the patient or the ventilator, are pressure controlled and mandatory.	PC-CMV	--
PSIMV+	Mandatory breaths are pressure controlled. Mandatory breaths can be alternated with pressure supported spontaneous breaths.	PC-IMV	--
DuoPAP	Mandatory breaths are pressure controlled. Spontaneous breaths can be triggered at both pressure levels.	PC-IMV	APVcmv
APRV	Mandatory breaths are pressure controlled. Spontaneous breaths can be triggered at both pressure levels.	PC-APRV	APVcmv
SPONT	Every breath is spontaneous.	PC-CSV	APVcmv
Pressure controlled modes, noninvasive			
NIV	Every breath is spontaneous.	PC-CSV	PCV+
NIV-ST	Every breath is spontaneous as long as the patient is breathing above the set rate. A backup rate can be set for mandatory breaths.	PC-IMV	--
nCPAP-PS	Neonatal only. Every breath is spontaneous as long as the patient is breathing above the set rate. A backup rate can be set for mandatory breaths.	PC-IMV	--
Therapy, noninvasive			
HiFlowO2	High flow oxygen therapy. No supported breaths,.  WARNING! <i>Not available in the USA.</i>	n/a	--
Volume controlled modes, Intelligent ventilation			
ASV	Adult/pediatric only. Operator sets %MinVol, PEEP, and Oxygen. Frequency, tidal volume, pressure, and I:E ratio are based on physiological input from the patient.	PC-IMV	--
INTELLIVENT-ASV	<i>Adult/pediatric only. Fully automated management of ventilation and oxygenation based on physiological input from the patient. The underlying mode is ASV.</i>  WARNING! <i>Not available in the USA.</i>	PC-IMV	--

B.3.1 Breath timing options

The ventilator controls mandatory breath timing using a combination of inspiratory time (TI) and rate.

For two modes, PCV+ and APVcmv (or (S)CMV+), you can set the ventilator to use any of the following combinations to control breath timing:

- I:E/Pause
- TI/Pause
- Peak flow/Tip

To select breath timing for PCV+ and APVcmv ((S)CMV+) modes, see Section I.4.1.

B.4 (S)CMV mode

(S)CMV stands for *synchronized controlled mandatory ventilation*.

Breaths in (S)CMV mode are volume-controlled and mandatory.

If a breath is not triggered by patient effort within a preset time, the ventilator delivers a set tidal volume with a constant flow and operator selected flow pattern for a set inspiratory time at a set respiratory rate.

The ventilator always delivers the set tidal volume and pressure in the airway can increase or decrease depending on the resistance and compliance of the patient's lungs.

To protect the patient's lungs it is important to carefully set an upper pressure limit.

The tidal volume (V_t) setting defines the delivered volume. The **Rate** and **I:E** define the timing of the breath cycle.

Breaths can be triggered by the ventilator or the patient. In this mode, the operator sets the **V_t** , the **Rate** and the **FlowPattern**.

As in all other modes, the operator also sets the **PEEP/CPAP** and **Oxygen**, and the **pressure or flow trigger**.

The **Pause** setting (in %) is always set in relation to the total breath time.

Figure B-3 (S)CMV mode: Breathing pattern and controls

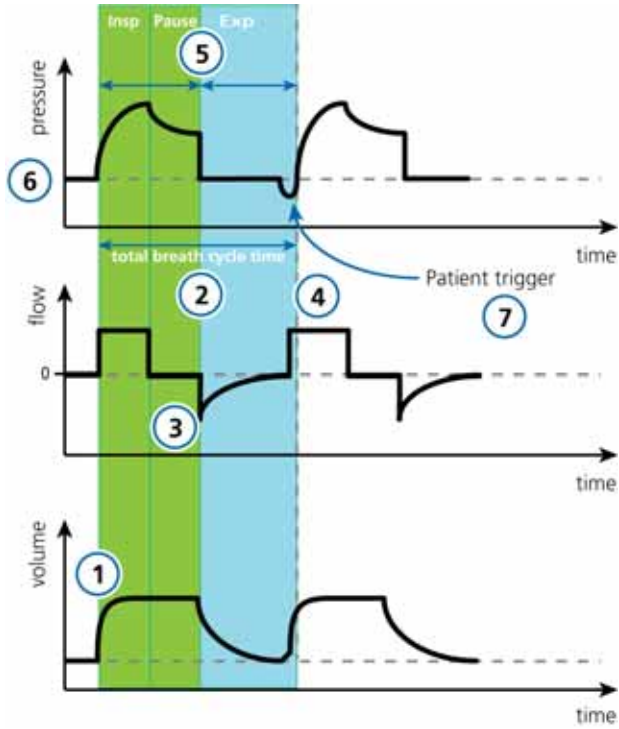

CO2 elimination

- 1 Vt
- 2 Rate
- 3 Pause
- Sigh (*not shown*)

Oxygenation

- 4 Flow pattern
- 5 I:E
- 6 PEEP
- Oxygen (*not shown*)

Patient synchronization

- 7 Trigger

B.5 APVcmv / (S)CMV+ mode

APVcmv stands for *adaptive pressure ventilation with controlled mandatory ventilation*.

This mode is also called (S)CMV+, which stands for *synchronized controlled mandatory ventilation*.

APVcmv is a volume targeted pressure regulated ventilation mode. It functions similarly to the conventional volume-controlled mode of ventilation, (S)CMV, except that pressure is the control variable rather than flow. Pressure is adapted between breaths to achieve the target tidal volume.

Breaths in APVcmv mode are volume-targeted and mandatory, delivered at the lowest possible pressure depending on lung conditions.

In the APVcmv version of this volume controlled mode, the operator sets the target tidal volume.

The ventilator delivers the set target volume (V_t) at a preset rate. The patient can trigger additional breaths between preset rate breaths.

Figure B-4 APVcmv / (S)CMV+ mode: Breathing pattern and controls

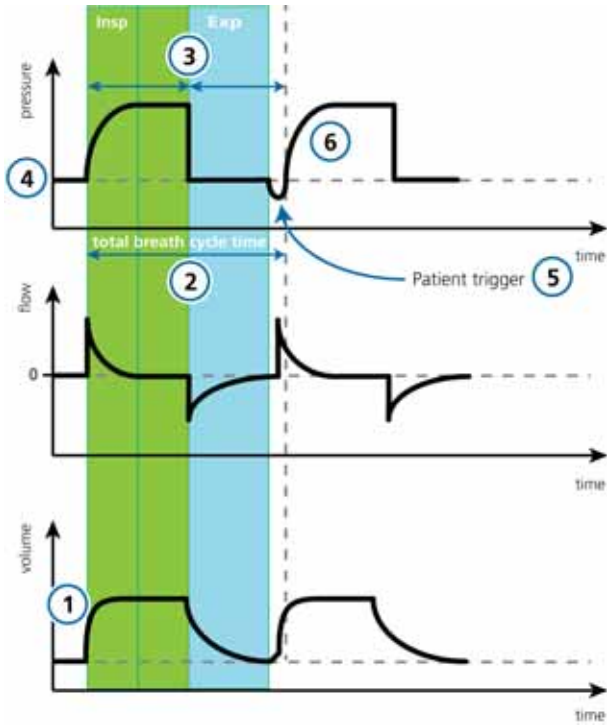
CO2 elimination

- 1 Vt
- 2 Rate
- Slgh (*not shown*)

Oxygenation

- 3 I:E
- 4 PEEP
- Oxygen (*not shown*)

Patient synchronization

- 5 Trigger
- 6 Pramp

B.6 SIMV mode

SIMV stands for *synchronized intermittent mandatory ventilation*.

In SIMV mode, the ventilator delivers volume controlled mandatory (S)CMV breaths, which can be alternated with pressure supported spontaneous, breaths.

After the mandatory breath is delivered, the patient is free to take any number of time-cycled breaths for the remainder of the SIMV breath interval.

SIMV mode guarantees volume delivery, with one or more breaths delivered within an interval determined by the operator-set Rate.

Each SIMV breath interval includes mandatory time (**T_{mand}**) and spontaneous time (**T_{spont}**).

During **T_{mand}**, the ventilator waits for the patient to trigger a breath.

If the patient triggers a breath, the ventilator immediately delivers a mandatory breath. All following breaths during **T_{spont}** will be flow-cycled, pressure supported.

If the patient does not trigger a breath, the ventilator automatically delivers a mandatory breath at the end of **T_{mand}**.

Figure B-5 **SIMV mode: Breathing pattern and controls**

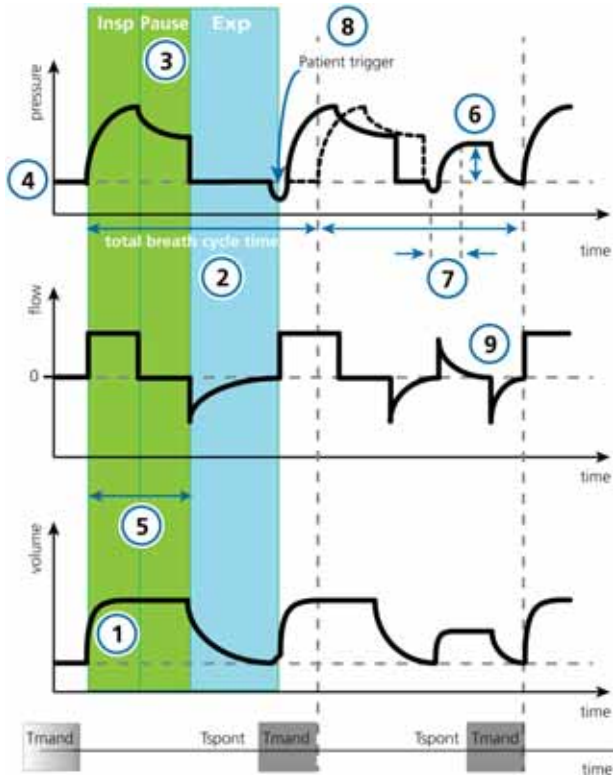

CO2 elimination

- 1 Vt
- 2 Rate
- 3 Pause
- Sigh (*not shown*)

Oxygenation

- 4 PEEP
- 5 TI
- 6 Psupport
- Oxygen (*not shown*)

Patient synchronization

- 7 P-ramp
- 8 Trigger
- 9 ETS

B.7 APVsimv / SIMV+ mode

APVsimv stands for *adaptive pressure ventilation with synchronized intermittent mandatory ventilation*.

This mode is also called SIMV+, which stands for *synchronized intermittent mandatory ventilation plus*.

The APVsimv mode combines attributes of the APVcmv and SPONT modes, delivering volume-targeted, time-cycled mandatory breaths and pressure-supported, patient triggered, flow-cycled spontaneous breaths.

As with APVcmv mode, APVsimv mode ensures that the set target volume is delivered during the mandatory breaths.

Each SIMV breath interval includes mandatory time (Tmand) and spontaneous time (Tspont).

During Tmand, the ventilator waits for the patient to trigger a breath.

If the patient triggers a breath, the ventilator immediately delivers a mandatory breath.

If the patient does not trigger a breath, the ventilator automatically delivers a mandatory breath at the end of Tmand.

In SIMV+ mode, parameters for both mandatory and spontaneous breath types are set.

- The tidal volume (Vt) defines the delivered volume of mandatory breaths.
- Rate and TI define the breath timing.
- For spontaneous breaths, the ETS setting defines the percentage of peak flow that cycles the ventilator into exhalation.

Breaths can be triggered by the ventilator and the patient.

Figure B-6 APVsimv / SIMV+ mode: Breathing pattern and controls

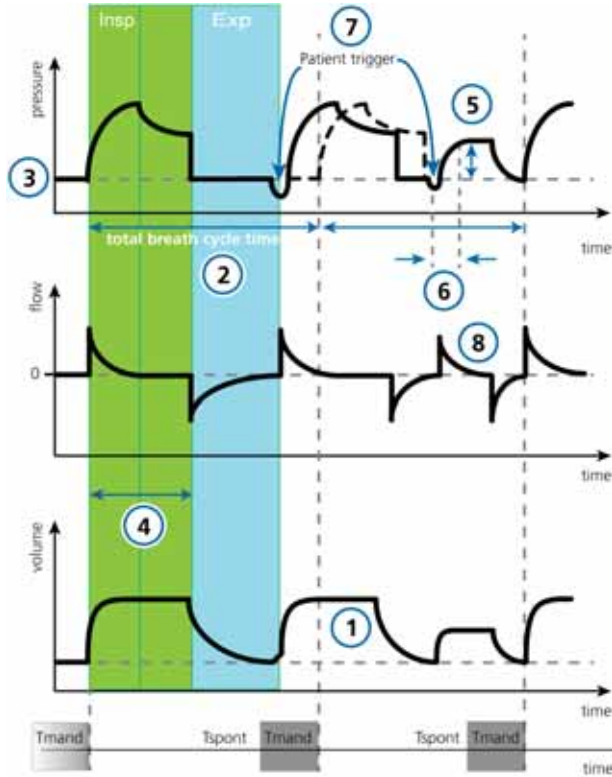

CO2 elimination

- 1 Vt
- 2 Rate
- Sigh (*not shown*)

Oxygenation

- 3 PEEP
- 4 TI
- 5 Psupport
- Oxygen (*not shown*)

Patient synchronization

- 6 P-ramp
- 7 Trigger
- 8 ETS

B.8 PCV+ mode

PCV+ stands for *pressure controlled ventilation*.

Breaths in PCV+ mode are pressure-controlled and mandatory.

The breath can be triggered by the ventilator or by the patient. If the breath is triggered by the patient, the inspiratory rate may increase.

The ventilator delivers a set pressure, within a set Pramp time, for a set inspiratory time at a set respiratory rate.

The ventilator delivers a constant level of pressure, so the volume will depend on the pressure settings, the inspiration time, and the resistance and compliance of the patient's lungs.

NOTICE

Ensure tidal volume and/or minute volume alarms are set.

The pressure control (Pcontrol) setting defines the applied pressure. The rate and breath timing settings (TI, I:E, Rate) define the timing of the breath cycle.

Figure B-7 PCV+ mode: Breathing pattern and controls

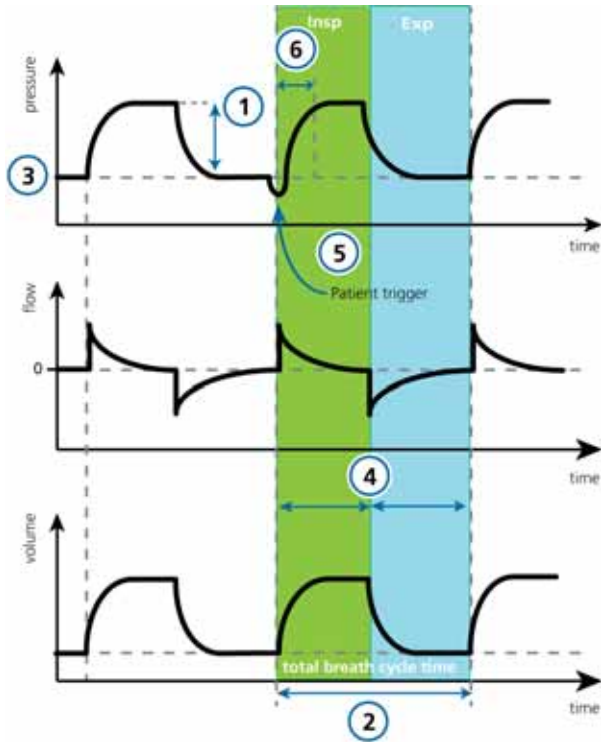
CO₂ elimination

- 1 Pcontrol
 - 2 Rate
- Sigh (*not shown*)

Oxygenation

- 3 PEEP/CPAP
 - 4 I:E^a
- Oxygen (*not shown*)

Patient synchronization

- 5 Trigger
- 6 P-ramp

a. Depends on timing philosophy (I:E or TI)

B.9 PSIMV+ mode

PSIMV+ stands for *pressure controlled synchronized intermittent mandatory ventilation*.

PSIMV+ mode has two options: with and without PSync. For a description of PSIMV+ with active PSync, see Section B.10.

In PSIMV+ mode, the mandatory breaths are PCV+ breaths. These can be alternated with spontaneous breaths.

The PSIMV+ mode does not guarantee the delivery of an adequate tidal volume at all times. When using this mode, carefully monitor changes in the patient's status.

Each SIMV breath interval includes mandatory time (T_{mand}) and spontaneous time (T_{spont}).

If the patient triggers during T_{spont}, the ventilator delivers a pressure supported breath.

During T_{mand}, the ventilator waits for the patient to trigger a breath. If the patient triggers a breath, the ventilator immediately delivers a mandatory breath.

If the patient does not trigger a breath, the ventilator automatically delivers a mandatory breath at the end of T_{mand}.

The PSIMV+ mode requires that you set the parameters needed for both mandatory and spontaneous breath types.

- The pressure control (**Pcontrol**) setting defines the applied pressure for mandatory breaths. The rate and breath timing settings (TI, I:E) define the timing of the breath cycle.
- The **Rate** and **TI** control settings define the breath timing.
- For spontaneous breaths, the expiratory trigger sensitivity (**ETS**) setting defines the percentage of peak flow that cycles the ventilator into exhalation. **Psupport** defines the pressure support above PEEP.

Figure B-8 PSIMV+ mode: Breathing pattern and controls

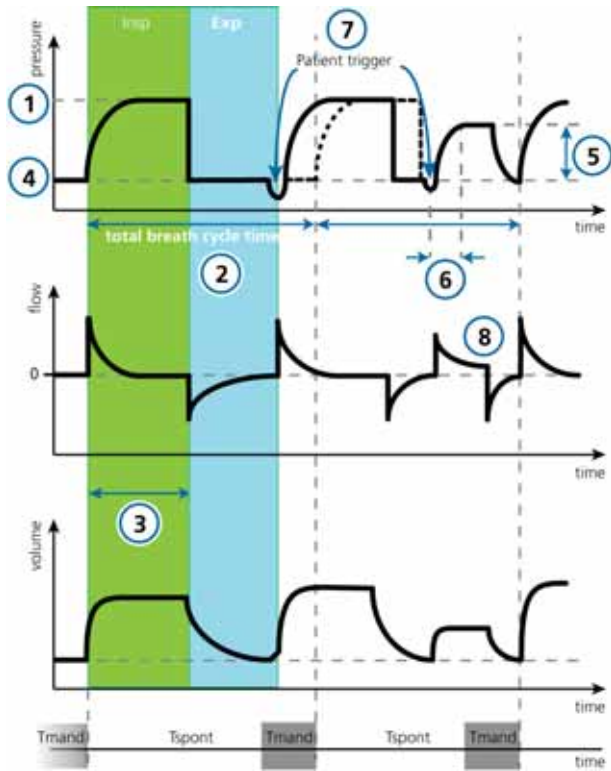

CO2 elimination

- 1 Pcontrol
- 2 Rate
Sigh (*not shown*)

Oxygenation

- 3 TI
- 4 PEEP/CPAP
- 5 Psupport
Oxygen (*not shown*)

Patient synchronization

- 6 P-ramp
- 7 Trigger
- 8 ETS

B.10 PSIMV+ mode with PSync

PSIMV+ stands for *pressure controlled synchronized intermittent mandatory ventilation*.

PSIMV+ mode has two options: with and without PSync. For a description of PSIMV+ without active PSync, see Section B.9.

The PSIMV+ mode with PSync does not guarantee the delivery of an adequate tidal volume at all times. When using this mode, carefully monitor changes in the patient's status.

Each SIMV breath interval includes mandatory time (T_{mand}) and spontaneous time (T_{spont}).

If the patient triggers during T_{spont} or T_{mand}, the ventilator delivers a breath supported at the P_{insp} setting.

If the patient does not trigger a breath, the ventilator automatically delivers a mandatory breath at the end of T_{mand}.

The pressure control (P_{insp}) setting defines the applied pressure for mandatory breaths. The rate and breath timing settings (T_I, I:E) define the timing of the breath cycle.

The Rate setting is a minimum rate guarantee. If the patient's spontaneous rate is equal to or greater than the set rate, then all breaths are spontaneous and supported at the P_{insp} setting. If the patient's rate falls below the rate setting, mandatory breaths at the P_{insp} setting and set Inspiratory time are delivered.

For patient triggered breaths, the expiratory trigger sensitivity (ETS) setting defines the percentage of peak flow that cycles the ventilator into exhalation.

Figure B-9 PSIMV+ with PSync mode: Breathing pattern and controls

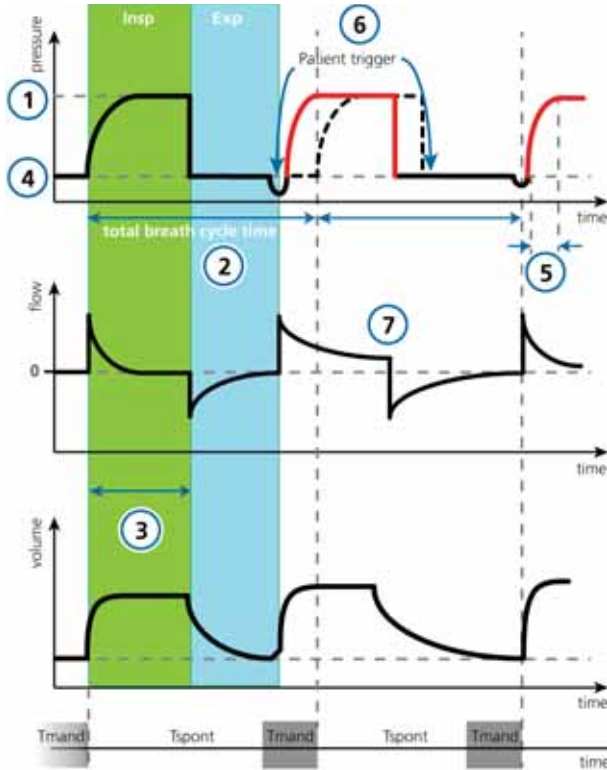
CO₂ elimination

- 1 P_{insp}
- 2 Rate
- Sigh (*not shown*)

Oxygenation

- 3 TI
- 4 PEEP/CPAP
- Oxygen (*not shown*)

Patient synchronization

- 5 P-ramp
- 6 Trigger
- 7 ETS

B.11 DuoPAP mode

DuoPAP stands for *duo positive airway pressure*.

DuoPAP is a type of pressure ventilation designed to support spontaneous breathing on two alternating levels of CPAP.

In this mode, the ventilator switches automatically and regularly between two operator-selected levels of positive airway pressure or CPAP.

The patient may breathe freely at either level. In DuoPAP, pressure support can be added to these spontaneous breaths. Cycling between the levels is triggered by DuoPAP timing settings or by patient effort.

In DuoPAP, the switch-over between the two levels is defined by pressure settings **P high** and **PEEP/CPAP** and time settings **T high** and **Rate**. Like **PEEP/CPAP**, **P high** is relative to atmospheric pressure.

With different patients and with different combinations of control settings, DuoPAP can be made to resemble a variety of conventional ventilation modes.

At conventional settings and in the absence of spontaneous breathing, DuoPAP resembles **PCV+**.

As you decrease the rate, keeping **T high** short relative to the time at the lower pressure level, the mode looks more like **PSIMV+**, with spontaneous breaths following mandatory breaths.

If **T high** is almost set to breath cycle time with just enough time at the low level to allow full or near-full exhalation, this mode looks like **APRV** (Airway pressure release ventilation).

Pressure support can be set to assist spontaneous breaths in DuoPAP, whether they occur at the **PEEP/CPAP** or **P high** level.

Psupport is set relative to (above) **PEEP/CPAP**. That means that spontaneous breaths at the **P high** level are supported only when this target pressure is greater than **P high**.

To easily adapt to the patient's spontaneous breathing pattern, the change-over from low to high pressure level and vice versa are synchronized with the patient's spontaneous breathing.

The frequency of the change-over is kept constant, even with patient synchronization, by defining a trigger time window with a fixed time constant.

Figure B-10 DuoPAP mode: Breathing pattern and controls

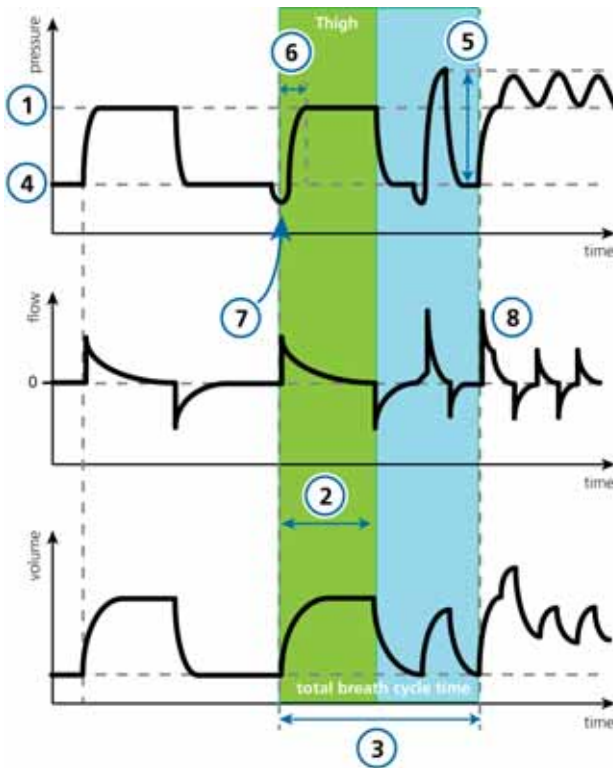
CO₂ elimination

- 1 P high
- 2 T high
- 3 Rate

Oxygenation

- 4 P low
- 5 P_{support}
- Oxygen (*not shown*)

Patient synchronization

- 6 P-ramp^a
- 7 Trigger
- 8 ETS

a. Pressure rise time to P high and P_{support}

B.12 APRV mode

APRV stands for *airway pressure release ventilation*.

APRV produces alveolar ventilation as an adjunct to CPAP.

Set airway pressure **P high** is transiently released to a lower level **P low**, after which it is quickly restored to reinflate the lungs.

For a patient who has no spontaneous breathing efforts, APRV is similar to pressure-controlled inverse ratio ventilation.

APRV allows spontaneous breathing at any time during the respiratory cycle.

Tidal volume (**Vt**) for APRV breath depends on lung compliance, respiratory resistance, the magnitude and duration of the pressure release (**T low** setting) and the magnitude of the patient’s spontaneous breathing efforts.

When switching to APRV the first time, the timing and pressure settings proposed are based on Table B-3.

Settings for **P high**, **T high**, and **T low** will be stored when switching to another mode, but recalled when returning to APRV. The initialization occurs as shown or last set value in APRV.

Table B-3 Default settings for APRV

IBW (kg)	P high / P low cmH2O	T high (s)	T low (s)
0.2 to 3	20 / 5	1.4	0.2
3 to 5	20 / 5	1.7	0.3
6 to 8	20 / 5	2.1	0.3
9 to 20	20 / 5	2.6	0.4
21 to 39	20 / 5	3.5	0.5
40 to 59	20 / 5	4.4	0.6
60 to 89	20 / 5	5.4	0.6
90 to 99	23 / 5	5.4	0.6
100	23 / 5	5.4	0.6

Figure B-11 APRV mode: Breathing pattern and controls

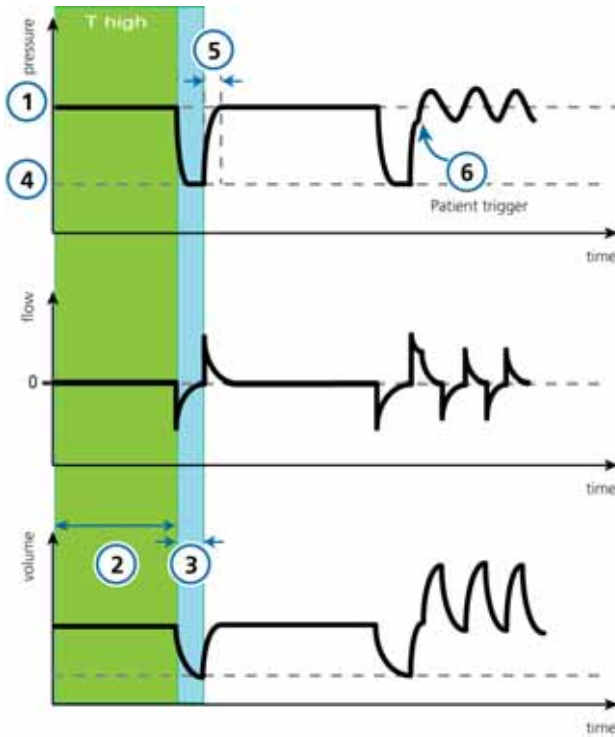
CO₂ elimination

- 1 P high^a
- 2 T high

Oxygenation

- 3 T low
 - 4 P low
- Oxygen (*not shown*)

Patient synchronization

- 5 P-ramp to P high
- 6 Trigger

- a. With prolonged T high settings and short T low settings, the P high setting in effect becomes the PEEP level.

B.13 SPONT and NIV modes

SPONT stands for *spontaneous mode*, NIV stands for *noninvasive ventilation*.

The spontaneous or pressure support modes, SPONT and NIV, deliver spontaneous breaths and operator-initiated manual, mandatory breaths.

SPONT is designed for an intubated patient, while NIV is designed for use with a mask or other noninvasive patient interface.

The patient's spontaneous breathing efforts are always supported with the set pressure support (**Psupport**).

When pressure support is set to zero, the ventilator functions like a conventional CPAP system.

- The pressure support (**Psupport**) setting defines the applied pressure during inspiration.
- The patient determines the breath timing.
- The PEEP setting defines the PEEP/CPAP applied during expiration (and inspiration if **Psupport** is set to zero).

Figure B-12 SPONT/NIV modes: Breathing pattern and controls

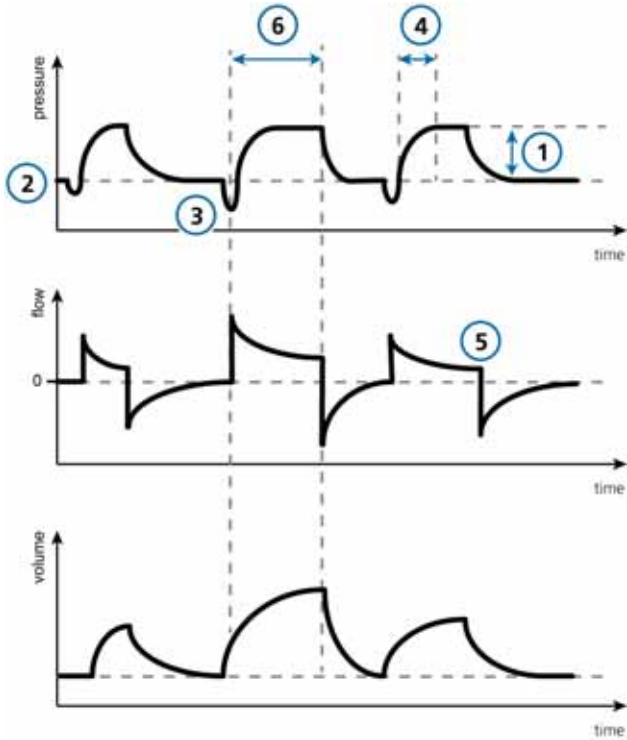
CO2 elimination

- 1 Psupport
- Sigh (*not shown*)

Oxygenation

- 2 PEEP/CPAP
- Oxygen (*not shown*)

Patient synchronization

- 3 Trigger
- 4 P-ramp
- 5 ETS
- 6 TI max

B.14 NIV-ST mode

NIV-ST stands for *spontaneous/timed noninvasive ventilation*.

NIV-ST mode delivers time-cycled or flow-cycled breaths. Every patient effort results in a flow-cycled, pressure supported breath.

If the patient rate falls below the set mandatory **Rate**, time-cycled breaths will be delivered at set **Rate** and timing.

NIV-ST, like NIV, is designed for use with a mask or other noninvasive patient interface.

As with the PCV+ mode, NIV-ST delivers a preset pressure, but does not guarantee a fixed tidal volume, especially during changes in respiratory system compliance, airway resistance, AutoPEEP, or the patient's respiratory activity.

If the patient triggers a breath during the breath interval **timv**, the ventilator immediately delivers a spontaneous breath. If the patient does not trigger an inspiration during this time, the ventilator initiates a mandatory breath at the end of **timv**.

You must set the parameters needed for both mandatory and spontaneous breath types.

- The inspiratory pressure (**P_{insp}**) setting defines the applied pressure for both mandatory and spontaneous breaths.
- The **Rate** and **TI** (inspiratory time) control settings define the breath timing.
- For spontaneous breaths, the expiratory trigger sensitivity (**ETS**) setting defines the percentage of peak flow that cycles the HAMILTON-C3 into exhalation.

Figure B-13 NIV-ST mode: Breathing pattern and controls

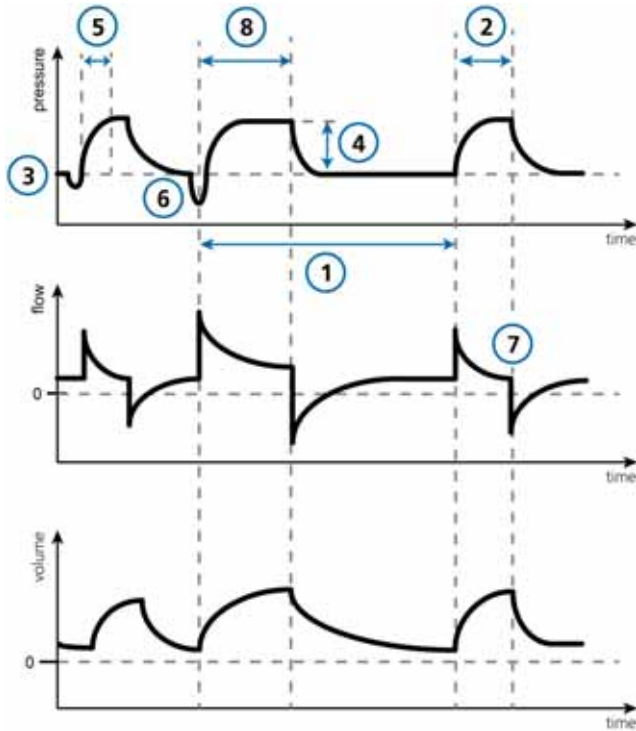
CO2 elimination

1 Rate

Oxygenation

2 TI

3 PEEP/CPAP

 Oxygen (*not shown*)

Patient synchronization

 4 P_{support}

5 P-ramp

6 Trigger

7 ETS

8 TI max

B.15 nCPAP-PS mode

nCPAP-PS stands for *nasal continuous Positive airway pressure*.

nCPAP-PS is a neonatal mode that offers nasal continuous positive airway pressure - and intermittent positive pressure support through a nasal interface (mask or prongs) for infants and neonates. It is designed to apply CPAP using a nasal interface (mask or prongs).

Psupport can also be set to zero. When **Psupport** is set to zero, the minimum PEEP setting is 2 cmH₂O. Ventilation is performed by the patient by inhalation and exhalation from the base flow.

As with the PSIMV mode, nCPAP-PS delivers a preset **Psupport** pressure, but does not guarantee a fixed tidal volume, especially during changes in respiratory system compliance, airway resistance, AutoPEEP, or the patient's respiratory activity.

If the patient triggers a breath during the breath interval **timv**, the ventilator immediately delivers a spontaneous breath. If the patient does not trigger an inspiration during this time, the ventilator initiates a mandatory breath at the end of **timv**.

This mode requires that you set the parameters needed for both mandatory and spontaneous breath types.

The inspiratory pressure (**Pinsp**) setting defines the applied pressure for both mandatory and spontaneous breaths. The **Rate** and **TI** (inspiratory time) control settings define the breath timing. For spontaneous breaths, the **ETS** setting defines the percentage of peak flow that cycles the device into exhalation.

B.15.1 Contraindications for use

nCPAP -PS is contraindicated for the following physiologic conditions:

- Respiratory failure defined as pH < 7.25, PCO₂ > 60
- Congenital malformations of the upper airway (T-E fistula, choanal atresia, cleft palate)
- Congenital diaphragmatic hernia, bowel obstruction, oomphalocele, or gastroschisis
- Severe cardiovascular instability
- Poor respiratory drive

Figure B-14 nCPAP-PS mode: Breathing pattern and controls

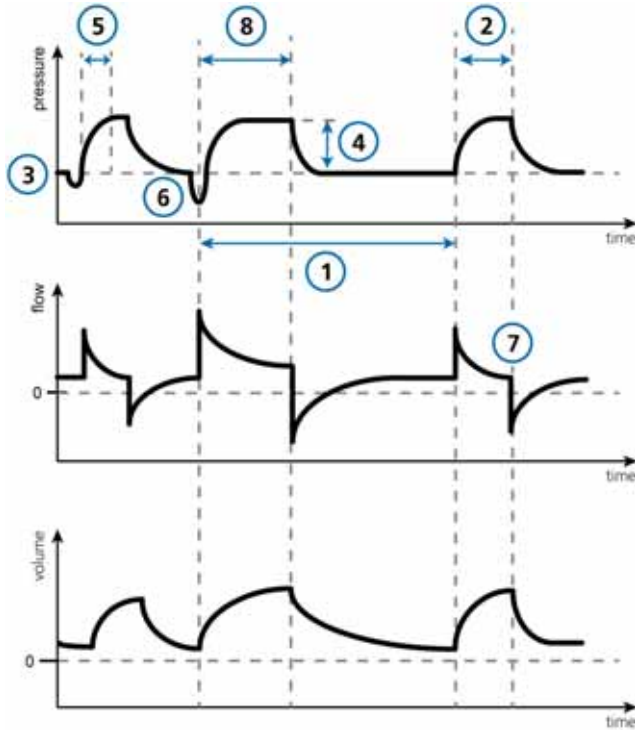
CO2 elimination

1 Rate

Oxygenation

 2 TI
 3 PEEP/CPAP
 4 Psupport
 Oxygen (not shown)

Patient synchronization

 5 P-ramp
 6 Trigger
 7 ETS
 8 TI max

B.16 High flow oxygen therapy (HiFlowO2)

High flow oxygen therapy¹ is indicated for adult, pediatric, and neonatal patients who are able to inhale and exhale spontaneously.

High flow oxygen therapy is an optional therapy in which a continuous flow of heated and humidified respiratory gases are delivered to the patient. The set flow can vary from 2 to 80 l/min depending on the patient interface. An operating humidifier is required.

The operator sets the oxygen and flow rate. It is also important to control the temperature and humidity of the gas delivered to the patient.

Pressure is measured at the ventilator's pressure release valve. Flow stops for at least 1 second if pressure exceeds 50 cmH2O. Therapy resumes when the pressure is released.

This respiratory support is usually delivered through a nasal cannula, with the flow exceeding the patient's peak inspiratory flow to provide inspired oxygen of up to 100%, while allowing the patient to talk, drink, or eat during the therapy.

High flow oxygen therapy can be delivered using single or double limb breathing circuits, using a high-flow nasal cannula or a tracheal adapter/tracheal mask to enable the patient to exhale.

Note that during high flow oxygen therapy, disconnection and apnea alarms are inactive.

When high flow oxygen therapy is in progress, the following parameters are monitored: **Oxygen**, **SpO2** related (when enabled), and **Control Flow** (in trend and as an MMP).

1. Not available in all markets.

Figure B-15 High flow oxygen therapy: Breathing pattern and controls

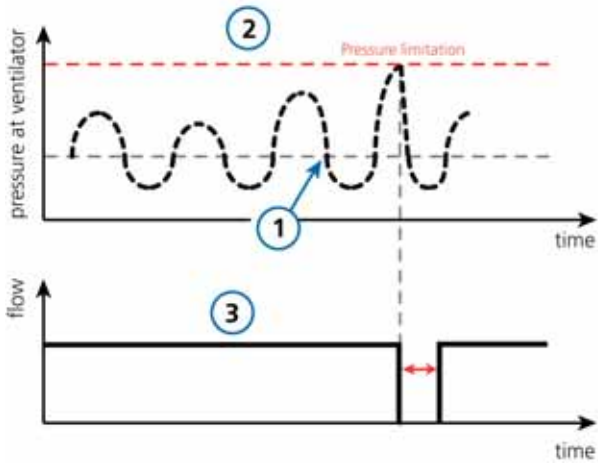

1 Pressure

3 Flow

2 Pressure limitation

Oxygen (*not shown*)

B.17 ASV mode

ASV[®] stands for *adaptive support ventilation*.

Adaptive Support Ventilation is an intelligent ventilation mode designed to make mechanical ventilation easier to use for the caregiver and safer and more comfortable for the patient.

The operator sets the %MinVol, PEEP, and Oxygen: %MinVol defines the percent of the patient's minute volume calculated according to its IBW and is a combination of Pinsp, Rate, Tidal volume (Vt), and I:E ratio.

ASV maintains an operator-preset, minimum minute ventilation independent of the patient's breathing activity.

The target breathing pattern (tidal volume and inspiratory rate) is calculated by the ventilator, based on the assumption that if the optimal breath pattern results in the least work of breathing, and the minimal force of breathing also results in the least amount of ventilator-applied inspiratory pressure when there is no patient breathing effort.

ASV adjusts inspiratory pressure and machine rate on a breath-by-breath basis taking into account the changing patient condition (resistance, compliance, RCexp) and applying lung-protective strategies to meet the targets.

A decrease in pressure limitation will follow with a decrease in tidal volume (Vt) and an increase in Rate.

It also encourages the patient to breathe spontaneously thus promoting an early extubation and shortening ventilation time.

ASV attempts to guide the patient using a favorable breathing pattern and avoids potentially detrimental patterns like rapid shallow breathing, excessive dead space ventilation, breath stacking (inadvertent PEEP), and excessively large breaths.

ASV does not eliminate the need for a physician or clinician and does not make clinical decisions. ASV executes a general command from the clinician and the clinician can modify it.

This command can be summarized, where the modifiable parts are in bold.

Maintain a **preset minimum minute ventilation**:

- Take spontaneous breathing into account
- Prevent tachypnea
- Prevent AutoPEEP
- Prevent excessive dead space ventilation
- Fully ventilate in apnea or low respiratory drive
- If the patient is able to breath unassisted
- All this without exceeding a Pinsp pressure of **10 cmH2O below the upper pressure limit**

Figure B-16 ASV mode: Breathing pattern and controls

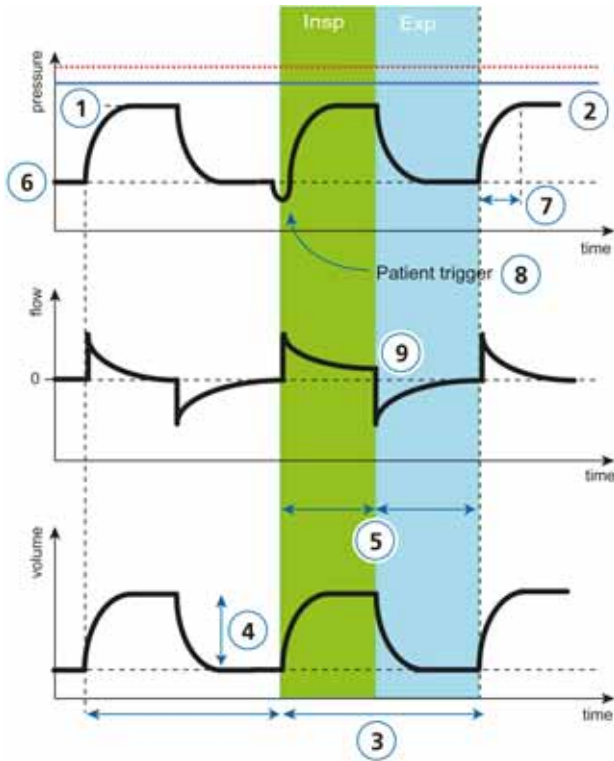
CO2 elimination

 1 P_{insp}
Automatically calculated

 2 P_{asvlimit}

 3 Rate
Automatically calculated

 4 V_t
Automatically calculated

 Sigh (*not shown*)

Oxygenation

 5 I:E
Automatically calculated

 6 PEEP/CPAP
Operator set

 Oxygen (*not shown*)
Operator set

 %MinVol.
Operator set

Patient synchronization

7 Pramp

8 Trigger

9 ETS

B.18 INTELLiVENT-ASV mode

INTELLiVENT-ASV is available as an option¹ for the HAMILTON-C3.

INTELLiVENT-ASV is an advanced ventilation mode, based on the proven Adaptive Support Ventilation (ASV) mode, to automatically regulate CO₂ elimination and oxygenation for both passive and active patients, based on both physiologic data from the patient and clinician-set targets.

With this mode, the clinician sets targets for PetCO₂ and SpO₂ for the patient.

INTELLiVENT-ASV then automates management of the controls for CO₂ elimination (%MinVol), and oxygenation (PEEP and Oxygen) based on these targets and on the physiologic input from the patient (PetCO₂ and SpO₂).

INTELLiVENT-ASV continuously monitors patient conditions and automatically and safely adjusts parameters to keep the patient within target ranges, with minimal clinician interaction, from intubation to extubation. See Figure B-16.

See the *INTELLiVENT-ASV Operator's Manual*.

1. Not available in all markets.

B.19 Safety mode/therapy

If the ventilator encounters certain error conditions, it may switch to safety ventilation or other special states until the situation is resolved.

If these conditions are encountered when delivering high flow oxygen therapy, the ventilator switches to Safety therapy.

B.19.1 Safety mode/therapy

In the event of certain technical failures, the ventilator switches to Safety mode/therapy. This gives you time to arrange for corrective actions, including organizing a replacement ventilator.

The following conditions apply to ventilation in Safety mode/therapy:

- The ventilator does not monitor patient inputs during Safety mode/therapy.
- During Safety mode, the blower runs constantly to create inspiratory pressure (P_{insp}) (Table B-4).

During Safety therapy, the blower creates a pressure of 5 cmH₂O at the inspiratory port.

- During Safety mode, the expiratory valve switches system pressure levels between PEEP and inspiratory pressure.
- You must turn off ventilator power to exit Safety mode/therapy.

Table B-4 Safety mode settings

IBW (kg)	P _{insp} (cmH ₂ O)	Rate (b/min)	Oxygen
< 3	15	≤ 35	> 21%
3 to 5	15	30	> 21%
6 to 8	15	25	> 21%
9 to 20	15	20	> 21%
21 to 29	15	15	> 21%
30 to 39	15	14	> 21%
40 to 59	15	12	> 21%
60 to 89	15	10	> 21%
90 to 99	18	10	> 21%
≥ 100	20	10	> 21%

For all patients, PEEP is set to the PEEP of the previous mode and the I:E ratio is 1:4 (Adult/Ped) and 1:3 (Neonatal).

B.19.2 Ambient state

If the technical fault alarm is serious enough to possibly compromise safe ventilation, the ventilator enters the Ambient state.

The following conditions apply to ventilation in the Ambient state:

- The inspiratory channel and expiratory valves are opened, letting the patient breathe room air unassisted.
- Provide alternative ventilation immediately.
- You must turn off ventilator power to exit the Ambient state.

C

ASV, Adaptive Support Ventilation

C.1	Overview	276
C.2	ASV and ASV 1.1	276
C.3	Setting up ASV	276
C.4	Clinical use of ASV	277
C.5	Ventilating with ASV	279
C.6	Weaning	282
C.7	Detailed functional description of ASV.	282
C.8	ASV technical data	288

C.1 Overview

This appendix describes the operation of the ASV[®] mode for the HAMILTON-C3 ventilator.

Adaptive Support Ventilation (ASV) is an intelligent ventilation mode designed to make mechanical ventilation safer and more comfortable for the patient.

ASV maintains an operator-preset, minimum minute ventilation independent of the patient's activity.

C.1.1 Indications for use

ASV is indicated for passively breathing and spontaneously breathing adult and pediatric patients.

C.1.2 Contraindications for use



ASV is **NOT** indicated for:

- neonates
- patients with a high leakage (non-invasive ventilation or broncho-pleural fistula).

C.2 ASV and ASV 1.1

ASV 1.1 is the default setting for the ASV mode. The previous version of ASV is also available on the device, in Configuration. See Section I.4.3.

C.2.1 Differences between ASV and ASV 1.1

ASV 1.1 extends the use of ASV with the following additional features and changes:

- Increased target rate and reduced tidal volumes for the majority of patients compared to standard ASV.
- In cases of high time constants and high minute volumes, V_{Tmax} is limited to 15 ml/kg.

- The target frequency in ASV 1.1 is calculated using algorithms based on the least work of breathing and the minimum force of breathing.

C.3 Setting up ASV

NOTICE

Hamilton Medical recommends setting the high pressure alarm limit at least 25 cmH₂O above PEEP/CPAP.

To set up the ventilator before connecting a patient

1. Prepare the device for clinical use as described in Chapter 2.
2. In the Standby window, do either of the following:
 - Select patient group, Adult/ped, or Last patient, and one of the three quick set up buttons.
 - Select patient gender and enter patient height.
3. Carry out preoperational checks and calibrations as described in Chapter 3.
4. Set the high Pressure alarm limit to an appropriate value.

The maximum peak pressure delivered in ASV (P_{asv}) is **10 cmH₂O below the high pressure alarm or equal to PASV limit**.

The maximum peak pressure for ASV can be also set using the P_{asv} control in the Controls window. Changing the P_{asv} value also changes the high Pressure limit.

5. In the Modes window, select **ASV** and touch **Confirm**.

The Controls window automatically opens.

6. Specify the following control settings:
 - **%MinVol.** A logical starting point is setting a **%MinVol** value that will result in the same minute volume as a previous mode, if applicable.
Add 20% if body temperature exceeds 38.5°C (101.3°F) and 5% per 500 m (1640 ft) above sea level.
 - **PEEP.** Set according to clinical requirements
 - **Oxygen.** Set according to clinical requirements
 - Set **Trigger, ETS, P-ramp** according to patient condition.
7. Touch **Confirm** to accept the settings.
8. Connect the patient to the ventilator and start ventilation. This initiates three test breaths.

C.4 Clinical use of ASV

Figure C-1 provides an overview of the ASV clinical workflow.

Figure C-1 Clinical use of ASV

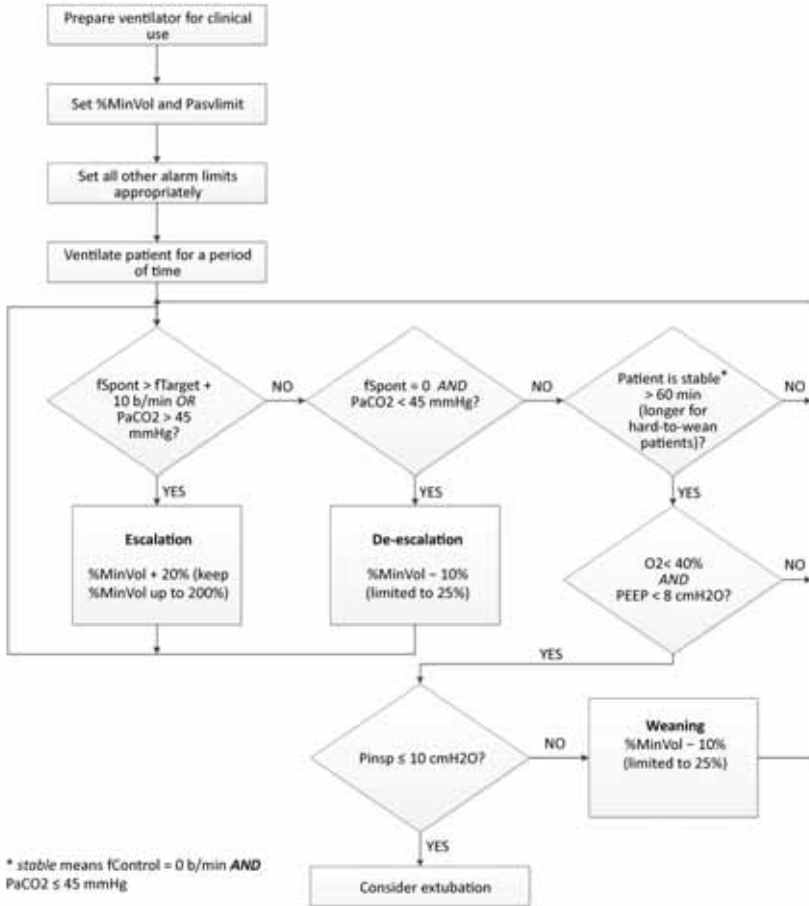

C.4.1 Compensation for changes in apparatus dead space

NOTICE

Changes in alveolar dead space due to ventilation/perfusion mismatch must be compensated using the %MinVol control.

The HAMILTON-C3 calculates the anatomical dead space based on the IBW calculated from the patient height input. Dead space is calculated as 2.2 ml per kg (1 ml per lb). This dead space is a nominal value that is valid, on average, for intubated patients whose endotracheal tube is connected to the Y-piece of the ventilator by a standard catheter mount. If this dead space is altered by an artificial airway configuration such as the use of a heat and moisture exchanging filter (HMEF) or non-standard tubing, modify the Patient height setting accordingly to take into account the added or removed dead space.

C.5 Ventilating with ASV

C.5.1 Maintaining adequate ventilation

WARNING

It is inappropriate to adjust the IBW (through the Patient height control) to change minute volume. Always use the %MinVol control to adjust minute volume.

Once ASV is started, the HAMILTON-C3 calculates an optimal breath pattern and associated target values for tidal volume and rate according to the rules in ASV, then adjusts the inspiratory pressure (P_{insp}), machine rate (f_{Control}), inspiratory and expiratory time, to achieve the targets. For lung protective rules strategy see Section C.7.3.

Once the calculated targets are reached, the result of the ventilation needs to be assessed. All HAMILTON-C3 monitored parameters can be used for this purpose. However, to assess respiratory acid-base status, it is recommended that arterial blood gases be measured and minute ventilation be adjusted accordingly. Table C-1 provides examples of how to adjust the %MinVol setting.

Table C-1 Blood gas and patient conditions and possible adjustments for ASV

Condition	%MinVol change	Remarks
Normal arterial blood gases	None	--
High PaCO ₂	Increase %MinVol	Pay attention to inspiratory pressures
Low PaCO ₂	Decrease %MinVol	Pay attention to mean pressures and oxygenation status

Table C-1 (continued) Blood gas and patient conditions and possible adjustments for ASV

Condition	%MinVol change	Remarks
High respiratory drive	Consider increase in %MinVol	Consider sedation, analgesia, or other treatments
Low O2 saturation	None	Consider increase in PEEP/CPAP and/or Oxygen

C.5.2 Reviewing alarm settings

To monitor the breathing pattern, you must review the alarm settings periodically and set them according to clinically acceptable values. As described below, ASV changes the breathing pattern according to the respiratory system mechanics and within the boundaries resulting from the operator’s settings for ASV. However, you can closely monitor ASV’s actions through the alarm system, since the alarm settings work totally independently of ASV.

It is possible to select a %MinVol that is incompatible with the lung-protective rules that govern ASV (for a detailed description, see Section C.7.3). As a consequence, ASV tries to achieve the maximum possible ventilation and activates the **ASV: Cannot meet target** alarm

Figure C-2 Example of high %MinVol setting incompatible with the lung-protective rules strategy

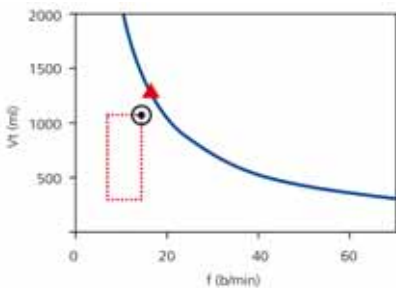

C.5.3 Monitoring ASV

ASV interacts with the patient continuously. Whenever the patient’s respiratory mechanics change, ASV adapts to this change. Whenever the patient’s breathing activity changes, ASV adapts. To let you view the current status, the HAMILTON-C3 provides the ASV target graphics (ASV Graph) window (Figure C-3).

To monitor progress over time, it is recommended that you plot trends for P_{insp} , f_{Total} , and f_{Spont} . Interpret these trends, together with the %MinVol setting. Table C-2 provides interpretation of typical ventilatory patterns.

For details on displaying the ASV Graph, see Section 7.4.

Figure C-3 ASV target graphics window

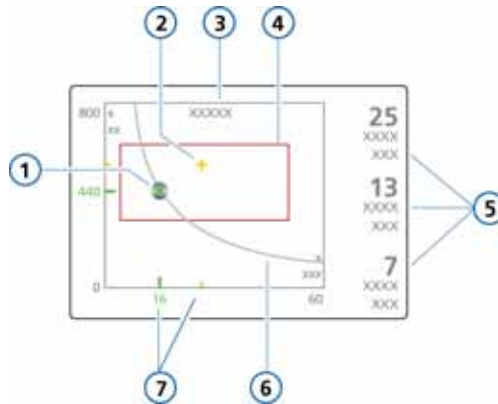

- | | |
|--|---|
| <p>1 Target point, formed by intersection of target tidal volume and target rate</p> <p>2 Current measured point, formed by intersection of measured tidal volume and rate</p> <p>3 Numerical value of target minute volume</p> <p>4 Safety frame in which target point may move</p> | <p>5 P_{insp} is the inspiratory pressure set by ventilator
f_{Control} is the machine rate
f_{Spont} is the spontaneous breath rate</p> <p>6 Minute volume curve</p> <p>7 Numerical value of the current measured point (in yellow) and relative position of the target value (in green)</p> |
|--|---|

Table C-2 Interpretation of breathing pattern at lower than 100% MinVol setting

P _{insp}	f _{Control}	f _{Spont}	Interpretation
>10	> 10	0	Danger of hypoventilation. Check arterial blood gases and consider increasing %MinVol.
>10	0	Acceptable	Enforced weaning pattern. Monitor arterial blood gases and patient respiratory effort. Consider decreasing or increasing %MinVol accordingly.
< 8	0	Acceptable	Unsupported breathing. Consider extubation.
>10	0	High	Dyspnea. Consider increasing %MinVol and other clinical treatments. Check for autotriggering.

C.6 Weaning

Weaning patients from the ventilator is a clinical task that requires tremendous experience and involves more than just ventilation issues. This appendix does not intend to provide clinical information other than that needed to operate the ventilator with ASV.

ASV always allows patients to take spontaneous breaths. Episodes of spontaneous breathing can occur and are supported by ASV even within a period of fully controlled ventilation. In other words, weaning can start with ASV so early that it may go unrecognized clinically. It is therefore important to monitor the spontaneous efforts of the patient over time.

The weaning progress can be monitored in the trends display when inspiratory pressure (P_{insp}), total rate (f_{Total}), and spontaneous rate (f_{Spont}) are plotted.

It may be necessary to reduce the %MinVol setting to 70% or even lower to “motivate” the patient to resume spontaneous breathing. If a patient can sustain minutes or even hours with a low %MinVol setting, it does not mean that weaning is complete. In fact, the %MinVol setting must always be interpreted in conjunction with the level of P_{insp} needed to achieve the set minute ventilation. Only if P_{insp} and f_{Control} are at their minimal values can weaning be assumed to be complete.

C.7 Detailed functional description of ASV

NOTICE

Some ventilation-related equations in the text are assigned a number, (x), which is then used as reference in the text.

C.7.1 Normal minute ventilation

ASV defines normal minute ventilation according to the graph in Figure C-4.

Figure C-4 Normal minute ventilation as a function of ideal body weight (IBW)

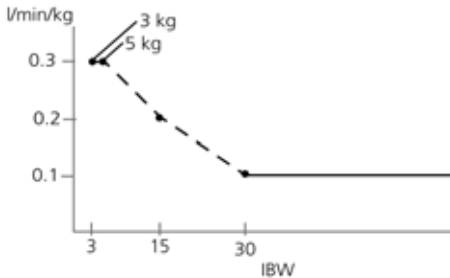

For patients with an IBW \geq 30 kg, minute ventilation is calculated as 0.1 l/kg * IBW (solid line). For patients with an IBW < 30 kg, the value is indicated by the dotted line. Minute ventilation for a 15 kg patient thus is calculated as

$$0.2 \text{ l/kg} * 15 \text{ kg} = 3 \text{ l/min}$$

For example, for an IBW of 70 kg, normal minute ventilation corresponds to 7 l/min.

C.7.2 Targeted minute ventilation

When you chose ASV, you must select an appropriate minute ventilation for the patient. Minute ventilation is set with the %MinVol control, which, together with the Patient height control, determines the total minute ventilation in liters per minute.

A %MinVol setting of 100% corresponds to a normal minute ventilation, see section C.7.1. A setting less than 100% or higher than 100% corresponds to a minute ventilation lower or higher than normal.

From the %MinVol, the target minute ventilation (in l/min) is calculated as:

$$\text{Body weight (in kg)} \times \text{NormMinVent (in l/kg/min)} \times (\% \text{MinVol}/100)$$

where NormMinVent is the normal minute ventilation. See Figure C-4.

For example, with a %MinVol = 100 and an IBW = 70 kg, a target MinVol of 7 l/min is calculated. This target can be achieved with a number of combinations of tidal volume (V_t) and respiratory rate (f). This is shown in Figure C-5, where all possible combinations of V_t and f lie on the bold line, the target minute volume curve.

Figure C-5 MinVol = 7 l/min

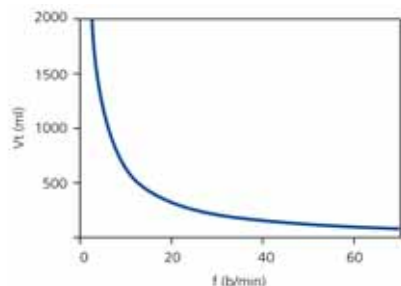

All possible combinations of V_t and f that result in a minute ventilation of 7 l/min lie on the bold line.

C.7.3 Lung-protective rules strategy

Not all combinations of V_t and f shown in Figure C-5 are safe for the patient. The high tidal volumes will over distend the lungs and the small tidal volumes cannot produce alveolar ventilation at all. Another risk lies in inadequate respiratory rates. High rates can lead to dynamic hyperinflation or breath stacking, and thus inadvertent PEEP. Low rates can lead to hypoventilation and apnea. Therefore, it is necessary to limit the number of possible combinations of V_t and f .

When limits are imposed on the possible combinations of V_t and f , then ASV uses a double strategy:

- The operator input for ASV determines the absolute boundaries.
- Internal calculations based on patient measurements further narrow the limits to counteract possible operator errors and to follow changes of respiratory system mechanics.

The effect of the strategy is shown in Figure C-6 and explained in the subsequent sections.

Figure C-6 Lung-protective rules strategy

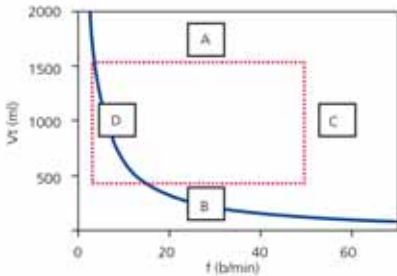

A: High tidal volume limit

WARNING

Check the Vt high setting to make sure the target minute ventilation can be reached in passive patients.

The tidal volume applied by ASV is limited (see A in Figure C-6) by three operator settings: high Pressure alarm limit, Vt high alarm limit, and Patient height.

The operator must set the high Pressure limit before connecting a patient to the ventilator. The maximum pressure to be applied in the ASV mode is 10 cmH₂O below the high Pressure limit.

If the operator sets the Pressure limit to a very high pressure, say 60 cmH₂O, the target volume is limited by the second criterion: 15 ml/kg.

Additionally the target volume is limited to 1.5 * VT high limit, and pressure support actually is limited in a way that the inspired volume does not exceed Vt high limit in mechanical breaths for more than a few breaths.

B: Low tidal volume limit

To determine the minimum target Vt in ASV (see B in Figure C-6) use the IBW calculated from the Patient height, which corresponds to 4.4 ml/kg.

The operator must use caution with low tidal volumes to avoid insufficient alveolar ventilation. The determining parameter for alveolar ventilation is dead space (VDaw). Tidal volume value must always be greater than the VDaw value. It is widely accepted that a first approximation of dead space can be obtained by the following simple equation (Radford 1954).

The lower limit for tidal volume is based on this equation and calculated to be at least twice the dead space. Or, the minimum Vt is 4.4 x IBW.

$$VDaw = 2.2 * IBW (1)$$

C: High rate limit

You derive the maximum rate (see C in Figure C-6) from the operator-set %MinVol and the calculated IBW, which is calculated from the operator-set Patient height. The equation used to calculate the maximum rate is:

$$fmax = target MinVol / minimum Vt (2)$$

However, if you choose an excessively high %MinVol of 350%, the maximum rate becomes 77 b/min. To protect the patient against such high rates, ASV employs a further safety mechanism, which takes into account the patient's ability to exhale.

A measure of the ability to exhale is the expiratory time constant (RCexp). To achieve a nearly complete exhalation to the equilibrium point of the respiratory system (90% of the maximum potential volume change), an expiratory time of at least 2 x RCexp is theoretically required.

For this reason, ASV calculates the maxi-

mum rate based on the principle of giving a minimum inspiratory time equal to $1 \times RC_{exp}$ and a minimum expiratory time equal to $2 \times RC_{exp}$, which results in these equations:

$$f_{max} = 60 / (3 \times RC_{exp}) = 20 / RC_{exp}$$

$$f_{max} \leq 60 \text{ b/min (3)}$$

This limit applies to the respiratory rate of the ventilator only, *not* to the respiratory rate of the patient.

D. Low rate limit

The lowest target rate (see D in Figure C-6) is predefined according to the IBW. See Tables C-4 and C-5.

C.7.4 Optimal breath pattern

Although the lung-protective rules strategy limits possible combinations of V_t and f , ASV prescribes an explicit target combination. Using the example in Figure C-6, this shows considerable room for selection within the dotted rectangle. The selection process is an exclusive feature of ASV. The device works on the assumption the optimal breath pattern is identical to the one a totally unsupported patient will choose naturally (assuming the patient is capable of maintaining the pattern).

It is common knowledge that the choice of breathing pattern is governed by either work of breathing, or the force needed to maintain a pattern. ASV calculates the optimal rate based on operator entries of %MinVol and the IBW (based on the Patient height setting) as well as on the measurement of RC_{exp} (see Section C.8).

Once the optimal rate is determined, the target V_t is calculated as:

$$V_t = \text{target MinVol} / \text{optimal rate (4)}$$

Figure C-7 shows the position of the target breathing pattern as well as the safety limits imposed by the lung-protective rules strategy.

Figure C-7 Anatomy of the ASV target graphics window

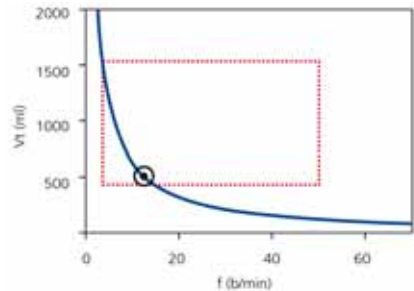

The rectangle shows the safety limits; the circle shows the target breath pattern.

C.7.4.1 Initial breaths: How ASV starts

How does the operator make this determination: how to achieve the target values in a given patient if it is not known whether or not the patient can breathe spontaneously? For this purpose, ASV uses a predefined rate according to the set IBW. For more information see Tables C-4 and C-5.

Each breath triggered by the patient is pressure-supported and flow-cycled, or, the transition to exhalation is made based on flow. In contrast, if the patient does not trigger the breath, the delivery of the breath is pressure-preset and time-cycled.

The following controls are operator-set (manual):

- PEEP/CPAP
- Oxygen
- P-ramp
- ETS
- Trigger type and sensitivity

This list of controls is adjusted automatically by ASV, and cannot be adjusted by the operator:

- Mandatory breath rate: to change total respiratory rate
- Inspiratory pressure level: to change inspiratory volume
- Inspiratory time: to allow gas flow into the lungs
- Startup breath pattern

To safely start ASV, the operator inputs the Patient height setting, which is used to calculate the IBW.

Three initial test breaths are delivered. The resulting rate and tidal volume are measured and compared with the target values. ASV then responds to the differences between the actual and target V_t as well as the actual and target rates.

C.7.4.2 Approaching the target

Figure C-8 shows a possible scenario after the three initial test breaths. The actual breath pattern, which is plotted as the patient symbol, shows clear deviation from the target. The task of ASV is now to move the patient symbol as close to the circle as possible.

Figure C-8 Example of a situation after the three initial breaths

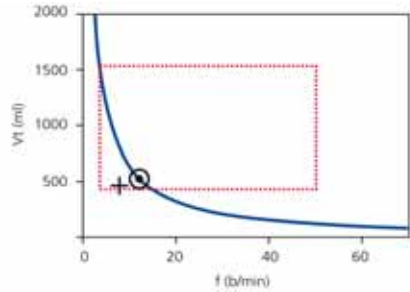

The patient symbol marks the actual measured values for V_t and rate.

To achieve the target, use this strategy:

- If actual $V_t <$ target V_t , the inspiratory pressure is increased.
- If actual $V_t >$ target V_t , the inspiratory pressure is decreased.
- If actual $V_t =$ target V_t , the inspiratory pressure is left unchanged.
- If actual rate $<$ target rate, the f_{Total} rate is increased.
- If actual rate $>$ target rate, the f_{Total} rate is decreased.
- If actual rate $=$ target rate, the f_{Total} rate is left unchanged.

As a result, the patient symbol in Figure C-8 moves toward the circle. The actual V_t is calculated as the average of inspiratory and expiratory volumes of the last 5 breaths. This definition compensates in parts for leaks in the breathing circuit, including the endotracheal tube.

C.7.5 Dynamic adjustment of lung protection

The operator preset values are not changed by ASV, and the corresponding safety limits remain as defined above. However, if the respiratory system mechanics change, the safety limits change accordingly and as defined in Section C.7.3. The safety limits are updated on a breath-by-breath basis.

For example, if the lungs stiffen, the high V_t limit is lowered proportionally, and the high Rate limit is increased.

This dynamic adjustment ensures that ASV applies a safe breathing pattern at all times. In graphical terms, the dotted rectangle changes as shown in Figure C-9.

Figure C-9 Lung-protective limits

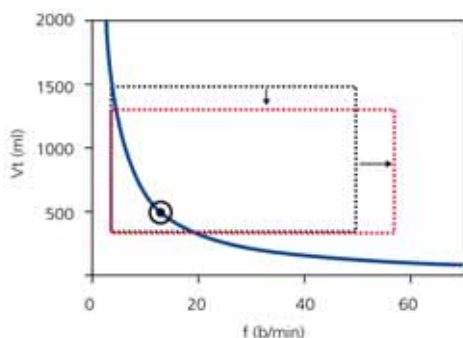

Lung-protective limits are changed dynamically and according to the respiratory system mechanics.

However, the limits derived from the operator input are never violated.

C.7.6 Dynamic adjustment of optimal breath pattern

After it is calculated, the optimal breath pattern is revised with each breath according to the measurements of RC_{exp} . A new target breathing pattern is calculated using ASV algorithms. The targets do not change under steady-state conditions. However, if the patient's respiratory system mechanics change, the target values also change.

C.8 ASV technical data

Table C-3 lists technical data related to ASV.

Table C-3 ASV technical data

ASV-related operator settings	
%MinVol	25% to 350%
Patient height	Adults: 130 to 250 cm / 50 to 100 in Pediatric: 30 to 150 cm / 12 to 60 in
Internal calculations	
IBW	In kg, calculated based on Patient height and Gender (see Section 4.2)
MinVol (target)	In l/min, target minute volume is calculated as: IBW (in kg) x NormMinVent (in l/kg/min) x %MinVol/100 where NormMinVent is the normal minute ventilation from Figure C-4.
fTotal	In b/min
VDaw	2.2 ml/kg IBW
Vt (target)	MinVol / f(target)
ASV monitor	
Target values (numerical)	MinVol, Vt, fTotal
Current achieved values (numerical)	MinVol, Vt, fTotal, Vt = (VTI+VTE)/2
Status of patient (numerical)	fSpont, fControl, Pinsp
Graphics display (curve)	fTotal versus Vt, target value, current value, safety boundaries
Alarms	
All alarms are functional except apnea alarms	See Chapter 8
Special	ASV: Check high press limit, ASV: Cannot meet target
Performance specifications	
Response time (90% of steady state)	< 1 min (typical)
Overshoot/undershoot	< 25%
Maximum pressure change per breath	2 cmH2O
Settling time	< 120 s
Steady state deviation	< 10%

Table C-3 ASV technical data

Lung-protective rules	
Maximum Vt	Depends on high Pressure alarm limit and volume/pressure ratio (V/P). Always < 22 x IBW. Limited to 1.5 x Vt high.
Minimum Vt	4.4 x IBW
Maximum machine rate	The maximum rate in ASV is the smallest value of the following conditions: <ul style="list-style-type: none"> • 60 b/min • 23 b/min * %MinVol/100 / (Weight ≥ 30 kg) • 20/RCexp
Minimum target rate	5 to 15 b/min
Maximum P _{insp}	High Pressure alarm limit - 10 cmH ₂ O - PEEP
Minimum P _{insp}	5 cmH ₂ O above PEEP/CPAP
Minimum inspiratory time (T _I)	0.5 s or RC _{exp} , whichever is longer
Maximum inspiratory time (T _I)	2 s
Minimum expiratory time (T _e)	2 x RC _{exp}
Maximum expiratory time (T _e)	12 s
I:E range	1:4 to 1:1
Maximum tidal volume	15 ml/kg

C.8.1 ASV startup settings

When ASV is started, the device delivers three test breaths. The device automatically selects the values for total frequency rate (f_{Total}), inspiratory time (TI), and inspiratory pressure (P_{insp}) based on the calculated IBW, which is determined from the operator-set Patient height and Gender settings and as specified in the following tables.

Table C-4 Initial breath pattern for Adult settings

IBW (kg)	P _{insp} (cmH ₂ O)	TI (s)	Rate (b/min)	Minimum target rate (b/min)
30 to 39	15	1	14	7
40 to 59	15	1	12	6
60 to 89	15	1	10	5
90 to 99	18	1.5	10	5
> 100	20	1.5	10	5

Table C-5 Initial breath pattern for Pediatric settings

IBW (kg)	P _{insp} (cmH ₂ O)	TI (s)	Rate (b/min)	Minimum target rate (b/min)
3 to 5	15	0.4	30	15
6 to 8	15	0.6	25	12
9 to 11	15	0.6	20	10
12 to 14	15	0.7	20	10
15 to 20	15	0.8	20	10
21 to 23	15	0.9	15	7
24 to 29	15	1	15	7

D

NIV, noninvasive ventilation

D.1	Benefits of noninvasive ventilation	292
D.2	Required conditions for use	293
D.3	Contraindications	293
D.4	Potential adverse reactions	294
D.5	Selecting a patient interface	294
D.6	Control settings.	294
D.7	Alarms	295
D.8	Monitored parameters.	295
D.9	Additional notes about using noninvasive ventilation	296
D.10	References	297

NOTICE

- Noninvasive ventilation in critically ill patients should only be used by properly trained and experienced personnel.
- As a precaution, you must be prepared to intubate the patient and start invasive ventilation at any time while noninvasive ventilation is in use.
- The use of a mask can increase dead space. Always comply with the mask manufacturer's instructions when using noninvasive ventilation.
- If you are using the neonatal noninvasive mode nCPAP-PS, see Chapter 5.

The noninvasive ventilation mode (NIV) and the spontaneous/timed noninvasive ventilation mode (NIV-ST) are implementations of noninvasive positive pressure ventilation (NPPV). NPPV can use as its patient interface a mask, mouthpiece, or helmet-type interface, rather than an invasive conduit such as an endotracheal tube.

Used for years in home care and subacute care settings, NPPV can also benefit intensive care ventilation patients by decreasing the need for intubation and promoting early extubation. Benefits such as reduced mortality (COPD patients), reduced ventilation time (COPD and ARF patients), and reduced complication rates (of ventilator-associated pneumonias) have been clearly demonstrated^{1,2}.

Intended for actively breathing patients, noninvasive ventilation is provided through a nonvented or nonported mask interface. Because this open breathing circuit permits air to leak around the mask or through the mouth, the ventilator achieves and maintains the prescribed pressure by adjusting the inspiratory flow. If the leak is large, the ventilator's inspiratory flow can be large—up to 240 l/min—thus compensating at least in part for most leaks. The NIV modes were also designed to minimize nuisance leak-related alarms.

NIV is an adaptation of the SPONT mode, while NIV-ST is an adaptation of the PSIMV+ mode. The primary difference between SPONT and NIV or PSIMV+ and NIV-ST is that SPONT and PSIMV+ are designed for an intubated patient, while the NIV modes are designed for use with a mask or other noninvasive patient interface. See Appendix A for technical details about the ventilator's noninvasive modes.

D.1 Benefits of noninvasive ventilation

Noninvasive ventilation offers these short-term benefits^{3,4}:

- Relieves respiratory symptoms
- Optimizes patient comfort
- Reduces work of breathing
- Improves or stabilizes gas exchange
- Improves patient-ventilator synchrony

1. Mehta S et al. Noninvasive ventilation. *Am J Respir Crit Care Med* 2001 Feb;163(2):540-77.

2. Hess DR. The evidence for noninvasive positive-pressure ventilation in the care of patients in acute respiratory failure: a systematic review of the literature. *Respiratory Care* 2004 Jul;49(7):810-25.

3. Mehta S et al. Noninvasive ventilation. *Am J Respir Crit Care Med* 2001 Feb;163(2):540-77.

4. Hess DR. The evidence for noninvasive positive-pressure ventilation in the care of patients in acute respiratory failure: a systematic review of the literature. *Respiratory Care* 2004 Jul;49(7):810-25.

- Minimizes risks associated with aspiration, intubation, injury to the mucus membranes and teeth, and circulatory reactions

Noninvasive ventilation offers these long-term benefits:

- Improves sleep duration and quality
- Maximizes quality of life
- Enhances functional status
- Prolongs survival

D.2 Required conditions for use

CAUTION

- *To prevent possible patient injury, DO NOT use noninvasive ventilation on patients with no or irregular spontaneous breaths. Noninvasive ventilation was intended to provide supplemental ventilatory support to patients with regular spontaneous breaths.*
- *To prevent possible patient injury, DO NOT attempt to use noninvasive ventilation on intubated patients.*

Ensure these requirements are met to use noninvasive ventilation:

- The clinician's instructions must be strictly followed.
- The patient must not be intubated.
- The patient must be able to trigger the ventilator and must have regular spontaneous breaths.
- The patient must be conscious.
- The patient must be able to maintain an adequate airway.
- The patient must be monitored by external monitors.
- Intubation must be possible at any time.
- The mask should fit face structures well.

D.3 Contraindications

- Intolerance of interface
- Inability to trigger breath
- Facial or brain injury
- Recent upper airway or esophageal surgery
- Hemodynamic instability
- Gastric distension
- Inability to protect airway

D.4 Potential adverse reactions

- Aspiration, gastric insufflation
- Conjunctivitis
- Increase of intracranial pressure (ICP)
- Decrease of arterial pressure
- CO₂ rebreathing claustrophobia
- Discomfort/dys-synchrony
- Skin lesions

D.5 Selecting a patient interface

CAUTION

Make sure to follow the instructions for use of the manufacturer when using any noninvasive patient interface. Incorrectly used masks can cause skin irritations.

The quality and performance of the patient interface largely determine the effectiveness of noninvasive ventilation.

The following types of interfaces are supported:

- Face (oronasal) mask that covers the mouth and nose
- Nasal mask that covers the nose only
- Mouthpiece
- Helmet

In general, an interface used with the noninvasive modes must meet these requirements:

- It must be of the nonvented/nonported design
- Gas leakage should be controllable at low mask application pressures

- The material in contact with the face should be soft, biocompatible, and nonallergenic
- It should be easy to install and remove
- It should remain properly positioned when the patient moves their head

If you try using a nasal mask, but there is significant gas leakage through the open mouth, switch to a face mask.

D.6 Control settings

WARNING

The exhaled volume from the patient can differ from the measured exhaled volume due to leaks around the mask.

CAUTION

Peak pressures exceeding 33 cmH₂O may increase the risk of aspiration due to gastric insufflation¹. When ventilating with such pressures, consider using an invasive mode.

When a significant leak occurs, the inspiratory flow can never fall below ETS, thus not allowing the ventilator to cycle into exhalation and resulting in endless inspiration. For this reason, the TI max setting was added, providing an alternative way to cycle into exhalation. When inspiration lasts longer than TI max, the ventilator cycles into exhalation.

When the ventilator cycles are based on ETS setting rather than TI max, it is the most comfortable for the patient. Ensure the TI max setting is sufficiently long to

1. Bach JR, Alba AS, Saporito LR. Intermittent positive pressure ventilation via the mouth as an alternative to tracheostomy for 257 ventilator users. Chest 1993;103:174-182.

give ETS the chance to cycle the ventilator. Adjusting the **TI max** setting increases or decreases the allowable inspiratory time. Increasing ETS above the default 25% allows the ventilator to cycle to terminate inspiration at a higher flow, to accommodate larger leaks.

Other controls require special attention. Carefully observe the patient/ventilator interaction. The leakage in this mode reduces the actual applied PEEP/CPAP and give rise to autotriggering. Adjust **Psupport** or **Pinsp** to obtain appropriate tidal volumes. Adjust PEEP/CPAP further, considering oxygenation and AutoPEEP.

D.7 Alarms

NOTICE

The Inspiratory volume limitation alarm is inactive in noninvasive modes.

Due to the changing and unpredictable amount of leakage, volume alarms are less meaningful in noninvasive than in other modes. Alarms are based on the returned expiratory gas volume measured at the flow sensor; this value can be significantly lower than the delivered tidal volume, because the delivered tidal volume is the sum of the displayed **VTE** and the leakage volume. To avoid nuisance volume alarms, set the low **Vt** and **ExpMinVol** alarms to a low level.

Because the noninvasive modes are pressure modes, however, do pay attention to the pressure-related alarms. If the defined PEEP and inspiratory pressure can be maintained, the ventilator is compensating the gas leak sufficiently.

D.8 Monitored parameters

NOTICE

- Due to the changing and unpredictable amount of leakage, these numeric monitoring parameters cannot be used for reliable analysis of patient conditions: **ExpMinVol**, **RCexp**, **Rinsp**, **Insp Flow**, **AutoPEEP**, and **Cstat**. Continuous monitoring of the clinical parameters and patient comfort is of critical importance.
- The parameters **VTE NIV**, **MinVol NIV**, **MVSpont NIV**, and **MVLeak** are leak compensated, and are used in noninvasive modes. These parameters are estimations and may not reflect exact values.

Due to the leakage at the patient interface, displayed exhaled volumes in the noninvasive modes can be substantially smaller than the delivered volumes. The flow sensor measures the delivered volume and the exhaled tidal volume; the ventilator displays the difference as **VLeak** in %, and as **MVLeak** in l/min. Use **VLeak** and **MVLeak** to assess the fit of the mask or other noninvasive patient interface.

While a leak at the patient interface influences the tidal volume measurement, leaks in the breathing circuit itself do not influence the tidal volume measurement.

Besides all the other clinical parameters, **TI**, **Ppeak**, **PEEP/CPAP**, **I:E**, **fTotal**, **Pmean**, and **fSpont** can be used to assess the patient's ventilatory status.

D.9 Additional notes about using noninvasive ventilation

NOTICE

If the mask fit cannot be improved, select an alternative treatment method.

Due to some unique characteristics of noninvasive ventilation, consider the following points when using it. Consistent with best practices, monitor the patient closely to evaluate the adequacy of the prescribed therapy.

Patient Synchronization

To optimize patient synchronization, it is important to adjust trigger and ETS according to patient's effort.

IntelliTrig (intelligent trigger) function

With its IntelliTrig function, the ventilator can automatically adapt to changing breath patterns and system leaks to achieve optimum synchronization between patient and device.

To synchronize, IntelliTrig compensates any leaks and resistances between the ventilator and the patient, and with each breath it measures the leakage at the patient interface (mask). With this information IntelliTrig adapts the trigger mechanism so leakage and the changing breath pattern do not influence the operator-set trigger sensitivity (flow or pressure trigger).

Maintaining PEEP and preventing auto-triggering

Significant leakage can be present in noninvasive ventilation, which can serve to reduce the actual applied PEEP/CPAP and give rise to autotriggering. If you cannot reach the set PEEP/CPAP, check the mask fit.

The ventilator maintains PEEP with the expiratory valve in combination with a compensating base flow delivered by the check valve through the breathing circuit.

The Loss of PEEP alarm alerts you to uncompensated leaks (that is, when the measured PEEP/CPAP is 3 cmH₂O lower than the set PEEP/CPAP).

Inspect mask fit and position

For noninvasive ventilation to function as intended, the mask must fit well and remain in place.

Inspect the mask position regularly and adjust as necessary. If the mask slides away from the mouth and nose (patient disconnection), reinstall and secure it. React promptly and appropriately to any alarms.

The ventilator's Leak parameter provides one indicator of mask fit. To check the proper fit of the mask verify that the patient can trigger and flow-cycle inspiration and by verify that:

$$P_{\text{peak}} = (\text{PEEP/CPAP} + P_{\text{support}}/P_{\text{insep}}) \pm 3 \text{ cmH}_2\text{O}$$

CO2 rebreathing in noninvasive ventilation

CO2 rebreathing per breath can increase in noninvasive ventilation. Typically this is not critical, because there is also generally significant leakage in noninvasive ventilation. CO2 rebreathing can occur because there is not the usual dead space reduction from an endotracheal tube or tracheostomy. And because the mask or other noninvasive interface creates additional dead space. Consider this additional dead space when prescribing a specific type of noninvasive patient interface. Despite the use of a noninvasive interface, the dead space ventilation per minute can decrease when the therapy results in an increase in tidal volume and decrease in respiratory rate.

D.10 References

References are available on the Hamilton Medical website, www.hamilton-medical.com.

E

CO₂ sensor option: Volumetric capnography

E.1	Overview	300
E.2	CO ₂ elimination ($V'CO_2$)	300
E.3	End-tidal CO ₂ (PetCO ₂ and FetCO ₂)	301
E.4	Airway dead space (VDaw)	301
E.5	Alveolar minute ventilation (V'_{alv})	302
E.6	Capnogram shape	302
E.7	Formulas	304
E.8	References	304

E.1 Overview

The ventilator uses volumetric capnography as the method to assess the quality and quantity of ventilation.

The device is able to provide volumetric capnography measurements such as:

- The **CO2 elimination ($V'CO_2$)** measurement permits assessment of metabolic rate (for example, it is high with sepsis, tetanus, and so on) and treatment progress.
- The **end-tidal CO2 (PetCO2 and FetCO2)** measurements permit assessment of arterial CO2 (Notice that they are inaccurate in pulmonary embolism.).
- The **airway dead space ($VDaw$)** and alveolar minute ventilation ($V'alv$) measurements permit assessment of actual alveolar ventilation (as opposed to minute ventilation).
- The **capnogram shape (slopeCO2)** permits assessment of COPD, asthma, and inefficient ventilation.
- The **physiological dead space fraction (VD/Vt)** permits assessment of risk (Nuckton 2002).

E.2 CO2 elimination ($V'CO_2$)

To convert a time-based capnogram into a volumetric capnogram, CO2 must be combined with flow. Figure E-3 shows the volume of CO2 exhaled in one breath, combining a typical FetCO2 versus time curve (Figure E-1) with the flow curve (Figure E-2) for a mechanically ventilated patient.

The area under the expiratory curve (B) minus the area under the inspiratory curve (A) is the net transfer of CO2 out of the lungs per breath, or VCO_2 .

CO2 elimination ($V'CO_2$) is obtained by adding VCO_2 over several breaths and dividing the sum by the total time in minutes (Noe 1963). Steady-state conditions are essential to interpret the $V'CO_2$ values (Brandt 1999). $V'CO_2$ thus represents CO2 elimination but not necessarily CO2 production. Normal values for $V'CO_2$ can be found in the reference literature or in Table E-1.

Figure E-1 Typical capnogram of patient on pressure-controlled ventilation, showing fractional concentration of CO2 plotted against time.¹

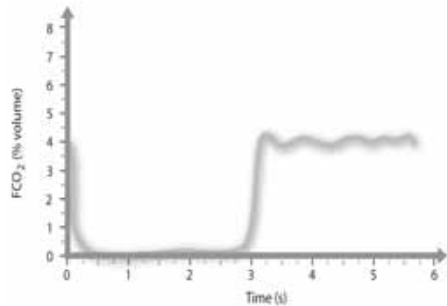

1. Inspiration starts at time 0; exhalation, at approximately 2.75 sec. Notice that inspiratory gas initially contains CO2 (rebreathing) that is washed out of the Y-piece.

Figure E-2 Typical spirogram of a patient on pressure-controlled ventilation (same breath as shown in Figure E-1).¹

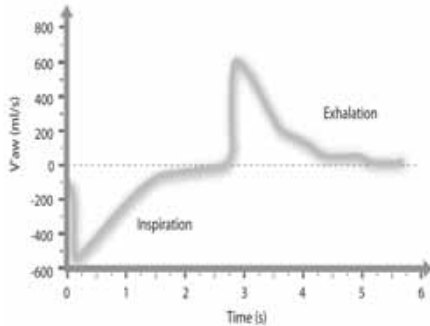
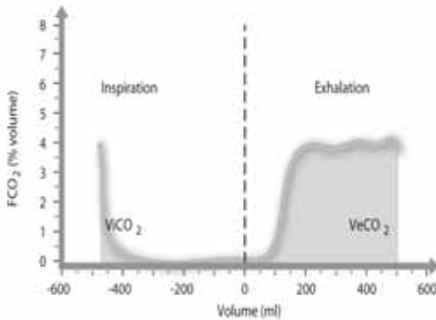

Figure E-3 Combination of capnogram and spirogram (fractional end-tidal CO₂ concentration plotted against volume)²



1. The flow into the patient (inspiration) is negative, while the flow out of the patient (exhalation) is positive. The expiratory flow curve is an exponential decay curve. Notice that in spontaneously breathing subjects, the flow curves may be of different shapes.
2. ViCO₂ is the volume of inspired CO₂, while VeCO₂ is the volume of exhaled CO₂. The net elimination of CO₂ is VeCO₂ - ViCO₂. ViCO₂, which is a negative volume indicating rebreathed CO₂, is normally omitted.

E.3 End-tidal CO₂ (PetCO₂ and FetCO₂)

The maximum value of CO₂ measured during exhalation is normally considered the end-tidal CO₂ value, and is either given as a partial pressure (PetCO₂), or as a fractional concentration of CO₂ in dry gas (FetCO₂).

Normal values for PetCO₂ and FetCO₂ can be found in the literature or in Table E-1.

E.4 Airway dead space (VDaw)

NOTICE

The airway dead space (VDaw) is in approximation to the anatomical dead space.

Airway dead space measurement using a volumetric capnogram gives an effective, in-vivo measure of volume lost in the conducting airways. By dividing the capnogram into phases³ (Figure E-4), VDaw can be calculated as the smallest measurable dead space, essentially the volume exhaled up until phase II. The calculation, described in literature (Wolff 1989 and Aström 2000), consists of a number of computational steps, which take the slope of the alveolar plateau into account.

Normal values for VDaw can be found in the literature or in Table E-1.

3. In an early detailed description (Folkow 1955), the capnogram can be thought of as being divided into phases: phase I (no CO₂ present), phase II (rapid rise in CO₂), and phase III (alveolar plateau).

Figure E-4 Interpretation of volumetric capnogram¹

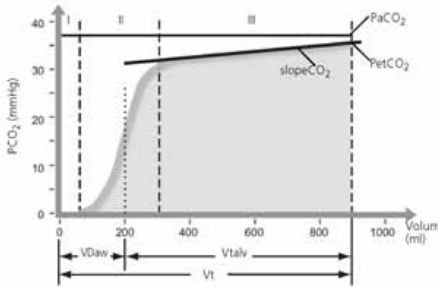

Therefore, V'_{alv} is the pertinent parameter to measure ventilation.

Not all gas that enters the alveoli participates in gas exchange. Some gas ends up in non- or under-perfused lung spaces. To measure the efficiency of alveolar ventilation, $PaCO_2$ must be determined from an arterial blood gas sample. The ratio of mixed to ideal alveolar partial pressure is a measure of alveolar efficiency (Severinghaus 1957).

Normal values for V'_{alv} can be found in the literature or in Table E-1.

E.5 Alveolar minute ventilation (V'_{alv})

Minute ventilation includes not only ventilation of the lungs, but also ventilation that is wasted in the airways. Thus, high minute ventilation does not conclusively indicate the actual alveolar reach. For example, a tidal volume of 100 ml at 80 b/min yields the same minute ventilation as a tidal volume of 500 ml at 16 b/min, yet it has no real benefit to the patient since only dead space ventilation occurs. Alveolar ventilation is defined as

$$V'_{alv} = \text{MinVol} - V'Daw$$

where

$$\text{MinVol} = f \cdot Vt$$

and

$$V'Daw = f \cdot VDaw$$

or

$$V'_{alv} = f \cdot (Vt - VDaw)$$

E.6 Capnogram shape

The slope of the alveolar plateau (slope- CO_2) is a characteristic of the volumetric capnogram shape. This slope is measured in the geometric center of the curve, which is defined as the middle two quarters lying between $VDaw$ and the end of exhalation (Wolff 1989, Aström 2000). A steep slope is seen in COPD patients, while a flat plateau is seen in postoperative patients. A steep slope in normal patients may indicate a technical problem.

Normal values for slope CO_2 can be found in the literature or in Table E-1.

1. Phase I: pure airway dead space, from point of measurement of CO_2 toward the lungs. Phase II: weighted average of alveolar gas from different lung spaces, at the sensor location; measurement is $VDaw$. Phase III: alveolar plateau; measurement is slope CO_2 together with end-tidal CO_2 , $PetCO_2$, or $FetCO_2$.

Table E-1 Examples of “normal” or expected values in mechanically ventilated patients¹

Description	Unit ²	Normal	Reference
VDaw	ml BTPS	2.2 ml/kg IBW	Radford 1954
slopeCO ₂	%CO ₂ /l	31324*Vt - 1.535	Aström 2000
V'CO ₂ ³	ml/min STPD	2.6 to 2.9 ml/min/kg	Weissmann 1986, Wolff 1986
FetCO ₂ ⁴	%	5.1% to 6.1%	Wolff 1986
V'alv	mmHg (kPa)	36 mmHg (4.8 kPa)	Kiiski, Takala 1994 ⁵
VD/Vt	ml/min BTPS	52 to 70 ml/min/kg actual body weight	
VD/Vtbohr	--	Normal: 0.36 to 0.42 High: > 0.63 ±0.1	Kiiski, Takala 1994, Wolff 1986, Nuckton 2002 ⁶

1. These values are for illustration purposes and do not replace physician-directed treatment.
2. Bulk gas volumes such as minute ventilation and tidal volumes are usually measured in BTPS. Specific gas volumes are expressed in STPD. Conversion factors can be found in physics textbooks.
3. $V'CO_2 = V'alv * FetCO_2$
4. $FetCO_2 = PetCO_2/(Pb-PH_2O)$
5. $V'alv = V'CO_2/FetCO_2$ STPD,
Lower value of normal range: $V'alv = 2.6/0.061 = 43*ml*kg/min*STPD = 52*ml*kg/min*BTPS$
Upper value of normal range: $V'alv = 2.9/0.051 = 57*ml*kg/min*STPD = 70*ml*kg/min*BTPS$
6. VD/Vtbohr is equivalent to VD/Vt if PetCO₂ is identical to PaCO₂. In normal lungs, this is the case. In diseased lungs, however, PetCO₂ and PaCO₂ are not identical. The classic example is pulmonary embolism.

E.7 Formulas

Alveolar tidal ventilation (V_{talv})

$$V_{talv} = V_t - V_{Daw}$$

Alveolar minute ventilation (V'_{alv})

$$V'_{alv} = f \cdot V_{talv}$$

Volume of CO2 eliminated in one breath (V_{CO2})

$$V_{CO2} = V_e \cdot F_{eCO2} - V_i \cdot F_{iCO2}$$

Fractional concentration of CO2 in exhaled gas (F_{eCO2})

$$F_{eCO2} = V'_{CO2} / \text{MinVol}$$

Partial pressure of CO2 in exhaled gas (P_{eCO2})

$$P_{eCO2} = F_{eCO2} \cdot (P_b - P_{H2O})$$

Bohr dead space fraction (V_{Dbohr}/V_t)

(Note: V_t in this formula needs to be in ml STPD)

$$V_{Dbohr}/V_t = 1 - (V_e \cdot F_{eCO2} / (V_t \cdot F_{iCO2}))$$

Physiological dead space fraction (V_D/V_t)

$$V_D/V_t = 1 - ((V_e \cdot F_{eCO2} / V_t) / (P_{aCO2} / (P_b - P_{H2O})))$$

E.8 References

References are available on the Hamilton Medical website, www.hamilton-medical.com.

F

Pneumatic diagram

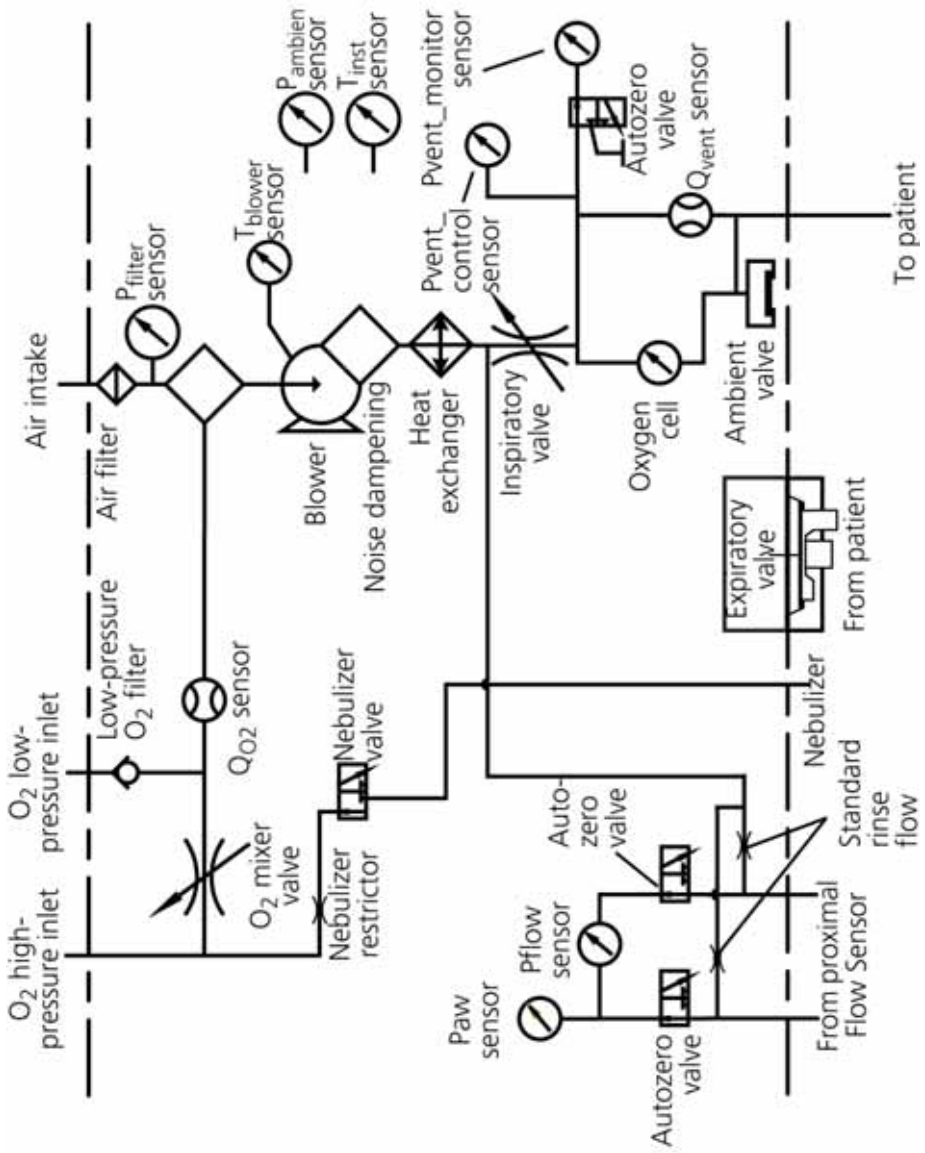

G

Parts and accessories

G.1 Overview

This appendix lists the parts available for the HAMILTON-C3 ventilator.

WARNING

To ensure proper ventilation operation, use only parts and accessories specified in this appendix and in the product catalog, or that are specified as being compatible with this ventilator.

NOTICE

- Not all parts are available in all markets.
- For additional parts and accessories, see the product catalog or contact your Hamilton Medical representative.

Figure G-1 Ventilator parts and accessories

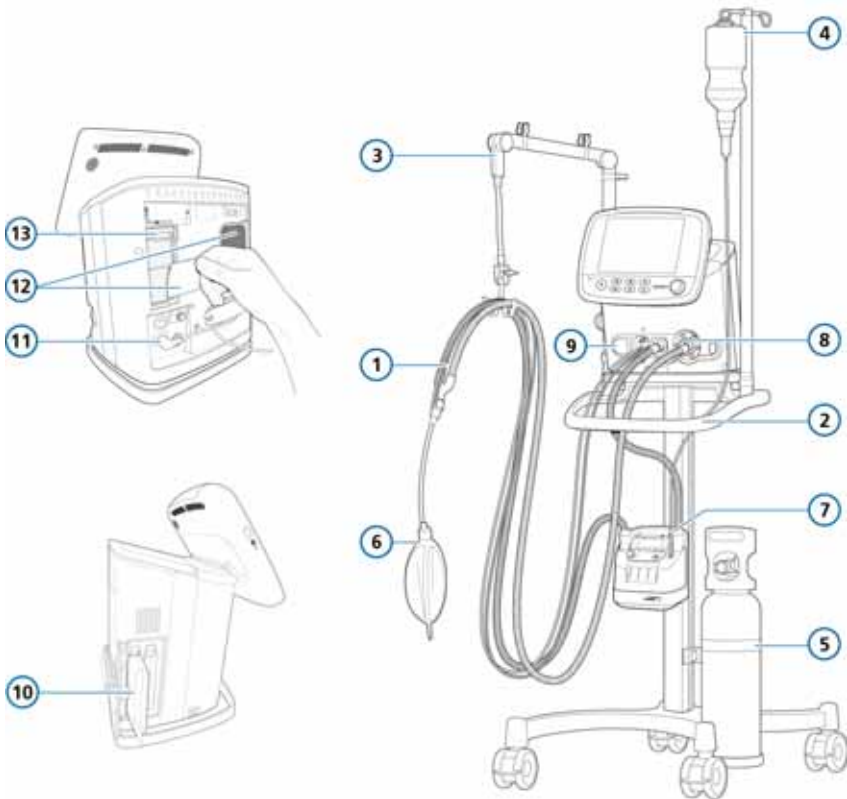

Table G-1 Ventilator parts and accessories

Item no. (Fig. G-1)	Description	PN
1	HAMILTON-H900 breathing set, pediatric/adult, single-use, with water chamber, temperature probe, and all in-one connector	
	Breathing set BC8022, dual limb, pre-assembled, box of 15	260161
	Breathing set adult, autoclavable, 22 mm ID, 22/22 mm	
	Double water trap, box of 1	151990
	Single water trap, box of 1	151976
	Without water trap, box of 1	260036
	Breathing set pediatric, autoclavable, 15 mm ID, 15/15 mm	
	Double water trap, box of 1	260038
	Single water trap, box of 1	260035
	Without water trap, box of 1	260037
1	Breathing set neonatal, autoclavable, 12 mm ID, 12/12 mm	
	Single water trap, box of 1	151969
1	Breathing set, pediatric/adult, single use	
	Breathing circuit, coaxial, length 1.8 m, box of 20	260206
	Breathing set, coaxial, with flow sensor, length 1.8 m, box of 20	260207
	Breathing circuit, length 2.40 m, box of 10	260239
	Breathing set, with flow sensor, length 2.40 m, box of 10	260240
1	Flow sensors	
	Flow sensor, pediatric/adult, single patient use, 1.88 m, box of 10	281637
	Flow sensor, pediatric/adult, autoclavable, 1.88 m, box of 1	950185
	Flow sensor, neonatal, single patient use, 1.6 m, box of 10	260177
	Flow sensor, neonatal, single patient use, 1.88 m, box of 10	155500
	Flow sensor, neonatal, single patient use, 3.1 m, box of 10	260179

Table G-1 Ventilator parts and accessories (continued)

Item no. (Fig. G-1)	Description	PN
<i>not shown</i>	CO2 mainstream measurement	
	HAMILTON CAPNOSTAT-5™ CO2 sensor	281718
	CO2 adult airway adapter single patient use, box of 10	281719
	CO2 neonatal airway adapter single-patient use, package of 10	281720
	CO2 adult airway adapter reusable, box of 1	281721
	CO2 neonatal airway adapter, reusable, box of 1	281722
	15 mm male/female adapter for neonatal-pediatric flow sensor, single patient use, box of 25	281803
<i>not shown</i>	CO2 sidestream measurement	
	HAMILTON LoFlow™ sidestream CO2 sensor	281928
	CO2 sidestream adult/pediatric airway adapter, single patient use, box of 10	281929
	CO2 sidestream adult/pediatric airway adapter with dehumidification, single patient use, box of 10	281931
	CO2 sidestream pediatric adapter, single patient use, box of 10	281930
	CO2 sidestream neonatal airway adapter with dehumidification, single patient use, box of 10	281932
7	Humidifier	
	HAMILTON-H900 <i>For details, see the HAMILTON-H900 Product Catalog</i>	624686
2	Trolley	
	Trolley (incl. humidifier support)	160150
	Humidifier support	160151
	Counterweight	160585
	E-Size cylinder holder	160505
3	Tubing support arm, for use with quick lock	160153
	Quick lock mount	160154
4	Infusion arm, for use with quick lock	160162
5	Gas cylinder holder	160152

Table G-1 Ventilator parts and accessories (continued)

Item no. (Fig. G-1)	Description	PN
6	Demonstration lung	
	IntelliLung, maximum 1 liter	281869
	Demonstration lung assembly with endotracheal tube, adult, 2 liter, with 15 mm male connector	151815
	Demonstration lung assembly with endotracheal tube, 0.5 l, with 15 mm male x 22 mm male connector (pediatric)	151816
	Demonstration lung, neonatal, 15 mm <i>A passive lung simulator with two independent compartments for simulating neonatal patients.</i>	R53353
	Filter	
12	Filter set <i>Includes 5 sets. Each set includes 2 air intake dust filters and 1 fan filter.</i>	160215
13	Filter, air intake (HEPA)	160216
	Patient filter	
	HMEF, adult	279963
	Expiratory bacteria filter	279204
	HME, adult	279974
	Inspiratory bacteria filter	279211
11	Power cord	
	Power cord with US plug, 2-pin	355198
	Power cord with British angled-plug	355199
	Power cord with continental European plug, 2-pin	355200
	Power cord with Chinese plug, 2-pin	355308
8	Expiratory valve	
	Expiratory valve assembly, reusable (incl. membrane, expiratory valve)	160245
	Membrane, expiratory valve, reusable, box of 5	160500
9	Oxygen cell	396200
<i>not shown</i>	Communication	
	Extended communication board CO2, Nurse Call	160140
	Extended communication board, Nurse Call	160143

Table G-1 Ventilator parts and accessories (continued)

Item no. (Fig. G-1)	Description	PN
	Cable, Nurse Call	160166
	Cable, HAMILTON-C3 RS-232 serial connector to computer, 2.5 m (8.2 ft) <i>Shielded on male (ventilator) side only.</i>	160366
10	Battery	
	Li-Ion battery	369106
	Battery charger/calibrator	369104
<i>not shown</i>	High-pressure oxygen connector	
	DISS – diameter index safety standard	160470
	NIST – no interchangeable screw thread	160471
<i>not shown</i>	Gas-supply hoses and parts	
	Coupling insert 4.8 mm ID for low pressure O2 inlet	279913
<i>not shown</i>	Equipotential cable	
	Equipotential cable, POAG EU	160374
	Equipotential cable, USA	160577
<i>not shown</i>	Masks and accessories <i>See the online catalog</i>	689304
	nCPAP-PS Starter kit, large (10 sets incl. mask, prongs, and bonnets)	281975
	nCPAP-PS Starter kit, small (1 set incl. mask, prongs, and bonnets)	282330
	Neonatal circuit adapter	160595

Table G-1 Ventilator parts and accessories (continued)

Item no. (Fig. G-1)	Description	PN
<i>not shown</i>	SpO2 sensors and accessories	
	Masimo SET SpO2 pulse oximeter <i>See the online catalog</i>	
	Masimo Rainbow SET (SW option) <i>See the online catalog</i>	
	Finger probe	281947
	Multi-site	281948
	Finger-tip probe, regular	281949
	Finger-tip probe, large	281950
	Adult finger or toe probe, 24pcs/set	281951
	Child finger or toe probe, 24pcs/set	281952
	Neonate instep, 24pcs/set	281953
	Neonatal finger or toe probe, 24pcs/set	281954
	Multi-site Y probe, 5pcs/set	281955
	Attachment tape S, 24pcs/set	281956
	Attachment tape L, 24pcs/set	281957
	Clip adapter	281958
	Nebulizer and accessories <i>See the online catalog</i>	689304
	Adapters <i>See the online catalog</i>	689304
	Tools and test equipment <i>See the online catalog</i>	689304
	Language kit	
	English	160033
	German	160034
	Spanish	160035
	French	160036
	Italian	160037
	Russian	160040
	Chinese	160041
	Portuguese	160042

Table G-1 Ventilator parts and accessories (continued)

Item no. (Fig. G-1)	Description	PN
<i>not shown</i>	DC input cables	
	Car adapter for HAMILTON-C3	160187
	Mounting options	
	Bed mount with cylinder mount	160144
	Wall mount for bed mount	160145
	Universal bed mount kit	160148
	Quick-lock mounting plate	160466
	Extended warranty	
	Extended warranty of 1 year	700703
	Extended warranty of 2 years	700704
	Extended warranty of 3 years	700705

H

Communications interface

H.1	Overview	316
H.2	About the communication protocols	316
H.3	Using the RS-232 interface	318
H.4	Using the Nurse Call (6-pin) interface.	321

H.1 Overview

WARNING

- Additional equipment connected to medical electrical equipment must comply with the respective IEC or ISO standards (for example, IEC 60950-1 for data processing equipment). Furthermore, all configurations shall comply with the requirements for medical electrical systems (see IEC 60601-1, clause 16).
- Anybody connecting additional equipment to medical electrical equipment configures a medical system and is, therefore, responsible that the system complies with the requirements for medical electrical systems. Note that local laws take priority over the above-specified requirements. If you have questions about how to proceed, consult your Hamilton Medical representative or technical service department.

NOTICE

- The option board includes EMI-protective covers for the connector ports. When a port is not in use, make sure the cover is in place, sealing the port.
- The HAMILTON-C3 can be used with Philips monitors and the VueLink open interface.
- The delay time between the start of an alarm condition and the signal leaving the interface's input/output port is typically 500 ms. The time it

takes for the message to appear on the connected monitor display depends on the specific patient monitor.

The communications interface provides the following data transfer options, depending on what is configured:

Table H-1 Data transfer options

Using the ...	The ventilator can ...
RS-232 connector on the ventilator	Send monitored data, ventilator settings, and alarms to a patient monitor, a patient data management system (PDMS), or other computer system. See Section H.3.
Nurse Call connector on the communication board	Send alarm signals to a nurse call device. For details, see Section H.4.

H.2 About the communication protocols

The interface uses three general protocol types, described here briefly. For more detailed information and specifications, contact your Hamilton Medical representative.

Table H-2 Protocol overview

	Philips VueLink Open	Polling protocol (legacy)	Block protocol (new)
Transmission frequency	Continuous	Polling	Continuous
Transmission speed	<ul style="list-style-type: none"> • 19200 baud • 8 data bits, 1 stop bit • Parity: none • Handshake: none 	<ul style="list-style-type: none"> • 9600 baud • 7 data bits, 2 stop bits • Parity: EVEN • Handshake: XON/XANY 	<ul style="list-style-type: none"> • 38400 baud • 8 data bits, 1 stop bit • Parity: none • Handshake: none
Waveforms	6 waveforms, sent 2 at a time	4 waveforms Resolution: <ul style="list-style-type: none"> • Flow at 2.5 ml/s • Volume at 2.5 ml 	8 high-resolution waveforms Resolution: <ul style="list-style-type: none"> • Flow at 0.1 ml/s • Volume at 0.1 ml
Transmittable data Settings, measurements, waveforms, alarms, modes, device info	Subset	Subset	All
Available protocols in ventilator configuration (<i>Configuration > General > More</i>) See Tables H-3, H-4, and H-5	Philips Open VueLink <i>Philips-specific standard protocol for transmitting data, offers preconfigured data mapping</i>	<ul style="list-style-type: none"> • Galileo compatible (simulates a Galileo ventilator) • Hamilton P2 (standard polling protocol) • Hamilton (backward compatibility) • DrägerTestProtocol (for Dräger MIB II converter with Infinity monitoring) 	Block Protocol
Additional information			Two modes: wave (waveform data only) and mixed (default, support for sending waveform and/or parameter data)

H.3 Using the RS-232 interface

Using the RS-232 connector on the ventilator, you can connect to

- Patient monitors (Section H.3.1)
- Patient data management system (PDMS) or other computer system (Section H.3.3)

H.3.1 Connecting to a patient monitor

⚠ CAUTION

- *To prevent possible patient injury when using a patient monitor, check the patient and the ventilator whenever the monitor reports a ventilator alarm. It is possible that detailed information about the alarm may not be displayed on the monitor.*
- *Use the Dräger Test Protocol for Dräger devices only.*

NOTICE

- As part of configuring the communications interface, outgoing data from the ventilator (parameters and labels, alarms and messages) is mapped to specific display and behavior characteristics on connected patient monitors. As a result of the specified mapping:
 - Your monitor may not recognize and report all modes and parameters (for example, ASV mode, peak pressure monitoring parameter). In addition, the alarm message on the monitor may differ from the message displayed on the ventilator.

In such cases, we recommend that you read the data directly from the HAMILTON-C3 display.

- Silencing the HAMILTON-C3's audible alarm **may not** automatically silence the audible alarm of a connected patient monitor.
- To connect the HAMILTON-C3 to a monitor other than those described, contact the monitor manufacturer.

Using the RS-232 connector on the ventilator, the ventilator can send monitored data, settings, and alarms to a patient monitor.

Communication comprises two primary components:

- Hardware connection
This connection requires the components shown in Figure H-1, as well as specific interface hardware ordered directly from the patient monitor manufacturer (Table H-3).
- Data mapping
For more detailed information and specifications, contact your Hamilton Medical representative.

Figure H-1 Connection to a patient monitor

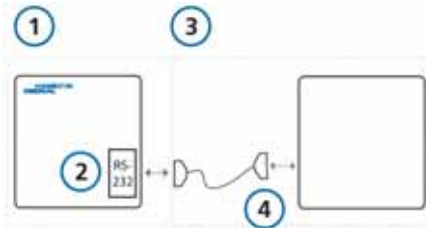

- | | |
|---|--|
| <p>1 Components available from Hamilton Medical</p> <p>2 Ventilator and RS-232 port</p> | <p>3 Third-party components</p> <p>4 Patient monitor, interface, and RS-232 communications cable</p> |
|---|--|

Table H-3 Supported patient monitor manufacturers and associated communications protocols

Manufacturer	Product name	Protocol
<i>Select the protocol in the device Configuration > General > More window</i>		
Philips	IntelliVue (Vue-Link)	Open Vue-Link
	IntelliVue (IntelliBridge)	
Nihon Kohden	BSM-9101K (v12-06 or later)	Hamilton
	BSM-6000K (v02-10 or later)	
Dräger	Infinity	DrägerTest-Protocol
Mindray	Beneview	Hamilton / Hamilton P2

H.3.2 Changing the communication protocol

If needed, you can change the communication protocol.

To change the communication protocol

- Access configuration mode by touching the tools button at the bottom of the screen, and then touching the **Configuration** tab.
- For details on how to access configuration mode see Section I.2.
- Open the General -> More window (Figure H-2).
- Touch the arrow button to open the drop-down menu.
- Turn the P&T knob to select the desired communication protocol.
- Press the knob to confirm your selection.
- Wait ten seconds, then restart the ventilator.

Figure H-2 Communication protocol configuration

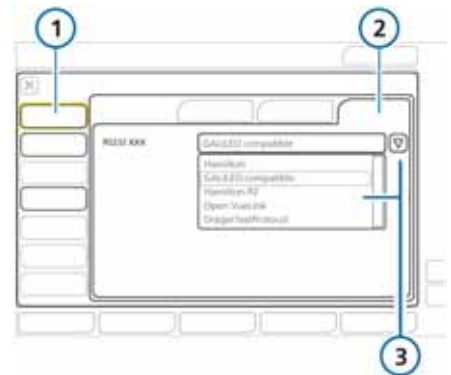

- | | |
|--------------------------------|-------------------------------|
| <p>1 General</p> <p>2 More</p> | <p>3 Available interfaces</p> |
|--------------------------------|-------------------------------|

H.3.3 Connecting to a PDMS or computer

Using the RS-232 connector on the ventilator, the ventilator can send monitored data, settings, and alarms to a patient data management system (PDMS) at a hospital, or to another computer system.

Access to the data can be useful for data management and clinical studies. Data from the ventilator can be analyzed using a variety of software tools, and can also be made part of a patient’s electronic health record (EHR).

In addition, you can use the Hamilton Medical DataLogger software for research purposes using an RS-232 cable (PN 160366). For details, contact your Hamilton Medical representative.

This connection requires the hardware shown in Figure H-3.

Table H-4 lists supported PDMS manufacturers and the associated protocol to use. In some cases, additional middleware solutions may be required to interface to the desired system; see Table H-5.

Figure H-3 Connection to a PDMS or computer

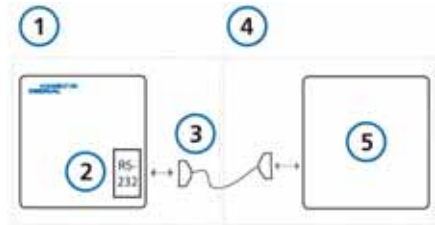

- | | |
|--|--|
| <ul style="list-style-type: none"> 1 Components available from Hamilton Medical 2 Ventilator and RS-232 port 3 RS-232 communications cable for use with the DataLogger software (PN 160366) | <ul style="list-style-type: none"> 4 Third-party components 5 Patient monitor, interface, and communications cable |
|--|--|

Table H-4 Supported PDMS manufacturers and associated protocols

Manufacturer	Product name	Protocol
<i>Select this protocol in the device Configuration > General > More window</i>		
GE Healthcare	Centricity™ Critical Care	GALILEO compatible
iMDsoft	MetaVision	Hamilton
Dräger	Integrated Care Manager (ICM)	GALILEO compatible / Hamilton P2
Cerner	BMDI Device Interface	Hamilton P2
AGFA	ORBIS	Hamilton / Hamilton P2
Precept Health Ltd	ICU Care	Hamilton / Hamilton P2
LOWTeq	LOWTeq-PDMS intensive care	GALILEO compatible / Hamilton P2

Table H-5 Supported middleware and associated protocols

Manufacturer	Product name	Protocol
Capsule Technologie	DataCaptor	Hamilton P2
Bridge-Tech	Device Connectivity Solution (DCS)	Hamilton / Hamilton P2

H.3.4 RS-232 connector pin assignments

The RS-232 connector has the pin assignments shown in Figure H-4. The RS-232 cable (PN 160366) uses the wiring shown in Figure H-5.

Figure H-4 RS-232 pin assignments

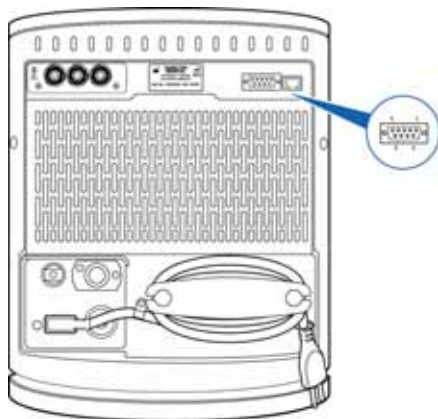

1	--	6	DSR
2	RxD	7	RTS
3	TxD	8	CTS
4	DTR	9	--
5	GND (signal ground)	Shield	Chassis ground

Figure H-5 RS-232 cable (PN 160366) wiring diagram

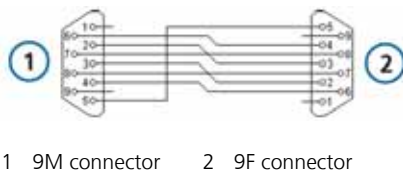

H.4 Using the Nurse Call (6-pin) interface

⚠ CAUTION

The maximum allowable voltage and current between the relay contacts are 48 V, 0.5A.

The 6-pin connector on the option board is labeled *Nurse Call*.

Using the Nurse Call connector on the option board, the ventilator can send the following signals to a nurse call device or other device in a different location:

- Alarm signals (Section H.4.1)
- I:E timing signals (Section H.4.2)

The ability to send alarm signals to an external device is referred to as *remote alarm* or *nurse call* capability.

H.4.1 Sending alarm signals to a remote device

WARNING

Before using the remote alarm function, check that alarms are being properly transmitted to the remote device.

CAUTION

If the remote alarm function is used in an isolation ward, regularly check that alarms are being properly transmitted to the remote device.

The remote alarm (nurse call) capability allows alarms to be displayed and heard at locations other than the ventilator. This function is useful, for example, when the ventilator is in an isolation room, and the alarm signals must be transmitted to a different location.

The ventilator Alarm silence key silences the audible portions of the alarms at both the ventilator and the remote device.

The remote alarm capability is based on relays inside the ventilator. This application requires the 6-pin Nurse Call cable (PN 160166) and final assembly of the cable at your site. For details about the cable, connectors, and pin assignments, see the *Nurse Call Cable Setup Guide (PN 624344)*.

H.4.2 Sending inspiratory: expiratory (I:E) timing signals

Using the 6-pin Nurse connector on the option board, the ventilator can send I:E timing signals to an external device.

This application requires the hardware shown in Figure H-6.

The I:E timing capability is based on a relay inside the ventilator. For details, see the *Nurse Call Cable Setup Guide (PN 624344)*.

Figure H-6 Connection to external device using 6-pin Nurse connector

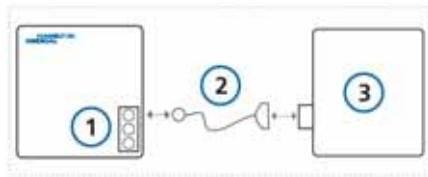

- 1 Ventilator and option board with Nurse call port
- 2 Nurse call cable (PN 160166)
- 3 External device

H.4.3 Nurse 6-pin connector pin assignments

For details on the Nurse call cable, connector, and pin assignments, see the *Nurse Call Cable Setup Guide (PN 624344)*.



Configuration

1.2	Accessing Configuration mode	324
1.3	Configuring general settings	324
1.4	Selecting breath timing, mode naming, and ASV version options	326
1.5	Configuring the MMP display	327
1.6	Setup window (quick setup configuration).	327
1.7	Copying configuration settings to a USB memory device	331
1.8	Configuring software and hardware options	331

1.1 Overview

During configuration, you set up the ventilator with a default language, main monitoring parameter display, startup settings for a new patient, and unit of measure for pressure, among other settings.

1.2 Accessing Configuration mode

You can access Configuration mode when the ventilator is in Standby. Access requires a configuration code; contact your administrator.

Figure I-1 Accessing configuration

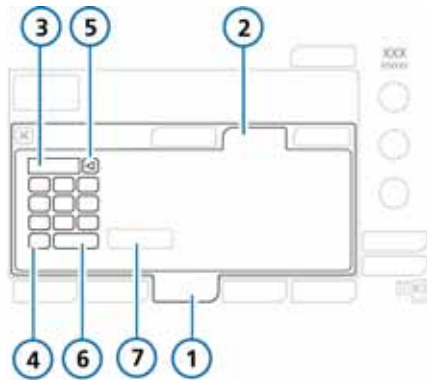

- | | |
|---------------------------|------------------------|
| 1 Tools | 5 Delete |
| 2 Configuration | 6 Enter |
| 3 Text field to type code | 7 Configuration button |
| 4 Keypad | |

To access Configuration mode

1. Touch the **Tools** button at the bottom of the screen, and then touch the **Configuration** tab.

2. Touch the text field and, using the keys on the onscreen keypad, type the configuration code; then touch **Enter**.
The **Configuration** button is enabled.
3. Touch the **Configuration** button.
The configuration window appears, displaying the Language tab.

You can now define settings and add options.

1.3 Configuring general settings

You can configure some general default settings for the ventilator, including language, units of measure, and communication interface to use

1.3.1 Language: Selecting the default language

Open the General -> Language window and select the desired language for screen display.

Figure I-2 Language configuration window

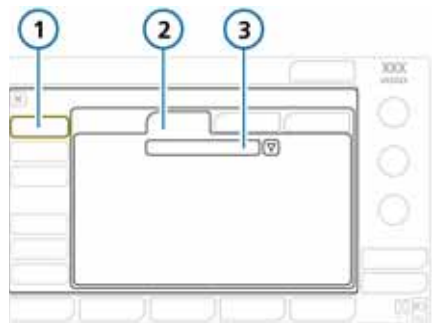

- | | |
|-------------|-----------------|
| 1 General | 3 Language list |
| 2 Languages | |

I.3.2 Selecting the default units of measure

Open the General -> Units window and select the unit of measure for pressure, length and CO2 display.

Figure I-3 Units configuration

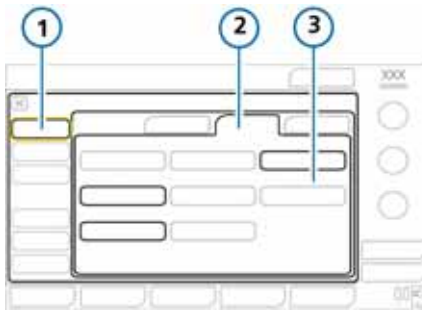

- | | |
|-----------|-------------------------------|
| 1 General | 3 Pressure, CO2, Length units |
| 2 Units | |

I.3.3 Setting the minimum alarm loudness (volume)

You can set a minimum alarm loudness (volume) setting for the device. Once set, the device operator cannot set the alarm volume below the value set here in Configuration.

Figure I-4 Minimum alarm loudness configuration

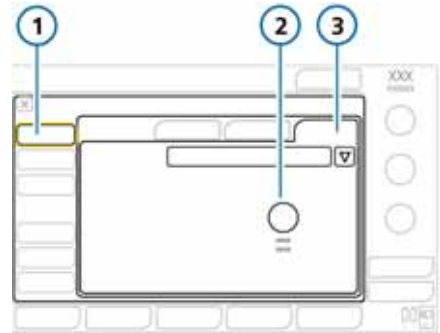

- | | |
|-----------|-----------------|
| 1 General | 3 Min. loudness |
| 2 More | |

To set the minimum alarm loudness (volume)

1. Open the General -> More window (Figure I-4).
2. Touch the **Min. Loudness** button and choose the minimum alarm volume to allow on the device. By default, set to 1.
3. Continue setting configuration options or exit Configuration mode.

The setting is applied to the device. Note that if the new minimum is greater than the currently set alarm volume, the alarm volume is reset to the new minimum level.

To verify the setting, check the **Loudness** value in the System -> Settings window.

I.4 Selecting breath timing, mode naming, and ASV version options

In the Configuration > Modes > General > Philosophy window, you can set:

- Mandatory breath timing philosophy to use for PCV+ and APVcmv modes
- Naming convention for volume controlled pressure adaptive modes
- ASV version

Figure I-5 Setting breath timing and labeling options

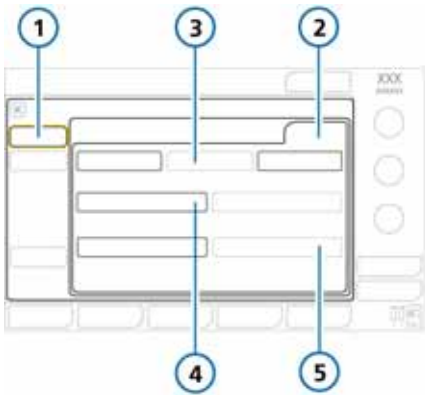

- | | | | |
|---|-----------------------|---|------------------------|
| 1 | General | 4 | Mode naming convention |
| 2 | Philosophy | 5 | ASV selection |
| 3 | Breath timing options | | |

I.4.1 Setting breath timing options

The ventilator controls mandatory breath timing using a combination of inspiratory time (TI) and rate. For two modes, PCV+ and APVcmv (or (S)CMV+), you can set the ventilator to use any of the following combinations to control breath timing:

- I:E/Pause
- TI/Pause
- Peak flow/Tip

To change breath timing for PCV+ and APVcmv ((S)CMV+) modes

- ▶ In the Configuration > Modes > General > Philosophy window (Figure I-5), touch the desired breath timing option.

I.4.2 Choosing the mode naming convention

You can select the naming convention used for adaptive (pressure regulated and volume targeted) modes.

By default, the APVcmv/APVsimv convention is used.

To select the mode naming convention

- ▶ In the Configuration > Modes > General > Philosophy window (Figure I-5), select either **APVcmv/APVsimv** (default) or **(S)CMV+/SIMV+**.

1.4.3 Choosing the ASV version

By default, the device uses ASV version 1.1.

If desired you can set the device to use the standard ASV version. For details, see Appendix C.

To select the ASV version

- ▶ In the Configuration > Modes > General > Philosophy window (Figure I-5), select either **ASV 1.1** (default) or **ASV**.

1.5 Configuring the MMP display

You can define a default set of main monitoring parameters (MMPs) to display on the ventilator.

Open the Graphics -> MMP window (Figure I-6). Select the desired parameter to be displayed in that position on the screen. Repeat for the remaining parameters.

Ppeak is always displayed as an MMP, but you can choose in which of the five slots to display it.

Figure I-6 MMP configuration

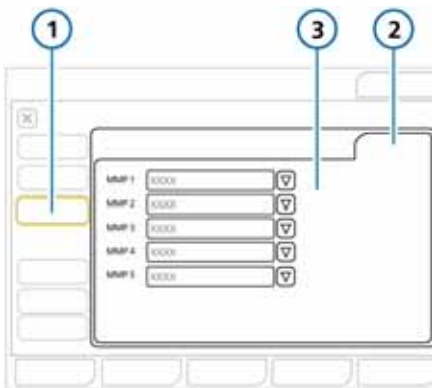

- | | |
|------------|--|
| 1 Graphics | 3 Parameter list for MMP 1 through MMP 5 |
| 2 MMP | |

1.6 Setup window (quick setup configuration)

A *Quick setup* refers to a group of settings you define, including patient characteristics (group and weight), mode selection and control settings, alarm limit settings, and weaning zone limits, that is automatically applied when the setup is selected in the Standby window.

You can configure up to three Quick setups, and can specify a setup to be selected by default when the ventilator is turned on (Section 1.6.2).

1.6.1 Configuring individual setup settings

To configure a Quick setup

1. In Standby mode, configure the ventilator with the parameters you will save as a Quick setup.

Select:

- Patient group and gender/height (adult/pediatric) or weight (neonatal)
- Ventilation mode
- Mode control settings
- Alarm limits

During ventilation you can configure your screen layout and store it to a Quick setup. See Section 6.3.

2. Enter Configuration mode (Section 1.2).
3. In the Configuration window, touch **Setups**, and then touch the button (1, 2, or 3, or your custom-defined labels) for the setup to configure.

Figure I-7 Accessing setup configuration

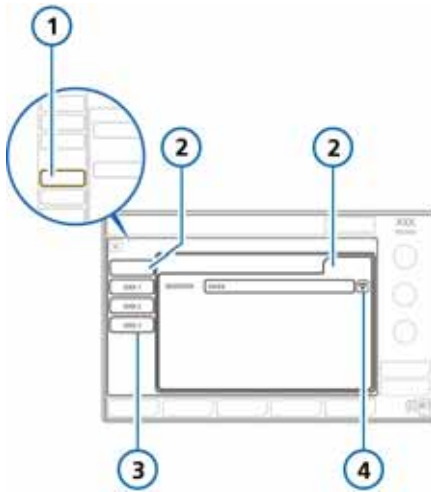

- | | |
|--|------------------------|
| 1 Setups button in main Configuration window | 3 Quick setup buttons |
| 2 Default setup | 4 Select default setup |

The General setup configuration window is displayed (Figure I-8). Note that the buttons in the left panel now change to provide access to the setup options.

4. Touch **Rename setup** to give the setup a meaningful name.

You must define a name, as it is used as the Quick setup button label in Standby, as well as in this configuration window.
5. Select the configuration settings to apply to this setup by touching the appropriate button (Figure I-8):
 - To apply the ventilator settings you selected in step 1, touch **Use current settings**.

- To apply factory settings, touch **Use factory settings**.

Figure I-8 Setup configuration window

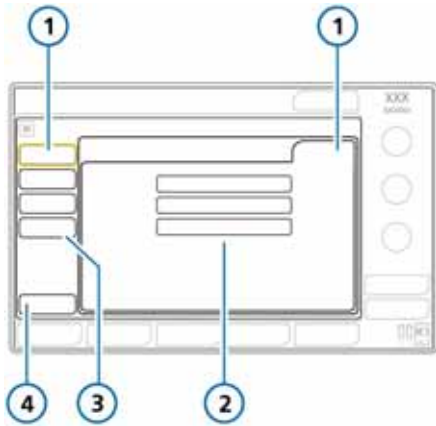

- | | |
|--|--|
| 1 General | 3 Mode Ctrls, Alarms, Vent Status buttons |
| 2 Rename setup, Use current settings, Use factory settings buttons | 4 Back (return to main Configuration window) |

6. Touch **Mode Ctrls > Controls** to review patient parameter settings. Note that the following parameters are not displayed, as they are based on weight:
 - The following parameters are set based on ideal body weight (IBW): **Vt, Rate, T high, T low, and TI**.
 - The following parameters are set based on body weight (neonatal): **Vt, Rate, T low, T high, TI, and TI max**.
7. Touch **Vt/IBW** (or **Vt/Weight** for neonatal) to set the tidal volume per IBW or weight (neonatal). See Figures I-9 and I-10.

The ventilator uses the **Vt/IBW** or **Vt/Weight** (neonatal) setting in calculations for the following:

- To set the initial delivered Vt in volume-controlled modes
- To set the initial high and low alarm limits for Vt and ExpMinVol

Figure I-9 Mode controls configuration

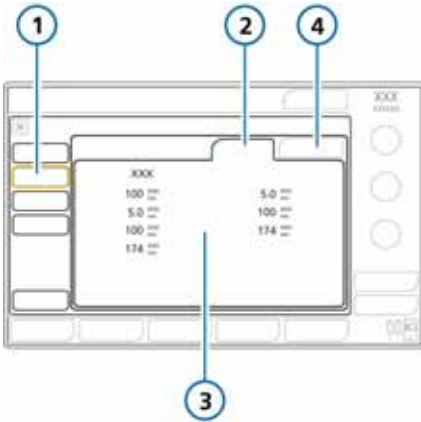

- | | |
|--------------|---------------------------------------|
| 1 Mode Ctrls | 3 Mode and patient parameter settings |
| 2 Controls | 4 Vt/IBW or Vt/Weight (neonatal) |

Figure I-10 Mode controls configuration, Vt/IBW

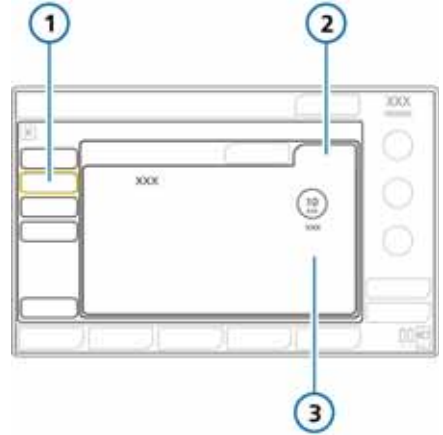

- | | |
|----------------------------------|---|
| 1 Mode Ctrls | 3 Mode and Vt/IBW or Vt/Weight (neonatal) |
| 2 Vt/IBW or Vt/Weight (neonatal) | |

8. Review the alarm settings in the **Alarms** window.

Figure I-11 Reviewing alarm settings

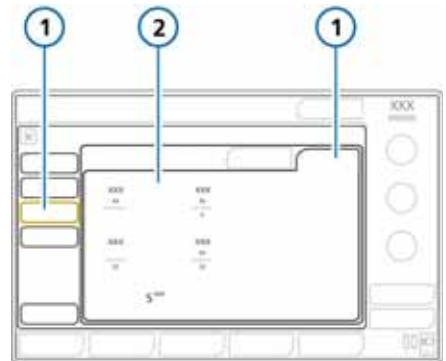

- | | |
|----------|------------------|
| 1 Alarms | 2 Alarm settings |
|----------|------------------|

- In Vent status, set patient parameters manually.

The Vent Status window (Figure I-12) configures the weaning zone ranges of the Vent Status intelligent panel (Figure I-13) according to your institution's protocol.

Figure I-12 Vent Status configuration

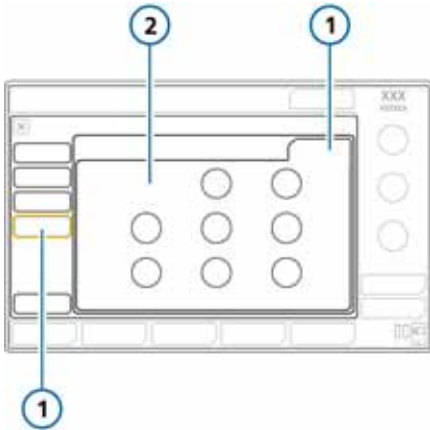

- | | | | |
|---|-------------|---|---|
| 1 | Vent Status | 2 | Parameter weaning-zone settings:
Oxygen, PEEP,
%MinVol, P _{insp} , RSB,
%fspont |
|---|-------------|---|---|

Figure I-13 Vent Status intelligent panel

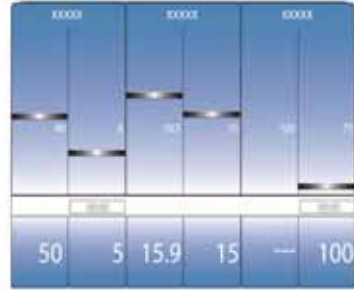

- Touch the **Back** button to return to the Default setup window.

The next time the configured settings will be used by default.

1.6.2 Selecting a default quick setup

A default setup comprises a group of settings that are automatically loaded when turning on the ventilator.

After you have configured one or more quick setups, select the default to use.

To select a default quick setup

- In the Setups window (Section 1.6.1), open the **Default setup** window. See Figure I-7.
- Select the setup to use from the list.

1.6.3 SPO2 and INTELLiVENT configuration options

For SpO₂ and INTELLiVENT configuration options, refer to *Pulse Oximetry Instructions for use* and *INTELLiVENT-ASV Operator's manual*.

1.7 Copying configuration settings to a USB memory device

You can copy the configuration settings to a USB memory device and quickly transfer the settings to other HAMILTON-C3 devices.

NOTICE

- Touch the HAMILTON-C3 before using the USB port.
- If you remove the USB drive before the files are successfully transferred, you must reinitialize the USB port by turning the ventilator off and on again.
- The USB drive must be USB 1.1 compatible.

To copy configuration settings to a memory device

1. Insert a USB drive into the USB port on the side of the ventilator monitor. See Figure 1-6.
2. In the Configuration window, touch the **Transfer** button.
3. In the Transfer window, touch **Import** or **Export** to transfer configuration data with a USB drive.

Figure I-14 Transfer window

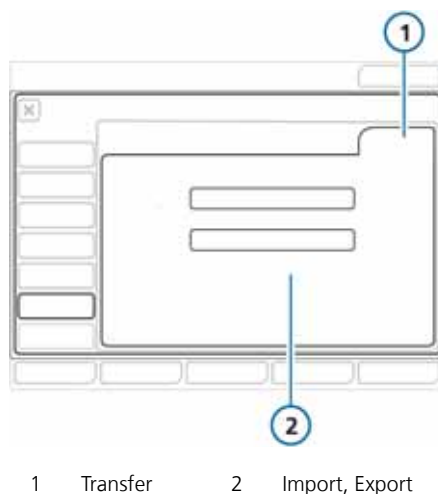

1.8 Configuring software and hardware options

Before use, you must enable any installed hardware (for example, CO₂) options, and add and enable software options.

1.8.1 Reviewing installed options

To view installed options

1. In the Configuration window, touch the **Options** button.
2. Touch the desired tab: **SW options** for software, or **HW options** for hardware. See Figure I-15.
3. Touch the scroll bar to activate it.
4. Turn the P&T knob to scroll up and down through the installed options.
5. Press the knob to deactivate the scroll bar.

1.8.2 Adding software options

Some software options are added using license keys.

Trial versions of software options may be available. Trial options expire and are automatically deactivated after 30 days.

Have available all required keys before proceeding.

To add a software option

1. In Configuration window, touch the **Options** button.
2. In the Options window, touch the **SW options** tab. See Figure I-15.

Figure I-15 SW options tab

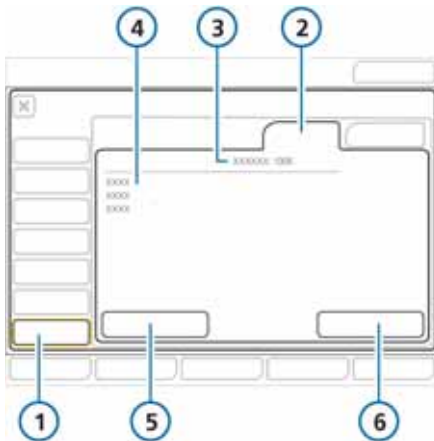

- | | |
|-----------------|---------------------|
| 1 Options | 4 Installed options |
| 2 SW options | 5 Add options |
| 3 Serial number | 6 Clear options |

3. Touch the **Add options** button.

Figure I-16 Add options window

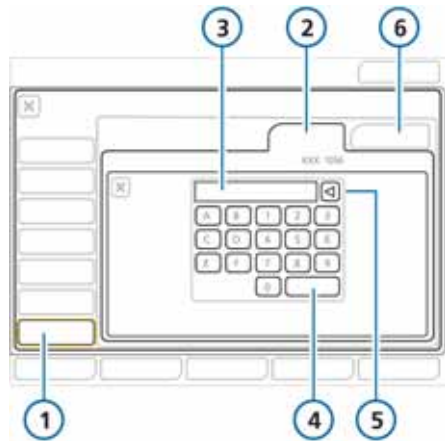

- | | |
|----------------------------------|--------------|
| 1 Options | 4 Enter |
| 2 SW options | 5 Delete |
| 3 Text field to type license key | 6 HW options |

4. Type the activation code exactly as provided into the field and touch **Enter**.

If the message *Option code invalid* appears, re-enter the code. The message *Option valid* indicates the code is correct and the option has been added.

5. Repeat until all desired software options are added.
6. Touch the **X** to close the window.
7. Restart the ventilator to enable the options.

Upon turning on the ventilator, the added options are available for use.

1.8.3 Enabling hardware options

Option board-related functions (CO2) are enabled at two levels:

- The hardware itself must be enabled in configuration to make the functionality available to the user. This section describes this procedure.
- Sensors that plug into the hardware are individually enabled by the user, as needed, in the System window. See Section 3.3.3.

Figure I-17 Hardware options

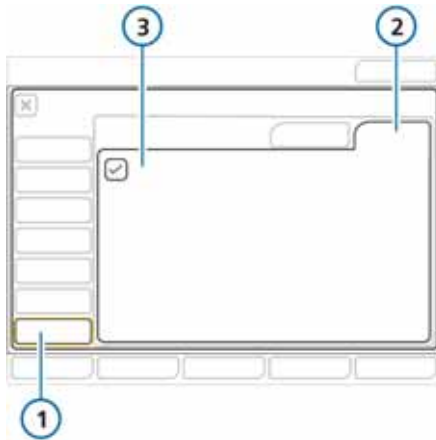

- | | |
|--------------|---------------------|
| 1 Options | 3 Available options |
| 2 HW options | |

To enable hardware options in configuration

1. Touch **Options**.
2. In the Options window, touch the **HW options** tab. See Figure I-17.

The window lists installed hardware that requires activation.

3. Select the check box for options to enable.

Upon exiting configuration, the enabled hardware is available for use.

1.8.4 Removing options

NOTICE

- The **Clear options** function removes *all* non-trial options. You cannot remove just one or a few. If that is your goal, clear the options and re-add those that are needed.
- The patient groups on the ventilator, Adult/Ped and Neonatal, are both treated as options. Clearing options also removes these patient groups and the associated ventilation modes.
- Before the ventilator can be used on a patient, the required patient groups (and associated modes) must be re-added. Follow the steps to add options (Section 1.8.2) and add the necessary patient groups. The associated ventilation modes are also added.
- Options are removed after restarting the ventilator.

To remove software options

You can remove all non-trial software options from the ventilator.

1. In the SW options window, touch **Clear options**.
You are prompted to confirm deletion of all non-trial options, including the Adult/Ped and/or Neonatal patient groups. See Note above.
2. Touch **Clear options** to remove the options.
Touch **Cancel** to leave the options installed.

3. Restart the ventilator.

Once you restart the ventilator, all options (including patient groups) listed in the window are cleared.

4. To re-add the patient groups and any other desired options, re-enter Configuration mode.

5. Add the required patient groups and any desired options, as appropriate. See Section I.8.2.

I.8.4.1 Disabling hardware options

In the HW options window, clear the check boxes for the hardware to disable. See Section I.8.3.

Glossary

A	Ampere, a unit of current.
AC	Alternating current.
alarm buffer	Contains information on the four most recent alarm occurrences.
alarm lamp	Lamp atop the ventilator that lights in a color corresponding to the active alarm.
Alarm silence key	Silences alarm sound for 2 min.
ambient state	An emergency state in which the ventilator opens the inspiratory channel and expiratory valve. This lets the patient breathe room air unassisted by the ventilator.
apnea	Cessation of breathing.
Apnea time	The maximum time allowed without a breath trigger, an alarm setting.
APRV	Airway Pressure Release Ventilation.
APVcmv	Adaptive pressure ventilation with controlled mandatory ventilation. Also labeled (S)CMV+.
APVsimv	Adaptive pressure ventilation with synchronized intermittent mandatory ventilation. Also labeled SIMV+.
ASV target graphics panel	ASV graphical data representation, an Intelligent Panel.
ASV monitored data window	ASV numeric patient data, an Intelligent Panel.
ATP	Ambient temperature and pressure.
ATPD	Ambient temperature and pressure, dry.
AutoPEEP	Unintended positive end-expiratory pressure, a monitored parameter.
Backup	Apnea backup ventilation.
backup buzzer	The buzzer designed to sound for at least 2 min as a backup to the alarm speaker.
base flow	A continuous and constant gas flow from the inspiratory outlet to the expiratory outlet.
b/min	Breaths per minute.
breathing circuit	Includes the inspiratory-expiratory tubing, humidifier, filters, and water traps.
bronchial tree	A part of the Dynamic Lung that shows resistance.
BTPS	Body temperature, barometric pressure at sea level, saturated with water vapor.
C	Compliance.
CE	A certification mark that indicates compliance with the Medical Device Directive, 93/42/EEC.
cm	Centimeter, a unit of length.

cmH2O	Centimeters of water, a unit of pressure. 1 cmH2O is approximately equal to 1 mbar, which equals 1 hPa.
CMV	Controlled mandatory ventilation.
COPD	Chronic obstructive pulmonary disease.
CPAP	Continuous positive airway pressure.
CSA	Canadian Standards Association.
Cstat	Static compliance, a monitored parameter.
DC	Direct current
dB(A)	Decibel, a unit of acoustic power.
DISS	Diameter index safety standard, a standard for high-pressure gas inlet fittings.
DuoPAP	Duo Positive Airway Pressure.
Dynamic Lung	An Intelligent Panel that graphically represents tidal volume, lung compliance, patient triggering, and resistance in real time.
E	Exhalation.
EMC	Electromagnetic compatibility.
EMI	Electromagnetic interference.
EN	European Norm, a European standard.
ET	Endotracheal.
ETO	Ethylene oxide.
ETS	Expiratory trigger sensitivity, a control setting.
event log	A record of clinically relevant ventilator occurrences, including alarms, setting changes, calibrations, maneuvers, and special functions since the ventilator was powered on.
Exp Flow	Peak expiratory flow, a monitored parameter.
ExpMinVol	Expiratory minute volume, a monitored parameter and alarm setting. In the Vent Status panel, ExpMinVol is the percentage of normal minute ventilation, based on IBW.
f	Respiratory rate.
fControl	Mandatory breath frequency, a monitored parameter. It is displayed in monitored data window.
FiO2	Fraction of inspired oxygen.
fSpont	Spontaneous breathing frequency, a monitored parameter.
fTotal	Total breathing frequency, a monitored parameter and alarm setting.
ft	Foot, a unit of length.
Gender	Sex of patient, a control setting.
HEPA	High efficiency particle air filter.

HME, HMEF	Heat and moisture exchanger (artificial nose), heat and moisture exchanging filter
hPa	Hectopascal, a unit of pressure. 1 hPa is equal to 1 mbar, which is approximately equal to 1 cmH ₂ O.
HPO	High-pressure oxygen.
Hz	Hertz, or cycles per second, a unit of frequency.
I	Inspiration.
IBW	Ideal body weight.
ICU	Intensive care unit.
ID	Inner diameter.
IEC	International Electrotechnical Commission.
I:E	Inspiratory:expiratory ratio, a setting, timing parameter, and monitored parameter. Ratio of inspiratory time to expiratory time.
in	Inch, a unit of length.
Insp Flow	Peak inspiratory flow, a monitored parameter.
inspiratory hold	A respiratory maneuver in which gas is retained in the patient's airways, often for X-raying purposes.
Intelligent Panel	A type of graphic display on the ventilator. The Intelligent Panels include the Dynamic Lung, Vent Status, ASV target graphics panel, and ASV monitored data window panels.
IntelliTrig	Intelligent trigger, a feature that ensures that the set trigger sensitivity can trigger a breath independent from leakage and breath pattern.
IRV	Inverse ratio ventilation
ISO	International Organization for Standardization, a worldwide federation of national standards bodies.
kg	Kilogram, a unit of mass.
kPa	Kilopascal, a unit of pressure.
l	Liter, a unit of volume.
l/min	Liters per minute, a unit of flow.
lb	Pound, a unit of weight.
Loops	Special graphic type.
Loudness	Sets the volume for the audible ventilator alarms.
LPO	Low-pressure oxygen.
LSF	Least squares fitting, a mathematical procedure for finding the best fitting curve to a given set of points by minimizing the sum of the squares of the offsets of the points from the curve.
m	Meter, a unit of length.

mandatory breath	A breath for which either the timing or size is controlled by the ventilator. That is, the machine triggers and/or cycles the breath.
manual breath	A user-triggered mandatory breath started by pressing the manual breath key.
%MinVol	Percentage of minute ventilation, a control setting in ASV mode.
MinVol	Minute volume, a calculated and monitored parameter used in ASV mode. Based on the operator-set %MinVol, the ventilator calculates the target MinVol in l/min, then measures and displays it in the ASV target graphics panel.
ml	Milliliter, a unit of volume.
ms	Millisecond, a unit of time.
MVLeak	Total minute volume leakage. MVLeak shows VLeak * frequency (breath rate).
MVSpont	Spontaneous expiratory minute volume, a monitored parameter.
nCPAP-PS	A neonatal mode that offers nasal continuous positive airway pressure - pressure support through a nasal interface (mask or prongs) for infants and neonates.
NIST	Noninterchangeable screw thread, a standard for high-pressure gas inlet fittings.
NIV	Noninvasive ventilation, a ventilation mode.
NIV-ST	Spontaneous/timed noninvasive ventilation, a ventilation mode.
NPPV	Noninvasive positive pressure ventilation.
O2	Oxygen.
Oxygen	Oxygen concentration of the delivered gas, a control setting, monitored parameter, and, in LPO mode, an alarm setting.
P&T knob	Press-and-turn knob. Used to navigate the display, select list items, activate controls and set values.
Pasvlimit	Maximum pressure to be applied in ASV, a control setting.
Pat. height	A control setting. It is used to compute the patient's ideal body weight (IBW) in calculations for ASV and start-up settings.
Paw	Airway pressure.
Pcontrol	Pressure control, a control setting in PCV+ mode. Pressure (additional to PEEP/CPAP) to be applied during the inspiratory phase.
PCV+	Pressure controlled ventilation
PDMS	Patient data management system
PEEP/CPAP	PEEP (positive end-expiratory pressure) and CPAP (continuous positive airway pressure), a control setting and monitored parameter. PEEP and CPAP are constant pressures applied during both the inspiratory and expiratory phases.

P high	High pressure in APRV and DuoPAP mode
Pinsp	Inspiratory pressure, the target pressure (additional to PEEP/CPAP) to be applied during the inspiratory phase. It is operator-set in the PSIMV+ and NIV-ST and a displayed parameter in the Vent Status panel and the ASV target graphics panel.
P low	Low pressure in APRV mode
Pmax	High pressure alarm limit
Press-and-turn knob	Also called <i>P&T knob</i> . Used to navigate the display, select list items, activate controls and set values.
Pressure	Maximum pressure allowed in the patient breathing circuit, an alarm setting.
Pmean	Mean airway pressure, a monitored parameter.
PN	Part number.
Ppeak	Peak airway pressure, a monitored parameter.
Pplateau	Plateau or end-inspiratory pressure. The pressure measured proximally at the last 200 ml of inspiration when flow is or is close to zero.
P-ramp	Pressure ramp, a control setting. The time required for the inspiratory pressure to rise to the set (target) pressure.
pressure control	Maintenance of a consistent transrespiratory pressure waveform despite changing respiratory system mechanics.
Pressure trigger	The patient's inspiratory effort that causes the ventilator to deliver a breath, a control setting.
psi	Pounds per square inch, a unit of pressure.
PSIMV+	Pressure-controlled synchronized intermittent mandatory ventilation mode.
Psupport	Pressure support, a control setting valid during spontaneous breaths in SPONT, SIMV+, and NIV modes. Psupport is pressure (additional to PEEP/CPAP) to be applied during the inspiratory phase.
PSync	Applies same pressures for spontaneous and controlled breaths. Allows the patient to breath spontaneous if he is able to keep the user set guaranteed rate. Formerly called IntelliSync.
Rate	Breath frequency or number of breaths per minute, a control setting.
RCexp	Expiratory time constant, a monitored parameter.
Rinsp	Inspiratory flow resistance, a monitored parameter.
s	Second, a unit of time.
safety mode	An emergency state that ensures a basic minute ventilation while giving the user time for corrective actions in case of some technical fault alarms. The default inspiratory pressure is maintained, the expiratory valve opens as needed to switch system pressure levels between PEEP and inspiratory pressure, and patient sensing is nonfunctional.

(S)CMV+	See APVcmv.
sigh	Breaths delivered to deliberately increase tidal volume at a regular interval. If enabled, a sigh breath is delivered every 50 breaths with an additional 10 cmH ₂ O.
SIMV+	See APVsimv.
SPONT	Spontaneous (pressure support) mode of ventilation.
spontaneous breath	A breath for which both the timing and size are controlled by the patient. That is, the patient both triggers and cycles the breath.
standby	The ventilator is in a waiting state, during which time there is no breath delivery.
STPD	Standard temperature and pressure, dry. Defined as dry gas at 0°C (32°F) at 758 mmHg (101 kPa) pressure at sea level.
TE	Expiratory time, a monitored parameter.
technical fault	A type of alarm, resulting because HAMILTON-C3's ability to ventilate safely is questionable.
TF	Technical fault.
T high	Maximum time in APRV and DuoPAP mode
TI	Inspiratory time, a control setting and monitored parameter.
TI max	Maximum inspiratory time, a control setting in NIV and NIV-ST modes.
timv	SIMV breath interval.
trigger	The patient's inspiratory effort that causes the ventilator to deliver a breath, a control setting. Can be a flow trigger or a pressure trigger.
Ttrigger	Trigger window in SIMV modes.
T low	Minimum time in APRV mode.
Trends	Special graphic type.
V	Volt, a unit of electric potential or volume.
VA	Volt-ampere, a unit of electric power.
VDaw	Airway dead space.
ventilator breathing system (VBS)	A breathing system bounded by the low-pressure gas input port(s), the gas intake port(s), and the patient connection port, together with the fresh-gas inlet and exhaust port(s), if fresh-gas inlet or exhaust ports are provided, as described in ISO 4135.
Vent Status panel	An Intelligent Panel that visualizes six parameters related to the patient's ventilator dependency, including oxygenation and patient activity.
VLBW	Very Low Birth Weight
VLeak	Leakage percent, a monitored parameter.
Vt	Tidal volume, a control setting, an alarm setting and a monitored parameter in the Vent Status panel.

VTE	Expiratory tidal volume, a monitored parameter. It is the integral of all negative flow measurements during exhalation.
VTI	Inpiratory tidal volume, a monitored parameter.

Symbols

- (S)CMV+ mode 218, 240, 241
 - selecting naming convention for 326, 327
- %fSpont
 - (Vent Status) definition 147
 - (Vent Status) range and default 228
- %MinVol (% minute volume)
 - (Vent Status) definition 147
 - (Vent Status) ranges and defaults 228
 - definition 93
 - ranges, accuracy 213

A

Accessories

- about 26
- list of 307, 308

Aerogen Pro nebulizer 54

Airway pressure, mean. *See* Pmean

Alarm silence key 177

Alarms

- Alarm silence key, description 177
- buffer, contents of 155
- buffer, viewing 155
- defaults settings for each 224
- lamp on top of ventilator, about 27
- list of 158
- loudness, adjusting 100
- priorities of each 224
- ranges for each 224
- responding to 170, 171
- sending to remote device 322
- setting 99
- silencing 177
- tests to ensure proper functioning 74
- troubleshooting 158
- viewing 155
- viewing active and inactive 155
- volume (loudness), adjusting 100
- volume (loudness), setting minimum 325
- with ASV, setting 280

Alarms, adjustable

- Apnea 102
- Apnea time 224
- ExpMinVol 102, 224
- fTotal 102, 224
- in neonatal ventilation 117
- Oxygen 102, 224
- PetCO₂ 102
- Pressure 102, 225
- Pressure limitation 225
- Vt 103, 226

Alarms. *See entries for individual alarms*

Ambient state, about 273

Apnea alarms

- Apnea 158
- Apnea time 102, 224
- Apnea ventilation 158
- Apnea ventilation ended 158
- troubleshooting 158

Apnea backup ventilation

- about 88, 93
- ranges, accuracy 213

APRV mode 218, 241

APVcmv mode 240, 241

- selecting naming convention for 326, 327

APVsimv mode 240

- selecting naming convention for 326, 327

ASV mode 218

- about 282
- alarms 280
- ASV graph 281
- ASV graph, ranges and scales used 223
- Cannot meet the target alarm 158
- clinical workflow chart 278
- dead space compensation 279
- monitoring requirements 279, 280
- target graphics window 148, 280
- weaning 282

AutoPEEP

- definition 133
- ranges, accuracy 219

B

Backup ventilation. *See* Apnea backup ventilation

Bacteria filter, connecting 42

Base flow, specifications 230

Batteries

- about 54
- replacing 202
- specifications 211

Battery alarms

- Battery calibration required 158
- Battery communication error 159
- Battery low 159
- Battery power loss 159
- Battery replacement required 159
- Battery temperature high 160
- Battery totally discharged 160
- Loss of external power 167
- Wrong battery 160

Blower fault alarm 160

Blower service required alarm 160

Breath timing options, selecting for PCV+ and (S)CMV+ modes 242, 326

Breathing circuits

- Adult/ped, coaxial with HMEF/HME 46
- Adult/ped, coaxial with mask 46
- Adult/ped, dual limb with humidifier 45
- bacteria filter, connecting 42
- by patient group (neo) 108
- components (neo) 108
- connecting (adult/ped) 41
- HMEF/HME, connecting 42
- Neonatal 108, 112
- Neonatal, dual-limb with HMEF/HME 111
- Neonatal, dual-limb with humidifier 110
- specifications 229

Buzzer defective alarm 160

C

Calibrating 66

- CO2 sensor 70
- flow sensor (adult/ped) 68
- flow sensor (neo) 114
- oxygen cell 69

Cannot meet the target (ASV) alarm 158

Check flow sensor alarm 161

Check flow sensor tubing alarm 161

Check patient interface alarm 161

Check settings alarm 161

Circuits. *See* Breathing circuits

CO2 alarms

- Check CO2 sensor airway adapter 161
- Check CO2 sensor sampling line 161
- CO2 sensor calibration needed 162
- CO2 sensor defect 162
- CO2 sensor disconnected 162
- CO2 sensor over temperature 163
- PetCO2 high 169
- PetCO2 low 169

CO2 measurement

- CO2 sensor, calibrating 70
- enabling/disabling 71
- mainstream sensor, connecting 50
- mainstream, about 50
- sidestream sensor, connecting 52
- sidestream, about 52

CO2 sensor warmup alarm 163

CO2 sensors. *See* CO2 measurement

CO2-related parameters

- FetCO2, definition 134

Communications interface

- about 315
- connecting to computer, PDMS 320
- connecting to patient monitor 318
- Nurse call connector, about 321
- protocols, about 316
- RS-232, about 318
- sending data and alarms to remote device 322

Compensate (TRC)

- definition 97

Compliance. *See* Cstat

Configuration

- accessing Configuration mode 324
- alarm volume (loudness), setting minimum 325
- copying configuration to other ventilators (via USB) 331
- default settings 227
- initial/default ventilator settings, configuring 323

- language, selecting 324
- quick setup settings, configuring 327
- quick setup settings, selecting default 330
- specifications 227
- units of measure, setting 325
- vent status panel settings, configuring 330
- weaning zone ranges, configuring 330
- See also* Software options

Connecting to other devices, about 315

Control settings

- accuracy of measurements 212
- default settings 212
- defined 93
- list of 92
- ranges 212
- setting 85

Cstat (compliance)

- definition 133
- in Dynamic Lung panel 145
- ranges, accuracy 221

Curves. *See* Waveforms

D

Date and time, setting 73

Day and Night display brightness setting 72

Device temperature high alarm 163

Disconnection alarms

- Disconnection on patient side 163
- Disconnection on ventilator side 163

Display, locking the touch screen 182

document conventions 5

DuoPAP mode 218, 241

Dynamic Lung panel

- about 144
- compliance (Cstat), about 145
- displaying 144
- illustrated 144
- patient triggering, illustrated 145
- resistance (Rinsp), about 146
- tidal volume (Vt), about 145

E

Electrical specifications 211

End-expiratory pause pressure. *See* Pplateau

Environmental specifications 209

ETS (expiratory trigger sensitivity)

- definition 93, 117
- ranges, accuracy 213

Event log

- about 157
- copying to USB device 73

Exhalation obstructed alarm 164

Exp flow (peak expiratory flow)

- definition 133
- ranges, accuracy 220

Expiratory filter, using 42

Expiratory flow. *See* Exp flow

Expiratory minute volume. *See* ExpMinVol

Expiratory tidal volume. *See* VTE

Expiratory time constant. *See* RCexp

Expiratory time. *See* TE

Expiratory trigger sensitivity. *See* ETS

Expiratory valves

- installing (adult/ped) 44

ExpMinVol (expiratory minute volume)

- definition 118
- ranges, accuracy 220

ExpMinVol alarms

- definition 102
- ranges and defaults 224

ExpMinVol/MinVol NIV (expiratory minute volume)

- definition 133
- ranges, accuracy 220

External flow sensor failed alarm 164

F

Fan failure alarm 164

fControl (mandatory breath rate)

- definition 133
- ranges, accuracy 220

FetCO2

- definition 134, 301
- ranges, accuracy 221

Filter

- air intake (dust and HEPA), cleaning and replacing 201
- expiratory, using 42
- fan, cleaning and replacing 201
- inspiratory
 - particle size and efficiency 229

Flow

- definition 93

Flow pattern

- definition 93

Flow sensor alarms

- Check flow sensor 161
- Check flow sensor tubing 161
- External flow sensor failed 164
- Flow sensor calibration required 164
- Turn flow sensor 172
- Wrong flow sensor 173

Flow sensors

- about 25
- calibrating (adult/ped) 68
- calibrating (neo) 114
- connecting (neo) 113
- installing (adult/ped) 48
- installing (neo) 113
- installing (neonatal) 113

Flow trigger

- ranges, accuracy 213

flow trigger

- selecting 87

Frequency

- mandatory breath. *See* fControl
- spontaneous breath. *See* fSpont
- total breath. *See* fTotal
- See also* Rate

fSpont (spontaneous breath frequency)

- definition 134
- ranges, accuracy 220

fTotal (total respiratory rate)

- alarms 102, 224
- definition 134
- ranges, accuracy 220

Function key not operational alarm 164

Function test. *See* Preoperational check

G

Gas mixing system, specifications 210

Gas source

- source type (HPO, LPO), selecting 58
- window, about 58

Gas supply

- connecting 56
- See also* Oxygen supply

Gender (sex) parameter, definition 93

Graphics

- ASV Graph 129
- available graphical views of data 124
- Dynamic Lung 129
- Loops 131
- pressure/time graph, illustrated 125
- trends 130
- Vent Status 129
- waveforms 124, 126

H

High Flow O2 therapy

- using 83

High frequency alarm 165

High minute volume alarm 165

High oxygen alarm 165

High PEEP alarm 165

High PetCO2 alarm 169

High pressure alarm 102, 166

High pressure during sigh alarm 166

High PVI alarm 166

High tidal volume alarm 172

HMEF/HME, connecting 42

Humidifiers

- connecting 41
- supported 310

I

I:E (inspiratory/expiratory ratio)

- definition 93, 134
- ranges, accuracy 213, 220
- selecting as timing option for PCV+ and (S)CMV+ modes 242, 326
- timing signals, sending to remote device

322

IBW (ideal body weight)
definition 79
ranges, accuracy 221

Insp flow (peak inspiratory flow)
definition 134
ranges, accuracy 219

Inspiratory flow resistance. *See* Rinsp

Inspiratory hold
performing 179, 180
See also Manual breath

Inspiratory tidal volume. *See* VTI

Inspiratory time, monitored parameter. *See* TI

Inspiratory volume limitation alarm 166

Intelligent panels
ASV Graph 148, 281
Dynamic Lung 144
Vent Status 146

IntelliTrig (intelligent trigger) function 296

Intrinsic PEEP. *See* AutoPEEP

Invalid option board alarm 166

IRV alarm 166

K

Keys on front panel
about 176
Alarm silence 177
Manual breath 179, 180
Nebulizer 181
O2 enrichment 178
Power/Standby 176
Print screen 182
Screen Lock/unlock 182

L

Language, selecting 324

Loops
about 131
displaying 132
ranges and scales used 223
storing 132

Loss of external power alarm 167

Loss of PEEP alarm 167

Loudness for alarms

setting 100
setting minimum for 325
specifications 232

Loudspeaker defective alarm 167

Low frequency alarm 167

Low minute volume alarm 167

Low oxygen alarm 167

Low PetCO2 alarm 169

Low pressure alarm 102, 168

Low tidal volume alarm 173

M

Main monitoring parameters (MMP)
about 121
configuring which to display 327
viewing 121
where displayed 34

Maintenance 195

Mandatory breath rate. *See* fControl

Manual breath
delivering 179
key, about 28

Maximum inspiratory time. *See* TI max

Maximum pressure alarm. *See* Pressure

Mean airway pressure. *See* Pmean

Minute volume setting. *See* %MinVol

MinVol NIV
ranges, accuracy 220
See also %MinVol

MMP. *See* Main monitoring parameters

Modes, ventilation
controls active in 218
default selection 213
selecting 82
specifying control settings 85
supported 213
See also Ventilation modes

Monitored parameters
accuracy of measurements 219
default settings 219
definitions 133
list of 132
ranges 219
viewing 121

See also name of specific parameter

Monitoring windows, accessing 121

MVLeak (leakage)

definition 139

ranges, accuracy 220

MVSpont/MVSpont NIV (spontaneous minute volume)

definition 134

ranges, accuracy 220

N

nCPAP-PS mode 218, 241

Nebulizer

connecting 54

nebulization, starting/stopping 182

Nebulizer key 181

Neonatal ventilation 105

adjustable alarms in 117

breathing circuit, setting up 108

parameters used in 116

patient group, selecting 107

patient group, selecting neonatal 107

setting up for 106

ventilation mode, selecting 108

ventilation modes for 116

NIV mode 218, 241

NIV-ST mode 218, 241

Noninvasive ventilation (NIV)

adverse reactions 294

alarms 295

benefits of 292

checking mask fit and position 296

CO₂ rebreathing 297

contraindications 293

maintaining PEEP and preventing autotriggering 296

monitored parameters 295

required conditions for use 293

selecting a patient interface 294

Numeric patient data, how to view 121

Nurse call connector

about 321

sending data and alarms to remote devices 322

O

O₂ cell alarms

O₂ cell calibration needed 168

O₂ cell defective 168

O₂ cell missing 168

O₂ cell not system compatible 168

Operating hours, versions, options, and versions, how to view 66

Options not found alarm 168

Oxygen

(Vent Status) definition 147

(Vent Status) range and default 228

definition 93, 135

ranges, accuracy 213, 221

Oxygen (O₂) enrichment

about (adult/ped) 178

for neonates 118

O₂ enrichment key 178

starting/stopping 178

Oxygen cell

calibrating 69

replacing 204

Oxygen monitoring, enabling/disabling 71

Oxygen supply

connecting 56, 57

source type (HPO, LPO), selecting 58

Oxygen-related alarms

definition 102

High oxygen 165

Low oxygen 167

Oxygen supply failed 169

ranges and defaults 224

P

P high (high pressure setting)

(APRV) ranges, accuracy 214

(DuoPAP) ranges, accuracy 214

definition 94

P low (low pressure setting APRV)

definition 94

ranges, accuracy 214

P0.1 (airway occlusion pressure)

definition 135

ranges, accuracy 221

Parameters, control. *See* Control settings

-
- Parameters, monitored, list of 132
 - parts, list of 307
 - Pasvlimit (ASV pressure limit)
 - definition 94
 - ranges, accuracy 214
 - Pat. height (patient height)
 - definition 94
 - ranges, accuracy 214
 - Patient groups
 - about 78
 - selecting 79, 107
 - Patient monitor, connecting to 318
 - Patient synchronization 296
 - Pause
 - definition 94
 - Pause (end-expiratory) pressure. *See* Pplateau
 - PC, connecting to 320
 - Pcontrol (pressure control)
 - definition 94
 - ranges, accuracy 214
 - PCV+ mode 218, 241
 - PDMS, connecting to 320
 - Peak expiratory flow. *See* Exp flow
 - Peak flow
 - definition 94
 - Peak inspiratory flow. *See* Insp flow
 - Peak proximal airway pressure. *See* Ppeak
 - PEEP/CPAP
 - (Vent Status) definition 147
 - (Vent Status) range and default 228
 - definition 94, 135
 - ranges, accuracy 214, 219
 - Performance limited by high altitude alarm 169
 - PetCO₂
 - definition 301
 - ranges, accuracy 221
 - PetCO₂ alarms 102
 - Piezo nebulizer, use of 54
 - Pinsp (inspiratory pressure)
 - (Vent Status), definition 147
 - (Vent Status), range and default 228
 - definition 136
 - ranges, accuracy 214, 219
 - Plateau pressure. *See* Pplateau
 - Pmean (mean airway pressure)
 - definition 136
 - ranges, accuracy 219
 - Power source
 - AC, connecting to 54
 - batteries, about 54
 - batteries, calibrating/charging 202
 - batteries, replacing 202
 - connecting to 54
 - DC, connecting to 54
 - DC, power cables supported 54
 - specifications 211
 - symbols used on device 55
 - Power/standby key 176
 - Ppeak (peak proximal airway pressure)
 - definition 136
 - ranges, accuracy 219
 - Pplateau (plateau pressure)
 - definition 136
 - ranges, accuracy 219
 - P-ramp (pressure ramp)
 - definition 95, 117
 - ranges, accuracy 214
 - Preoperational check
 - performing (adult/ped) 64
 - performing (neo) 115
 - Press-and-turn (P&T) knob, description 29
 - Pressure control setting. *See* Pcontrol
 - Pressure ramp. *See* P-ramp
 - Pressure support setting. *See* Psupport
 - Pressure trigger
 - accuracy 215
 - pressure trigger (p trigger)
 - selecting 87
 - Pressure. *See name of specific pressure*
 - Pressure/time waveform, about 124
 - Pressure-related alarms
 - High and low alarm ranges and defaults 225
 - High pressure 166
 - High pressure during sigh 166
 - Loss of PEEP 167
 - Low pressure 168
 - Performance limited by high altitude 169
 - Pressure limit has changed 169
 - Pressure limitation 169
-

- Pressure limitation alarm ranges and defaults 225
- Pressure not released 169
- Preventive maintenance required alarm 170
- Print screen key 182
- Protocols, communication with other devices, about 316
- PSIMV+ mode 218, 241
- PSIMV+ PSync 218
- Psupport (pressure support)
 - definition 95
 - ranges, accuracy 215
- PTP (inspiratory pressure time product)
 - definition 137
 - ranges, accuracy 221

Q

- Quick setup settings
 - configuring 327
 - default, selecting 330
 - using to select basic ventilation options 78

R

- Rate (respiratory frequency)
 - definition 95
 - mandatory breath. *See* fControl
 - ranges, accuracy 215
 - spontaneous breath. *See* fSpont
 - total respiratory. *See* fTotal
- Rate-related alarms
 - High frequency 165
 - Low frequency 167
- RCexp (expiratory time constant)
 - definition 137
 - ranges, accuracy 221
- Real time clock failure alarm 170
- Release valve defective alarm 170
- Replace HEPA filter alarm 170
- Replace O2 cell alarm 170
- Resistance, inspiratory flow. *See* Rinsp
- Rinsp (inspiratory flow resistance)
 - definition 138
 - display in Dynamic Lung 146

- ranges, accuracy 221
- RS-232 connector, using to send data 318
- RSB
 - (Vent Status) definition 147
 - (Vent Status) range and default 228
- RTC failure alarm 170

S

- Safety therapy alarm 171
- Safety ventilation alarm 170
- Screen Lock/unlock key 182
- Screenshots, capturing. *See* Print screen key
- Self test failed 171
- Sensor fail mode alarm 171
- Sensors on/off function 71
- Setup, ventilator 62
- Sidestream CO2 sensor
 - about 52
 - connecting 52
 - See also* CO2 measurement
- Sigh
 - definition 96
 - ranges, accuracy 215
 - setting 85
- Silencing alarms 177
- SIMV+ mode 218, 240
 - selecting naming convention for 326, 327
- slopeCO2, ranges, accuracy 221
- Software options
 - adding 332
 - enabling 333
 - removing 333
- Specifications
 - accuracy testing 232
 - alarms, settings and ranges, adjustable 224
 - breathing system 229
 - electrical 211
 - environmental 209
 - environmental requirements 209
 - essential performance 232
 - gas mixing system 210
 - inspiratory filter, particle size and efficiency 229

-
- pneumatic 210
 - standards and approvals 233
 - technical performance data 230
 - ventilator dimensions 208
- SPONT mode 218, 241
- Spontaneous breath frequency. *See* fSpont
- Spontaneous minute volume. *See* MVSpont, MVSpont NIV
- Standby
 - about 176
 - entering and exiting 177
 - putting ventilator into 177
- Starting ventilation 177
- Storage, requirements 204
- Suctioning
 - performing 179
- Suctioning maneuver alarm 171
- Symbols, definitions 35
- ## T
- T high
 - (APRV) ranges, accuracy 215
 - (DuoPAP) ranges, accuracy 215
 - definition 97
- T low
 - definition 98
 - ranges, accuracy 216
- TE (expiratory time)
 - definition 138
 - ranges, accuracy 220
- Technical event alarm 171
- Technical fault alarm 171, 273
- Technical state failed alarm 172
- Tests
 - alarm tests 74
 - preoperational checks, performing (adult/ped) 64
 - preoperational checks, performing (neo) 115
- TI (inspiratory time)
 - definition 98, 138
 - ranges, accuracy 215, 220
 - selecting as timing option for PCV+ and (S)CMV+ modes 242, 326
- TI max (maximum inspiratory time)
 - definition 98, 117
 - ranges, accuracy 215
- Tidal volume setting *or* alarm. *See* Vt
- Tightness test
 - performing (adult/ped) 67
 - when to perform 65
- Time constant, expiratory. *See* RCexp
- Time scale
 - changing 126
- Time, expiratory (monitored parameter). *See* TE
- Time, inspiratory (monitored parameter). *See* TI
- Tip
 - definition 98
- Total respiratory rate. *See* fTotal
- Touch not functional alarm 172
- Touch screen, locking the display 182
- Transport
 - preparing trolley for intrahospital transport 59
- TRC
 - about 89
 - control settings, defined 96
 - disabling 90
 - setting 90
 - tube size 97
- TRC expiration
 - definition 97
- Trends
 - about 130
 - displaying 130
- Trigger
 - definition 97
- trigger type
 - changing 87
- Trigger, ranges, accuracy 221
- Trolley
 - patient support arm 59
 - use guidelines 59
- Troubleshooting alarms, what to do 158
- Tube ID (TRC)
 - definition 97
- Turn the Flow Sensor alarm 172
- Turning ventilator on/off 60

U

Ultrasonic nebulizer. *See* Aerogen Pro ultrasonic nebulizer system

Units of measure, setting 325

Unknown part number alarm 172

USB device

copying configuration settings using 331

copying Event log using 73

USB port, location 31

V

V'alv, ranges, accuracy 221

V'CO₂, ranges, accuracy 221

VDaw, ranges, accuracy 221

VDaw/VTE, ranges, accuracy 221

VeCO₂, ranges, accuracy 221

Vent Status panel 146

list of parameters 147

weaning zone ranges, configuring 330

Ventilation canceled alarm 172

Ventilation modes

control settings active in each mode 218

controls, setting 85

default mode 213

naming convention for adaptive modes,
selecting 326, 327

neonatal modes, selecting 108

selecting 82

supported 213

See also Modes, ventilation

Ventilation modes, list of

(S)CMV+ (APVcmv) 240, 241

APRV 241

DuoPAP 241

nCPAP-PS 241

neonatal 116

NIV 241

NIV-ST 241

PCV+ 241

PSIMV+ 241

SIMV+ (APVsimv) 240

SPONT 241

Standby 176

Ventilator

components, illustrated 26

entering and exiting Standby 176

starting ventilation 177

turning on 60

viewing operating hours, options, and ver-
sions 66

Ventilator keys (front panel)

about 176

Alarm silence 177

Manual breath 179, 180

Nebulizer 181

O₂ enrichment 178

Power/standby 176

Print screen 182

Screen Lock/unlock 182

Ventilator outlet temperature high alarm 172

ViCO₂, ranges, accuracy 222

VLeak (leakage)

definition 139

ranges, accuracy 220

Volume

expiratory minute volume. *See* ExpMinVol
expiratory tidal (monitored parameter).

See VTE

inspiratory tidal (monitored parameter).

See VTI

leakage. *See* VLeak

spontaneous minute (monitored parame-
ter). *See* MVSpont, MVSpont
NIV

tidal. *See* Vt

Volume (loudness) for alarms

setting 100

setting minimum 325

specifications 232

Volume-related alarms

High minute volume 165

Low minute volume 167

Vt high 172, 226

Vt low 173, 226

Vt (tidal volume)

definition 98, 118

ranges, accuracy 216

Vt alarms

definition 103

Vt high alarm 172

Vt low alarm 173

VT/kg

- definition 98
- ranges, accuracy 216

Vtalv, ranges, accuracy 221

VTE/VTE NIV

- definition 140
- ranges, accuracy 220

VTEspont (spontaneous exp tidal volume)

- definition 140
- ranges, accuracy 221

VTI (inspiratory tidal volume)

- definition 140
- ranges, accuracy 220

W

Warranty 234

Waveforms

- about 124
- pressure/time, about 124
- ranges and scales used 222
- x-axis, changing of scale 126

Weaning, with ASV mode 282

Weight

- definition 98, 117
- ranges, accuracy 216, 221

Wrong battery alarm 160

Wrong flow sensor alarm 173



Hamilton Medical AG
Via Crusch 8, 7402 Bonaduz, Switzerland
☎ +41 58 610 10 20
✉ info@hamilton-medical.com
www.hamilton-medical.com

HAMILTON
MEDICAL
Intelligent Ventilation since 1983