

3100B
High Frequency Oscillatory Ventilator

Operator's Manual

767164
0601G

Copyright 2001 SensorMedics Corporation
Printed in U.S.A.



3100B High Frequency Oscillatory Ventilator

Revision	Changes	Pages	Date
A	Original Release	All	January 1993
B	Revisions to meet FDA requirements and 3100B device specification changes	All	January 1996
C	Performance Graphs updated Performance Check procedure updated Piston Centering instructions removed Warning re: use in environments >28°C added	2.9–2.12 1.9, 6.5, 6.9 1.9, 2.3, 4.14, 4.15, 6.5, 6.7, 7.13-7.15, 8.2, 8.3 6.7	May 1998
D	Addresses and phone numbers updated Indications for Use and Adverse Effects updated Precautions updated CE Mark information added Tech. Support phone numbers removed P _A Control Valve changed to P _A Adjust Control, P _A Adjust Valve changed to P _A Control Valve Treatment Strategies updated Bias Flow, Frequency, % Inspiratory Time, and Oscillatory Pressure Amplitude strategies updated General Aspects of Clinical Strategy updated Disease-Specific Variations to General Clinical Strategies updated Non Invasive Gas Monitoring recommendations updated Suctioning Guidelines updated	Ad.1 1.2 1.4 2.7 7.9, 7.11 7.16 8.2 8.3, 8.4, 8.5, 8.6 8.6, 8.7, 8.8 8.10 8.11 8.13	October 1998

3100B High Frequency Oscillatory Ventilator

Revision	Changes	Pages	Date
E	Changed page numbering system	All	September 1999
	Alarm levels readjust modified	5	
	Patient Circuit Calibration Procedure Label modified	7	
	Ventilator Performance Checks Label modified	8	
	Mean Pressure Limit specifications modified	13	
	Air Cooling Inlet Flow specifications modified	18, 52	
	3100B HFOV Block Diagram removed	25	
	Mean Pressure Limit instructions removed	27, 43, 68, 84, 86, 87	
	Oscillator Subsystem airflow specifications modified	35	
	Warning Alarms instructions modified	37, 45	
	Set Max P _A Alarm instructions modified	44	
	Patient Circuit Calibration instructions modified	66, 78	
	Ventilator Performance Check instructions modified	67, 68	
	Driver Diaphragm Lubrication procedure added	75	
F	Corrected the company phone number	vii	January 2001
	Indications of Use section—removed the last sentence	1	
	Changed the patient circuit warning	2	
	Replaced the Patient Circuit Calibration Procedure label	7	
	Updated the Driver Replacement Record Label	10	
	Changed the driver-replacement hours to 2000	10	
	Changed the Mean Pressure Limit to “Automatic”	13	
	Updated Figures 2.1 through Figure 2.4	20–23	
	Added Figure 2.5	24	
	Modified figure 3.2 (changed the Y axis from 50 to 60 cm)	31	
	Changed the oscillator system operational life to read “more than 2,000 hours”	32	
	Changed the LPM values in Section F	34	
	Changed the warning alarm description	37	
	Low bias flow rate note added	37	
	Changed the safety alarms description	37-38	
	Modified Figure 4.1	42	
	Removed “Piston Centering” from the fifth paragraph under Mean Pressure Adjustment	43	
Changed the statement describing the affects of changing the “% Inspiratory Control”	45		
Revision	Changes	Pages	Date

3100B High Frequency Oscillatory Ventilator

F (cont.)	Changed the warning alarm description	45	January 2001
	Low Bias Flow Rates note added	46	
	Modified Figure 4.2	50	
	Changed the LPM value in item 27 of Chapter 4	52	
	Modified item 37 of Chapter 4	55	
	Modified item 42 of Chapter 4	56	
	Changed the patient circuit warning	61	
	Modified Figure 5.3	62	
	Changed the patient circuit warning	66	
	Changed step 6a of the "Start-up Procedures"	67	
	Changed steps 7b, 7c, 9, and 10 of the "Start-up Procedures"	68	
	Changed steps 13, 14, 16, and 17 of the "Start-up Procedures"	69	
	Changed steps 18 and 20 of the "Start-up Procedures"	70	
	Changed "Emptying the Water Trap" section	74	
	Changed "Changing the Patient Circuit"	76	
	Changed "Patient Circuit Calibration"	78	
	Changed "F. Scheduled Periodic Maintenance" to indicated "every 2,000 hours" of operation	82	
	Updated the "Visual/Audible Alarm Occurring" table	85	
	Changed the description of part number 771384-102	89	
	Changed the part number 463202 to 770566 and changed its description	90	
	Added part number 765298	90	
	Changed item 3 under "Weaning"	96	
	Removed the first paragraph of Section E	101	
<hr/>			
G	Changed the section "A. Treatment Strategies"	91	June 2001
	Changed "Frequency" and "% Inspiratory Time"	92	
	Added the section "Mean and Range of 3100B Settings"	92	
	Changed "General Aspects of Clinical Strategy"	95	
	Added the section "Oxygenation"	95	
	Changed "Ventilation" and "Weaning"	96	
	Removed "Mean and Range of 3100B Settings" and added "Summary of MOAT II Clinical Management Strategies" and "Summary of Weaning Strategy from MOAT II Clinical Trial"	97	
Revision	Changes	Pages	Date

3100B High Frequency Oscillatory Ventilator

G (cont.)	Removed "Summary of HFOV Therapeutic Intervention and Rationale"	98	June 2001
	Changed "C. Adverse Effects"	99	

3100B High Frequency Oscillatory Ventilator

Manufacturer

SensorMedics Corporation
22705 Savi Ranch Parkway
Yorba Linda, California 92887-4645
Telephone: (800) 231 2466
(714) 283 2228
FAX: (714) 283 8493

Authorized European Representative

SensorMedics BV
Rembrandtlaan 1b
3723 BG Bilthoven
The Netherlands
Telephone: +31 (30) 2289711
FAX: +31 (30) 2286244

On the Internet at www.sensormedics.com.

3100B High Frequency Oscillatory Ventilator

Caution: Federal law restricts this device to sale by, or on the order of a physician.

Caution: Not suitable for use in the presence of flammable anesthetics.

Service of this instrumentation is restricted to factory trained personnel only.

3100B High Frequency Oscillatory Ventilator

1 Introduction 1

 A. Indications for Use..... 1

 B. Contraindications..... 1

 C. Adverse Effects of the Device on Health..... 1

 D. Warnings 1

 E. Precautions 3

 F. Explanation of Symbols 6

 G. Exterior Labels 7

2 Specifications 13

 A. Controls 13

 B. Indicators 14

 C. Pressure Measurement..... 15

 D. Alarms 16

 E. Electrical 17

 F. Pneumatic Connections..... 18

 G. Physical..... 19

 H. Performance..... 20

3 Description of System and Safety Features 25

 A. Introduction..... 25

 B. External Air/O₂ Blender..... 25

 C. External Humidifier..... 25

 D. Pneumatic Logic and Control 27

 Bias Flow 27

 Mean Pressure Adjust 27

 Patient Circuit Calibration 27

 E. Patient Circuit..... 28

 F. Oscillator Subsystem..... 32

 G. Airway Pressure Monitor..... 34

 H. Electronic Control and Alarm Subsystem..... 35

 I. Electrical Power Supply 36

 J. Safety Features..... 37

4 Location and Function of Controls, Indicators, and Connections 41

 A. Introduction..... 41

 B. Front and Side Panel – Control Package 42

 C. Rear Panel – Control Package..... 50

 D. System Column and Patient Circuit 53

3100B High Frequency Oscillatory Ventilator

5 Assembly and Installation 57
A. Introduction..... 57
B. Unpacking 57
C. Assembly..... 57
D. Pre-use Cleaning and Disinfection..... 64

6 Operational Verification and Start-up Procedures 65
A. Introduction..... 65
B. Start-up Procedures 66
C. Performance Verification..... 71

7 Maintenance and Troubleshooting 73
A. Introduction..... 73
B. Exterior Cleaning..... 73
C. Operator Maintenance Procedures 73
 Emptying the Water Trap..... 74
 Changing the Compressed-gas Inlet Filter Cartridge Elements 74
 Changing the Power Failure Alarm Battery 75
 Cleaning the Column Lint Filter 76
 Changing the Patient Circuit..... 76
 Lubrication of the Driver Diaphragm..... 76
D. Patient Circuit Calibration..... 78
E. Other Scheduled Periodic Calibration 78
 Control Package DC Power Supply..... 79
 Airway Pressure Monitor Transducer 81
F. Scheduled Periodic Maintenance 82
G. Troubleshooting 82
 Special Environmental Considerations..... 82
 Electrostatic Discharge..... 82
 Electromagnetic Interference..... 83
 Troubleshooting Chart..... 84
H. Supplies and Replacement Parts..... 89

8 Clinical Guidelines 91
A. Treatment Strategies..... 91
 Adjusting the 3100B’s Controls to Execute the Treatment Strategies..... 91

3100B High Frequency Oscillatory Ventilator

Therapeutic Objectives 95

General Aspects of Clinical Strategy 95

Summary of MOAT II clinical management strategies 97

Summary of weaning strategy from MOAT II Clinical Trail 98

B. Disease-Specific Variations to General Clinical Strategies 98

 Homogeneous Lung Disease Without Significant Air Leak 98

 Non-Homogeneous Lung Disease, Air Leak Syndromes, and Airway Disease 98

C. Adverse Effects 99

D. Recommended Monitoring Frequency 100

 Arterial Blood Gases..... 100

 Non Invasive Blood Gases (tcO₂, tcCO₂, and SpO₂)..... 100

 Chest X-ray..... 100

E. Suctioning Guidelines..... 101

In Index..... 103

A. Indications for Use

A. Indications for Use

The SensorMedics 3100B is indicated for use in the ventilatory support and treatment of selected patients 35 kilograms and greater with acute respiratory failure

B. Contraindications

The SensorMedics 3100B Oscillatory Ventilator has no specific contraindications.

C. Adverse Effects of the Device on Health

In the adult ARDS prospective, non-randomized trial, adverse effects identified were hypotension, and mucus plugging. Significant adverse cardiovascular effects were rare in the 30 patients entered into the study with only one patient exited from the study for hypotension. Only one patient required re-intubation for narrowing of their endotracheal tube by mucus encrustment.

In the pediatric randomized trial of the 3100A ventilator, adverse effects identified were lung overdistention, air leak, and hypotension. There were no statistical differences in any of the adverse effects as compared to those reported in the conventionally treated patients with the exception of hypotension. The HFOV treated group had few but statistically significant more frequent incidences of hypotension however, without evidence of serious compromise of cardiovascular status.

High frequency ventilation, as with conventional positive pressure ventilation, has inherent risks. These possible adverse effects include: under/over ventilation, under/over humidification, chronic obstructive lung disease, necrotizing tracheal bronchitis (NTB), atelectasis, hypotension, pneumothorax, pneumopericardium, pneumomediastinum, pneumoperitoneum, and pulmonary interstitial emphysema (PIE). The reported frequency of these occurrences are similar to conventional ventilation.

D. Warnings

The following Warnings must be read and understood before an attempt is made to operate the Model 3100B HFOV:

D. Warnings

Do not attempt to defeat the proper connection of the ground wire as it may cause damage to the device or interconnected equipment and could be injurious to the patient or to those associated with the device use. This device is factory equipped with a hospital-grade AC power plug. Grounding reliability can only be assured when connected to a tested receptacle labeled "Hospital Grade."

Do not operate radio transmitters within 20 feet of this instrument. This may result in erroneous pressure readings leading to false alarms and automatic shutdown.

Do not shorten the 30" bias flow tube provided with the patient circuit as this may reduce the maximum ΔP by allowing the oscillatory pressures to be attenuated by closer proximity to the volume of the humidifier canister.

Do not attempt to substitute a circuit configuration from any other instrument. Use of a non-3100A or a non-3100B circuit can result in injury to the patient or to the operator, and it may cause damage to the equipment. The Patient Circuit described in this manual is specifically designed for patient use with the Model 3100B HFOV.

Only SensorMedics approved lubricants should be used. Use of any other lubricants could result in damage to the Driver Diaphragm or Bellows Water Trap Membrane causing ventilator failure or patient injury.

The operational verification and startup procedure (Chapter 6) must be followed before ventilation of a patient commences. If at any time during the operational verification and startup procedure any abnormal function of the Model 3100B HFOV is noted, do not proceed with patient ventilation as this could cause patient injury or death; immediately contact SensorMedics Technical Support before proceeding any further.

An audible alarm indicates the existence of a condition potentially harmful to the patient and should not go unattended. Failure to respond to alarms could result in injury (including death) to the patient and/or damage to the ventilator.

Ensure that the cooling fan at the rear of the driver enclosure is operational.

Under no circumstances should the ventilator be used in the presence of flammable anesthetics due to the possibility of explosion.

E. Precautions

Under no circumstances should a proximal airway gas temperature of 41°C be exceeded. This could result in injury to the patient's airway membranes.

Do Not use the 3100B ventilator in environments where the ambient temperature is at or above 84°F (28°C). Use of the ventilator in these environments will result in extreme reduction in relative humidity in the patient's airway and possible desiccation of the patient airways.

Failure to comply with the recommended maintenance procedures described in Chapter 7 could result in injury to the patient or operator or could result in damage to the equipment.

E. Precautions

The following Precautions must be read and understood before an attempt is made to operate the Model 3100B HFOV:

Follow closely the recommendations contained in Chapter 8, Clinical Guidelines, regarding the use of chest radiographs to monitor patient condition. During HFOV, as with all ventilators, the relationship between improvement in lung compliance, inadvertent increases in lung volume, increased pleural pressure, and decreased venous return is a matter of concern, since it may result in decreased cardiac output.

Patient size is an important guideline as to lung volume and anatomical dead space, as well as the metabolic demand placed on ventilation. While the maximum displacement volume of the 3100B is approximately 365 ml, the actual volume delivered to the patient is dependent on power setting, frequency, endotracheal tube size, and patient respiratory system compliance. It is recommended that the operator review Section 8 of this manual, "Clinical Guidelines."

The patient's tcPCO₂ and tcPO₂ or SpO₂ should be monitored continuously to insure that blood gases are at the proper level. It is important that an unrestricted and unobstructed patient airway be maintained during HFOV. To insure a patent airway, always maintain proper suctioning procedures as described in the Suctioning Guidelines Section of Chapter 8, Clinical Guidelines. Since only proximal airway pressure is measured, no alarm will occur in the event of an obstruction or restriction.

E. Precautions

Ensure that the stopcock is closed prior to performing a Patient Circuit Calibration. If the Water Trap Stopcock is left open, Patient Circuit Calibration (39-43 cmH₂O) may not be achievable, and the deliverable P_A will be reduced.

Deviation from the assembly methods described in Chapter 5, Assembly and Installation, could damage the Model 3100B, render it mechanically unstable, or cause it to malfunction. If any questions arise regarding the assembly procedure, please contact SensorMedics Technical Support immediately before proceeding.

Care should be taken not to crimp or perforate any of the control or sensing lines (running to or from the Patient Circuit) during assembly, operating or cleaning of the ventilator as this will cause malfunction of the Safety Alarms, Warning Alarms, Caution Alarms, and/or Pressure Limit Controls.

The driver diaphragm of the 3100B has been coated with a special lubricant during assembly. Please do not clean the driver diaphragm with cleaning solvents as it may degrade the materials causing premature wear of the driver diaphragm.

When connecting the Patient Circuit, make certain that it is properly supported and oriented by the support arm as described in Chapter 5, Assembly and Installation. Failure to do so could result in inadvertent Patient Circuit disconnection due to oscillatory forces or could result in collection of humidifier condensate in the patient airway.

If the temperature probe is wiped with alcohol, allow the alcohol to evaporate completely before inserting it into the circuit. A high residual of alcohol can weaken the acrylic adapter and cause fracturing.

Proper operation of the ventilator must be verified prior to each use. Refer to Chapter 6, Operational Verification and Startup Procedures. The alarm functions tested in this procedure verify the capability of the device to detect and indicate conditions which could have a harmful effect on the patient.

Touch the outer metal cabinet of the instrument before touching any other component to avoid possible instrument component damage from Electrostatic Discharge.

E. Precautions

When the ventilator is connected to a patient, it is imperative that someone be in attendance at all times in order to react to any alarms and to detect other indications of a problem.

The Inlet Filter Cartridges for the blended gas and the air inputs to the ventilator must be changed at least every 500 hours of operation as described in Chapter 7, Maintenance and Troubleshooting. Failure to replace a Filter Cartridge or substitution of an unauthorized cartridge could result in injury to the patient and/or damage to the equipment. Use only SensorMedics Inlet Filter Cartridges.

The filter cartridge body must be screwed back on securely. Cross-threaded or loose installation will result in leaks and possible dislodging of the cartridge body. If the cartridge body is dislodged, it will cause the ventilator to cease functioning.

The cover enclosing the Control Package, Column, or any other portion of the ventilator must not be removed by the user. To avoid electrical shock hazard, please refer all service requiring cover removal to a qualified biomedical equipment service technician.

Recheck and readjust alarm levels after any parameter change has been made.

Troubleshooting with the 3100B should be done "OFF PATIENT" to avoid any potentially dangerous situations such as abrupt changes in the P_A.

Do not use extraneous ventilator circuit attachments (such as a suction port) without a secondary external alarm capable of detecting ventilator disconnection. Due to their inline pressure characteristics, such attachments could possibly keep the P_A alarm from detecting an accidental ventilator circuit disconnection.

Fractional concentration of inspired oxygen should be verified with an oxygen monitor. Administration of excessive oxygen to a patient may be harmful. It is imperative that the prescribed gas mixture is delivered by the blending system.

The Water Trap must be drained at intervals as described in Chapter 7, Maintenance and Troubleshooting. If the ventilator is operating, leave a small amount of water at the bottom of the Water Trap container to act as a flow and pressure seal between the ventilator and the output of the drain.

F. Explanation of Symbols

To help prevent patient injury due to humidifier malfunction, the use of a humidifier with the following characteristics is strongly recommended:

- Thermally protected heater.
- Alarms on over-filled water reservoir.
- Alarms on under-filled water reservoir.
- Alarms when electrically open or shorted temperature probe detected.
- Alarms at probe temperatures > 41°C.
- Alarms when dislodged temperature probe detected.

Do not place on the Control Package of the ventilator any fluid-containing accessories, accessories that weigh more than ten pounds, or accessories that extend more than six inches above the ventilator electronics package or beyond its sides. This could cause damage to the ventilator, or could cause the ventilator to tip over, resulting in patient or user injuries and/or damage to the equipment.





Do not overturn the Patient Circuit Calibration screw, as this may cause damage to the device. When it is nearing its adjustment limit, it will reach a mechanical stop.

Do not allow liquids to penetrate the air vents of the ventilator as this may result in machine failure or malfunction.

Do not use a liquid sterilization agent on the outside of the ventilator as this may cause damage.

F. Explanation of Symbols

The following symbols are used on this device:

-  Circuit Breaker On
-  Circuit Breaker Off
-  Attention, Consult Accompanying Documents
-  Alternating Current / Voltage

G. Exterior Labels

Equipment of Type B

Position Lock—clockwise rotation locks instrument top. Counter-clockwise rotation unlocks instrument top, allowing it to be swiveled for best view of front controls and displays.

G. Exterior Labels

This section identifies the labels attached to the exterior of the 3100B. All labels are shown at approximately their actual size. Your system may not have all of the labels listed.

Patient Circuit Calibration Procedure

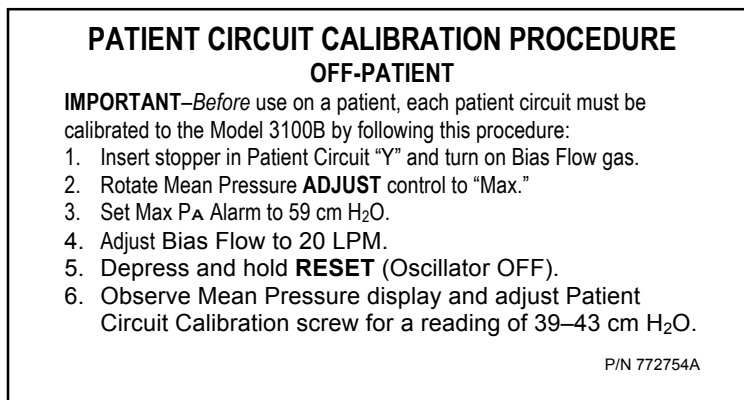
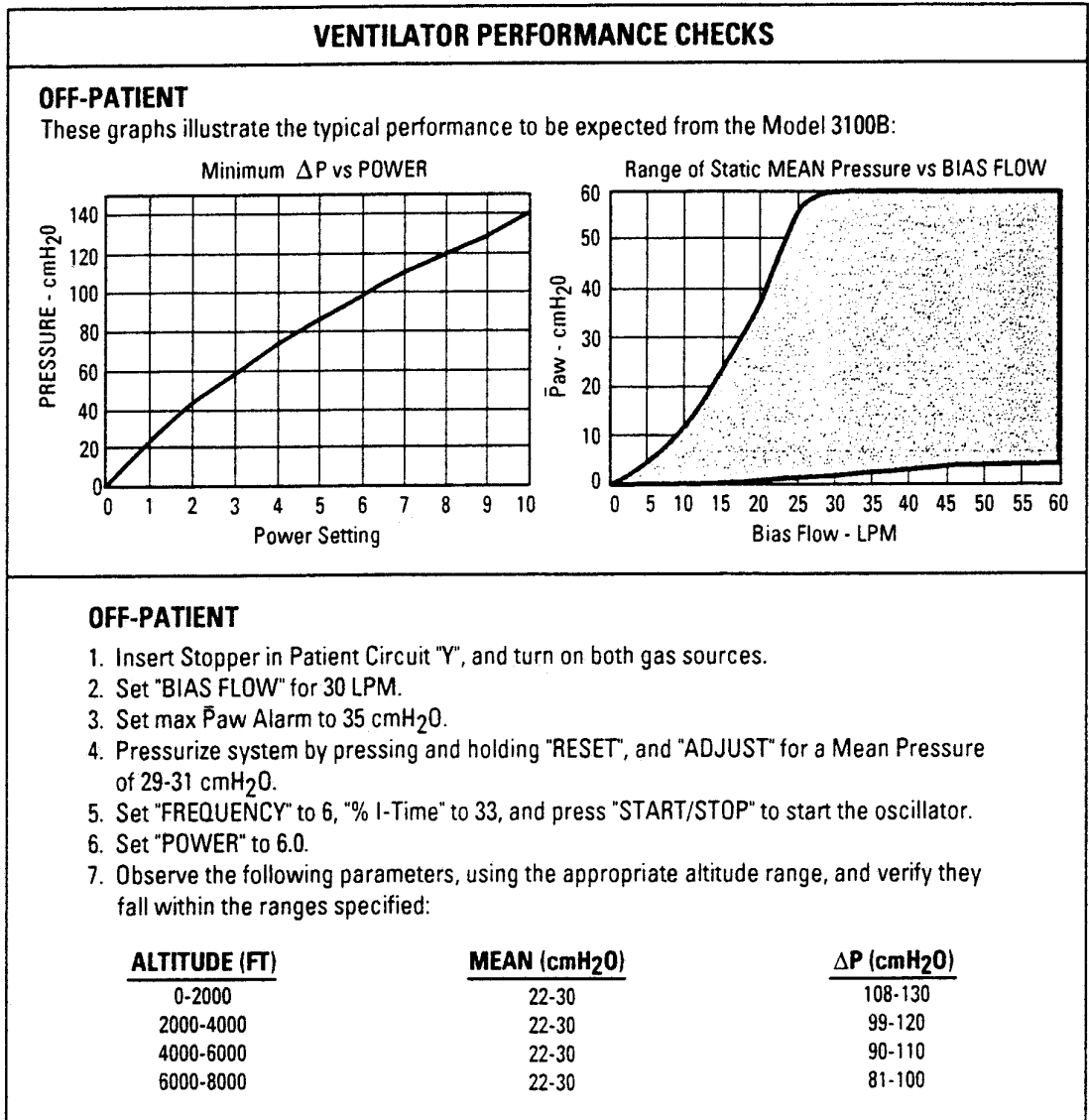

Figure 1.1. Patient Circuit Calibration Procedure Label.

The Patient Circuit Calibration Procedure Label describes the steps necessary to calibrate the patient circuit to the 3100B. This procedure is also explained in the Patient Circuit Calibration Section of Chapter 7, Maintenance and Troubleshooting.

Ventilator Performance Checks



767165-101F

Figure 1.2. Ventilator Performance Checks Label.

The Ventilator Performance Checks Label assists in setting Power, Mean Pressure Adjust, and Bias flow controls to achieve specific ranges of ΔP and P_A . These procedures are explained in the Performance Verification Section of Chapter 6, Operational Verification and Start-up Procedures.

G. Exterior Labels

Blender/Cooling Gas Filter Replacement Record

BLENDER COOLING GAS FILTER REPLACEMENT RECORD			
<i>Filters should be replaced every 500 hours of operation.</i>			
REPLACED	REPLACED	REPLACED	REPLACED
_____ Hrs	_____ Hrs	_____ Hrs	_____ Hrs
_____ Hrs	_____ Hrs	_____ Hrs	_____ Hrs
_____ Hrs	_____ Hrs	_____ Hrs	_____ Hrs
_____ Hrs	_____ Hrs	_____ Hrs	_____ Hrs
_____ Hrs	_____ Hrs	_____ Hrs	_____ Hrs
_____ Hrs	_____ Hrs	_____ Hrs	_____ Hrs
_____ Hrs	_____ Hrs	_____ Hrs	_____ Hrs
_____ Hrs	_____ Hrs	_____ Hrs	_____ Hrs
_____ Hrs	_____ Hrs	_____ Hrs	_____ Hrs
_____ Hrs	_____ Hrs	_____ Hrs	_____ Hrs
_____ Hrs	_____ Hrs	_____ Hrs	_____ Hrs

P/N 767159 A

Figure 1.3. Blender/Cooling Gas Filter Replacement Record Label.

The Blender/Cooling Gas Filter Replacement Record Label provides a place to document the 500 hour gas filter changes. For more information, see the Operator Maintenance Procedures Section of Chapter 7, Maintenance and Troubleshooting.

Driver Replacement Record

Driver Replacement Record			
Drivers should be replaced every 2000 hours of operation.			
Replaced	Driver S/N	Replaced By	Date
Hrs	_____	_____	_____
Hrs	_____	_____	_____
Hrs	_____	_____	_____
Hrs	_____	_____	_____
Hrs	_____	_____	_____
Hrs	_____	_____	_____
Hrs	_____	_____	_____
Hrs	_____	_____	_____
Hrs	_____	_____	_____
Hrs	_____	_____	_____
Hrs	_____	_____	_____
Hrs	_____	_____	_____

P/N 773941A

Figure 1.4. Driver Replacement Record Label.

The Driver Replacement Record Label provides a place to document the 2000 hour replacement of the Oscillator Subassembly. For more information, see the Scheduled Periodic Maintenance Section of Chapter 7, Maintenance and Troubleshooting.

G. Exterior Labels

Radio Frequency Interference (RFI) Warning

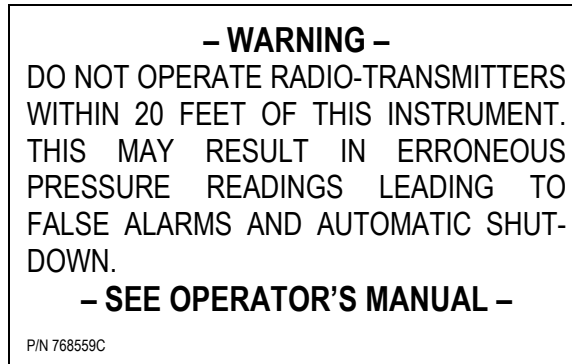

Figure 1.5. Radio Frequency Interference Warning Label.

The Radio Frequency Interference (RFI) Warning Label refers to the possible problems caused by interference from hand-held radio transmitters. The RFI warning is also discussed in the Troubleshooting Section of Chapter 7, Maintenance and Troubleshooting.

Name Rating Label

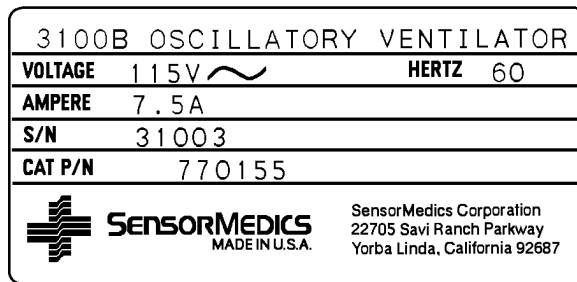

Figure 1.6. Name Rating Label.

The Name Rating Label lists specific information on each individual instrument: the Model Name and Number, the Voltage and Current Rating, the Serial Number, and the instrument's Catalog Part Number. (The example shown is for the 115V, 7.5A, 60Hz model; your instrument may have a different rating.)

Battery Attachment

Figure 1.7. Battery Attachment Label.

The Battery Attachment Label indicates the correct position for the installed Power Failure Alarm Battery. For directions on changing the battery, see the Changing the Power Failure Alarm Battery Section of Chapter 7, Maintenance and Troubleshooting.

Battery Specification

Figure 1.8. Battery Specification Label.

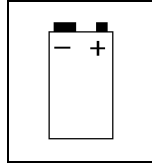
The Battery Specification Label indicates the type of Power Failure Alarm Battery (9V alkaline) that must be used. For directions on changing the battery, see the Changing the Power Failure Alarm Battery Section of Chapter 7, Maintenance and Troubleshooting.

A. Controls

A. Controls

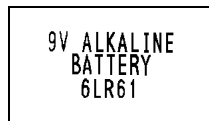
Bias Flow	0–60 liters per minute (LPM) Continuous, 15-turn control.
Resolution	2.5 LPM.
Accuracy	±10% of full scale at the following conditions: air or oxygen @ 70°F and 760 Torr.
Mean Pressure Adjust	Approximately 3–55 cmH ₂ O minimum range; Bias Flow dependent. (Refer to Ventilator Performance Checks in Chapter 6.)
Resolution	0.1 cmH ₂ O on airway pressure digital meter, 1-turn control.
Accuracy	Non-calibrated control knob.
Mean Pressure Limit	Automatic.
Power	At 100% power, $\Delta P > 90$ cmH ₂ O max amplitude of proximal airway pressure.
Resolution	Graduated 10-turn locking dial, not calibrated in % power.
Frequency - Hz	3–15 Hz oscillator frequency.
Resolution	0.1 Hz on digital meter, 10-turn control.
Accuracy	±5% of full scale.
% Inspiratory Time	30–50% of oscillatory cycle.
Resolution	±1% as read on digital meter.
Accuracy	±5% of full scale.
Start/Stop	Oscillator enable/disable.
Set Max P_A Alarm Thumbwheel	0–59 cmH ₂ O mean airway pressure.
Resolution	1 cmH ₂ O.
Accuracy	Within ±2 cmH ₂ O.

Set Min P_A Alarm Thumbwheel	0–59 cmH ₂ O mean airway pressure.
Resolution	1 cmH ₂ O.
Accuracy	Within ± 2 cmH ₂ O.
45-Sec Silence	Inhibits audible alarm function for 45 seconds (± 5 seconds).
Reset	Resets P _A >60 cmH ₂ O and <5 cmH ₂ O alarms if condition has been corrected; always resets power failure alarm. Resets Max P _A visual alarm.
Patient Circuit Calibration	Adjusts maximum mean pressure that can be obtained with a specific Patient Circuit (refer to Chapter 7 for setup procedure).
AC Power	On/off.

B. Indicators

Oscillator Enabled	Green LED (Light Emitting Diode) on Start/Stop pushbutton.
Oscillator Stopped	Red LED.
45-SEC Silence	Yellow LED on pushbutton.
P_A >60 cmH₂O	Red LED.
P_A <5 cmH₂O	Red LED.
Set Max P_A Exceeded	Red LED.
Set Min P_A Exceeded	Red LED.
Power Failure	Red LED (Power Failure / Reset Pushbutton).
Oscillator Overheated	Yellow LED.
Battery Low	Yellow LED.
Source Gas Low	Yellow LED.

C. Pressure Measurement

ΔP	Digital meter readout of ΔP to the nearest cmH ₂ O.
% Inspiratory Time	Digital meter readout of set % inspiratory time.
Frequency - Hz	Digital meter readout of set oscillator frequency in Hertz.
Mean Pressure Monitor	Digital meter readout of mean airway pressure measurement to the nearest tenth of a cmH ₂ O.
Elapsed Time	Digital readout of hours of power applied to the Model 3100B HFOV to nearest tenth of an hour.
Set Max P_A	Thumbwheel switch marked in cmH ₂ O.
Set Min P_A	Thumbwheel switch marked in cmH ₂ O.
Alarm (audible)	3K-Hertz modulated tone.
AC Power	Visual indication of AC power applied (I/O).

C. Pressure Measurement

Range	-130 to +130 cmH ₂ O airway pressure.
Resolution	0.1 cmH ₂ O.
Accuracy	Within $\pm 2\%$ of reading or ± 2 cmH ₂ O, whichever is greater, assuming periodic calibration as described in Chapter 7.
Transducer Pressure Limit	20 psig.

Warning

Failure to comply with the recommended maintenance procedures for the Airway Pressure Monitor as described in Chapter 7 could result in injury to the patient or operator or could result in damage to the equipment.

D. Alarms

Safety	Audible and visual indicators, machine intervention.
$P_A > 60 \text{ cmH}_2\text{O}$	Indicators activated, oscillator stopped, and dump valve opened when limit exceeded.
Resolution	Preset.
Accuracy	$\pm 2\%$ of pressure monitor reading or $\pm 2 \text{ cmH}_2\text{O}$, whichever is greater.
$P_A < 5 \text{ cmH}_2\text{O}$	Indicators activated, oscillator stopped, and dump valve opened when limit exceeded.
Resolution	Preset to $5 \text{ cmH}_2\text{O}$.
Accuracy	$\pm 2\%$ of pressure monitor reading or $\pm 2 \text{ cmH}_2\text{O}$, whichever is greater.
Warning	Audible and visual indicators, operator intervention.
Set Max P_A exceeded	Indicators activated when set limit exceeded.
Range	$0\text{--}59 \text{ cmH}_2\text{O}$.
Resolution	$1 \text{ cmH}_2\text{O}$.
Accuracy	$\pm 2\%$ of pressure monitor reading or $\pm 2 \text{ cmH}_2\text{O}$, whichever is greater.
Set Min P_A exceeded	Indicators activated when set limit exceeded.
Range	$0\text{--}59 \text{ cmH}_2\text{O}$.
Resolution	$1 \text{ cmH}_2\text{O}$.
Accuracy	$\pm 2\%$ of pressure monitor reading or $\pm 2 \text{ cmH}_2\text{O}$, whichever is greater.
Caution	Visual alarm, operator intervention.
Oscillator Overheated	Indicator activated when oscillator coil reaches a temperature of 150°C .
Accuracy	$\pm 5\%$.

E. Electrical

Battery Low	Indicator activated when battery which operates power failure alarm is low and must be replaced.
Source Gas Low	Indicator activated when blended gas or oscillator air cooling source pressure drops below 30 psig limit.
Accuracy	±5% in source gas mode.
45-second Silence	Indicator Activated for 45 seconds when pushbutton pushed.
Accuracy	±5 seconds.
Power Failure	Audible and visual indicators activated when power switch turned off, power plug unplugged, or insufficient supply voltage within the electronics package.
Oscillator Stopped	Audible and visual indicators activated when patient's airway ΔP falls below 5 to 7 cmH ₂ O.

Warning

An audible alarm indicates the existence of a condition potentially harmful to the patient and should not go unattended. Failure to respond to alarms could result in injury (including death) to the patient and/or damage to the ventilator.

E. Electrical

Power Requirements	115 VAC, 7.5A, 60 Hz 100 VAC, 7.5A, 50 Hz 220 VAC, 4.0A, 50 Hz 240 VAC, 4.0A, 50 Hz.
Leakage Current	<100 Microamperes.
Overload Protection	Dual electromagnetic circuit breaker.
Power Line Connection	3-wire grounded hospital-grade plug.
Safety Standards	Designed to CSA C22.2 No.125 and UL-544. Designed to IEC 601-1.

F. Pneumatic Connections

European Regulatory Approvals

The 3100B Oscillatory Ventilator complies with the Medical Device Directive, MDD 93/42/EEC, and is labeled with the CE Mark as shown below.



Warning

Do not attempt to defeat the proper connection of the ground wire. Improper grounding may cause damage to the device or interconnected equipment and could be injurious to patient or to those associated with the device use. This device is factory equipped with a hospital-grade AC power plug. Grounding reliability can only be assured when connected to a tested receptacle labeled "Hospital Grade."

F. Pneumatic Connections

Inlet From Blender (Air/O₂)	DISS oxygen fitting.
Pressure Range	40–60 psig.
Maximum Flow	60 LPM ±10%.
Overpressure Protection	75 psig ±15% relief valve.
Air Cooling Inlet	DISS air fitting.
Pressure Range	40–60 psig.
Flow	25 LPM±10%
Overpressure Protection	75 psig ±15% relief valve.
Outlet to Humidifier	3/8" barbed fitting.
Overpressure Protection	5 psig ±15% relief valve.
P_A Control Valve	Coded green, Luer bulkhead.

G. Physical

P_A Limit Valve	Coded blue, Luer bulkhead.
Dump Valve	Coded red, Luer bulkhead.
P_A Sensing	Coded white, Luer bulkhead.

G. Physical

Materials	All materials used in the construction of the 3100B instrument and its breathing circuit are non-toxic and pose no safety risk to the patient or operator.
Dimensions of Column and Control Package	Height: 53.8" Width: 18.6" Depth: 11.4" Weight: 143 lbs.
Pedestal	5 legs each with 4" diameter locking wheels, 28" width across bottom of pedestal.

Precaution

Do not place on the control package of the ventilator any fluid-containing accessories, accessories that weigh more than 10 pounds, or accessories that extend more than six inches above the ventilator electronics package or beyond its sides. This could cause damage to the ventilator, or could cause the ventilator to tip over, resulting in patient or user injuries and/or damage to the equipment.

Required Environmental and Operational Conditions	<ol style="list-style-type: none">1. Temperature: 5–28°C2. Humidity: 15%–95% (non-condensing)3. Certain specific environmental factors such as Electrostatic Discharge (ESD) and Electromagnetic Interference (EMI) require special consideration by the operator. For an in-depth discussion of these factors, see the Troubleshooting section of Chapter 7, Maintenance and Troubleshooting.
--	--

H. 3100B Performance Graphs

3-Ohm Driver
Distal Tidal Volume vs.
Frequency at Maximum Power

- Two % I-Time Settings
- Single ET Tube Size (7mm)
- Single Compliance (19ml/cmH₂O)

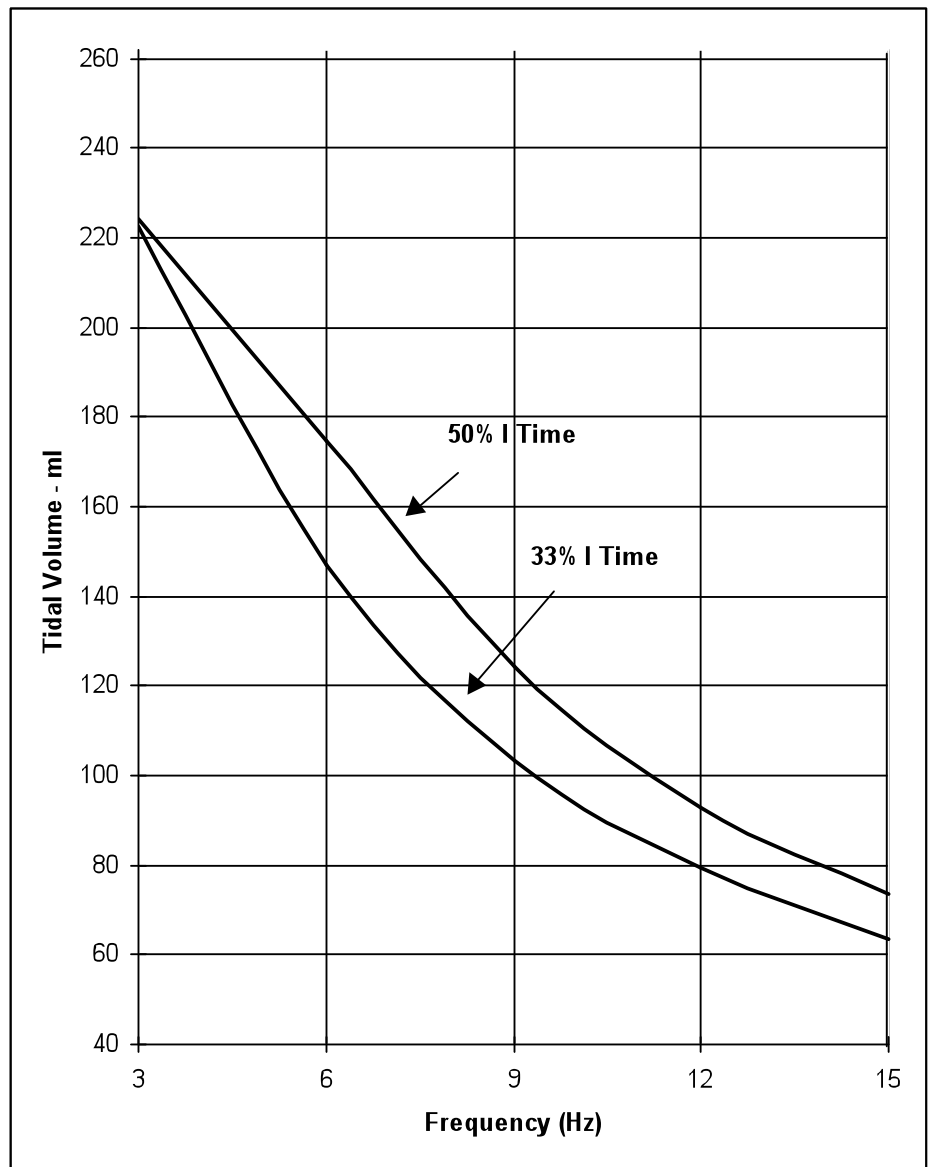

Figure 2.1

H. 3100B Performance Graphs

3-Ohm Driver
Distal Tidal Volume vs. Power
Setting at 33% I-Time

- Three ET Tube Sizes
- Single Compliance (19ml/cm H₂O)

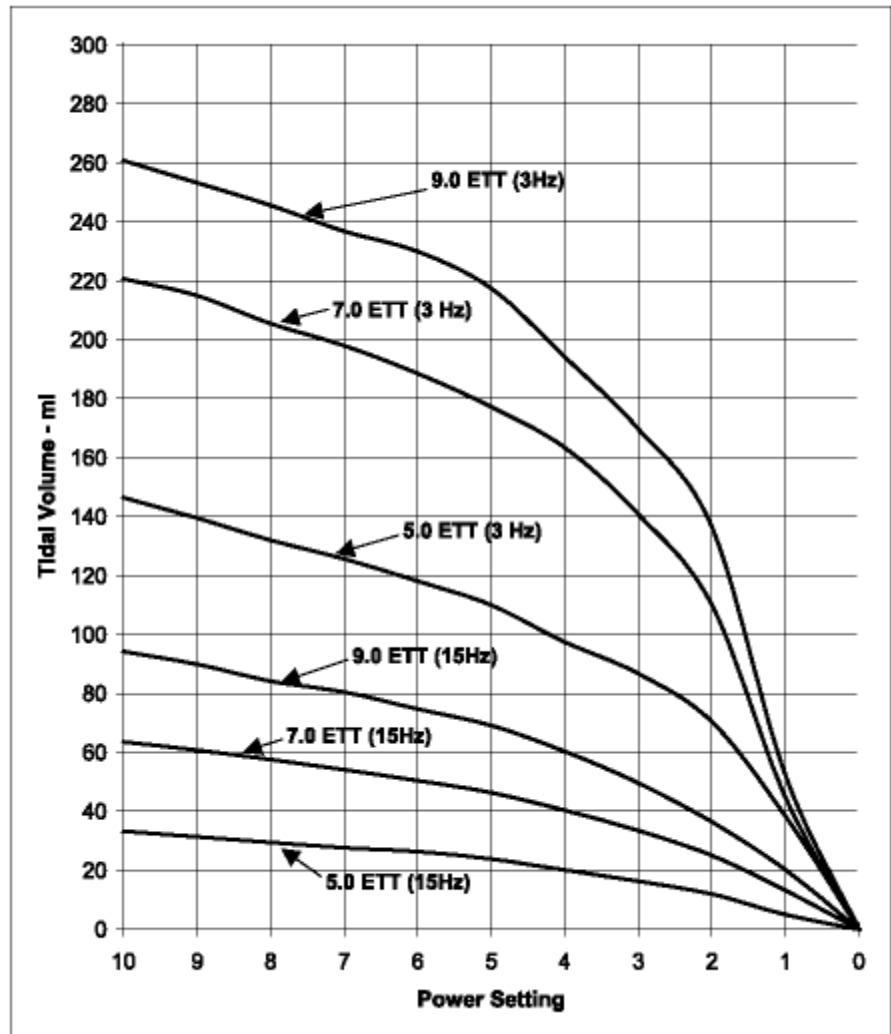

Figure 2.2

H. 3100B Performance Graphs

**3-Ohm Driver
Distal Tidal Volume vs.
Frequency at Maximum Power
and 33% I-Time**

- Three ET Tube Sizes
- Single Compliance (19ml/cm H₂O)

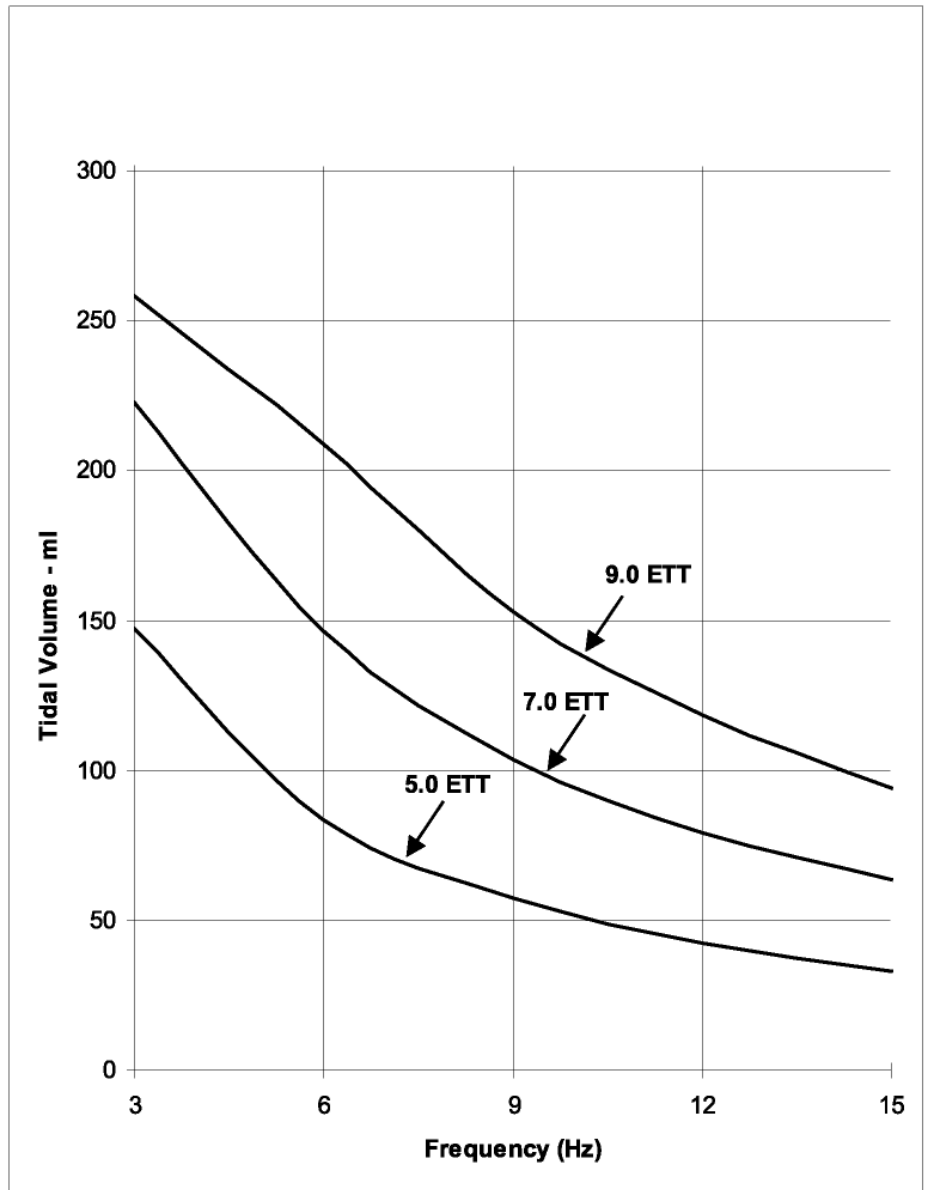

Figure 2.3

H. 3100B Performance Graphs

3-Ohm Driver
Distal Tidal Volume vs.
Frequency at Maximum Power
and 50% I-Time

- Three ET Tube Sizes
- Single Compliance (19ml/cm H₂O)

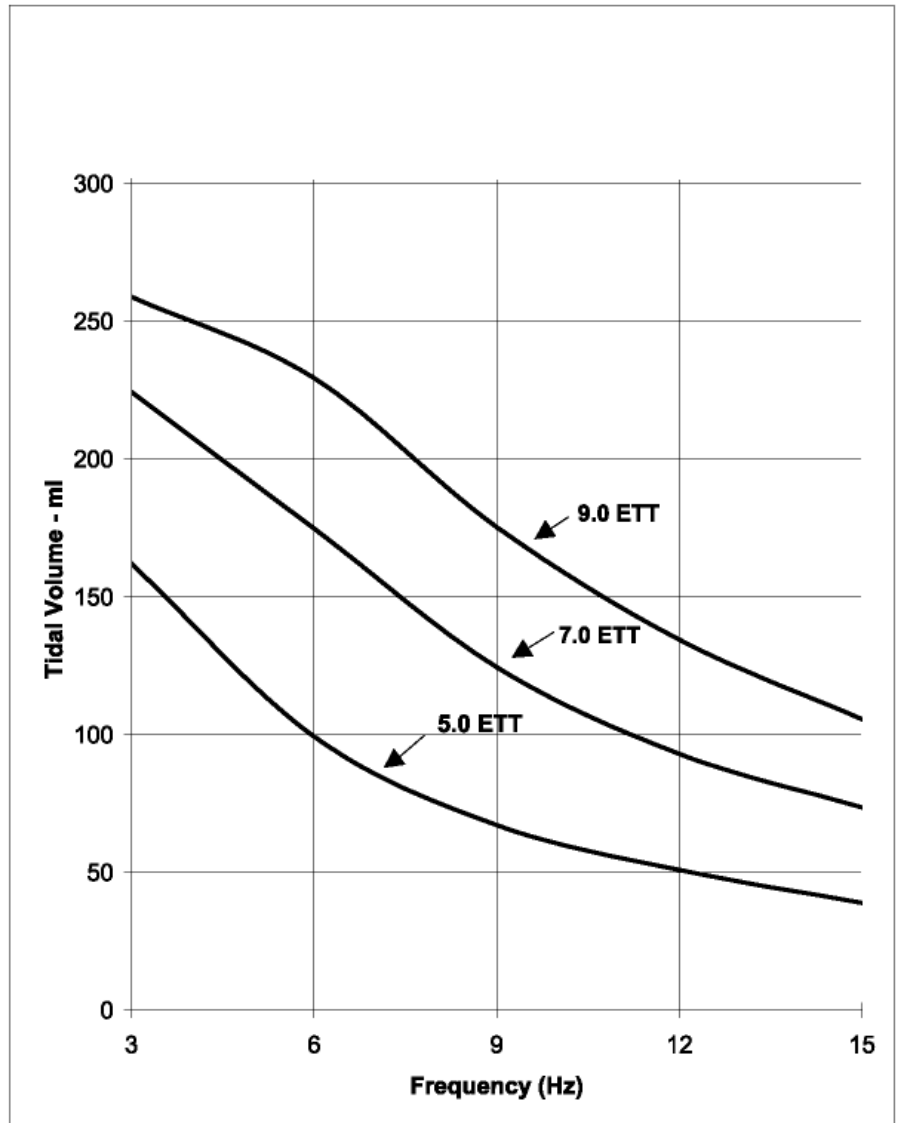

Figure 2.4

H. 3100B Performance Graphs

**3-Ohm Driver
Distal Tidal Volume vs. Power
Setting at 50% I-Time**

- Three ET Tube Sizes
- Single Compliance (19ml / cm H₂O)

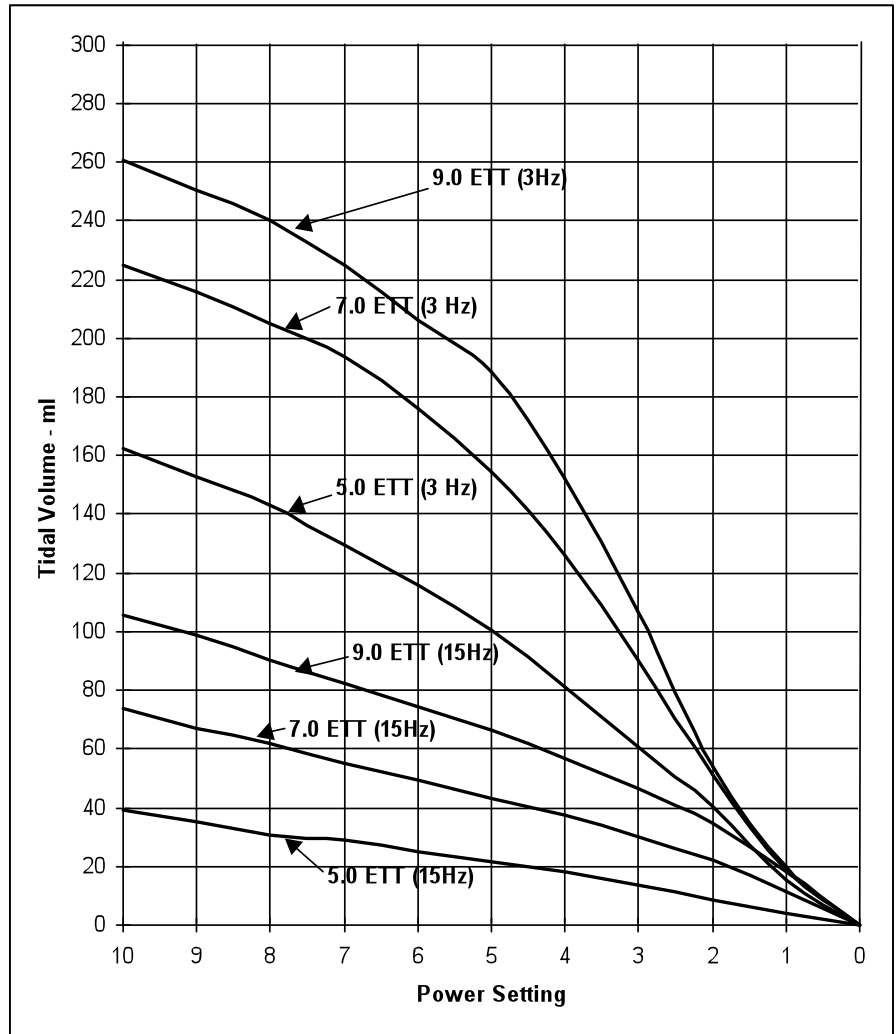

Figure 2.5

A. Introduction

A. Introduction

The system consists of eight subsystems, six included as part of the Model 3100B and two provided by the user:

Subsystems Provided by the User

1. External Air/O₂ Blender and Oxygen Monitor
2. External Humidifier

Subsystems Included with Ventilator

3. Pneumatic Logic and Control.
4. Patient Circuit.
5. Oscillator Subsystem.
6. Airway Pressure Monitor.
7. Electronic Control and Alarm Subsystem.
8. Electrical Power Supply.

B. External Air/O₂ Blender

Both oxygen and air pressure sources are required as specified in Chapter 2. These sources feed a user-provided Air/Oxygen Blender. The air source also provides cooling to the Oscillator Subsystem by means of a special pneumatic control system. The flow requirements for both the blender and for the air cooling of the Oscillator Subsystem are described in Chapter 2.

Precaution

Fractional concentration of inspired oxygen should be verified with an oxygen monitor. Administration of excessive oxygen to a patient may be harmful. It is imperative that the prescribed gas mixture is delivered by the blending system.

It is the responsibility of the user to provide an Oxygen/Air Blender and Oxygen Concentration Monitor. The blender shall be capable of 60 L/min flow. When used in conjunction, the accuracy shall be $\pm 3\%$. Monitoring should be accomplished at an outlet of the blender in an unpressurized state.

C. External Humidifier

Although functioning in harmony with the Patient Circuit Subsystem, the External Humidifier is treated as a separate subsystem because it is provided by the user. The humidifier that is used must be a heated humidifier specifically manufactured for pediatric/adult use. It must be capable of covering a flow range up to 60 LPM. The temperature control can be either closed or open loop; however, proximal airway gas temperature must be monitored. Two ports for the temperature probe are provided on the Patient Circuit. These will be discussed in the next section.

D. Pneumatic Logic and Control

Warning

Under no circumstances should a proximal airway gas temperature of 41°C be exceeded. This could result in injury to the patient's airway membranes.

Warning

Do Not use the 3100B ventilator in environments where the ambient temperature is at or above 84°F (28°C). Use of the ventilator in these environments will result in extreme reduction in relative humidity in the patient's airway and possible desiccation of the patient airways.

Precaution

To help prevent patient injury due to humidifier malfunction, the use of a humidifier with the following characteristics is strongly recommended:

- a. Thermally protected heater.
- b. Alarms on overfilled water reservoir.
- c. Alarms on under filled water reservoir.
- d. Alarms when open or shorted temperature probe is detected.
- e. Alarms at probe temperatures > 41°C.
- f. Alarms when dislodged temperature probe is detected.

The connection of the humidifier into the Model 3100B HFOV System will be further described in Chapter 5, Assembly and Installation. Standard humidifier adapters are required, and two are provided for connecting the 3/8" I.D. tubing to and from the humidifier.

D. Pneumatic Logic and Control

The Blender feeds pressurized blended gas to the Model 3100B Pneumatic Logic and Control Subsystem through an oxygen DISS fitting. Four pneumatic controls are part of this subsystem:

E. Patient Circuit

Bias Flow

This control sets the flow of the blended gas that continuously moves past the patient airway.

Mean Pressure Adjust

This control adjusts the Mean pressure level on which the oscillatory waveform is superimposed. This Mean pressure along with the oscillatory waveform characteristics determines the resultant P_A . This control determines the level of Patient Circuit expiratory limb Control Valve restriction in the manner described in the Patient Circuit section below.

Patient Circuit Calibration

This control is a screwdriver adjustment used to set the maximum mean pressure that can be attained with a particular Patient Circuit under specified conditions (see Chapter 7, Maintenance and Troubleshooting.) This control is used only when the Patient Circuit is replaced or the P_A control valve diaphragm of the existing Patient Circuit is changed. The control is necessary because the individual elastic and dimensional characteristics of the P_A control valve diaphragm interact with the valve control line pressure to determine the control dial maximum setting.

Precaution

Do not overturn the Patient Circuit Calibration as this may cause damage to the device. When it is nearing its adjustment limit, it will reach a mechanical stop.

The range, resolution, and accuracy of the pneumatic controls—and the characteristics of the various pneumatic connections are described in Chapter 2. Chapter 4 provides a detailed description of the functions and use of each control.

E. Patient Circuit**Warning**

Do not attempt to substitute another circuit configuration as this could result in injury to the patient and/or the operator, or cause equipment malfunction. The Patient Circuit described in this manual is specifically designed for patient use with the Model 3100B HFOV.

E. Patient Circuit

The Patient Circuit combines the three elements necessary for ventilation of the patient using HFOV techniques: bias flow/ Mean pressure, pressure oscillations, and pressure limiting. The Patient Circuit is illustrated in Figure 3.1.

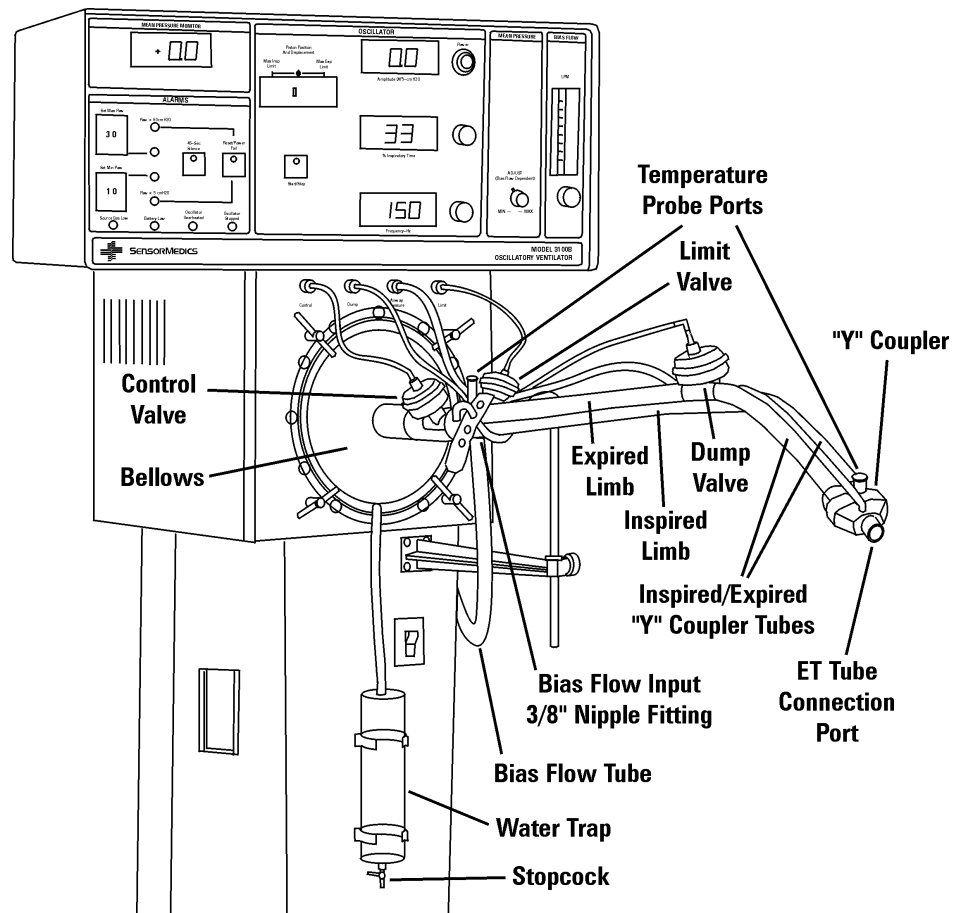

Figure 3.1. Details of Patient Circuit.

During normal operation, humidified, blended bias gas flows into the continuous flow line from the External Humidifier. This gas flows into and through the inspiratory limb of the Patient Circuit, through the "Y" coupler and then into the expiratory limb of the Patient Circuit. While passing through the "Y" coupler, the fresh gas exchanges oxygen and carbon dioxide at the ET tube/patient connection.

E. Patient Circuit

A proximal airway pressure sensing line made of 1/8" Tygon tubing runs from the "Y" coupler to the Airway Pressure Monitor via a white Luer bulkhead fitting near the Patient Circuit connection. The pressure signal is processed to determine various pressure measurements and alarm conditions. The Airway Pressure Monitor and tubing are discussed in a following section.

The expiratory limb carries the exchanged gas to the P_A Control Valve. This valve allows two expiratory flow paths. One path is a variable restriction controlled by the P_A Control Valve control line extending from the Pneumatic Logic and Control Subsystem via a green Luer bulkhead fitting near the Patient Circuit connection. The other flow path is a fixed orifice that requires a minimum bias flow be maintained through the Patient Circuit to ensure a flow of fresh Bias Gas regardless of the setting of the P_A Control Valve.

When the P_A Control Valve is changed, it adjusts the mean airway pressure at the ET tube/patient connection after about five system time constants have elapsed, but only if the set bias flow and oscillator characteristics remain unchanged for the same time period. Five time constants will vary from about one second to as long as 30 seconds. This time constant varies directly with P_A and inversely with bias flow.

The individual elastic and dimensional characteristics of the P_A Control Valve diaphragm interact with the valve control line pressure to determine the control dial maximum setting. The Patient Circuit Calibration control provides a screwdriver adjustment to set the maximum mean pressure that can be attained with a particular Patient Circuit under specified conditions. This control is used only when the Patient Circuit is replaced or the P_A control valve diaphragm of the existing Patient Circuit is changed. Refer to Chapter 7, Maintenance and Troubleshooting, for the complete setup procedure.

The Pressure Limit Valve limits the P_A. When an abnormal condition exists or when the system mean pressure increases due to an inadvertent or deliberate control setting change, this valve acts to limit the mean proximal airway pressure.

Both the P_A Control Valve and the Pressure Limit Valve are mushroom valves that must be replaced periodically according to the procedures in Chapter 7, Maintenance and Troubleshooting.

The Dump Valve is activated by the Electronic and Pneumatic Control Subsystems only when the safety alarms are activated. The safety alarms are the following:

1. $P_A > 60 \text{ cmH}_2\text{O}$
2. $P_A < 5 \text{ cmH}_2\text{O}$

The Dump Valve, when activated, will open the entire Patient Circuit to ambient air. It allows the patient the opportunity to breathe spontaneously at normal atmospheric pressure when the safety alarms have been activated. In an emergency situation, the Dump Valve helps to prevent a decrease in cardiac output due to sustained elevated Patient Circuit pressure or atelectasis due to a negative Patient Circuit pressure.

The Dump Valve is a mushroom valve that must be replaced at intervals as described in Chapter 7.

Two ports are provided for inserting the temperature probe of the External Humidifier. One is near the patient "Y"; the other is near the Pressure Limit Valve.

The inspiratory limb acts as the propagation means for the pressure oscillations generated by the Oscillator Subsystem. A typical airway pressure oscillatory waveform is illustrated in Figure 3.2.

E. Patient Circuit

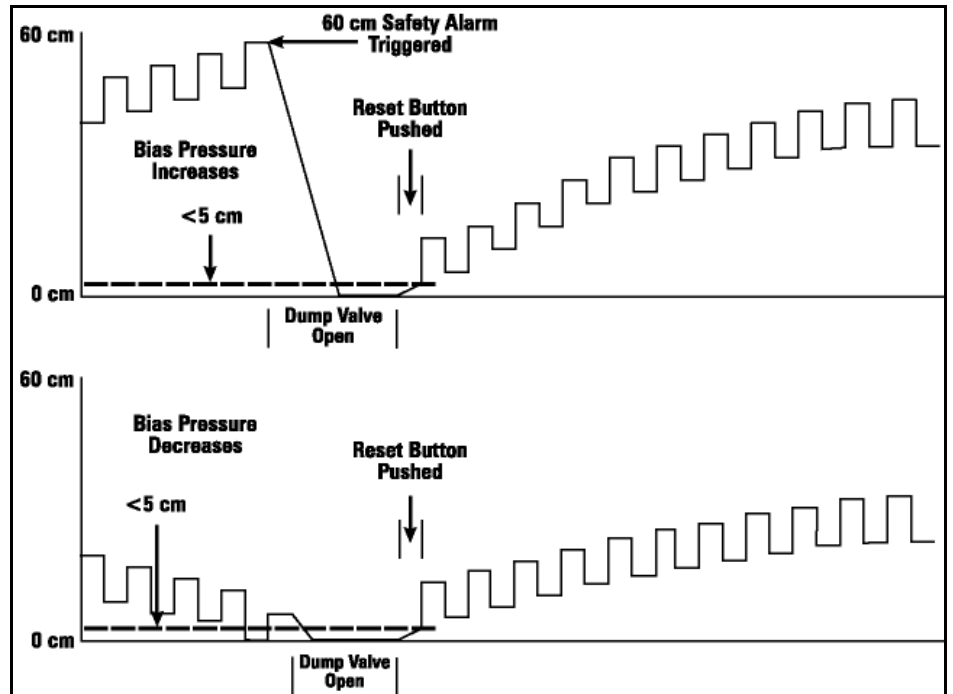

Figure 3.2. Typical Oscillatory Proximal Airway Pressure Waveforms With Dump Valve Activation.

This figure also illustrates the activation of the dump valve due to the P_A being less than the $<5 \text{ cmH}_2\text{O}$ limit or greater than the $60 \text{ cmH}_2\text{O}$ limit.

To prevent accumulation of water from condensate within the Patient Circuit and Oscillator Subsystems, a Water Trap drains them through the Oscillator Compartment. Consult Chapter 7, Maintenance and Troubleshooting, for details on use of Water Trap.

Precaution

The Water Trap must be drained at intervals as described in Chapter 7, Maintenance and Troubleshooting.

The function of the controls discussed in the paragraphs above as well as the function of the safety alarms are discussed further in Chapter 4, Location and Function of Controls, Indicators, and Connections. The assembly of the Patient

F. Oscillator Subsystem

Circuit onto its mounting arm and its connection to the rest of the HFOV system is discussed in Chapter 5, Assembly and Installation.

F. Oscillator Subsystem

The components of the Oscillator Subsystem are illustrated in Figure 3.3. The design incorporates an electronic control circuit (square-wave driver) which drives a linear motor which in turn drives a piston assembly. It is very similar to a permanent magnet speaker.

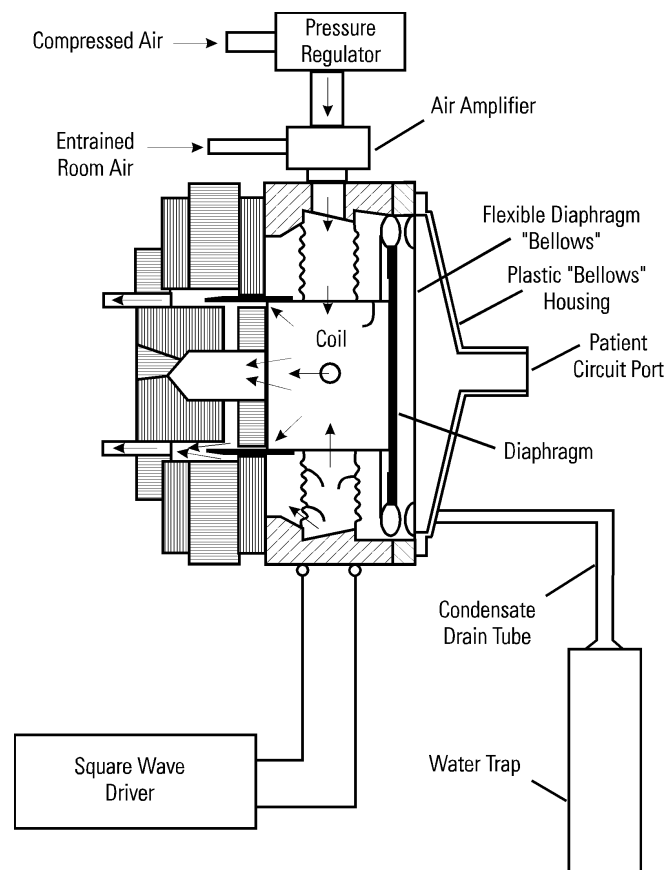

Figure 3.3. Details of Oscillator Subsystems.

One of the major features of the design is that there is no physical contact between the permanent magnet and the electrical coil which is suspended by “spiders” within the permanent magnet. This results in a very efficient frictionless oscillator system with an operational life of more than 2,000 hours.

F. Oscillator Subsystem

When the square-wave driver is of positive polarity, it drives the electrical coil and the attached piston forward in the direction of the patient (inspiration). When the polarity is negative, it drives the electrical coil and the attached piston in the opposite direction (expiration).

The distance the piston is driven in each direction is determined by the magnitude of the alternating polarity voltage applied to the electrical coil, the Patient Circuit pressure encountered by the piston plate, the piston coil counter-force current, and the frequency of the square wave. The voltage of the square-wave driver output is controlled by the Power Control of the Electronic Control and Alarm Subsystem.

There are two mechanical stops which determine the maximum piston displacement in the full inspiration and full expiration directions. The maximum stroke of the piston defined by these stops is approximately 365 milliliters.

The % inspiratory time is determined by another control on the Electronic Control and Alarms Subsystem. This control sets the relative duration of the successive positive and negative polarity voltages from the square-wave driver, which is driving the electrical coil and piston. This control also establishes the counter-force current to overcome the tendency of the mean airway pressure to displace the piston off center.

As mentioned previously, the displacement of the electrical coil and piston is determined by the magnitude of the voltage applied to the electrical coil. The total transit time required for this displacement is only a matter of milliseconds. Therefore, at the lower oscillation frequencies, the piston will remain stationary at its full-travel position for the majority of that particular respiration phase (inspiratory or expiratory).

As the oscillation frequency increases, the transit time of the electrical coil and piston to its set full displacement will become a larger percentage of the total respiratory phase duration. Although exactly determined by conditions within the Patient Circuit, as frequency is increased the electrical coil and piston are unable to complete full displacement before the square-wave driver switches polarity requiring the travel direction to reverse. Thus, the displacement amplitude of the oscillator piston will decrease as the oscillation frequency is increased.

Refer to Chapter 2, Specifications, for details on the range, resolution, and accuracy of the various control functions affecting the Oscillator Subsystem.

G. Airway Pressure Monitor

Refer to Chapter 4, Location and Function of Controls, Indicators, and Connections, for a full description of the use of these controls.

Because the major portion of the Oscillator Subsystem is a linear motor, some type of cooling mechanism must be provided for the electrical coil. The cooling source used in the Model 3100B is air flow obtained from a standard 50 psig gas wall outlet. A regulator within the Oscillator Subsystem meters the airflow to a Venturi-type air cooler at 25 LPM, which then entrains room air at approximately 75 LPM, thus providing 100 LPM of cooling air around the electrical coil.

A thermal cutout circuit has been incorporated into the oscillator to shut it down in case of overheating caused by a cooling system failure. Such a failure, if allowed to occur without oscillator shutdown, could result in the destruction of the oscillator coil's support spiders. The thermal cutout system utilizes a thermistor on the oscillator coil form to detect temperature rise. Thermal shutdown will occur if coil temperature exceeds 175°C.

Prior to an oscillator thermal shutdown, the operator is given an indication that the coil is overheating. A yellow caution LED on the front panel of the Control Package lights when the coil temperature reaches approximately 150°C.

G. Airway Pressure Monitor

The Airway Pressure Monitor is a very key subsystem within the Model 3100B HFOV system. The majority of the safety and warning alarms rely upon the mean airway pressure determinations of the Airway Pressure Monitor.

The Airway Pressure Monitor senses the pressure within the Patient Circuit through 1/8" tubing running from the "Y" coupler of the Patient Circuit to the airway pressure monitor transducer. A 500 ml/min trickle flow of dry gas from the blender flows constantly from the 3100B to the patient "Y" to keep water vapor from even partially obstructing this pressure sensing pathway.

Warning

Failure to comply with the recommended maintenance procedures for the Airway Pressure Monitor as described in Chapter 7 could result in injury to the patient or operator or could result in damage to the equipment.

The Airway Pressure Monitor processes the instantaneous airway pressure measurements of its pressure transducer to derive the following:

1. Mean airway pressure (P_A)

H. Electronic Control and Alarm Subsystem

2. Oscillatory peak minus oscillatory trough pressure (ΔP)

Mean Airway Pressure is essentially an arithmetic mean of the airway pressure measurement. It is obtained by filtering the instantaneous pressure signal with a DC to 0.5 Hz. low pass filter.

The ΔP reading is obtained by subtracting the oscillatory trough pressure from the peak pressure.

A detailed list of specifications for the Airway Pressure Monitor is contained in Chapter 2. A detailed description of the use of its control and display is contained in Chapter 4.

H. Electronic Control and Alarm Subsystem

This subsystem contains the Oscillator Subsystem Controls and the alarm functions. It consists of various electronic circuits and logic elements. It integrates information received from the Airway Pressure Monitor to react in a fashion safest for the patient. It utilizes this information to orchestrate the activity of the Oscillator Subsystem and the Pneumatic Logic and Control Subsystem.

The following are the Oscillator Subsystem controls which form a part of the Electronic Control and Alarm Subsystem:

1. Power
2. % Inspiratory Time
3. Frequency-Hz
4. Start/Stop

The operation and use of these controls is described in detail in Chapter 4.

The subsystem also contains the following indicators for reporting on the Oscillator Subsystem status:

1. Start/Stop LED
2. ΔP digital meter
3. % Inspiratory Time digital meter

I. Electrical Power Supply

4. Frequency digital meter

The coordination of these indicators with the Oscillator Subsystem controls is described in detail in Chapter 4.

The following alarm controls and indicators are part of this section:

1. Max P_A exceeded thumb wheel and LED
2. Min P_A exceeded thumb wheel and LED
3. $P_A > 60$ cmH₂O LED
4. $P_A < 5$ cmH₂O
5. 45-Sec Silence pushbutton and LED
6. Reset pushbutton
7. Battery Low LED
8. Source Gas Low LED
9. Oscillator Overheated LED
10. Oscillator Stopped LED
11. Power Failure LED

The range, resolution, and accuracy of these alarm functions are described in Chapter 2. A detailed description of the use of these alarms, controls, and indicators follows in Chapter 4.

The function of the alarms is influenced by inputs from the Airway Pressure Monitor, Oscillator Subsystem, and Pneumatic Logic and Control Subsystem.

I. Electrical Power Supply

The Electrical Power Supply converts the AC line voltage to the DC voltages required to power the Electronic Control and Alarms Subsystem, the Airway Pressure Monitor, and the Oscillator Subsystem.

Detailed specifications are listed in Chapter 2. Maintenance procedures are covered in Chapter 7.

J. Safety Features

The Model 3100B HFOV system has been designed with numerous safety features both to help avoid patient injury and to protect the equipment from damage. These safety features are incorporated into the design of the various subsystems:

1. Warning Alarms
2. Safety Alarms

J. Safety Features

3. Power Failure Alarm
4. Oscillator Stopped Alarm
5. Caution Alarms
6. Oscillator thermal cutout
7. Water trapping for condensate
8. Pressure relief valves to protect the equipment from over-pressure damage
9. Oscillator startup logic to prevent application of excessively high or low oscillatory pressures to patient

The Warning Alarms consist of the Max and Min P_A Exceeded settings and indicators. In the event that the proximal pressure meets or exceeds the set Max P_A alarm setting, an audible and visual alarm will occur, and the ventilator will depressurize the Limit Valve seat pressure. Once the mean airway pressure falls to a level of 12 (± 3) cm H₂O below the Set Max P_A setting, the Limit Valve will re-pressurize to its normal operational state. Should the high mean airway condition persist, the alarm will repeat until the condition is resolved. Once corrected, the high P_A visual indicator will remain lit to notify the clinician that the alarm was violated. Depress the Reset / Power Failure button to reset the visual indicator. Should the proximal pressure meet or fall below the Min P_A setting an audible and visual alarm will occur which will automatically reset after correction of the alarm condition. No machine action is taken.

- + Operating the ventilator with low Bias Flow Rates (<15 lpm) and Low Mean Airway Pressures (<15 cmH₂O), with full power (Maximum Amplitude) may result in a low-pressure dump upon activation of the Max P_A Alarm.

The Safety Alarms consist of P_A > 60 cmH₂O and < 5 cmH₂O alarms. They are indicated in the same manner as the Warning Alarms described above. If either of these P_A alarms is activated, the oscillator is stopped (bias flow continues) and the Dump Valve opens the Patient Circuit to atmospheric pressure. Either of these alarms can be reset by pressing the Reset Button once the cause of the alarm condition has been corrected.

When the Power Failure Alarm is activated, no other machine actions are taken other than the energizing of a red LED and a 3K-Hertz modulated tone. The Power Failure Alarm is reset by pushing the Reset button whether or not the alarm condition (removal of or inadequate power supply to the Electronic Control and Alarms Subsystem) has been corrected. To restart the oscillator it will then

J. Safety Features

be necessary to press the Start/Stop Switch. It is normal for the Battery Low LED to light when the reset button is pressed.

The Caution Alarms activate a yellow LED only; no audible alarm occurs. The Caution Alarms are the following: Battery Low, Source Gas Low, Oscillator Overheated and 45-Sec Silence. The Battery Low or Source Gas Low and the Oscillator Overheated Caution Alarms are reset only by correction of the caution condition by the user. The 45-Sec Silence caution indicator will be illuminated for the duration of the 45-second alarm silence duration. During this 45-second period, the audible alarm will be silenced regardless of the alarm condition. All visual alarm indicators will operate normally.

The Oscillator Stopped Alarm will occur if ΔP is < 5 to 7 cmH₂O. A red LED and audible 3K-Hz. indication occurs. No action is taken by the machine and the alarm resets automatically upon correction of the alarm condition. Note that the oscillator may in fact be operating, but the resultant ΔP is below 5 to 7 cmH₂O. If the oscillator is disabled by pushing the Start/Stop button, the Oscillator Stopped alarm is disabled.

Warning

An audible alarm indicates the existence of a condition potentially harmful to the patient and should not go unattended. Failure to respond to alarms could result in injury (including death) to the patient and/or damage to the ventilator.

Precaution

When the ventilator is connected to a patient, it is imperative that someone be in attendance at all times in order to react to any alarms and to detect other indications of a problem.

A thermal cutout safety feature has been incorporated into the Oscillator Subsystem. This feature shuts down the oscillator if overheating occurs. If the oscillator were not shut down, such overheating could result in the destruction of the oscillator coil's support spiders. The thermal cutout system utilizes a thermistor on the oscillator coil form to detect temperature rise. Thermal shutdown will occur if coil temperature exceeds 175°C.

J. Safety Features

Prior to an oscillator thermal shutdown, the operator is given an indication that the coil is overheating. A yellow caution LED on the front panel of the Control Package lights when the coil temperature reaches approximately 150°C.

A Water Trap is incorporated into the Oscillator subsystem, as described in a previous section, to help eliminate condensate from the Patient Circuit. This is a safety feature not seen in many conventional ventilators with a similar water build-up potential. The Water Trap is easily emptied as described in Chapter 7, Maintenance and Troubleshooting.

Precaution

The Water Trap must be drained at intervals as described in Chapter 7, Maintenance and Troubleshooting. If the ventilator is operating, leave a small amount of water at the bottom of the Water Trap container to act as a flow and pressure seal between the ventilator and the output of the drain.

There are also mechanical pressure relief devices to protect the equipment from damage. A 75 psig mechanical relief valve protects the “Inlet from Blender” and the “Air Cooling Inlet” connections. The “Outlet to Humidifier” connection is protected by a 5 psig mechanical relief valve. These devices function whether the Model 3100B HFOV is electrically energized or not.

The oscillator will not start unless the controls are used in the proper sequence and/or set to the proper range. The startup procedure is described in Chapter 6, Operational Verification and Startup Procedures.

A. Introduction

A. Introduction

This chapter describes the location, function, and use of each control, indicator, and connection on the Model 3100B HFOV. They are illustrated with reference numbers on the illustrations contained within this chapter. Detailed specifications of the resolution and accuracy of controls and indicators are contained in Chapter 2. The theory of operation of the overall Model 3100B system and each of its subsystems is explained in Chapter 3, Description of System and Safety Features.

Precaution

Proper operation of the ventilator must be verified prior to each use. Refer to Chapter 6, Operational Verification and Startup Procedures. The alarm functions tested in this procedure verify the capability of the device to detect and indicate conditions which could have a harmful effect on the patient.

B. Front and Side Panel – Control Package

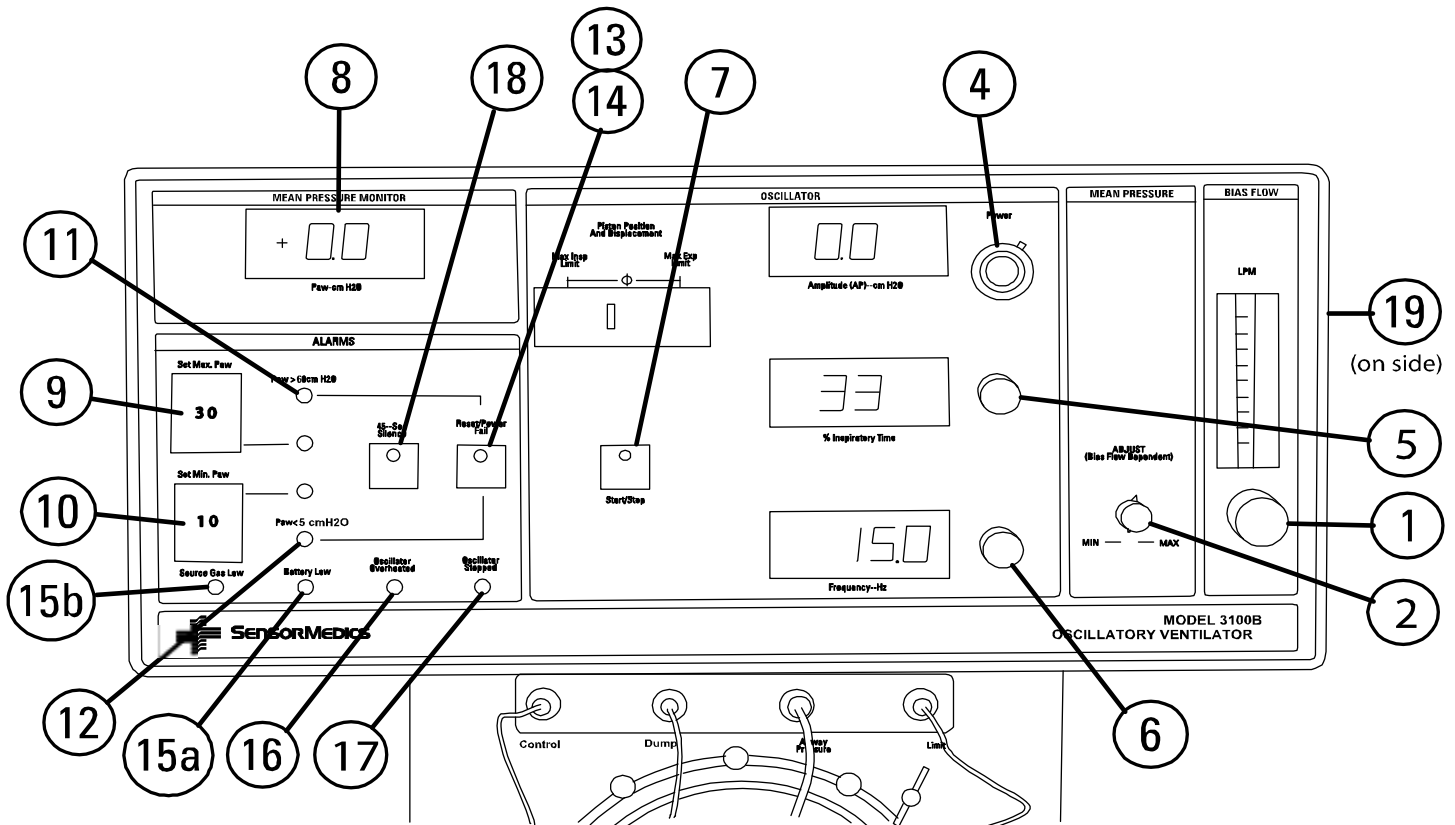

Figure 4.1. Front Panel Controls and Indicators.

The numbers shown on Figure 4.1 correspond to the numbers on the following descriptions.

1. Bias Flow

Controls and indicates the rate of continuous flow of humidified blended gas through the Patient Circuit. The control knob is a 15-turn pneumatic valve which increases flow as it is turned counterclockwise.

The rate of flow is indicated by a ball float within a rotameter glass tube graduated from 0 to 60 LPM in 5 LPM increments. The flow is read by aligning the center of the ball float with the rotameter scale mark corresponding to the

B. Front and Side Panel – Control Package

adjusted flow. The maximum achievable rate of flow is internally limited to 60 LPM.

2. Mean Pressure Adjust

Adjusts the mean airway pressure (P_A) by controlling the resistance of the P_A Control Valve. This control is a clockwise increasing 1-turn pneumatic valve.

The adjustment affected by this control is read on the Mean Pressure Monitor (8).

Since this control is not a closed-loop control, P_A will change if the bias flow setting is changed. Increasing the bias flow will increase the P_A . In addition, since the oscillatory pressure waveform introduced by the Oscillator Subsystem is nonsymmetrical, adjustment of the oscillator controls will also vary the P_A .

When adjusted, this control fixes the mean pressure at the ET tube/patient connection after about five system time constants have elapsed but only if set bias flow and oscillator characteristics remain unchanged for the same time period. Five time constants will vary from about one second to as long as 30 seconds. This time constant varies inversely with both P_A Control Valve resistance and bias flow setting.

Changes in the following oscillator controls may necessitate readjustment of the mean pressure to maintain a constant P_A : Frequency, % Inspiratory Time, Power (and resultant ΔP change).

Frequency affects the P_A adjustment slightly, but at higher frequencies the amplitude of the oscillator piston movement may be attenuated due to slew rate limiting. (The transit time of the piston is greater than the cycle time required by the Frequency adjustment.)

Since the % Inspiratory Time adjustment affects the symmetry of the oscillatory waveform, it will directly cause a change in the P_A when readjusted.

A change in the ΔP will cause a change in the percent of the P_A contributed by any nonsymmetrical oscillatory waveform. Thus, P_A will change and will need to be readjusted if an unchanged P_A is desired.

With the oscillator off, the Mean Pressure Adjust control is capable of achieving 41 cmH₂O P_A at a Bias Flow of 20 LPM with the patient circuit calibrated to the system. P_A will generally increase moderately with the oscillator running.

Refer to Chapter 6, Operational Verification and Startup Procedures, for an explanation of the Mean pressure setup procedure.

3. (Not used)

4. Power / ΔP

Determines the amount of power that is driving the oscillator piston to and fro. The Power control is a 10-turn, electrical potentiometer covering the power range of 0 to 100%. The knob scale is a 10-turn locking dial that is not calibrated in % power but marked for purposes of establishing reference points.

The effect of this control is to change the displacement of the oscillator piston and hence the oscillatory pressure ΔP .

The Power setting interacts with the P_A conditions existing within the Patient Circuit to produce the resultant ΔP . The ΔP is numerically displayed on the digital meter adjacent to the Power control. At extremely high amplitudes (power settings greater than 6) the oscillatory pressure may significantly contribute to the mean pressure. Changes to the amplitude will result in changes to the mean airway pressure and should be compensated for to maintain an unchanged mean airway pressure.

Refer to Chapter 6, Operational Verification and Startup Procedures, for a description of the adjustment technique for setting the Power control.

5. % Inspiratory Time

Determines the percent of the oscillator cycle time that the piston is traveling toward or is at its final inspiratory position. The control is a 10-turn electrical potentiometer and covers the range of 30 to 50%. The setting is numerically displayed on the digital meter adjacent to the control.

Changing the % Inspiratory Time control could have an effect on the position of the oscillator piston. At higher frequencies, changing the % Inspiratory Time from at or near 50% toward 30% may decrease the displacement. This is due to the fact that the shorter inspiratory phase of the oscillation may not give the piston enough time to travel to its full deflection.

B. Front and Side Panel – Control Package

Since this control affects the symmetry of the oscillatory waveform, it may affect the P_A or the ΔP .

6. Frequency – Hz

Sets the oscillator frequency in Hertz. The control knob is a 10-turn, clockwise increasing, electrical potentiometer covering the range of 3 to 15 Hertz. The set frequency is displayed on the digital meter.

7. Start/Stop

Manually toggles the oscillator between enabled and disabled. If the green LED on this pushbutton is lit, then the oscillator is enabled and pressing the pushbutton will disable the oscillator. If the green LED is not lit, then the oscillator is disabled and depressing the pushbutton will enable it to start oscillating—assuming the start up procedure has been properly executed.

This start up procedure will be discussed in Chapter 6. If not done properly, the system will not allow the oscillator to start. This prevents the patient from experiencing too high or low a P_A .

8. Mean Airway Pressure

Displays the P_A on a digital meter in cmH_2O .

9. Set Max P_A

Determines the level in cmH_2O at which the Max P_A Exceeded Warning Alarm will be indicated. The Maximum P_A level is set by means of a thumb-wheel switch covering the range of 0 to 59 cmH_2O . A mechanical stop has been inserted in the tens column of the thumb-wheel switch to prevent the dial from being turned past the numeral 5.

In the event that the proximal pressure meets or exceeds the set Max P_A alarm setting, an audible and visual alarm will occur, and the ventilator will depressurize the Limit Valve seat pressure. Once the mean airway pressure falls to a level of 12 (± 3) $\text{cm H}_2\text{O}$ below the Set Max P_A setting, the Limit Valve will re-pressurize to its normal operational state. Should the high mean airway condition persist, the alarm will repeat until the condition is resolved. Once corrected the high P_A visual indicator will remain lit to notify the clinician that the alarm was violated. Depress the Reset / Power Failure button to reset the visual indicator.

- + Operating the ventilator with low Bias Flow Rates (<15 lpm) and Low Mean Airway Pressures (<15 cmH₂O), with full power (Maximum Amplitude) may result in a low-pressure dump upon activation of the Max P_A Alarm.

10. Set Min P_A

Determines the level in cmH₂O at which the Min P_A Exceeded Warning Alarm will be indicated. The Minimum P_A level is set by means of a thumb-wheel switch covering the range of 0 to 59 cmH₂O. A mechanical stop has been inserted in the tens column of the thumb-wheel switch to prevent the dial from being turned past the numeral 5.

The activation of the alarm is indicated by a 3K-Hertz modulated tone and a red LED which is adjacent to the thumb-wheel switch.

The alarm will reset automatically after correction of the condition. The audible indicator can be silenced for 45 seconds by pushing the 45-Sec Silence pushbutton.

This alarm does not initiate any machine response other than the activation of the visual and audible indicators.

11. P_A > 60 cmH₂O

The red LED indicates activation of this preset Safety Alarm. It is also indicated by a 3K-Hertz modulated tone. The alarm is reset only by pushing the Reset pushbutton after the alarm condition has been corrected. The 45-Sec Silence pushbutton can be pushed to silence the audible indicator; however, the red LED indicator will still function and the Dump Valve will remain open.

When this alarm occurs, the Model 3100B will automatically shut down the oscillator, but bias flow will continue. The Dump Valve will be open and will hold the airway pressure to near atmospheric. This protects the patient from the elevated pressure and allows the patient to breathe spontaneously. (See the Patient Circuit section in Chapter 3 for further explanation of this feature.)

Because of the Dump Valve activation, the P_A < 5 cmH₂O Safety Alarm will also be activated.

After the correction of the condition that triggered the Safety Alarm, the oscillator startup procedure must be followed for reset. This is discussed in Chapter 6.

B. Front and Side Panel – Control Package

12. $P_A < 5$ cmH₂O

The red LED indicates activation of this Safety Alarm. It is also indicated by a 3K-Hertz modulated tone. This alarm triggers at a $P_A < 5$ cmH₂O. The alarm will reset after the alarm condition has been corrected.

The 45-Sec Silence pushbutton can be pushed to silence the audible indicator; however, the red LED indicator will still function.

When this alarm occurs, the Model 3100B will automatically shut down the oscillator, but bias flow will continue. The Dump Valve will be activated and will hold the airway pressure to near atmospheric. This allows the patient to breathe spontaneously. (See the Patient Circuit section in Chapter 3 for further explanation of this feature.)

After the correction of the condition that triggered the Safety Alarm, the oscillator startup procedure must be followed for reset. This is discussed in Chapter 6.

13. Power Failure

The red LED indicates loss of electrical power or insufficient or inadequate electrical power supply. It is accompanied by a 3K-Hertz modulated audible tone. The following conditions will cause this alarm to trigger:

- a. Tripping of Model 3100B System circuit breaker.
- b. Turning off Power Switch (29).
- c. Power plug being pulled from wall socket.
- d. Loss of power to the hospital branch line to which the Model 3100B System is connected.
- e. A failure in the power supply internal to the Model 3100B System.

Once tripped, the alarm indicators (red LED and 3K-Hz modulated tone) can be reset only by pushing the Reset button (14) even if the power failure condition has been corrected. Then, the oscillator Start/Stop Switch must also be pressed to restart the oscillator.

The Power Failure Alarm circuitry is powered by a battery (25) which will be discussed further in the next section covering operation of controls, indicators, and connections on the rear panel of the Control Package.

14. Reset Pushbutton

This momentary pushbutton resets all Safety Alarms and the Power Failure alarm.

The alarm conditions triggering the > 60 cmH₂O and < 5 cmH₂O Safety Alarms (11 and 12) must first be corrected before resetting will occur. Since these

alarms cause the Dump Valve to open, Reset must be held in with the Start/Stop enabled until the Dump Valve closes and airway pressure builds above the 5 cmH₂O P_A level.

The Power Failure alarm (13) will be reset regardless of whether the alarm condition has been corrected or still exists.

It is normal for the Battery Low LED to light when the reset button is pressed.

15a. Battery Low

Indicates the Power Failure alarm battery (25) on the rear panel of the Control Package must be changed as soon as possible to ensure continued proper operation of the Power Failure alarm.

15b. Source Gas Low

Indicates the gas pressure at the “Inlet From Blender” or “Air Cooling” connection has fallen below 30 psig.

Since the Battery Low and Source Gas Low are classified as caution alarms, yellow LEDs are used, and there is no audible indicator. These alarms will reset only after the battery has been replaced by a new one or the source gas pressure increases above 30 psig, respectively.

The user should investigate the cause of the alarm. If the problem is a loss in blender output pressure, the Warning or Safety Alarms will soon be activated. If the problem is a loss of oscillator cooling air, the Oscillator Overheated alarm will soon activate. This alarm can occur due to plugging of an Inlet Filter Cartridge with dirt. Refer to the Operator Maintenance Procedures section of Chapter 7 for instructions on changing the Inlet Filter Cartridges.

The battery will be discussed further in the next section covering the operation and location of the rear panel controls, indicators, and connections.

B. Front and Side Panel – Control Package

- 16. Oscillator Overheated** Indicates that the oscillator coil is overheated and has reached approximately 150°C. Since this is a Caution Alarm, a yellow LED is used, and there is no audible indicator. This alarm will reset only after the condition has been corrected. The operator should determine if the problem is a loss of, or decrease in, cooling gas pressure. This could be caused by low gas pressure at its source, an occlusion (such as a kinked tube or plugged Inlet Filter Cartridge) or a loose tube connection, internal or external. Refer to the Operator Maintenance Procedures section of Chapter 7 for instructions on changing the Inlet Filter Cartridges.
- 17. Oscillator Stopped** Indicates that the oscillator is enabled (Start/Stop pushbutton green LED lighted) but $\Delta P < 5$ to 7 cmH₂O. A red LED indicator is accompanied by a 3K-Hertz modulated tone. No machine action is taken other than the indicators which automatically reset when the condition is corrected.
- 18. 45-Sec Silence Pushbutton** Activates and indicates the inhibiting of the audible alarm, for a period of 45 seconds. This control is a lighted pushbutton and indicates a caution with its yellow LED when pushed. Once activated, the 45-Sec Silence cannot be reset, but must time out.
- 19. Patient Circuit Calibration** Adjusts the maximum mean pressure that can be obtained with a specific Patient Circuit. This screwdriver adjustment is used to calibrate the maximum mean pressure after the Patient Circuit is changed or the P_A Control diaphragm is changed. A full setup procedure is detailed in Chapter 7, Maintenance and Troubleshooting.

C. Rear Panel – Control Package

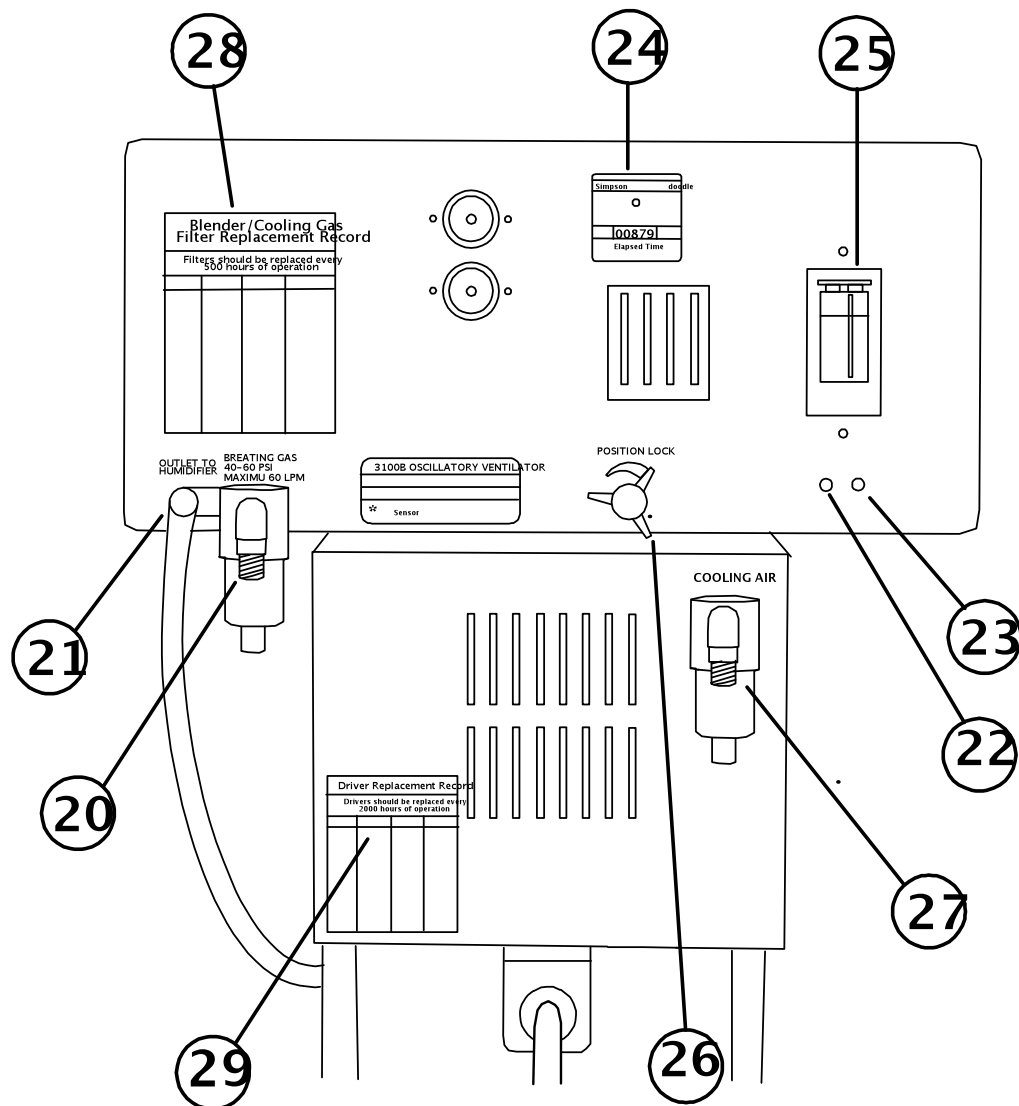

Figure 4.2. Rear Panel Controls, Indicators, and Connections.

The numbers shown on Figure 4.2 correspond to the numbers on the following descriptions. Details concerning specific design characteristics are discussed in Chapter 2.

C. Rear Panel – Control Package

- 20. Inlet From Blender** DISS oxygen fitting for connection to an inline Inlet Filter Cartridge and then to the External Air/O2 Blender output. The nominal pressure of the blender output gas should be 50 psig. The Source Gas Low yellow LED will light if the pressure at the inlet drops below 30 psig $\pm 5\%$.
- This input connection is protected from over-pressure by a 75 psig mechanical relief valve. More details regarding this protection are listed in Chapter 2.
- 21. Outlet To Humidifier** Connector which provides bias flow to the inlet of the External Humidifier. This is a 3/8" barbed fitting which is over-pressure protected by a 5 psig mechanical relief valve. The Patient Circuit assembly procedures associated with this connector are discussed in Chapter 5.
- 22. Pressure Transducer Zero Adjustment** See Chapter 7.
- 23. Pressure Transducer Span Adjustment** See Chapter 7.
- 24. Elapsed Time Meter** Indicates the total accumulated time in hours that power has been applied to the Model 3100B. Detailed specifications of this meter are discussed in Chapter 2.
- 25. Power Failure Alarm Battery And Battery Compartment** A metal cover (fastened by 2 screws) behind which is a 9-volt alkaline battery. Battery Low LED (15) on front panel indicates when this battery needs to be changed. It can be replaced by any high quality 9-volt alkaline battery. Note: remove the 9-volt battery if the instrument is not intended to be used for a lengthy period.
- 26. Position Lock** Locks the Control Package in the rotational position selected by the user. When this lock is rotated counterclockwise, it allows the rotation of the Control Package over an arc of nearly 360° . This permits viewing of the Model 3100B front panel from an angle independent of the Patient Circuit outlet orientation.
- After the desired position has been selected, rotation of the knob in a clockwise direction will lock the enclosure in the selected position.

Rotation of the knob slightly counterclockwise from fully locked will apply friction to prevent the enclosure from easily being rotated without actually fixing it in place.

More on the subject of positioning of controls is discussed in Chapter 5, Assembly.

27. Air Cooling Inlet

An Air DISS fitting for connection through an in-line Inlet Filter Cartridge to hospital air supply which provides the oscillator with cooling gas. The nominal pressure of the hospital air should be 50 psig at the required 25 LPM rate. The Source Gas Low yellow LED will light if the pressure at the inlet drops below 30 psig $\pm 5\%$.

**28. Blender/Cooling Gas Filter
Replacement Record**

During normal maintenance as described in Chapter 7, record the reading on the Elapsed Time Meter for quick reference.

29. Driver Replacement Record

During normal maintenance as described in Chapter 7, record the reading on the Elapsed Time Meter for quick reference.

D. System Column and Patient Circuit

D. System Column and Patient Circuit

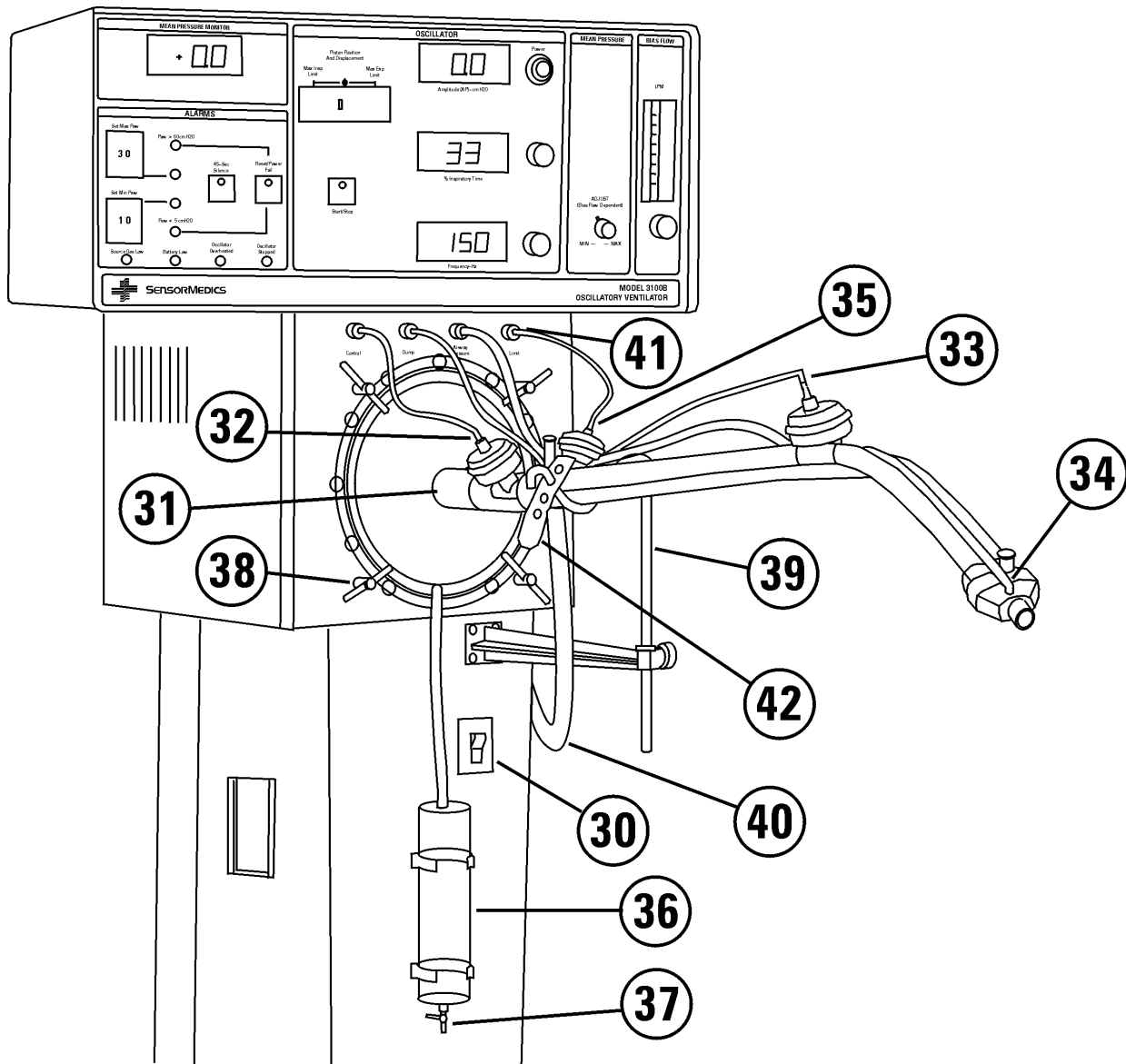

Figure 4.3. System Column and Patient Circuit Controls and Connections.

The numbers shown on Figure 4.3 correspond to the numbers on the following descriptions.

Precaution

Care should be taken not to crimp or perforate any of the control or sensing lines (running to or from the Patient Circuit) during assembly or operation of the ventilator as this will cause malfunction of the Safety Alarms, Warning Alarms, Caution Alarms, and/or Pressure Limit controls.

30. Power Switch

Turns power to the Model 3100B System on and off. This power switch also functions as a circuit breaker in case of a power overload. If the circuit breaker trips, be sure to locate the problem causing the power overload before resetting the breaker. This switch is a standard rocker switch which breaks both sides of the power line as does the built-in circuit breaker.

**31. Oscillator Compartment
(Bellows)**

Attaches to 1 1/4" I.D. inspiratory limb of patient circuit and is held in place by four quarter-turn fasteners.

32. P_A Control Valve Control

Green Luer bulkhead fitting for connection to green 1/16" I.D. tubing that runs to the control input of the P_A Control Valve on the Patient Circuit. Consult assembly procedure in Chapter 5 for details on attachment of this control line to its valve. This line should be replaced periodically during scheduled preventive maintenance of the HFOV.

33. Dump Valve Control

Red Luer bulkhead fitting for connection to red 1/16" I.D. tubing that runs to control input of Dump Valve on Patient Circuit. Consult assembly procedure in Chapter 5 for details on attachment of this control line to its valve. This line should be replaced periodically during scheduled preventive maintenance of the HFOV.

34. P_A Sense

White Luer bulkhead fitting for connection to clear 1/8" I.D. tubing that runs to the Airway Pressure Port of the Patient Circuit for the purpose of transmitting the P_A signal to the pressure transducer within the Control Package. Consult assembly procedure in Chapter 5 for details on attachment.

35. P_A Limit Valve Control

Blue Luer bulkhead fitting for connection to blue 1/16" I.D. tubing that runs to control input of P_A Limit Valve on Patient Circuit. Consult assembly procedure in

D. System Column and Patient Circuit

Chapter 5 for details on attachment of the control line to its valve. This line should be replaced periodically during scheduled preventive maintenance of the HFOV.

36. Water Trap

Condensate should drain into the water trap if the Patient Circuit is positioned properly. There is a small (.025" diameter) hole at the top of the water trap to allow air to escape as it fills.

37. Water Trap Drain Valve

Allows draining of water condensate. Water is drained from the bottom when the stopcock is opened. The contents of the water trap can be drained while the Model 3100B is still operating as long as the water seal between the ventilator and the bottom drain is not broken. This can be accomplished by always leaving a small amount of water at the bottom of water trap after draining. Follow the instructions in Chapter 7 regarding cleaning and disinfecting the water trap and valve mechanisms.

Precaution
Ensure that the stopcock is closed prior to performing a Patient Circuit Calibration. If the Water Trap Stopcock is left open, Patient Circuit Calibration (39–43 cmH ₂ O) may not be achievable, and the deliverable P _A will be reduced.

38. Bellows Fasteners

Four quarter-turn fasteners that hold the bellows (Oscillator Compartment) in place in front of the oscillator piston.

39. Patient Circuit Cradle

For attachment of Patient Circuit. Refer to Chapter 5 for assembly and adjustment instructions.

40. Humidifier Tubing

The external humidifier is connected between the "Outlet To Humidifier" on the rear of the Control Package and the Bias Flow Inlet on the Patient Circuit. In Figure 4.3, the humidifier tubing is shown connected to the patient circuit without the humidifier inline.

Only the 3/8" tube supplied with the Patient Circuit should be used.

41. Bulkhead Luer Fittings

There are four bulkhead luer fittings on the front of the oscillator compartment for connection to the three valve caps and pressure sense port on the patient circuit.

42. Hold Down Strap

Secures the patient circuit to the Patient Circuit Cradle. This keeps the circuit in a stable position.

A. Introduction

A. Introduction

This chapter covers the unpacking, assembly, and installation of the Model 3100B HFOV prior to operational verification. The Control Package is shipped already attached to the Column. The assembly of the Patient Circuit and its attachment to the rest of the ventilator is illustrated in Figures 5.1 and 5.2.

B. Unpacking

The Model 3100B HFOV is shipped in one crate, containing the instrument (pre-assembled control package, column, and pedestal) and several smaller cartons containing:

1. Patient Circuit support arm and cradle.
2. Two complete patient circuits, packaged one to a box.
3. Humidifier input and output hoses/adapters.
4. A box of ten spare Inlet Filter cartridges for blended gas and air inputs.
5. Operator's Manual.
6. Humidifier mounting bracket adapters.

C. Assembly

Precaution

Deviation from the assembly methods described here could damage the Model 3100B, render it mechanically unstable, or cause it to malfunction. If any questions arise regarding the assembly procedure, please contact SensorMedics Technical Support immediately before proceeding.

Place the pre-assembled Control Package, Column, and Pedestal on a level floor and lock the locking wheels.

Assemble the Patient Circuit support arm prior to attempting to attach the Patient Circuit. A flathead screwdriver will be necessary.

Precaution

When connecting the Patient Circuit, make certain that it is properly supported by the support arm. Failure to do so could result in inadvertent Patient Circuit disconnection due to oscillatory forces or could result in collection of humidifier condensate in the patient airway.

C. Assembly

Attach the vertically-adjustable rod to the end of the support arm so that it will cradle, in its curved end, the main tube of the Patient Circuit. Tighten the thumbscrew crosspiece to secure it at the height desired.

The angle of the Patient Circuit can also be controlled by loosening the thumbscrew on the cradle rod and sliding it either up or down. Once again, always be certain to retighten the thumbscrew.

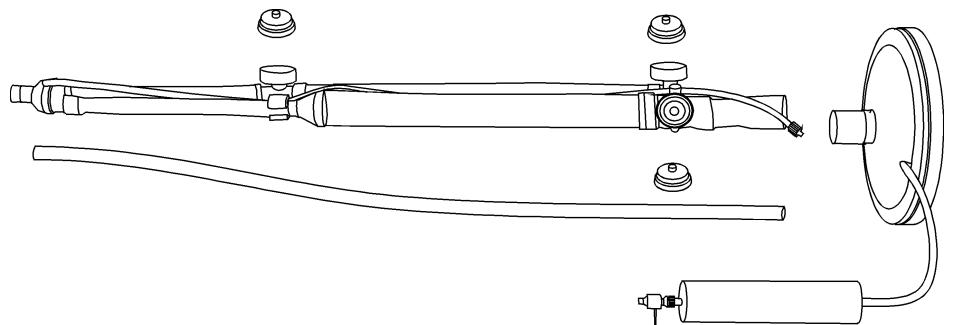

Figure 5.1. Disassembled Patient Circuit.

C. Assembly

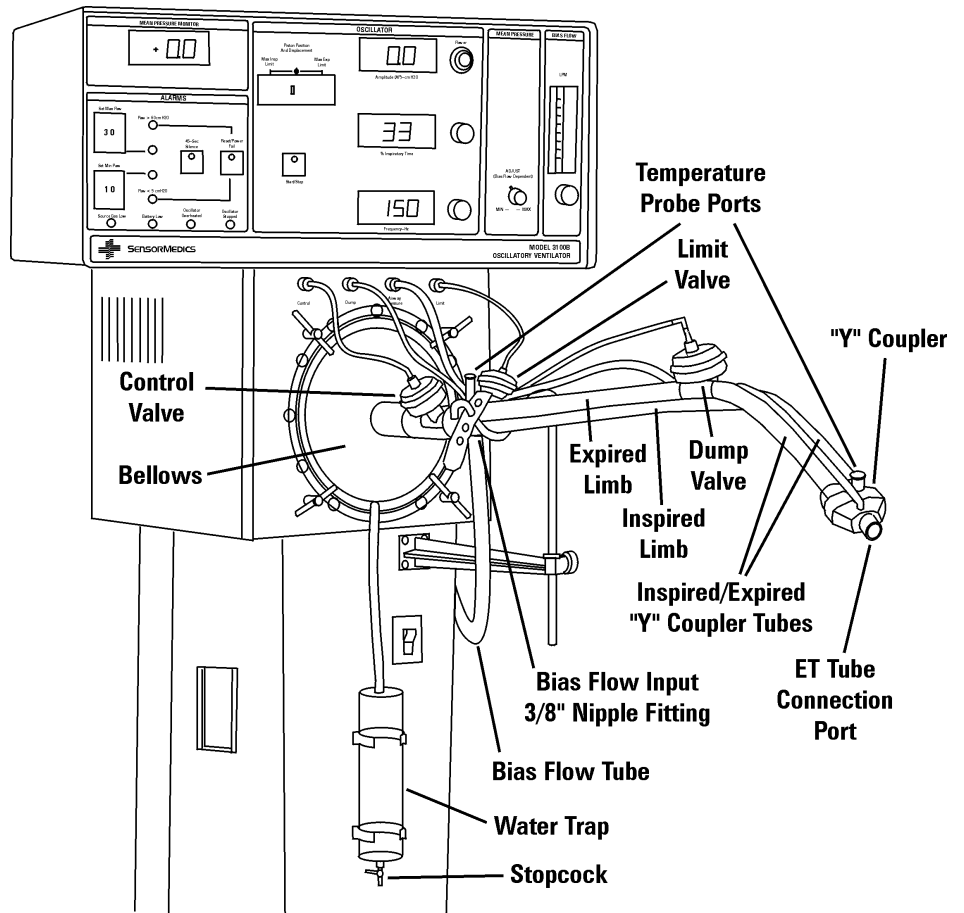

Figure 5.2. Details of Patient Circuit.

Assemble the Patient Circuit using Figures 5.1 and 5.2 as a guide. Connect the Patient Circuit Body to the Bellows/Water Trap Assembly and snap the three identical caps/diaphragm assemblies onto the three valve bodies located on the Patient Circuit Body.

Next, attach this assembled Patient Circuit to the face of the Oscillator Compartment using the four captive T-handle quarter-turn fasteners.

Precaution

The driver diaphragm of the 3100B has been coated with a special lubricant during assembly. Please do not clean the driver diaphragm with cleaning solvents as it may degrade the materials causing premature wear of the driver diaphragm.

Attach the three color-coded tubes to their corresponding valve caps, using the following color-coding scheme:

Color of Line	Patient Circuit Attachment Point
Blue	Limit Valve
Green	P _A Control Valve
Red	Dump Valve
Clear	P _A Sensing Port

Note that the differing lengths and color coding of the tubes and the physical arrangement of the valves within the Patient Circuit minimize any cross-connection.

Precaution

Care should be taken not to crimp or perforate any of the control or sensing lines (running to or from the Patient Circuit) during assembly or operation of the ventilator, as this will cause malfunction of the Safety Alarms, Warning Alarms, Caution Alarms, and/or Pressure Limit controls.

Next, attach the 1/8"-Tygon pressure-sense line (captive to the Patient Circuit "Y") to the bulkhead Luer fitting marked "Airway Pressure." Finally, insert the humidifier temperature probe in the tapered-opening near the patient "Y." Note that an identical such port with a removable plug in it is located at the opposite end of the Patient Circuit. Always insert the plug in the unused port.

C. Assembly

Precaution

If the temperature probe is wiped with alcohol, allow the alcohol to evaporate completely before inserting it into the circuit. A high residual of alcohol can weaken the acrylic adapter and cause fracturing.

Always insert the provided plug into the unused temperature probe port. Failure to do so will allow a leak of sufficient magnitude that the minimum P_A necessary to allow the oscillator to start cannot be achieved.

Use the cradle rod adjustment already described to maintain the proper Patient Circuit height and angle. The proper angle will allow condensate to run downward into the Water Trap mounted on the Column.

The 3100B High Frequency Oscillating Ventilator is now ready for Operational Verification and Start-Up (see Chapter 6).

Warning

Do not attempt to substitute a circuit configuration from any other instrument. Use of a non-3100A or a non-3100B circuit can result in injury to the patient or to the operator, and it may cause damage to the equipment. The Patient Circuit described in this manual is specifically designed for patient use with the Model 3100B HFOV.

C. Assembly

Obtain an External Air/O₂ Blender and an External Humidifier for incorporation into the system as described in Chapter 3. Attach these devices to the Patient Circuit using the attachment accessories supplied and using Figures 5.1 and 5.2 as a guide. The following connections must be made:

Device	Input Connection(s) From	Output Connection To
Air/O ₂ Blender	(a) Hospital Air DISS connection (b) Hospital Oxygen DISS connection	Control Package rear panel "INLET FROM BLENDER" DISS fitting
Humidifier	Control Package rear panel "OUTLET TO HUMIDIFIER" 3/8" barbed fitting	Patient Circuit Bias Flow Connection 3/8" nipple fitting

There is an additional connection from the Hospital AIR DISS connection to the Column DISS Air fitting marked "AIR COOLING."

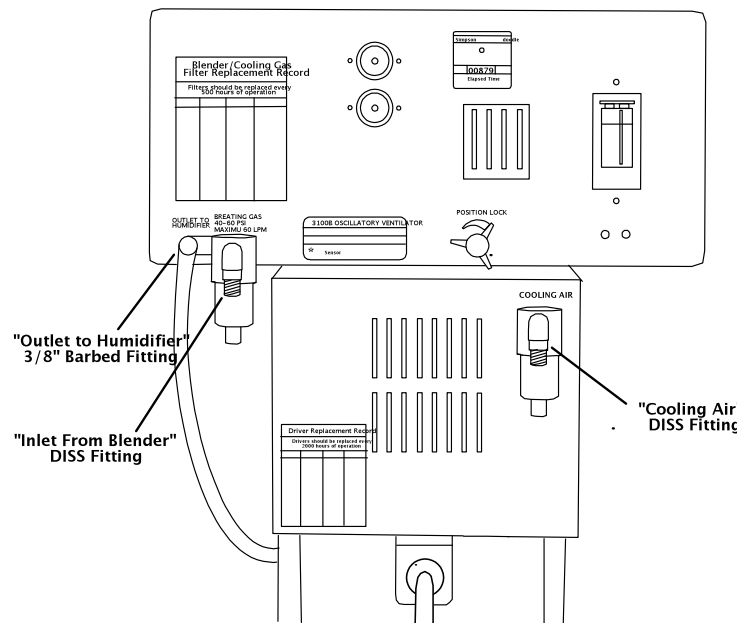

Figure 5.3. Rear Panel Connections.

C. Assembly

Warning

Do not shorten the 30" bias flow tube provided with the patient circuit, as this may reduce the maximum ΔP by allowing the oscillatory pressures to be attenuated by closer proximity to the volume of the humidifier canister.

Precaution

The inlet filter cartridges for the blended gas and the air inputs to the ventilator must be replaced at least every 500 hours of operation as described in Chapter 7, Maintenance and Troubleshooting. Failure to replace a filter cartridge or substitution of an unauthorized cartridge could result in injury to the patient and/or damage to the equipment. Use only SensorMedics P/N 463110 cartridges (P/N 767163 box of 10).

Find a convenient power outlet for connection to the Model 3100B with a minimum rating compatible with the HFOV power ratings described in Chapter 2.

The Model 3100B HFOV system is now ready for operational verification.

Warning

Do not attempt to defeat the proper connection of the ground wire. Improper grounding may cause damage to the device or interconnected equipment and could be injurious to the patient or to those associated with the device use. This device is factory equipped with a hospital-grade AC power plug. Grounding reliability can only be assured when connected to a tested receptacle labeled "Hospital Grade."

Precaution

Proper operation of the ventilator must be verified prior to each use. Refer to Chapter 6, Operational Verification and Start-up Procedures.

D. Pre-use Cleaning and Disinfection

Warning

Do not operate radio transmitters within 20 feet of this instrument. This may result in erroneous pressure readings leading to false alarms and automatic shut-down.

**D. Pre-use Cleaning
and Disinfection**

The 3100B requires no preliminary cleaning before initial use. The Patient Breathing Circuit components, though clean, are not shipped sterile. If desired, the circuit body may be disinfected before using according to the instructions in the “Changing the Patient Circuit” section of Chapter 7, Maintenance and Troubleshooting.

A. Introduction

A. Introduction

This chapter covers the proper operational verification and ventilation start-up methods for the Model 3100B HFOV.

- + See Chapter 5 for instructions on unpacking, assembly, and installation of the Model 3100B HFOV prior to operational start-up and verification.

Warning

The operational verification and start-up procedure must be followed before ventilation of a patient commences. If at any time during the operational verification and start-up procedure any abnormal function of the Model 3100B HFOV is noted, do not proceed with patient ventilation as this could cause patient injury or death; immediately contact SensorMedics Technical Support before proceeding any further.

Precaution

Proper operation of the ventilator must be verified prior to each use. The alarm functions tested in this procedure verify the capability of the device to detect and indicate conditions which could have a harmful effect on the patient.

Precaution

Touch the outer metal cabinet of the instrument before touching any other component to avoid possible instrument component damage from Electrostatic Discharge.

Warning

Do not operate radio transmitters within 20 feet of this instrument. This may result in erroneous pressure readings leading to false alarms and automatic shut-down.

B. Start-up Procedures

B. Start-up Procedures

1. Connect the source gases to the Model 3100B HFOV System:
 - a. Oxygen line to the External Air/O₂ Blender oxygen input fitting
 - b. Air line to the External Air/O₂ Blender air input fitting and the oscillator “Air Cooling” input connector.
 - c. External Air/O₂ Blender output to the Control Package rear panel oxygen DISS fitting labeled “Inlet from Blender.”
2. Connect Patient Circuit and External Humidifier to the Model 3100B using the assembly procedures described in Chapter 5.

Warning

Do not attempt to substitute a circuit configuration from any other instrument. Use of a non-3100A or a non-3100B circuit can result in injury to the patient or to the operator, and it may cause damage to the equipment. The Patient Circuit described in this manual is specifically designed for patient use with the Model 3100B HFOV.

Precaution

When connecting the Patient Circuit, make certain that it is properly supported by the support arm as described in Chapter 5, Assembly and Installation. Failure to do so could result in inadvertent patient circuit disconnection due to oscillatory forces or could result in collection of humidifier condensate in the patient airway.

3. Connect all color-coded Patient Circuit Control Lines and the clear Pressure Sense Line to their proper locations on the Patient Circuit as described in Chapter 5.

Precaution

Care should be taken not to crimp or perforate any of the control or sense lines (running to or from the Patient Circuit) during assembly or operation of the ventilator as this will cause malfunction of the Safety Alarms, Warning Alarms, Caution Alarms, and/or Pressure Limit controls.

B. Start-up Procedures

4. Block off or obstruct the ET connection port on the Patient Circuit using the #1 rubber stopper accessory provided.
5. Turn on the Main Power Switch (the green LED on the Start/Stop pushbutton should be off). Some of the alarm LED's will be lit when power is first turned on.

Warning

An audible alarm indicates the existence of a condition potentially harmful to the patient and should not go unattended. Failure to respond to alarms could result in injury, including death, to the patient and/or damage to the ventilator.

Precaution

Ensure that the stopcock is closed prior to performing a Patient Circuit Calibration. If the Water Trap Stopcock is left open, Patient Circuit Calibration (39–43 cmH₂O) may not be achievable, and the deliverable P_A will be reduced.

Warning

Ensure that the cooling fan at the rear of the driver enclosure is operational.

6. Calibrate the patient circuit to the system. (These instructions are also located on a label on the side of the Control Package).
 - a. Turn on source gas pressure and establish Bias Flow at 20LPM. Be sure to read the flow at the center of the ball, looking level at the flow meter.
 - b. Set Max P_A Alarm to 59 cmH₂O.
 - c. Set Mean Pressure Adjust control to Max (full CW).
 - d. Push in and hold RESET while observing the Mean Pressure digital readout. It is normal for the Battery Low LED to light when the reset button is pressed.
 - e. Adjust the Patient Circuit Calibration on the right side of the control package to achieve a P_A of 39 to 43 cm H₂O. Do not overturn; if the specified pressure can not be achieved, locate the leak.
 - f. Release the RESET button; the Battery Low LED should turn off.

B. Start-up Procedures

Precaution

Do not overturn the Patient Circuit Calibration as this may cause damage to the device. When it is nearing its adjustment limit, it will reach a mechanical stop.

7. Perform the Ventilator Performance Check “Off Patient Only” section. (These instructions are also located on a label on the top of the Control Package).
 - a. Insert stopper in Patient Circuit “Y” and turn on both gas sources.
 - b. Set BIAS FLOW for 30 LPM.
 - c. Set Max P_A Alarm to 35 cmH₂O.
 - d. Pressurize system by pressing and holding RESET, and ADJUST for a mean Pressure of 29-31 cmH₂O.
 - e. Set FREQUENCY to 6, % I-Time to 33, and press START/STOP to start the oscillator.
 - f. Set POWER to 6.0.
 - g. When a stable ΔP reading is obtained, verify that the ΔP and P_A readings are within the range specified for your corresponding altitude (see Figure 6.1).
8. Depress the START/STOP button to stop the oscillator.
9. With Mean Pressure Adjust and/or Bias Flow adjustment, achieve a mean airway pressure within 2 cmH₂O of the desired level. Ensure that the Bias Flow is sufficient (see Chapter 8).
10. Verify the function of the thumb-wheel switches for “Set Max P_A ” and “Set Min P_A ” alarms by setting the Max thumb wheel just below the established Mean pressure, and by setting the Min thumb wheel just above the established Mean pressure.
11. Set these thumb-wheel alarm switches to their desired settings. This is generally 2–5 cmH₂O above (Max thumb-wheel) and below (Min thumb wheel) the established Mean pressure.
12. With fingers and thumb(s), squeeze closed the 1/8" clear Pressure Sense tubing on the patient circuit to verify operation of the “ $P_A > 60$ cmH₂O” alarm.

B. Start-up Procedures

13. Depress the RESET button until the “ $P_A < 5 \text{ cmH}_2\text{O}$ ” LED is extinguished to reestablish the mean airway pressure.
14. Again, squeeze the pressure sense tubing on the patient circuit and observe the pressure at which the Mean Pressure display limits.
15. Position the ventilator for connection to the patient. Loosen the Position Lock control and adjust the angle of the Control Package for the best view and access relative to the patient. Retighten the Position Lock.
16. Set the desired % oxygen, Mean Pressure, and ΔP for the patient. ΔP will affect the P_A depending on ratio of Flow Rate/ P_A . The lower the ratio, the stronger the effect.

Precaution

Fractional concentration of inspired oxygen should be verified with an oxygen monitor. Administration of excessive oxygen to a patient may be harmful. It is imperative that the prescribed gas mixture is delivered by the blending system.

17. Remove the Patient Circuit stopper. Adjust the External Humidifier to establish the desired gas temperature at the patient airway temperature port. Connect the Patient Circuit to the patient ET tube.

Warning

Under no circumstances should proximal airway gas temperature of 41°C be exceeded. This could result in injury to the patient's upper airway membranes.

Warning

Do Not use the 3100B ventilator in environments where the ambient temperature is at or above 84°F (28°C). Use of the ventilator in these environments will result in extreme reduction in relative humidity in the patient's airway and possible desiccation of the patient airways.

B. Start-up Procedures

Precaution

When the ventilator is connected to a patient, it is imperative that someone be in attendance at all times in order to react to any alarms and to detect other indications of a problem.

18. Push the Reset pushbutton until the “ $P_A < 5 \text{ cmH}_2\text{O}$ ” LED is extinguished to reestablish Mean Pressure.
19. Set the Power control for the desired ΔP (see Chapter 8).
20. Readjust the Frequency, % Inspiratory Time, Power, Mean Pressure, and Bias Flow as needed during patient ventilation.

Warning

Under no circumstances should the ventilator be used in the presence of flammable anesthetics due to the possibility of explosion.

Precaution

Do not place on the Control Package of the ventilator any fluid-containing accessories, accessories that weigh more than 10 pounds, or accessories that extend more than six inches above the ventilator electronics package or beyond its sides. This could cause the ventilator to tip over, resulting in patient or user injuries and/or damage to the equipment.

C. Performance Verification

C. Performance Verification

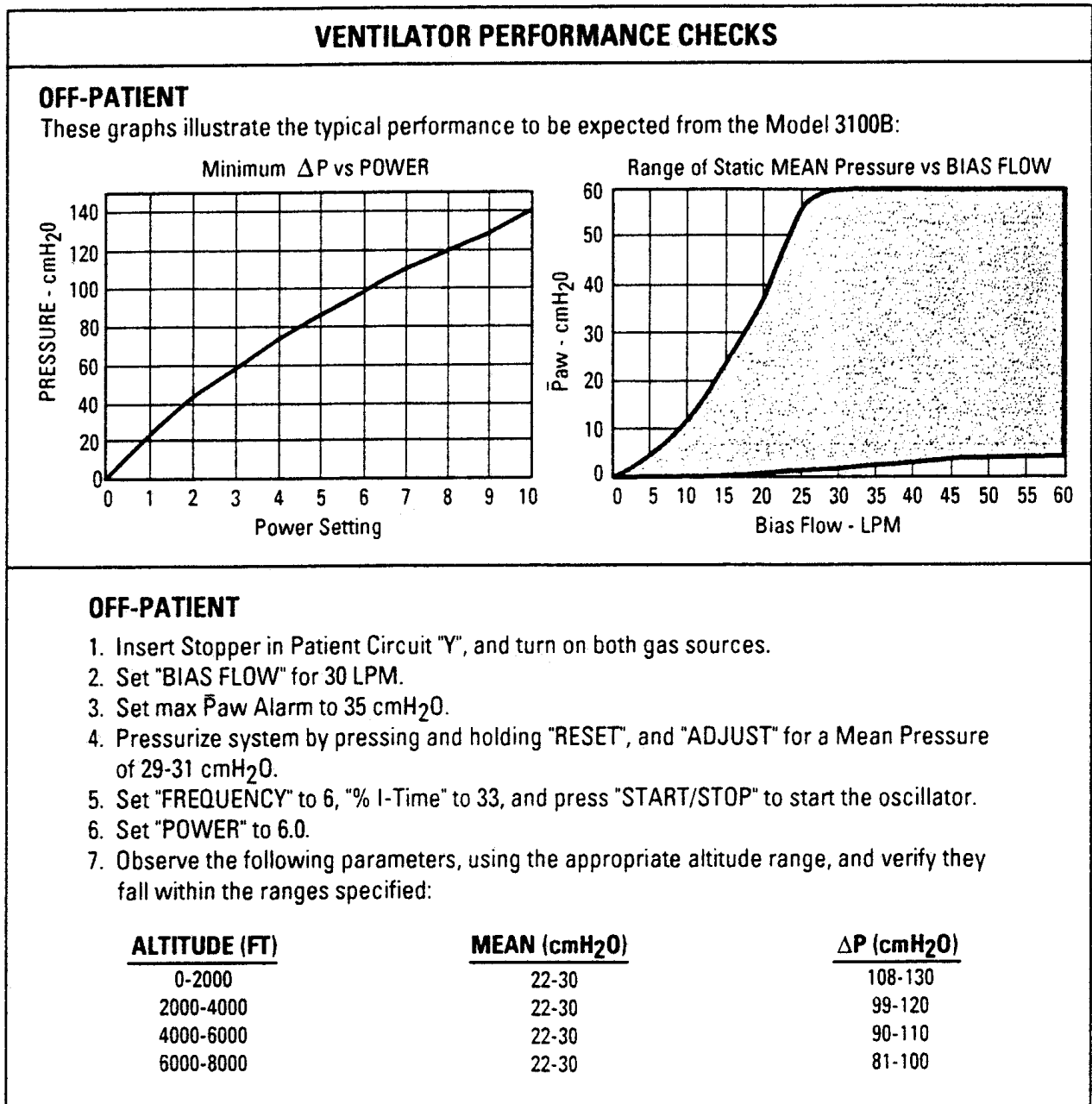

767165-101F

Figure 6.1. Ventilator Performance Checks.

C. Performance Verification

The two graphs shown in Figure 6.1 are intended to guide the operator in setting Power, Mean Pressure Adjust, and Bias Flow controls, and to help ascertain that the 3100B is performing in a typical fashion without problems.

The left graph indicates the approximate setting of the Power control required to achieve a specific ΔP pressure. The right graph illustrates the Bias Flow required to achieve a range of Mean pressures with the single-turn Mean Pressure Adjust control.

In establishing a specific Mean pressure, find the required Bias Flow that will allow the Mean pressure to be adjusted above and below that desired. Set the Mean Pressure Adjust control to approximately “twelve o'clock” and set the Bias Flow as indicated on the graph, to a level which puts the desired P_A level in its mid-range. When the system is operating, whether ON or OFF Patient, the settings of the controls relative to the pressures being developed and displayed, will quickly give an indication that the system performance is nominal.

A. Introduction

A. Introduction

This chapter covers the Model 3100B maintenance and troubleshooting procedures with which the operator and service technician should be acquainted.

- + SensorMedics or its official representative will make available upon request such circuit diagrams, component part lists, descriptions, calibration instructions or other information which will assist **factory-qualified** technical personnel to repair those parts of the equipment which are classified as repairable. If you are interested in factory training, please contact the SensorMedics Service Department for scheduling and pricing of our biomedical training classes.

Warning

Failure to comply with the recommended maintenance procedures described in this chapter could result in injury to the patient or operator or could result in damage to the equipment.

B. Exterior Cleaning

When surface cleaning of the 3100B is desired, we recommend using a weak disinfectant liquid to wipe down the exterior of the instrument. Do not spray liquid cleaners directly on the exterior surface; spray the cleaning cloth and wring it nearly dry before wiping. **Do not** allow liquids to drip into the instrument.

- + Do not use alcohol or sterilization liquids on the exterior surface of the 3100B.
- + Do not use abrasive cleaners or solvents on the exterior surface of the 3100B.

C. Operator Maintenance Procedures

The operator maintenance procedures are the following:

- Emptying the Water Trap.
- Changing the Compressed-gas Inlet Filter Cartridge Elements.
- Changing the Power Failure Alarm battery.
- Cleaning the Column Lint Filter.
- Changing the Patient Circuit.

- Lubricating the driver diaphragm.

C. Operator Maintenance Procedures

Emptying the Water Trap

The Water Trap must be emptied as described below.

Precaution

The Water Trap must be drained at intervals. If the ventilator is operating, leave a small amount of water at the bottom of the Water Trap container to act as a flow and pressure seal between the ventilator and the output of the drain.

Opening the stopcock on the bottom of the water trap will open the drain. The contents of the water trap should be emptied into a disposable cup or a container which can be subsequently disinfected.

When the Model 3100B is not operational, the Water Trap container can be completely emptied.

Precaution

Ensure that the stopcock is closed prior to performing a Patient Circuit Calibration. If the Water Trap Stopcock is left open, Patient Circuit Calibration (39–43 cm H₂O) may not be achievable, and the deliverable P_A will be reduced.

Changing the Compressed-gas Inlet Filter Cartridge Elements

The 0.1 micron Inlet Filter Cartridges are placed at the input of both the Inlet From Blender DISS oxygen fitting and the Air Cooling Inlet DISS air fitting. Their purpose is to capture any dirt particles or moisture before entry into the Model 3100B HFOV.

Precaution

The Inlet Filter Cartridges for the blended gas and the air inputs to the ventilator must be replaced at least every 500 hours of operation as described in this chapter. Failure to replace a Filter Cartridge or substitution of an unauthorized cartridge could result in injury to the patient and/or damage to the equipment. Use only SensorMedics cartridges (P/N 767163 box of 10).

The recommended minimum change interval is every 500 hours of operation. However, the level of contaminants in the gas lines of your hospital may be higher than normal. If the Model 3100B HFOV is used for the first time at a new location within your hospital, Filter Cartridges should be checked for flow-limiting

C. Operator Maintenance Procedures

contaminants after 100 hours of operation, and then after 300 hours of operation, to determine whether or not a 500 hours of operation change interval is appropriate.

A Filter Cartridge which has been allowed to accumulate flow limiting contaminants will cause the gas supply pressure at the particular DISS fitting to drop. Eventually, the Source Gas Low alarm will trigger. Refer to Chapter 4 for a description of this alarm indication.

Cartridge Change Procedure

The procedure for changing a cartridge is as follows:

1. Turn off and disconnect both the air and oxygen source gas lines.
2. Unscrew body of inlet filter.
3. Remove old cartridge.
4. Install new cartridge. (A box of 10 spare cartridges, part number 767163, is shipped with the Model 3100B as an accessory.)
5. Screw filter back together.
6. Record the Elapsed Time Meter reading on the rear of the 3100B.

Precaution

The filter cartridge body must be screwed back on securely. Cross-threaded or loose installation will result in leaks and possible dislodging of the cartridge body. If the cartridge body is dislodged, it will cause the ventilator to cease functioning.

Changing the Power Failure Alarm Battery

When the yellow Battery Low LED Caution Alarm on the front panel of the Control Package is lighted, the problem is the Power Failure Alarm battery. It should be changed as soon as possible. Access to this battery is gained through the access door on the rear panel. A good quality 9 volt alkaline battery should be used.

Cleaning the Column Lint Filter

After each patient, inspect and clean the lint filter in the Column of the Model 3100B HFOV. Remove the filter element from its holder on the column rear. Shake dirt out, wash it in warm sudsy water, dry it out and replace it in the holder. Failure to perform this procedure will eventually cause a significant restriction of air cooling flow to the oscillator square-wave driver. This could lead to overheating of the driver and eventual malfunction of the oscillator.

C. Operator Maintenance Procedures

Changing the Patient Circuit

Change the Patient Circuit with the same frequency as your institution's policy requires for conventionally-ventilated patients. Dispose of the three snap-off Cap/Diaphragms and the Bellows/Water Trap Assembly; **these items absolutely cannot be reused**. The Patient Circuit Body is intended for single-patient use.

Due to the high power settings which may be encountered, the cap diaphragms of the patient circuit should be changed at least every three days. Failure to do so may cause mean airway pressure instability.

Precaution

The driver diaphragm of the 3100B has been coated with a special lubricant during assembly. Please do not clean the driver diaphragm with cleaning solvents as it may degrade the materials causing premature wear of the driver diaphragm.

Lubrication of the Driver Diaphragm

The oscillating mechanism of the 3100B ventilator consists of a linear motor which drives a piston assembly. Due to the loads which can be placed on the piston assembly, the driver diaphragm must be lubricated every 500 hours of operation. This maintenance procedure will reduce wear on the driver diaphragm and prolong its operational life.

Driver Lubrication Procedure

1. Turn off the ventilator and remove the patient circuit.
2. Utilizing a lint free cloth or towel, wipe the surface of the driver diaphragm to remove any contaminants and any residual lubricant.
3. Use a cotton tipped applicator or the finger of a gloved hand, to apply a thin film of SensorMedics approved lubricant to the entire surface of the driver diaphragm (Figure 7.1).
4. Record the Elapsed Time Meter reading on the rear of the 3100B.

C. Operator Maintenance Procedures

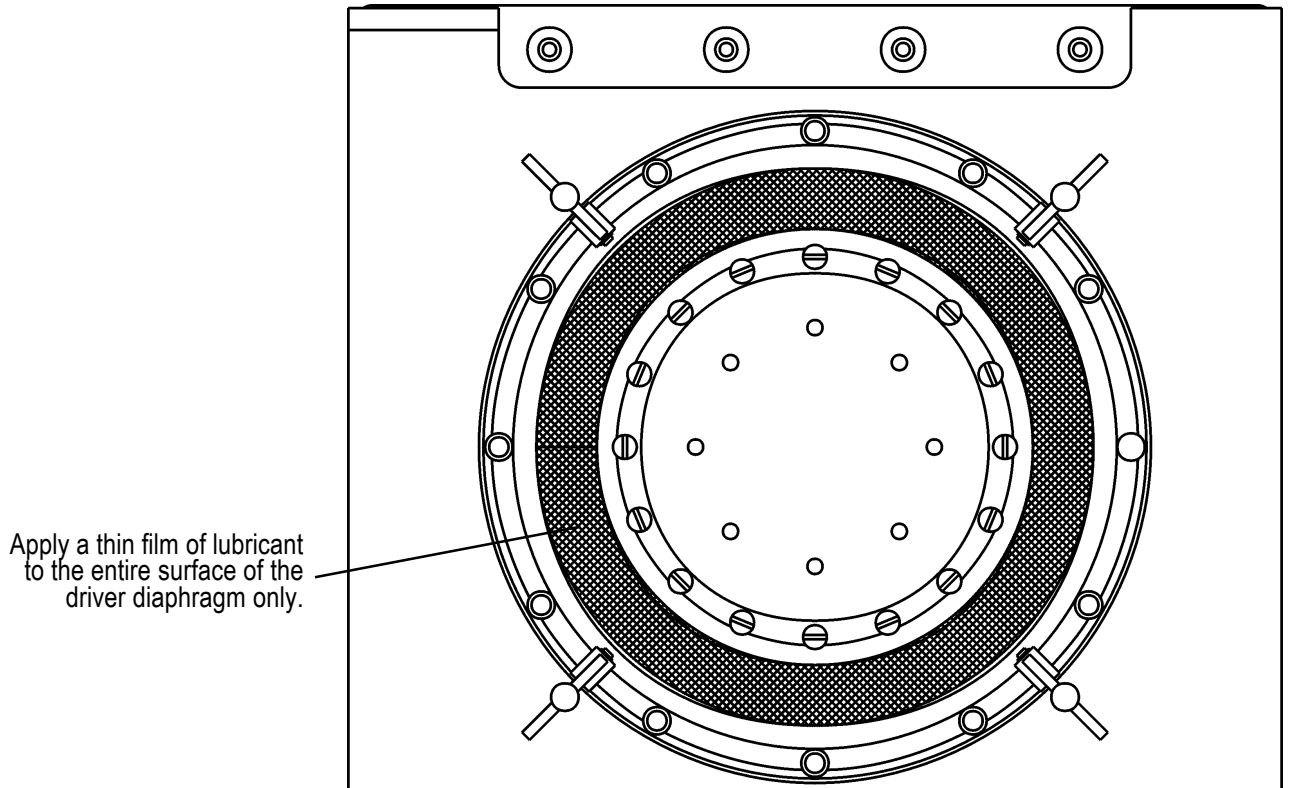

Figure 7.1. Driver Diaphragm Lubrication.

Warning

Only SensorMedics approved lubricants should be used. Use of any other lubricants could result in damage to the Driver Diaphragm or Bellows Water Trap Membrane causing ventilator failure or patient injury.

Precaution

The Driver Diaphragm of the SensorMedics 3100B must be lubricated every 500 hours of use as described in this chapter. Failure to lubricate the Driver Diaphragm may result in premature wear of the diaphragm, which could result in failure of the driver mechanism.

D. Patient Circuit Calibration

D. Patient Circuit Calibration

Before use on a patient, each patient circuit must be calibrated to the Model 3100B by following this procedure:

1. Insert the stopper in the Patient Circuit “Y” and turn on the Bias Flow gas.
2. Set Max P_A Alarm to 59 cmH₂O.
3. Rotate the Mean Pressure ADJUST control to “Max.”
4. Adjust the Bias Flow to 20 LPM.
5. Depress and hold RESET (Oscillator OFF).
6. Observe the Mean Pressure display and adjust the Patient Circuit Calibration screw for a reading of 39–43 cmH₂O.

Precaution

Do not over adjust the Patient Circuit Calibration screw. Over adjustment may cause damage to the device. The screw will reach a mechanical stop when it is at the adjustment limit. **DO NOT FORCE THE SCREW PAST THIS STOP!**

E. Other Scheduled Periodic Calibration

There are two other functions within the Model 3100B HFOV which require periodic calibration:

1. Control Package DC Power Supply.
2. Airway Pressure Monitor Transducer Calibration.

Maintenance of accurate calibration of these functions is extremely important to the proper function of the Model 3100B HFOV. If at any time, a calibration discrepancy exists that cannot be solved by the normal calibration procedures described below, do not attempt to treat a patient with the HFOV. Call SensorMedics immediately for assistance.

The calibration interval for these functions is tracked on the Elapsed Time Meter (24) on the Rear Panel of the Control Package. A calibration must be performed at least every 2,000 hours or when a discrepancy is noticed. An National Bureau of Standards traceable digital voltmeter and a National Institute of Standards and Technology traceable pressure measurement transducer are required for proper calibration of the Power Supply and the Airway Pressure Monitor.

To assure accurate setup, all periodic calibrations must be done with the Model 3100B HFOV at room temperature and prior to extensive operation of the

E. Other Scheduled Periodic Calibration

oscillator. If the oscillator is warm due to previous operation, allow a non-operating cool-down interval of at least one hour before commencing calibration.

Precaution

The cover enclosing the Control Package, Column, or any other portion of the ventilator must not be removed by the user. To avoid electrical shock hazard, please refer all service requiring cover removal to a qualified biomedical equipment service technician.

Control Package DC Power Supply

The calibration procedure for the Control Package DC Power Supply is as follows:

1. Turn off Power to the 3100B HFOV and unplug unit from AC receptacle.
2. Remove the rear column cover.
3. Plug the 3100B HFOV back into receptacle and turn on Power.
4. Refer to Figure 7.2 to locate screwdriver potentiometer settings R9, R57, and R82 for the DC Power Supply. It is located immediately below the oscillator drive electronics.

E. Other Scheduled Periodic Calibration

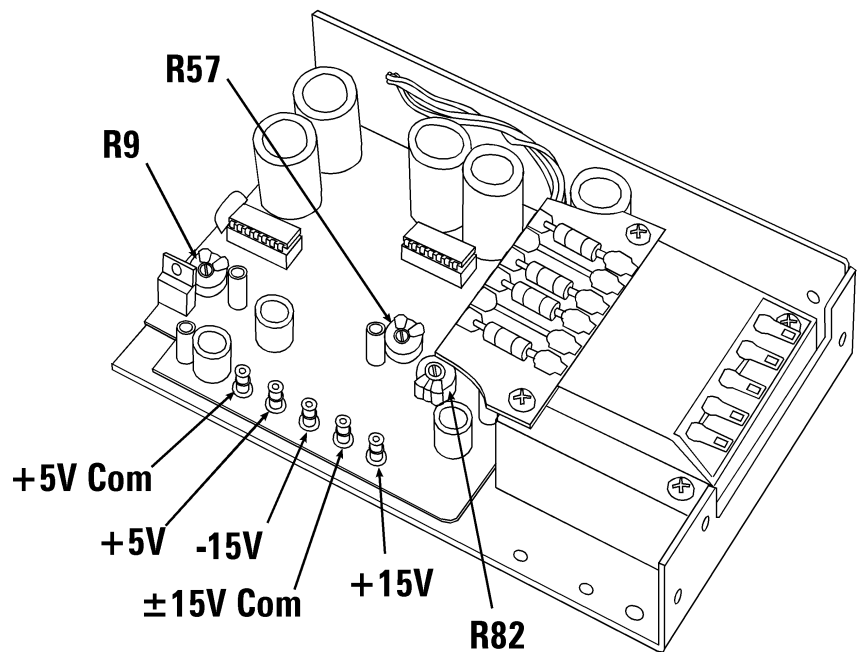

Figure 7.2. Power Supply Adjustment Potentiometers.

5. Connect the negative lead of a digital voltmeter to the +5V Com terminal of the DC Power Supply.
6. Connect the positive lead of the digital voltmeter to the +5V terminal of the DC Power Supply.

⊕ If adjustments are necessary, remove the front column cover.

7. If necessary, adjust R9 for a reading of +5 volts ± 0.25 volts on the digital voltmeter.
8. Connect the negative lead of the voltmeter to the $\pm 15V$ Com terminal.
9. Connect the positive lead of the voltmeter to the -15V terminal.
10. If necessary, adjust R57 for a reading of -15 volts ± 0.75 volts.
11. Connect the positive lead of the voltmeter to the +15V terminal.
12. If necessary, adjust R82 for a reading of +15 volts ± 0.75 volts.
13. When calibration has been completed, replace the column covers.

E. Other Scheduled Periodic Calibration

Airway Pressure Monitor Transducer

The calibration procedure for the Airway Pressure Monitor Transducer is as follows:

1. Locate the pressure transducer ZERO and SPAN screwdriver adjustable controls on the rear panel of the Control Package below the battery compartment (see Figure 4.2). Have a suitably-small screwdriver available to make any necessary adjustments.
2. Attach a digital readout type pressure transducer meter to the bottom “leg” of a 1/8” “T” fitting. Attach one of the “arms” of the “T” fitting directly to the pressure sense fitting of the patient “Y.” Attach the 3100B’s 1/8” Tygon pressure sense tubing directly to the other “arm” of the “T” fitting.
3. Plug the end of the patient circuit “T” with a #1 rubber stopper. Turn on the bias-flow gas pressure, press reset until the P_A comes up, and create a mean pressure of 40–45 cmH₂O (as read on the transducer meter) by using the Mean Pressure and Bias Flow controls (as explained in the Start Up Procedures section of Chapter 6).
4. Remove the #1 stopper and adjust the ZERO control on the rear panel until the Mean Pressure Monitor digital readout matches the pressure transducer meter reading within ± 0.2 cmH₂O. This reading is typically between 0.2 and 0.3 cmH₂O.
5. Replace the #1 stopper, press reset until the P_A comes up, and re-establish the 40–45 cmH₂O mean pressure reading on the transducer meter as explained in Step 3, above.
6. Adjust the rear-panel SPAN control until the Mean Pressure Monitor reading matches the pressure transducer meter within ± 0.2 cmH₂O.
7. If the SPAN control requires no adjustment, the calibration procedure is now complete. But if the SPAN control required readjustment, steps 4, 5, and 6 must be repeated (typically twice) until both the near-zero level and the 40–45 cmH₂O levels match within ± 0.2 cmH₂O.
8. The pressure transducer calibration procedure is now complete. It has been adjusted finer than its “ $\pm 2\%$ of reading or ± 2.0 cmH₂O” specification to allow for minor changes before the next required calibration in 2,000 operating hours.

F. Scheduled Periodic Maintenance

F. Scheduled Periodic Maintenance

There are two other scheduled maintenance intervals suggested by SensorMedics, based on accelerated life testing data and clinical usage history. These are:

1. Every 2,000 operating hours have the Oscillator Subassembly (“Driver”) replaced with a new or rebuilt unit which has new diaphragms and support spiders (the parts subject to flexure fatigue). This replacement must be done by a factory trained technician.
2. Every 8,000 operating hours have the 3100B HFOV returned to a factory authorized service location for a complete overhaul. This overhaul will include the scheduled Oscillator Subassembly replacement plus the replacement of all other parts subject to usage wear and aging (e.g., solenoid valves, regulators, plastic tubing, and cooling fans).

G. Troubleshooting

This section is intended to assist the operator in identifying and correcting any apparent malfunctions of the 3100B System. For assistance, the SensorMedics Technical Support Department can be reached 24 hours a day, 7 days a week.

Special Environmental Considerations

Excessive amounts of dust and lint in the area around the 3100B can cause malfunctions due to blockage of the cooling fan input at the base of the instrument. We recommend keeping the instrument environment as clean and well-ventilated as possible, along with the normal maintenance of the cooling fan filter as described earlier in this chapter.

Electrostatic Discharge

The 3100B is designed and tested to withstand normal to high amounts and occurrences of Electrostatic Discharge (ESD). Under certain circumstances, however, it is still possible for ESD to cause component damage to the 3100B. ESD takes place when a person has built up enough static electricity on their body and clothing that a “shock” occurs when they touch something conductive, like metal or another person. This can damage instrument components if the charge is of sufficient strength. To avoid this, especially during conditions of extremely low humidity when the levels of ESD are generally high, touch the outer metal cabinet of the instrument before touching any other component.

G. Troubleshooting

Electromagnetic Interference

The 3100B is also designed and tested to withstand normal amounts and occurrences of Electromagnetic Interference (EMI). Under certain circumstances, however, it is possible for EMI to effect the components of the system. EMI consists of electromagnetic waves from one electronic device interfering with the function of another electronic device. These waves can be radiated through the air or conducted through electrical wiring. Likely causes of troublesome EMI in the hospital setting include (but are not limited to) MRI systems, lasers, diathermy equipment, cauterizers, transmitting computers, and hand-held radio transmitters.

Operation of radio transmitters (e.g., walkie-talkies, cellular phones, etc.) within 20 feet of the instrument may cause erroneous pressure readings, which can lead to false alarms and automatic shut-down. These erroneous pressure readings are not due to fluctuations in the actual pressure but are the effect of EMI on the components of the measurement circuits. Once the disturbance stops, the reading returns to normal. If the condition of interference is strong enough, and lasts long enough, the $>60\text{cmH}_2\text{O}$ or the $<5\text{ cmH}_2\text{O}$ alarms may be triggered, which will cause the dump valve to open and the oscillator to stop. Once the EMI disturbance has stopped or has been removed, press the reset switch to restart the oscillator. The situation can generally be remedied by locating the offending device and then distancing it at least 20 feet away.

In addition to the *radiated* EMI described above, *conducted* EMI can also cause the same problems by disturbing the AC power line. Typical devices which can exhibit this phenomenon are personal computers and other devices that rely on high speed switching electronics. This sort of interference can be difficult to locate if there are many such devices in the immediate vicinity. Without expensive electronic detection equipment the only means available to locate the offending device is to power down the surrounding systems one at a time until the interference is removed.

It is important to note that *radiated* interference from hand-held radio transmitters is the most common, and sources such as these should be isolated first. The majority of devices used in a hospital environment have been checked for conducted emissions and only through a malfunction of the device is there likely to be an interference problem.

Troubleshooting Chart

The following chart should be used as a guide in correcting problems that may arise in the use of the 3100B. For problems not covered by this list, or for any questions or concerns, call the SensorMedics Technical Support Department.

Precaution

Troubleshooting with the 3100B should be done **“OFF PATIENT”** to avoid any potentially dangerous situations such as abrupt changes in the P_A.

Visual / Audible Alarm Occurring

Condition	Possible Causes	Possible Remedies
Displayed P _A > 60 cmH ₂ O Alarm	Patient at high P _A and spontaneously breathing.	Bias Flow rate possibly insufficient, re-adjust P _A using higher flow. Also, consider clinical status of patient.
	Obstruction in expiratory limb.	Replace patient circuit.
	Obstruction in pressure sense line.	Replace patient circuit.
	Interference from a radio transmitter.	Remove source of interference.
Displayed P _A > Set Max P _A Thumbwheel Alarm	Patient spontaneously breathing.	Bias Flow rate possibly insufficient, re-adjust P _A using higher flow. Also, consider clinical status of patient.
	Improper setting of thumb-wheel switch.	Change setting.
	Obstruction in expiratory limb.	Replace the patient circuit.
	Obstruction in pressure sense line.	Replace the patient circuit.
	Patient circuit temperature rise.	Check and correct circuit temperature.
	Interference from a radio transmitter.	Remove the source of interference.

G. Troubleshooting

Visual / Audible Alarm Occurring (cont.)

Condition	Possible Causes	Possible Remedies
Displayed $P_A < \text{Set Min } P_A$ Thumbwheel Alarm	Patient spontaneously breathing.	Bias Flow rate possibly insufficient, re-adjust P_A using higher flow. Also, consider clinical status of patient.
	Improper setting of thumb-wheel switch.	Change setting.
	Improper setting of P_A adjust or flow meter.	Change setting.
	Patient circuit temperature drop.	Check and correct circuit temperature.
	Leak in patient circuit or humidifier.	Eliminate leak or replace circuit.
	Cap diaphragm leak.	Replace cap diaphragm.
Displayed $P_A < 5 \text{ cmH}_2\text{O}$ Alarm	Interference from a radio transmitter.	Remove source of interference.
	Improper setting of P_A adjust or flow meter.	Change setting.
	Leak in humidifier or patient circuit, including patient disconnect.	Eliminate leak or replace circuit.
	Cap diaphragm leak.	Replace cap diaphragm.
	Interference from a radio transmitter.	Remove source of interference.
Oscillator Stopped with no other alarm occurring	Open Water Trap Stopcock	Close Water Trap Stopcock
	Power setting too low and ΔP is less than or equal to $7 \text{ cm H}_2\text{O}$. Oscillator Failure.	Adjust setting for desired ΔP . Call SensorMedics Service.

Visual / Audible Alarm Occurring (cont.)

Condition	Possible Causes	Possible Remedies
-----------	-----------------	-------------------

G. Troubleshooting

Source Gas Low Alarm	Input pressure less than 30 psi, either from blender or cooling air.	Check input gas lines.
	Input filter needs replacement.	Replace filters.
	Flow restriction in gas supply lines.	Replace supply lines.
	Internal leak.	Call SensorMedics Service.
Battery Low Alarm	Battery voltage less than optimal.	Replace battery.
	Battery disconnected.	Properly reconnect battery.
Oscillator Overheated Alarm	No cooling gas flow.	Assure cooling gas supply hose is attached.
	Oscillator overheated due to poor cooling gas flow.	Check cooling gas flow for blocked filter element or restricted supply hose—replace if necessary.
	Oscillator overheated due to mechanical failure of oscillator subsystem.	Call SensorMedics Service.

Failure During Checkout

Condition	Possible Causes	Possible Remedies
Reset / Power Failure	AC power removed from system or main power interruption.	Check line cord. If okay, check other equipment on same outlet. If other equipment okay, possible internal fault. Contact SensorMedics Service. To start oscillator after correcting problem, apply power to system, press and hold "RESET" to establish P _A , and then press Stop/Start switch.
	Internal power supply failure.	Call SensorMedics Service.

Failure During Checkout (cont.)

Condition	Possible Causes	Possible Remedies
Failure to meet Patient Circuit Calibration	Leak in patient circuit or humidifier connections.	Eliminate leak or replace patient circuit.

G. Troubleshooting

	<p>Improper flow meter setting.</p> <p>Open Water Trap Stopcock</p> <p>Internal leak or maladjustment.</p>	<p>Set flow meter to 20 LPM, sighting on center of ball.</p> <p>Close Water Trap Stopcock</p> <p>Call SensorMedics Service.</p>
<p>Failure of Ventilator Performance Check— P_A out of range (LOW)</p>	<p>Incorrect Patient Circuit Calibration.</p> <p>Center of flow meter ball not used to make 20 LPM adjustment.</p> <p>Incorrect altitude range being used.</p> <p>Internal Failure.</p>	<p>Perform Patient Circuit Calibration.</p> <p>Adjust flow to center of ball.</p> <p>Use appropriate altitude range for your facility.</p> <p>Call SensorMedics Service.</p>
<p>Failure of Ventilator Performance Check— P_A out of range (HIGH)</p>	<p>Incorrect Patient Circuit Calibration.</p> <p>Center of flow meter ball not used to make 20 LPM adjustment.</p> <p>Incorrect altitude range being used.</p> <p>Internal Failure.</p>	<p>Perform Patient Circuit Calibration.</p> <p>Adjust flow to center of ball.</p> <p>Use appropriate altitude range for your facility.</p> <p>Call SensorMedics Service.</p>

Failure During Checkout (cont.)

Condition	Possible Causes	Possible Remedies
<p>Failure of Ventilator Performance Check—</p>	<p>Bias Flow tubing from humidifier to circuit has been cut to less than 30", or tubing not supplied with patient circuit being used.</p>	<p>Use Bias Flow tubing supplied with circuit and do not shorten.</p>

G. Troubleshooting

ΔP out of range (LOW)	Power not set at 6.	Set Power to 6.
	Compression characteristics of humidifier allowing ΔP to drop.	Bypass humidifier for performance check, then re-attach.
	Internal Failure.	Call SensorMedics Service.
Failure of Ventilator Performance Check—ΔP out of range (HIGH)	Oscillator not warmed up.	Allow Oscillator to warm up for 5 minutes.
	Incorrect altitude range being used.	Use appropriate altitude range for your facility.
	Internal Failure.	Call SensorMedics Service.

Unexplained Operation

Condition	Possible Causes	Possible Remedies
Oscillator shuts down and Dump Valve opens during operation	Drastic change in P _A due to over-aggressive control change using the P _A Adjust.	Re-establish P _A and make any small adjustments to P _A using Flow-meter Adjust. Note: see Clinical Guidelines chapter for minimum flow requirements.
	ET Tube has become disconnected.	Reconnect ET Tube.
	Radio Frequency Interference.	Locate and distance offending device.
Oscillator will not restart after temporary disconnection (such as for routine suctioning).	To restart oscillator, P _A must first be >5 cmH ₂ O, but in order to achieve P _A >5 cmH ₂ O, oscillator must be on.	Reduce power and increase P _A to target level using flow meter and P _A Adjust Control—then increase power while keeping P _A on target by adjusting flow meter or P _A control valve down.

Unexplained Operation (cont.)

Condition	Possible Causes	Possible Remedies
P _A unstable—jumps by 2–3 cmH ₂ O	Water collecting at P _A Control Valve.	Adjust circuit height for better draining.
	Patient spontaneously breathing.	Bias Flow rate possibly insufficient; re-

H. Supplies and Replacement Parts

	Worn or defective cap diaphragm. Internal Failure.	adjust P _A using higher flow. Also, consider clinical status of patient. Replace cap diaphragms. Call SensorMedics Service.
Humidifier not operating properly	Excessive heat from driver Room temperature > 84°F	Ensure cooling gas is connected. Try different source connection for cooling gas. Decrease room temperature.
P _A jumping by > 5 cmH ₂ O when trying to adjust with P _A Adjust Valve.	Worn or improperly seated cap diaphragm. Internal Failure.	Replace cap diaphragms. Call SensorMedics Service.
Oscillator making a squeaking sound	Cap diaphragm defective.	Replace cap diaphragm.

H. Supplies and Replacement Parts

Parts and Supplies can be ordered by calling the SensorMedics Customer Service Department. The Customer Service Representative can answer questions concerning correct parts configurations and prices.

Part Number

Description

- 771384-102 3100B Patient Circuit Body (Flex Circuit with Heated Wire–Box of 4)
- 766895 3100A Patient Circuit Body (Box of 4)
- 766896 Cap/Diaphragm Set (Box of 4)
- 766897 Bellows/Watertrap (Box of 4)
- 767163 Gas Filter Cartridge Element (Package of 10)
- 765734-104 Connecting Tube Assembly (8" length, blue)
- 765734-105 Connecting Tube Assembly (8" length, green)

767164
0601G

H. Supplies and Replacement Parts

765734-106	Connecting Tube Assembly (26" length, red)
765734-107	Connecting Tube Assembly (36" length, red, for use with 771384-102 patient circuit)
766595	Humidifier Tubing
766798	Column Lint Filter Element
765742	Hold Down Strap, Patient Circuit
770566	Adjustable Cradle with Collar, Patient Circuit
768965	Mounting Bracket, Humidifier, 77mm (RCI ConchaTherm)
768968	Mounting Bracket, Humidifier, 30mm (Fisher and Paykel)
765298	Lubricant

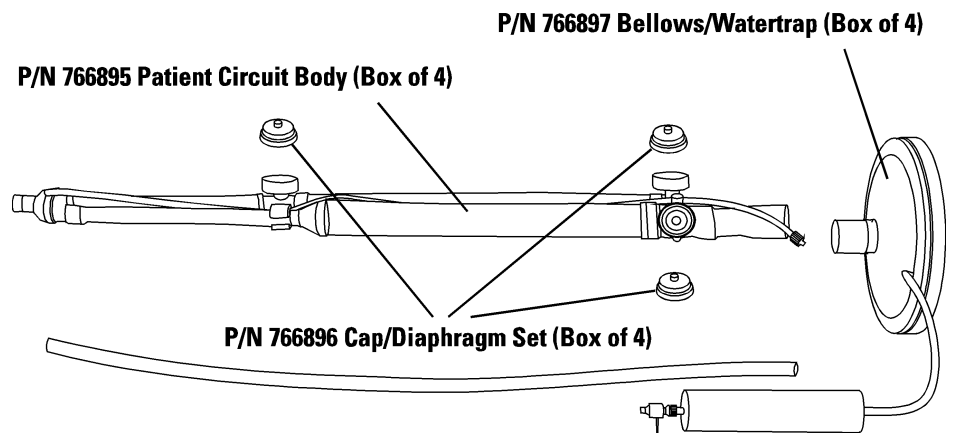

Figure 7.3. Patient Circuit Parts.

A. Treatment Strategies

A. Treatment Strategies

The clinical guidelines described below reflect the strategies and applications developed during the course of the Multicenter Oscillatory ARDS Trial (MOAT II) Prospective Randomized Control Trial.

A recently published trial by the National Institutes of Health ARDS network, comparing a “lung protective” strategy of lower tidal volumes (< 6 ml/kg) and plateau pressures (< 30 cm H₂O) with a higher tidal volume strategy, reported an absolute mortality reduction of 9%. High frequency oscillatory ventilation (HFOV) is an alternative method of ventilation, which theoretically achieves the goals of lung protective ventilation. HFOV achieves gas exchange by applying a constant mean airway pressure, higher than that usually applied during conventional ventilation. Thus, HFOV allows maintenance of alveolar recruitment while potentially avoiding both the cyclic closing and opening of alveolar units as well as the high peak airway pressures that occur with conventional ventilation techniques.

Adjusting the 3100B's Controls to Execute the Treatment Strategies

The strategies are easy to implement because, for most clinical situations, only two of the 3100B's five controls are employed: mean airway pressure and oscillatory pressure amplitude (ΔP). The other three, Bias Flow, Frequency and % Inspiratory Time, are rarely changed during the course of treatment, as explained below.

Bias Flow

A continuous flow of fresh, humidified gas from a standard humidifier and Air/Oxygen blender is a fundamental requirement for replenishing oxygen and removing carbon dioxide from the patient circuit. In most applications the flow rate should be set at not less than 20 l/min. However, the effect of increasing this control is relatively benign unless exceptionally high oscillatory amplitudes are required. In these cases, bias flow should be higher to insure that the patient circuit clearance flow is greater than the patient's oscillatory flow. If the bias flow is inadequate, the patient circuit's effective dead space will increase and diminish the ventilation affect being sought by increasing the oscillatory amplitude (ΔP). Additionally, when operating the ventilator at high oscillatory amplitudes it may be necessary to increase the flow to maintain mean airway pressure. Although changes in Bias Flow will cause changes in P_A , in practice a flow rate of 20–40 l/min is typical.

If signs of carbon dioxide retention persist, increase the bias flow in increments of 5 l/min as frequently as every 15 minutes. Remember that the P_A Adjust

A. Treatment Strategies

control will have to be turned counterclockwise to compensate for the increased flow, and maintain the desired P_A .

Frequency

For adult applications the typical starting frequency is 5Hz. In patients who present with refractory hypercapnia with maximal oscillatory amplitude, the frequency is then decreased incrementally to improve ventilation.

% Inspiratory Time

For most therapeutic situations, 33% has been found to be effective for most patients. This control typically does not change during the course of treatment.

FIO₂

As for the adjustment of inspired oxygen concentration (FIO₂), the basic strategy employed with the 3100B is the same as in conventional ventilator strategy—wean the concentration lower, as tolerated.

Mean Airway Pressure and Oscillatory Pressure Amplitude

Having addressed these seldom-changed controls and the approach to FIO₂ management, it is time to turn attention to the two controls at the heart of the strategy for patient management with the 3100B: mean airway pressure and oscillatory pressure amplitude (ΔP).

Mean and Range of 3100B Settings

The table below summarizes the ranges of control settings employed during the MOAT II Clinical Trial.

Mean and Standard Deviation of 3100B Settings from MOAT II Clinical Trial			
	Mean (Standard Deviation)		
Patient Weight (kg)	78 (25)		
	24 hours	48 hours	72 hours
FiO ₂	0.51 (0.15)	0.52 (0.17)	0.51 (0.15)
Mean P _A (cm H ₂ O)	29 (6)	28 (6)	28 (6)
Frequency (Hz)	4.7 (0.7)	4.7 (0.7)	4.5 (0.9)
Amplitude (cm H ₂ O)	66 (14)	65 (13)	66 (17)

Mean Airway Pressure

Mean airway pressure changes are accomplished by a single-turn control that varies the inflation of a mushroom valve which, in turn, increases the resistance to the exit of the bias flow from the expiratory limb of the patient circuit. The

A. Treatment Strategies

management of mean airway pressure is fundamental to controlling oxygenation. Increases in mean airway pressure increase lung volume and therefore alveolar surface area. At any given level of oscillatory pressure amplitude (ΔP), oxygenation is usually improved by increasing the mean airway pressure, and vice versa. Disease-specific strategies for the manipulation of mean airway pressure will be described below.

P_A will show small fluctuations with temperature and humidity changes. The operator should be ready to make minor adjustments to P_A as the circuit temperature rises and falls as it may, for instance, when a humidifier canister is filled with fresh water.

Oscillatory Pressure Amplitude

Changes in the oscillatory pressure amplitude (ΔP) are accomplished with the ten-turn "Power" control, which adjusts the electrical current level applied to the driving coil of the linear motor that displaces the diaphragm-sealed piston. As the piston is displaced rapidly forward and backward in a nearly square-wave pattern by the square-wave current in the driving coil, high-amplitude pressure fluctuations are symmetrically superimposed on the level of mean airway pressure previously established in the patient circuit as described above (at a %Insp Time of 50%).

Although the 3100B is capable of generating oscillatory pressure higher than 90 cmH₂O peak-to-peak at the proximal endotracheal tube attachment point of the patient-circuit wye, no such pressures are developed in the trachea. This is because the respiratory system impedance (of which the endotracheal tube is the dominant element) greatly attenuates these high frequency pressure waves and at the same time distorts their wave shape into a nearly triangular pattern. For instance, at 3 Hz and a compliance of 19 ml/cmH₂O, the losses are:

95%	5.0 mm ET tube
91%	7.0 mm ET tube
84%	9.0 mm ET tube

Hence, in the clinical setting a larger ET tube will result in greater distal pressure waveforms and a greater reduction in arterial PCO₂.

A. Treatment Strategies

To further clarify this oscillatory pressure amplitude phenomenon, consider the following example. A patient with a compliance of 19 ml/cmH₂O is attached to the 3100B's patient circuit with a 5.0 mm ET tube. The 3100B is operating at 3 Hz, 33% Inspiratory Time, a mean airway pressure of 25 cmH₂O and a ΔP of 90 cmH₂O. Hence, the peak proximal airway pressure has a peak of 70 cmH₂O and a low of minus 20 cmH₂O, while the tracheal airway pressure has a peak of approximately 28 cmH₂O and a low of 22 cmH₂O because of the 95% attenuation caused by this size ET tube at 3 Hz. With the 19 ml/cmH₂O compliance, this distal ΔP of 6 cmH₂O creates a high-frequency tidal volume of 114 ml in a lung held at a nearly-constant, well-inflated level by the 25 cmH₂O mean airway pressure.

At a given mean airway pressure and frequency, the sole mechanism by which ventilation (carbon dioxide removal) is achieved is the high-frequency tidal volume created by the oscillatory pressure swings (ΔP). Hence, as the "Power" control is increased, the piston displacement increases, the ΔP increases, the tidal volume increases, and ventilation increases.

Although the great majority of patients can be ventilated with this straightforward method of adjusting ΔP upwards to counter a high PaCO₂ level, there are some patients who require an even larger ΔP . When this is the case, the strategy is to take advantage of the frequency-dependent nature of the attenuation caused by the ET tube. As the frequency is reduced, the attenuation diminishes and a larger distal ΔP occurs, resulting in an increase in delivered tidal volume. Reducing the frequency in 1 Hz increments—is generally sufficient to control persistently high PaCO₂ levels. In some patients, the frequency may have to be reduced to 3Hz.

Therapeutic Objectives

Assuming that peak alveolar pressure is the causative factor in airway rupture, the principle advantage of HFOV over conventional ventilation is its ability to maintain adequate ventilation and oxygenation at lower peak alveolar pressures. Because ventilation is so readily achieved with relatively low oscillatory pressure

A. Treatment Strategies

amplitudes, patients can be managed at higher mean airway pressures while simultaneously operating at lower peak alveolar pressures than conventional ventilators. This capability serves to improve oxygenation by increasing alveolar recruitment and reinflation of atelectatic lung spaces, and thereby improving ventilation/perfusion matching. Hence, the therapeutic objectives in using the 3100B are to take maximum advantage of these unique characteristics.

General Aspects of Clinical Strategy

The strategy for the MOAT II clinical trial identified an oxygenation goal of a $SpO_2 \geq 88\%$, with maintenance of mean airway pressure until FiO_2 could be reduced to ≤ 0.60 . The target $PaCO_2$ expected was between 40-70 mm Hg, although a higher $PaCO_2$ was tolerated providing the pH was > 7.15 .

Special Considerations

Precaution

Patient size is an important guideline as to lung volume and anatomical dead space, as well as the metabolic demand placed on ventilation. While the maximum displacement of the 3100B is approximately 365 ml, the actual volume delivered to the patient is dependent on power setting, frequency, endotracheal tube size, and patient respiratory system compliance.

The performance charts in Section 2 of this manual can be used as a guide to these relationships, but they may vary somewhat with individual patients and instruments.

Oxygenation

Mean airway pressure (P_A) was set 5 cm H_2O greater than the P_A during conventional ventilation (CMV) immediately prior to transition to HFOV. Target oxygenation parameters were; pulse oximetry (SpO_2) $\geq 88\%$, with fraction of inspired oxygen (FiO_2) ≤ 0.60 . Once the patient was stabilized on HFOV, the FiO_2 was reduced to ≤ 0.60 as long as SpO_2 was $\geq 88\%$.

An open lung strategy was used to optimize oxygenation on HFOV by increasing mean airway pressure. If an $FiO_2 > 0.60$ was required to maintain $SpO_2 \geq 88\%$, the P_A was increased in increments of 2 to 3 cm H_2O every 20 to 30 minutes to a maximum of 45 cm H_2O . As oxygenation improved, the FiO_2 was reduced to maintain $SpO_2 \geq 88\%$. Once $FiO_2 \leq 0.50$, P_A was decreased in

A. Treatment Strategies

1 to 2 cm H₂O decrements at 4 to 6 hour intervals, as long as SpO₂ remained within the target range.

Initial oscillatory amplitude (ΔP) was titrated to chest wall vibration. ΔP was subsequently titrated to achieve a PaCO₂ within the target range of 40 to 70 mm Hg and maintain pH > 7.15. If the pH was < 7.15, the power setting was increased up to a maximum of “10” in order to increase ΔP in increments of 10 cm H₂O. If adequate ventilation could not be achieved at maximum pressure amplitude, the following interventions were used in sequence:

1. Reduce respiratory frequency in 1 Hz steps to a minimum of 3 Hz.
2. Deflate the endotracheal tube cuff followed by restoration of the P_A by adjusting the P_A controls or bias flow (if P_A was already at maximum setting).

Weaning

Patients were weaned from HFOV back to CMV when FiO₂ ≤ 0.50 and P_A was ≤ 24 cm H₂O with SpO₂ ≥ 88%. For transition back to CMV, the conventional ventilator was set in the pressure control mode with peak inspiratory pressure adjusted to achieve a delivered tidal volume of 6 – 10 ml/kg of actual body weight, PEEP 10 cm H₂O, and 1:1 I:E ratio. These settings were designed to achieve a P_A of close to 20 cmH₂O (approximating the P_A on HFOV just prior to changing to CMV).

Summary of MOAT II Clinical Management Strategies

Management Strategy

B. Disease-Specific Variations to General Clinical Strategies

Target SpO ₂ ≥88 Target PaCO ₂ 40-70 mm Hg		
	Initial Setting	Continued Management
P _A	CMV P _A +5 cm H ₂ O	Increase P _A to achieve the oxygenation goal (45 cm H ₂ O maximum)
Amplitude	Visible chest movement	Adjust the amplitude to achieve the PCO ₂ goal.
Frequency	5 Hz	If the amplitude is maximized, decrease the frequency by 1Hz increments until the ventilation goal is reached. If Frequency = 3 Hz, deflate ETT cuff
FiO ₂	As Needed	Maintain P _A until FiO ₂ < 0.60 (SpO ₂ >88%)
Insp. Time %	33%	

Summary of Weaning Strategy from MOAT II Clinical Trial

Weaning from HFOV				
Transition to CMV when: FiO ₂ < .50 and P _A < 24 cmH ₂ O				
	Tidal Volume	I:E Ratio	PEEP	Mode
Initial CMV Settings	6-10 cc/Kg	1:1	10 cmH ₂ O	Pressure Control

B. Disease-Specific Variations to General Clinical Strategies

Homogeneous Lung Disease Without Significant Air Leak

The primary pulmonary diagnoses which are associated with this pattern of lung disease are: pneumonia and acute respiratory distress syndrome.

For these diagnoses, follow the general strategies outlined previously in this chapter.

B. Disease-Specific Variations to General Clinical Strategies

Non-Homogeneous Lung Disease, Air Leak Syndromes, and Airway Disease

The primary diagnoses in this group of illnesses are: pulmonary interstitial emphysema (PIE), and severe recurrent pneumothoraces. The major pathophysiologic processes are: persistent leak of gas from the airways and alveoli into the interstitium of the lung or into the pleural space, and trapping of gas within the lung.

For these diagnoses, also follow the general strategies outlined above, but with the following important changes in emphasis and pressure levels:

1. When FIO_2 is above 0.6, place equal emphasis on weaning mean airway pressure lower, even if it means accepting higher $PaCO_2$ levels and lower PaO_2 levels, in order to further reduce the peak inflation pressure and, thus, the risk of gas trapping and recurrent air leak.
2. Initiate therapy at a lower frequency to provide a longer expiratory time and, thus, further reduce the risk of gas trapping.
3. Following resolution of air leak, revert to general strategies.

C. Adverse Effects

C. Adverse Effects

High frequency ventilation, as with conventional positive pressure ventilation, has inherent risks. These possible adverse effects include: under/over ventilation, under/over humidification, chronic obstructive lung disease, necrotizing tracheal bronchitis (NTB), atelectasis, hypotension, pneumothorax, pneumopericardium, pneumomediastinum, pneumoperitoneum, and pulmonary interstitial emphysema (PIE).

The table below summarizes the adverse events reported during the MOAT II Clinical Trial and demonstrates that within this study there was no increase in the occurrence of the listed adverse effects with HFOV when compared to conventional mechanical ventilation.

Summary of reported adverse events during MOAT II Clinical Trial		
	HFOV	CMV
Number of patients	75	73
Intractable hypotension failure	0%	3%
Oxygenation failure	5%	8%
Respiratory acidosis failure	5%	8%
Air leak developed or worsened	9%	12%
Mucous plugged ET Tube	5%	4%

Precaution

Follow closely the recommendations contained in this Chapter regarding the use of chest radiographs to monitor patient condition. During HFOV, as with all ventilators, the relationship between improvement in lung compliance, inadvertent increases in lung volume, increased pleural pressure, and decreased venous return is a matter of concern, since it may result in decreased cardiac output.

D. Recommended Monitoring Frequency

Precaution

The patient's tcPCO₂ and tcPO₂ or SpO₂ should be monitored continuously to insure that blood gases are at the proper level. It is important that an unrestricted and unobstructed patient airway be maintained during HFOV. To insure a patent airway, always maintain proper suctioning procedures as described in the Suctioning Guidelines Section of Chapter 8, Clinical Guidelines. Since only proximal airway pressure is monitored, no alarm will occur in the event of an obstruction or restriction.

D. Recommended Monitoring Frequency

The recommended minimum frequency for monitoring the key pulmonary status parameters is the following:

Arterial Blood Gases

1. 45–60 minutes after initiation of HFOV therapy to correlate to transcutaneous values
2. Every 2 hours for 8 hours
3. Every 4 hours for 16 hours
4. Every 8–12 hours depending on institution policy during treatment
5. Within 1 hour after major setting change, or as clinically indicated

Non Invasive Gas Monitoring (tcO₂, tcCO₂, and SpO₂)

1. Continuously. This may alert the clinician to subtle changes in the patients ventilatory status that may not be detectable by auscultation or physical exam.

Chest X-Ray

1. Within 4 hours of start of use
2. Every 12 hours next 24 hours
3. Every 24 hours next 5 days
4. Every 48 hours next 8 days
5. Every week thereafter
6. Whenever lung over inflation is suspected

E. Suctioning Guidelines

E. Suctioning Guidelines

The need to suction during HFOV use should be determined based on institution policy and clinical signs, just as with CV. The Multi-Center Studies found no difference in the frequency of suctioning between the HFOV and CV patients. However, some have observed that more frequent suctioning becomes indicated during the treatment of the sickest patients, especially after they have stabilized.

Precaution

Do not use extraneous ventilator circuit attachments (such as a suction port) without a secondary external alarm capable of detecting ventilator disconnection. Due to their inline pressure characteristics such attachments could possibly keep the P_A alarm from detecting an accidental ventilator circuit disconnection.

Disconnection and Reconnection

The correct steps for disconnection and reconnection of the patient are as follows:

1. Press the Alarm Silence. All the audio alarms will be inactive for 45 seconds. Note the settings for P_A and Power setting.
2. Disconnect patient. This should allow the <5 cmH₂O P_A alarm to open the dump valve and stop the oscillator.
3. Perform suctioning using your institution's standard technique.
4. Reconnect patient.
5. Press and hold RESET. Once the P_A rises above 5 cmH₂O, the oscillator will restart. Readjust Power and Mean Pressure until P_A and ΔP are at the levels noted in step 1.

If the oscillator does not restart (or starts and then stops), first turn the power down to a setting between 2 and 3; then, while holding the reset switch, adjust the P_A to the desired level using the flow meter. Next, while monitoring the P_A, turn the power up to achieve the desired amplitude and adjust the flow meter as necessary to maintain the desired P_A.

A — G

A

Adverse Effects, 1
 Adverse Effects, Potential, 98
 Air Cooling Inlet Fitting, 51
 Air Leak Syndromes, 98
 Airway Disease, 98
 Airway Pressure Monitor, 34
 Airway Pressure Monitor Transducer
 Calibration, 80
 Alarm, 15
 Alarm Battery, Power Failure, 50
 Alarm Subsystem, 35
 Alarm, Battery Low, 85
 Alarm, Oscillator Overheated, 85
 Alarm, Pa < 5 cmH₂O, 84
 Alarm, Pa < Set Min Pa Thumbwheel, 84
 Alarm, Pa > 60 cmH₂O, 83
 Alarm, Pa > Set Max Pa Thumbwheel, 83
 Alarm, Source Gas Low, 85
 Alarms, 16
 Arterial blood gases, 95
 Arterial Blood Gases, 99
 Assembly, 56
 atelectasis, 98

B

Battery Attachment Label, 12
 Battery Compartment, 50
 Battery Low Alarm, 85
 Battery Low Indicator, 14, 47
 Battery Specification Label, 12
 Battery, Power Failure Alarm, Changing,
 74
 Bellows Fasteners, 54
 Bias Flow, 90
 Bias Flow Control, 13, 27
 Blender, 61
 Blender, External Air/O₂, 25
 Blender/Cooling Gas Filter Replacement
 Record, 51
 Blender/Cooling Gas Filter Replacement
 Record Label, 9
 blood gases, Arterial, 95
 Blood Gases, Arterial, 99
 Bulkhead Luer Fittings, 55

C

Calibration, Airway Pressure Monitor
 Transducer, 80
 calibration, patient circuit, 66
 Calibration, Patient Circuit, 77
 Calibration, Periodic, Scheduled, 77
 Calibration, Power Supply, 78
 Caution Alarms, 16, 38
 Changing the Compressed-gas Inlet Filter
 Cartridge Elements, 73
 Changing the Patient Circuit, 75
 Changing the Power Failure Alarm
 Battery, 74
 Chest X-Ray, 100
 Children, Large, Adults Special
 Considerations, 94
 circuit breaker, 53
 Circuit, Patient, 28
 Cleaning and Disinfection, Pre-use, 63
 Cleaning the Column Lint Filter, 75
 Cleaning, Exterior, 72
 Clinical Guidelines, 90
 Clinical Strategy, General Aspects, 94
 color-coded tubes, 59
 Column Lint Filter, Cleaning, 75
 Compartment, Battery, 50
 Compressed-gas Inlet Filter Cartridge
 Elements, Changing, 73
 Connections, Gas, 18
 Connections, Location and Function, 40
 Connections, Rear Panel, 61
 connections, tubing, 61
 Contraindications, 1
 Controls, 13
 Controls, Location and Function, 40
 Cradle, Patient Circuit, 54

D

Delta P, 35
 Delta P Control, 43
 Delta P Indicator, 15
 Dimensions, 19
 Disconnection and Reconnection during
 Suctioning, 100

Disease-Specific Variations to General
 Clinical Strategies, 98
 Drain Valve, Water Trap, 54
 Driver Diaphragm, Lubrication, 75
 Driver Lubrication Record Label, 9
 Driver Replacement Record, 51
 Driver Replacement Record Label, 10
 Dump Valve, 30
 Dump Valve Control, 53

E

Effects, Adverse, 1
 Elapsed Time Indicator, 15
 Elapsed Time Meter, 50
 Electrical Power Supply, 36
 Electrical Specifications, 17
 Electromagnetic Interference (EMI), 82
 Electronic Control and Alarm Subsystem,
 35
 Electrostatic Discharge (ESD), 81
 EMI (Electromagnetic Interference), 82
 Emptying the Water Trap, 73
 Environmental and Operational
 Conditions, 19
 Environmental Considerations, 81
 Explanation of Symbols, 6
 Exterior Cleaning, 72

F

Filter Cartridge Elements, Compressed-
 gas Inlet, Changing, 73
 FIO₂, 91
 Flow, Bias, 90
 Forty-five Sec Silence Pushbutton, 48
 Frequency, 91
 Frequency Control, 13, 44
 Frequency Indicator, 15

G

Gas Connections, 18
 General Clinical Strategies, Disease-
 Specific Variations, 98
 Graphs, Performance, 20

H

Hold Down Strap, 55
 Homogeneous Lung Disease, 98
 Humidifier, 61
 Humidifier Tubing, 54
 Humidifier, External, 25
 Humidity, 19
 hypotension, 98

I

Indications for Use, 1
 Indicators, 14
 Indicators, Location and Function, 40
 Inlet Fitting from Blender, 50
 Inspiratory Time Control, 13
 Inspiratory Time, Percent, 91
 Installation, 56
 Interference, Electromagnetic, 82
 Introduction, 1

L

Labels, Exterior, 7
 Leakage Current, 17
 Lint Filter, Column, Cleaning, 75
 Lubrication, Driver Diaphragm, 75

M

Maintenance, 72
 Maintenance Procedures, Operator, 72
 Maintenance, Periodic, Scheduled, 81
 Mean Airway Pressure, 35, 92
 Mean Airway Pressure Indicator, 44
 Mean and Range of 3100A Settings, 96
 Mean Pressure Adjust, 13, 27, 42
 Mean Pressure Limit, 13
 Mean Pressure Monitor, 15
 mechanical relief valves, 39
 Monitoring Frequency, Recommended, 99
 Multi-Center Controlled Trials, 90
 Multi-Center Studies, 100

N

Name Rating Label, 11
 necrotizing tracheal bronchitis (NTB), 98
 Non-Homogeneous Lung Disease, 98

O

Operational and Environmental
 Conditions, 19
 Operational Verification, 64
 Operator Maintenance Procedures, 72
 Oscillator Compartment (Bellows), 53
 Oscillator Enabled Indicator, 14
 Oscillator Overheated Alarm, 85
 Oscillator Overheated Indicator, 14, 48
 Oscillator Stopped Alarm, 38
 Oscillator Stopped Indicator, 14, 48
 Oscillator Subassembly Replacement, 81
 Oscillator Subsystem, 32
 Oscillatory Pressure Amplitude, 92
 Outlet Fitting to Humidifier, 50
 overhaul, complete, scheduled, 81
 Overload Protection, 17
 Oxygenation, Management, 95

P

Pa < 5 cmH₂O Alarm, 84
 P_A < 5 cmH₂O Indicator, 46
 Pa < Set Min Pa Thumbwheel Alarm, 84
 P_A < 20% of, 14
 Pa > 60 cmH₂O Alarm, 83
 P_A > 60 cmH₂O Indicator, 45
 Pa > Set Max Pa Thumbwheel Alarm, 83
 P_A > 50 cmH₂O Indicator, 14
 P_A Control Valve, 29
 P_A Control Valve Control, 53
 P_A Limit Valve Control, 53
 P_A Sense Fitting, 53
 Parts, 88
 Patient Circuit, 28, 52
 patient circuit calibration, 66
 Patient Circuit Calibration, 77
 Patient Circuit Calibration Control, 14, 27, 48
 Patient Circuit Calibration Failure, 86
 Patient Circuit Calibration Procedure Label, 7
 Patient Circuit Cradle, 54
 Patient Circuit, Changing, 75
 Percent Inspiratory Time, 91
 Percent Inspiratory Time Control, 43
 Percent Inspiratory Time Indicator, 15
 Performance Check, Ventilator, 67
 Performance Graphs, 20
 Performance Verification, 70
 Periodic Calibration, Scheduled, 77

Periodic Maintenance, Scheduled, 81
 Pneumatic Connections, 18
 Pneumatic Logic and Control, 27
 pneumomediastinum, 98
 pneumonia, 98
 pneumopericardium, 98
 pneumoperitoneum, 98
 pneumothoraces, severe recurrent, 98
 pneumothorax, 98
 Position Lock Control, 50
 Potentiometers, Power Supply, 79
 Power Control, 13, 43
 Power Failure Alarm, 38
 Power Failure Alarm Battery, 50
 Power Failure Alarm Battery, Changing, 74
 Power Failure Indicator, 14, 46
 Power Indicator, 15
 Power Requirements, 17
 Power Supply, 36
 Power Supply Calibration, 78
 Power Switch, 53
 Precautions, 3
 Pressure Limit Valve, 29
 Pressure Specifications, 15
 Pressure Transducer Span Adjustment, 50
 Pressure Transducer Zero Adjustment, 50
 Pre-use Cleaning and Disinfection, 63
 proximal airway pressure sensing line, 29
 pulmonary interstitial emphysema (PIE), 98

R

Radio Frequency Interference (RFI)
 Warning Label, 11
 radio transmitters, 82
 Rear Panel Connections, 61
 Rear Panel, Control Package, 49
 Reset / Power Failure, 85
 Reset Button, 14
 Reset Pushbutton, 47
 respiratory distress syndrome, 98

S

safety alarms, 30
 Safety Alarms, 16, 37
 Safety and System Features, Description, 25
 Safety Features, 37
 Safety Standards, 17

T – Z

Scheduled Periodic Calibration, 77
Scheduled Periodic Maintenance, 81
Set Max P_A Alarm Thumbwheel, 13
Set Max P_A Control, 44
Set Max P_A Exceeded Indicator, 14
Set Max P_A Thumbwheel, 15
Set Min P_A, 45
Set Min P_A Alarm Thumbwheel, 14
Set Min P_A Exceeded Indicator, 14
Set Min P_A Thumbwheel, 15
Silence Control, 45-Sec, 14
Silence Indicator, 45-SEC, 14
Source Gas Low Alarm, 85
Source Gas Low Indicator, 14, 47
Span Adjustment, Pressure Transducer,
80
Specifications, 13
square-wave driver, 32
Standards, Safety, 17
Start/Stop Control, 13, 44
Start-up Procedures, 64, 65
Strap, Hold Down, 55
Strategies, Treatment, 90
Suctioning Guidelines, 100
Supplies, 88
System and Safety Features, Description,
25

System Column, 52

T

Technical Support Department, 81
Temperature, 19
Therapeutic Intervention and Rationale,
HFOV, Summary, 97
Therapeutic Objectives, 94
thermal cutout circuit, 34
thermal cutout safety system, 39
Treatment Strategies, 90
Troubleshooting, 72, 81
Troubleshooting Chart, 83
tubes, color-coded, 59
tubing connections, 61
Tubing, Humidifier, 54

U

Unpacking the Instrument, 56

V

Ventilation, Management, 94
Ventilator Performance Check, 67
Ventilator Performance Check Failure, 86

Ventilator Performance Checks Label, 8
Verification, Operational, 64

W

Warning Alarms, 16
Warnings, 1
Water Trap, 31, 39, 54
Water Trap Drain Valve, 54
Water Trap, Emptying, 73
Weaning, 95
Wilford Hall Medical Center, 90

X

X-Ray, Chest, 100

Z

Zero Adjustment, Pressure Transducer,
80