

# Operator's Manual

## Vela™ Ventilator Systems

## Revision History

Date	Revision	Pages	Changes
July 2006	A	All	Release

## Warranty

The Vela ventilator systems are warranted to be free from defects in material and workmanship and to meet the published specifications for TWO (2) years or 8,000 hours, whichever occurs first, and the turbine is warranted to be free from defects in material and workmanship for FIVE (5) years or 40,000 hours, whichever occurs first.

The liability of VIASYS Respiratory Care (referred to as the Company) under this warranty is limited to replacing, repairing or issuing credit, at the discretion of the Company, for parts that become defective or fail to meet published specifications during the warranty period; the Company is not liable under this warranty unless (A) the Company is promptly notified in writing by Buyer upon discovery of defects or failure to meet published specifications; (B) the defective unit or part is returned to the Company, transportation charges prepaid by Buyer; (C) the defective unit or part is received by the Company for adjustment no later than four weeks following the last day of the warranty period; and (D) the Company's examination of such unit or part shall disclose, to its satisfaction, that such defects or failures have not been caused by misuse, neglect, improper installation, unauthorized repair, alteration or accident.

Any authorization of the Company for repair or alteration by the Buyer must be in writing to prevent voiding the warranty. In no event shall the Company be liable to the Buyer for loss of profits, loss of use, consequential damage or damages of any kind based upon a claim for breach of warranty, other than the purchase price of any defective product covered hereunder.

The Company warranties as herein and above set forth shall not be enlarged, diminished or affected by, and no obligation or liability shall arise or grow out of the rendering of technical advice or service by the Company or its agents in connection with the Buyer's order of the products furnished hereunder.

## Limitation of Liabilities

This warranty does not cover normal maintenance such as cleaning, adjustment or lubrication and updating of equipment parts. This warranty shall be void and shall not apply if the equipment is used with accessories or parts not manufactured by the Company or authorized for use in writing by the Company or if the equipment is not maintained in accordance with the prescribed schedule of maintenance.

The warranty stated above shall extend for a period of TWO (2) years from the date of shipment or 8,000 hours of use, whichever occurs first, or for the turbine, for a period of FIVE (5) years from date of shipment or 40,000 hours of use, whichever occurs first, with the following exceptions:

1. Components for monitoring of physical variables such as temperature, pressure, or flow are warranted for ninety (90) days from date of receipt.
2. Elastomeric components and other parts or components subject to deterioration, over which the Company has no control, are warranted for sixty (60) days from date of receipt.
3. Internal batteries are warranted for ninety (90) days from the date of receipt.

The foregoing is in lieu of any warranty, expressed or implied, including, without limitation, any warranty of merchantability, except as to title, and can be amended only in writing by a duly authorized representative of the Company.

## Contents

<i>Revision History</i> .....	<i>ii</i>
<i>Warranty</i> .....	<i>iii</i>
<i>Limitation of Liabilities</i> .....	<i>iii</i>
<i>Notices</i> .....	<i>ix</i>
<i>Safety Information</i> .....	<i>xii</i>
<i>Equipment Symbols</i> .....	<i>xvi</i>
<b>Chapter 1 Introduction</b> .....	<b>1</b>
<i>Features</i> .....	<i>1</i>
<i>Vela Model Matrix</i> .....	<i>2</i>
<i>Performance Specifications and Tolerances</i> .....	<i>3</i>
<b>Chapter 2 Unpacking and Setup</b> .....	<b>7</b>
<i>Ventilator Assembly and Physical Setup</i> .....	<i>7</i>
<i>Setting Up the Front of the Ventilator</i> .....	<i>8</i>
<i>Attaching the Patient Circuit</i> .....	<i>10</i>
<i>Attaching a Nebulizer</i> .....	<i>10</i>
<i>Connections and Layout of the Rear of the Ventilator</i> .....	<i>12</i>
<i>Power up</i> .....	<i>15</i>
<i>Extended Functions</i> .....	<i>16</i>
<i>Operational Verification Testing</i> .....	<i>18</i>
<i>Manual Verification Tests:</i> .....	<i>23</i>
<i>Service Set Up</i> .....	<i>24</i>
<b>Chapter 3 Operation</b> .....	<b>27</b>
<i>Membrane Buttons and LEDs</i> .....	<i>27</i>
<i>Patient Setup</i> .....	<i>31</i>
<i>Setting the Ventilation Breath Type and Mode</i> .....	<i>34</i>
<i>Advanced Settings</i> .....	<i>49</i>
<b>Chapter 4 Monitors and Displays</b> .....	<b>55</b>
<i>Graphic Displays</i> .....	<i>55</i>
<i>Digital Displays</i> .....	<i>58</i>

---

Chapter 5 Alarms and Indicators.....	63
<i>Status Indicators</i> .....	63
<i>Alarm Controls</i> .....	65
<i>Alarm Types</i> .....	65
Chapter 6 Maintenance and Cleaning .....	71
<i>Cleaning &amp; Sterilization</i> .....	71
<i>Cleaning</i> .....	71
<i>Sterilization</i> .....	72
<i>Other Accessories</i> .....	72
<i>Recommended Periodic Maintenance</i> .....	73
<i>Operational Verification Tests</i> .....	74
<i>Battery Care</i> .....	74
<i>Fuses</i> .....	76
Appendix A Contact & Ordering Information.....	79
<i>How to Call for Service</i> .....	79
Appendix B Specifications.....	81
<i>Oxygen Supply</i> .....	81
<i>Electrical Supply</i> .....	81
<i>Data Output</i> .....	82
<i>Atmospheric &amp; Environmental Specifications</i> .....	83
<i>Atmospheric &amp; Environmental Specifications</i> .....	83
<i>Physical Dimensions</i> .....	83
Appendix C Low Flow Oxygen Chart .....	85
Glossary.....	87
Index.....	89

## List of Figures

Figure 1.1 Patient Circuit Assembly .....	5
Figure 1.2 Flow Delivery System Schematic.....	6
Figure 2.1 Ventilator Base Showing Thumbscrew .....	8
Figure 2.2 Exhalation Diaphragm in place .....	8
Figure 2.3 Aligning the valve body .....	8
Figure 2.4 Engaging the valve body.....	9
Figure 2.5 Attaching the Flow Sensor .....	9
Figure 2.6 Connecting the Variable Orifice Flow Sensor .....	9
Figure 2.7 Patient Circuit Connections.....	10
Figure 2.8 Attaching nebulizer tubing.....	10
Figure 2.9 Rear Panel Components.....	12
Figure 2.10 Connecting the high pressure O2 hose.....	13
Figure 2.11 Low pressure oxygen tubing connection.....	14
Figure 2.12 Power Switch Positions.....	15
Figure 2.13 Touch the Screens Indicator on the Main Screen .....	16
Figure 2.14 Screen Select screen.....	16
Figure 2.15 Extended Functions Menu .....	16
Figure 2.16 UVT Startup Screen.....	18
Figure 2.17 The UVT Screen with the Main screen in Service mode.....	19
Figure 2.18 Switch control messages .....	20
Figure 2.19 FiO <sub>2</sub> Calibration Screen .....	22
Figure 2.20 Pressure Relief Valve Setting .....	24
Figure 3.1 Vela Membrane panel (International)      Figure 3.2 Vela Membrane Panel (USA).....	27
Figure 3.3 Flow/Volume Loop in Freeze Mode .....	28
Figure 3.4 Patient Select Screen .....	31
Figure 3.5 Setup .....	32
Figure 3.6 Data Dial .....	33
Figure 3.7 Mode Select Screen.....	34
Figure 3.8 Apnea choices in CPAP/PSV mode.....	35
Figure 3.9 Assist Control Ventilation Waveform.....	38
Figure 3.10 SIMV Waveform.....	39
Figure 3.11 CPAP Waveform.....	40
Figure 3.12 APRV / BiPhasic Mode .....	41

---

Figure 3.13 APRV / BIPHASIC Time Sync .....	42
Figure 3.14 PRVC A/C with test breath (1) and step changes (2-4) to achieve target volume .....	44
Figure 3.15 PRVC SIMV with mandatory (1) and assisted (2-4) breaths.....	45
Figure 3.16 The Data Dial.....	46
Figure 3.17 Accessing the advanced settings screen.....	49
Figure 3.18 Advanced settings indicator .....	49
Figure 4.1 Waveform Graphs Displayed on the Main Screen.....	55
Figure 4.2 Screen Selection.....	56
Figure 4.3 Flow/Volume Loop Frozen.....	57
Figure 4.4 Loop Comparison Buttons .....	57
Figure 4.5 Saved Loops Display .....	57
Figure 4.6 Screen Select Box .....	58
Figure 4.7 The Monitor Screen .....	58
Figure 4.8 The Trends Screen .....	60
Figure 5.1 Battery Status LED .....	63
Figure 5.2 Alarm Limits Screen.....	65
Figure 6.1 Remove the power cord guard.....	77
Figure 6.2 Pry out the fuse holder.....	77
Figure 6.3 Fuse holder with metal tabs upward .....	77
Figure C-1. Low Flow Oxygen Chart.....	85

## List of Tables

Table 1.1 Vela Model Matrix .....	2
Table 1.2 Ventilator Parameters & Alarms Ranges/Tolerances .....	3
Table 1.3 Breathing Circuit Characteristics .....	5
Table 2.1 Items shipped with the Standard model Vela Ventilator .....	7
Table 2.2 Extended Functions .....	17
Table 2.3 Parameter values .....	23
Table 3.1 Displayed Modes .....	34
Table 3.2 Primary Breath Controls .....	45
Table 4.1 Waveform Choices .....	55
Table 4.2 Monitored Values Menu Choices .....	59
Table 5.1 Alarm Conditions .....	69
Table 6.1 Mains fuses .....	76



## Notices

### *Copyright Notice*

© 2005 VIASYS Respiratory Care

This work is protected under Title 17 of the U.S. Code and is the sole property of the Company. No part of this document may be copied or otherwise reproduced, or stored in any electronic information retrieval system, except as specifically permitted under U.S. Copyright law, without the prior written consent of the Company.

For more information, contact:

#### **U.S.A.**

VIASYS Respiratory Care Inc.

22745 Savi Ranch Parkway

Yorba Linda, California 92887-4645

Telephone: +1-800-231-2466

+1-714-283-2228

FAX: +1-714-283-8471

Email: [support.vent.us@viasyshc.com](mailto:support.vent.us@viasyshc.com)

#### **EUROPEAN AUTHORIZED REPRESENTATIVE**

VIASYS Healthcare GmbH

Leibnzstrasse 7

97204 Hoechberg

Germany

Telephone: +49-931-4972-0

FAX +49-931-4972-423

[www.viasyshealthcare.com](http://www.viasyshealthcare.com)

### ***Trademark Notices***

Vela is a trademark of VIASYS Respiratory Care in the U.S. and some other countries. All other brand names and product names mentioned in this manual are trademarks, registered trademarks, or trade names of their respective holders.

### ***EMC Notice***

This equipment generates, uses, and can radiate radio frequency energy. If not installed and used in accordance with the instructions in this manual, electromagnetic interference may result. The equipment has been tested and found to comply with the limits set forth in EN60601-1-2 for Medical Products. These limits provide reasonable protection against electromagnetic interference when operated in the intended use environments described in this manual.

The ventilator has been tested to conform to the following specifications:

MIL-STD-461D:1993, MIL-STD-462D:1993, EN55011:1991, IEC 1000-4-2:1994, IEC 1000-4-3:1994, IEC 1000-4-4:1994, IEC 1000-4-5:1994, QUASI-STATIC:1993

This ventilator is also designed and manufactured to comply with the safety requirements of IEC 601-1, IEC 601-2-12 1988, CAN/CSA-C22.2 No. 601.1-M90, and UL 2601-1.

### ***MRI Notice***

This equipment contains electromagnetic components whose operation can be affected by intense electromagnetic fields.

Do not operate the ventilator in a MRI environment or in the vicinity of high-frequency surgical diathermy equipment, defibrillators, or short-wave therapy equipment. Electromagnetic interference could disrupt the operation of the ventilator.

### ***Intended Use Notice***

The Vela Ventilator is intended to provide continuous or intermittent ventilatory support for the care of individuals who require mechanical ventilation. The ventilator is a restricted medical device intended for use by qualified, trained personnel under the direction of a physician. Specifically, the ventilator is applicable for adult and pediatric patients weighing at least 10 kg (22 lbs), who require the following general types of ventilation support, as prescribed by an attending physician:

- Positive pressure ventilation
- Assist/Control, SIMV, or CPAP modes of ventilation

The ventilator is suitable for use in institutional and transport settings. It is not intended for use as an emergency medical transport ventilator or for homecare applications.

### ***Regulatory Notice***

U.S. federal law restricts the sale of this device except by or on order of a physician.

### ***IEC Classification***

**Type of Equipment:** Medical Equipment, Lung Ventilator

- The Vela ventilators are suitable for use in institutional and transport environments.
- Ordinary equipment, not protected against the ingress of liquids.
- Not protected/Not suitable for use in the presence of flammable anesthetic gases.
- Class I/Internally Powered, Type BH

### ***Declaration of Conformity Notice***

This device is manufactured by VIASYS Respiratory Care Inc.

This medical equipment complies with the Medical Device Directive, 93/42/EEC, and the following Technical Standards, to which Conformity is declared:

EN60601-1, EN60601-1-2, ISO 9001, EN 46001

**EU Notified Body:** BSI (Reg. No. 0086)

**Trade name:** Vela



If you have a question regarding the Declaration of Conformity for this product, please contact VIASYS Respiratory Care at the number given in Appendix A.

#### **Manufactured by:**

VIASYS Healthcare, Inc.

1100 Bird Center Drive

Palm Springs, California 92262-8099

## Safety Information

Please review the following safety information prior to operating the ventilator. Attempting to operate the ventilator without fully understanding its features and functions may result in unsafe operating conditions.

Warnings and Cautions which are general to the use of the ventilator under all circumstances are included in this section. Some Warnings and Cautions are also inserted within the manual where they are most meaningful.

Notes are also located throughout the manual to provide additional information related to specific features.

If you have a question regarding the installation, set up, operation, or maintenance of the ventilator, contact Customer Care as shown in Appendix A, Contact & Ordering Information.

### *Terms*

<b>WARNINGS</b>	identify conditions or practices that could result in serious adverse reactions or potential safety hazards.
<b>CAUTIONS</b>	identify conditions or practices that could result in damage to the ventilator or other equipment.
<b>NOTES</b>	identify supplemental information to help you better understand how the ventilator works.

### *Warnings*

Warnings and Cautions appear throughout this manual where they are relevant. The Warnings and Cautions listed here apply generally any time you operate the ventilator.

- To avoid explosion, do not operate the ventilator in the presence of flammable anesthetics or in an atmosphere of explosive gases. Operating the ventilator in flammable or explosive atmospheres may result in fire or explosion. Keep the ventilator away from all sources of ignition when using oxygen.
- On high pressure oxygen cylinders, use only approved reducing or regulating valves marked for oxygen service. Such equipment must be operated strictly in accordance with the manufacturer's directions. A spontaneous and violent ignition may occur if oil, grease or greasy substances come in contact with oxygen under pressure.
- To avoid personal injury and the risk of electric shock, as well as damage to the ventilator, do not operate the ventilator with its covers or panels removed. Refer all servicing to a VIASYS Respiratory Care certified service technician.
- All electromechanical systems are subject to malfunction or failure from both internal and external causes. Although the ventilator has been designed to detect and notify you of various conditions by means of alarms, and to shut down in case of possible unsafe operating conditions, anyone operating the ventilator should be trained to respond with a well-rehearsed procedure to provide emergency ventilation in case the ventilator ceases to operate.
- Care should be taken to ensure that the patient does not disconnect from the patient breathing circuit. Such disconnections could be hazardous to the patient.

- Use the internal FiO<sub>2</sub> analyzer to monitor oxygen concentrations. This is required to ensure the desired fraction of inspired oxygen (FiO<sub>2</sub>) is being delivered to the patient. Consult a physician to determine the desired concentration of inspired oxygen to be delivered.
- Do not attach a one-way check valve to the outlet of the exhalation valve. Doing so may adversely affect the operation of the ventilator and may be harmful to the patient.
- Do not operate the ventilator without setting the alarms. All alarms must be set to ensure safe operation. Ensure that all critical alarms, such as the Low Pressure alarm, have been set.
- Operating an improperly functioning ventilator may be harmful to the patient or operator. If the ventilator does not start up properly, or fails to pass the User Verification Tests, remove it from service and contact your VIASYS Respiratory Care certified service technician.
- Do not operate the ventilator unless you are trained to do so. The ventilator is a restricted medical device intended for use by qualified, trained personnel under the direction of a physician. Operation by untrained personnel may result in unsafe operating conditions.
- Do not operate the ventilator unless qualified personnel are in attendance to promptly respond to alarms, inoperative conditions, or sudden malfunctions. Patients on life-support equipment should be visually monitored at all times. Qualified personnel should be prepared to provide an alternate form of ventilation, if needed.
- Lower air density at higher altitudes affects tidal volume delivery and exhaled tidal volume measurements.
- Delivered percentage oxygen may be higher than set at elevations above 5000 feet.
- Do not ignore the ventilator's audible alarms. Alarms indicate conditions that require your immediate attention.
- Do not try to service or repair an improperly functioning ventilator yourself. Contact your VIASYS Respiratory Care certified service technician for all repairs and service.
- Do not use parts, accessories, or options that have not been authorized for use with the ventilator. Using unauthorized parts, accessories, or options may be harmful to the patient or damage the ventilator.
- Do not connect the ventilator to a patient without first pressure testing the patient breathing circuit. Failing to pressure test the patient breathing circuit may result in injury or inadequate therapy. If using a heated humidifier, be sure to include it in the circuit when pressure testing.
- Check the exhalation valve diaphragm after cleaning it, or once per month, to ensure that it is not worn or damaged. A worn or damaged exhalation valve diaphragm may result in improper patient ventilation. Replace the diaphragm as necessary.
- Check all audible and visual alarms daily to make sure they are operating properly. If an alarm fails to activate, contact your VIASYS Respiratory Care certified service technician.
- Although the system continues to ventilate with a XDCR FAULT alert, the accuracy of the tidal volume, minute volume, and pressure measurements may be reduced. Remove the ventilator from service and contact your VIASYS Respiratory Care certified service technician.
- Always ensure that the high pressure alarm limit is set below the Over Pressure Relief setting. Otherwise, a HIGH PRES alarm may not occur and the patient may be subjected to sustained high pressures.
- Although the system continues to ventilate when a NO CAL DATA alert is present, the accuracy of the volume and pressures may be reduced. The system may generate pressures

and volumes that are inconsistent with the front panel settings. Remove the ventilator from service and contact your VIASYS Respiratory Care certified service technician.

- Disconnect the patient prior to accessing the verification self checks. The ventilator does not deliver gas during these procedures.
- The Vela is designed to ensure that the user and patient are not exposed to excessive leakage current per applicable standards (UL2601 and IEC60601-1). However, this cannot be guaranteed when external devices are attached to the ventilator. In order to reduce the risk of excessive enclosure leakage current from external equipment attached to the printer and video ports, isolation of the protective earth paths must be provided to ensure proper connection. This isolation should ensure that the cable shields are isolated at the peripheral end of the cable.

### *Cautions*

The following cautions apply any time you work with the ventilator.











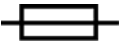
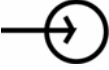

- A protective ground connection by way of the grounding conductor in the power cord is essential for safe operation. Upon loss of protective ground, all conductive parts, including knobs and controls, which may appear to be insulated, can render an electric shock. To avoid electrical shock, plug the power cord into a properly wired receptacle, use only the power cord supplied with the ventilator, and make sure the power cord is in good condition.
- Grounding reliability can only be achieved when the equipment is connected to an equivalent outlet marked 'hospital only' or Hospital Grade.'
- To avoid fire hazard, use only the fuse specified in the ventilator's parts list and is identical in type, voltage rating, and current rating to the existing fuse. Fuses should only be changed by VIASYS Respiratory Care certified service technicians.
- To minimize the potential for electrostatic shock, do not use anti-static or electrically conductive hoses and tubing with the ventilator.
- Run the User Verification Tests prior to clinical application, at least once a month (or as specified by your department guidelines), and any time you suspect the ventilator is not operating properly.
- Do not store the ventilator in hot areas for prolonged periods of time. Temperatures above 27°C (80°F) can shorten battery life. Failing to charge the ventilator while in storage may also shorten battery life.
- When the integrity of the external power earth conductor arrangement is in doubt, operate the ventilator from its internal batteries
- The maximum voltage that can be applied to the Patient Assist Call modular connector is 25 volts rms or 31 VDC.

The following cautions apply when cleaning the ventilator or when sterilizing ventilator accessories.









- Do not clean or dry the ventilator with a high pressure air gun. Applying high pressure air to the ventilator may damage the internal components of the pneumatic circuit and render the ventilator inoperable.
- Do not over clean the ventilator. Repeated use of a cleaning agent can cause residue build-up on critical components. Excessive residue build up can affect ventilator performance.
- Do not sterilize the ventilator. Standard sterilization techniques may damage the ventilator.
- Do not use cleaning agents that contain phenols, ammonium chloride, chloride compounds, or more than 2% glutaraldehyde. These agents may damage the ventilator's plastic components and front panel overlay.
- When cleaning the ventilator:
  - Do not use harsh abrasives.
  - Do not immerse the ventilator in liquid sterilizing agents or liquids of any kind.
  - Do not spray cleaning solution into the exhalation valve or directly onto the front panel.
  - Do not allow cleaning solution to pool on the front panel.
- The flow sensor assembly is a delicate precision assembly. Exercise care when removing, replacing, or cleaning the assembly.
- Do not insert cleaning instruments (such as a cloth, brush, or pipe cleaner) into the flow sensor.
- Do not use a high pressure gas nozzle to dry the flow sensor. High pressure gas may damage the flow sensor.
- Dry the exhalation flow sensor tubes using a low flow gas source (less than 10 L/min) to ensure the differential pressure ports are free of moisture and debris.
- To avoid possible damage to elastomeric components, the peak temperature for accessories should not exceed 131°F (55°C) for gas (ETO) and 275°F (135°C) 15-minute cycle time for steam autoclave.
- Be sure to check with the manufacturer of all chemicals and sterilizing equipment to ensure safe handling procedures are followed.
- It is not necessary to remove the four screws to remove the fan inlet filter. To do so causes mounting hardware to become loose within the ventilator, which may result in electrical damage.

## Equipment Symbols

The following symbols may be referenced on the ventilator or in accompanying documentation.

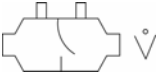
Symbol	Source/Compliance	Meaning
	Symbol #03-02 IEC 60878	Indicates ATTENTION, consult ACCOMPANYING DOCUMENTS
	Symbol #5016 IEC 60417	This symbol indicates a FUSE.
	Symbol #5034 IEC 60417 Symbol #01-36 IEC 60878	This symbol indicates INPUT.
	Symbol #5035 IEC 60417 Symbol #01-37 IEC 60878	This symbol indicates OUTPUT
	Symbol #5019 IEC 60417 Symbol #01-20 IEC 60878	This symbol indicates protective EARTH (ground).
	Symbol #5021 IEC 60417 Symbol # 01-24 IEC 60878	This symbol indicates the EQUIPOTENTIAL connection used to connect various parts of the equipment or of a system to the same potential, not necessarily being the earth (ground) potential (e.g., for local bonding).
	Symbol # 5333 IEC 60417 Symbol #02-03 IEC 60878	This symbol indicates TYPE BH equipment, which indicates equipment that provides a particular degree of protection against electric shock, particularly with regards to allowable leakage current and reliability of the protective earth connection.
	Symbol #5032 IEC 60417 Symbol #01-14 IEC 30878	This symbol indicates the equipment is suitable for alternating current.
	Symbol# 5049 IEC 60417	This Symbol indicates the ON condition for a part of the equipment. When pressed, the ventilator operates from the MAINS voltage (if connected) or internal or external batteries if the battery charge is within operating specifications.
	Symbol #5007 IEC 60417 Symbol #01-01 IEC 60878	Indicates ON (Power)
	Symbol #5008 IEC 60417 Symbol #01-02 IEC 60878	Indicates OFF (Power)
 ACCEPT	Symbol #0651 ISO 7000	Horizontal return with line feed. Indicates ACCEPT entered values for a specific field.
 CANCEL	Graphical Symbol in general use internationally for "DO NOT"	This symbol indicates CANCEL. Do not accept entered values. The ventilator continues to operate at previous settings.
	Symbol #5467 IEC 60417	Pressing the button with this symbol FREEZES the current display.

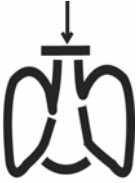

Symbol	Source/Compliance	Meaning
	Symbol #5569 IEC 60417	This symbol indicates a CONTROL LOCK.
	VIASYS Respiratory Care symbol	This symbol represents a NEBULIZER.
	Symbol #5319 IEC 60417	This symbol indicates ALARM SILENCE
	Symbol #5307 IEC 60417	This symbol indicates ALARM RESET
	VIASYS Respiratory Care symbol	Increase OXYGEN
	VIASYS Respiratory Care symbol	Indicates VARIABLE ORIFICE FLOW SENSOR
	Symbol #5031 IEC 60417	This symbol indicates DIRECT CURRENT (DC)
	Symbol #5546 IEC 60417	This symbol indicates the INTERNAL BATTERY STATUS display
	VIASYS Respiratory Care symbol	This symbol indicates INSPIRATORY HOLD
	VIASYS Respiratory Care symbol	This symbol indicates EXPIRATORY HOLD
	VIASYS Respiratory Care symbol	This symbol indicates MANUAL BREATH

This page intentionally left blank.

# Chapter 1 Introduction

The Vela ventilator system is an easy to use, self-contained, servo-controlled, software-driven ventilator. It has a dynamic range of breathing gas delivery that provides for pediatric through adult patients. Its revolutionary user interface provides maximum flexibility with simple operator interaction. It has a flat panel color LCD with real time graphics display and digital monitoring capabilities, a touch screen for easy interaction, membrane buttons and a dial for changing settings. A precision gas delivery turbine with servo controlled active inhalation and exhalation improves performance over previous generations of ventilators.

The Vela may be configured as a conventional ventilator or non-invasive positive pressure ventilator (NPPV). It has been designed to function using most commonly available accessories; there are no proprietary circuits required for your Vela. It is easy to clean and its design does not allow liquids to pool on its surfaces, reducing the likelihood of fluid leakage into the body of the ventilator.

The three models of the Vela come with a wide range of features for the critical care environment. Optional features can be added at the time of purchase or at a later date.

## Features

Packaged in a compact, lightweight unit, the Vela Ventilator provides extensive features:

- Compressor free technology, allowing uninterrupted ventilation.
- A broad range of operating modes including Assist/Control, SIMV, and CPAP.
- Volume Control, PRVC, APRV Bi-Phasic, Pressure Control, and Pressure Support Ventilation.
- Apnea Backup ventilation in SIMV and CPAP/PSV.
- Revolutionary user interface for easy operation and extensive monitoring capabilities.
- All models have integrated graphics. Comprehensive model includes Loops and Trends.
- Communication package including a remote nurse call connection, fiber-optic connection, printer connection and video output port.
- The Vela has both high pressure oxygen inlet with blender and low flow oxygen inlet with accumulator.
- The Vela delivers and displays tidal volumes as BTPS (Body Temperature Pressure Saturated) corrected.
- Self-testing at power-up and background testing during normal operation.
- Internal battery with up to six-hour life.
- Easily understandable User's Guide for quick reference.

For ordering information of option upgrade packages, see Appendix A or contact your VIASYS Respiratory Care products representative.

## Vela Model Matrix

Table 1.1 Vela Model Matrix

OPTION	Vela	Vela +	Vela Comprehensive
% O <sub>2</sub>	X	X	X
100% O <sub>2</sub>	X	X	X
FiO <sub>2</sub> monitor	X	X	X
Nebulizer	X	X	X
Inspiratory Hold	X	X	X
Expiratory Hold	X	X	X
Assist/Control	X	X	X
SIMV	X	X	X
CPAP	X	X	X
Pressure Control	X	X	X
Pressure Support	X	X	X
Basic Waveform Graphics	X	X	X
PRVC/Vsync		X*	X
NPPV		X	X
Leak Compensation		X	X
Loops			X
Trends			X
MIP/NIF			X
Square Waveform			X
APRV/BiPhasic			X
Assured Volume			X

\* Not available outside of the U.S.A. and Canada.

## Performance Specifications and Tolerances

**Table 1.2 Ventilator Parameters & Alarms Ranges/Tolerances**

PARAMETERS	RANGES	TOLERANCES
<b>Controls</b>		
Tidal Volume	50-2000 ml	Greater of: $\pm 10$ ml or 10%
Tidal Volume in PRVC (Plus & Comp Only)	50-2000 ml	Greater of: $\pm 20$ ml or 10%
Breath Rate	2-80 bpm	Lesser of: $\pm 1$ breath or 10% of breath period
Peak Flow	10-140 L/min	Greater of: $\pm 2$ L/min or 10%
<i>Maximum Flow</i>	180 L/min	
PEEP/CPAP	0-35 cmH <sub>2</sub> O	Greater of: $\pm 2$ cmH <sub>2</sub> O or 10%
Pressure Support	OFF, 1-60 cmH <sub>2</sub> O	Greater of: $\pm 2$ cmH <sub>2</sub> O or 8%
Oxygen Percent	21-100%	$\pm 3$ % from 21 – 50% $\pm 5$ % from 51 – 100%
Bias Flow	10-20 L/min	$\pm 1$ L/min
Sigh 1.5 X V <sub>t</sub> (Set)	ON/OFF, 1 Sigh every 100 breaths or 7 minutes, whichever occurs first	$\pm 1$ breath period
Manual Breath	X 1	N/A
Inspiratory Hold	6 second max.	$\pm 0.05$ sec
100% O <sub>2</sub> 3min.	ON/OFF, 3 minute max.	+ 0 %; - 5 %
Over Pressure Relief	20-130 cmH <sub>2</sub> O	$\pm 10$ cmH <sub>2</sub> O
Inspiratory Pause	OFF, 0.1 – 2.0 sec	+ 0.05 seconds
Square Waveform (Comp only)	ON/OFF	N/A
Expiratory Hold	6 second max.	Greater of: $\pm 2$ cmH <sub>2</sub> O or 10%
MIP/NIF (Comp only)	30 second max.	Greater of: $\pm 2$ cmH <sub>2</sub> O or 5%
Inspiratory Pressure	1-100 cmH <sub>2</sub> O	Greater of: $\pm 2$ cmH <sub>2</sub> O or 8%
Inspiratory Time	0.3 – 10.0 sec.	$\pm 0.05$ seconds
Trigger Sensitivity	1 to 20 L/min	$\pm 0.5$ L/min at a setting of 1 L/min; $\pm 1$ L/min at a setting of 2-20 L/min
APRV Biphasic <i>Time High</i> (Comp only)	0.3 – 30 sec.	$\pm 0.05$ seconds
APRV Biphasic <i>Time Low</i> (Comp only)	0.3 – 30 sec.	$\pm 0.05$ seconds
APRV Biphasic <i>Pressure High</i> (Comp only)	0 – 60 cmH <sub>2</sub> O	Greater of: $\pm 2$ cmH <sub>2</sub> O or 10%
APRV Biphasic <i>Pressure Low</i> (Comp only)	0 – 45 cmH <sub>2</sub> O	Greater of: $\pm 2$ cmH <sub>2</sub> O or 10%
NPPV Pressure Control (Plus & Comp Only)	1 – 40 cmH <sub>2</sub> O	Greater of: $\pm 2$ cmH <sub>2</sub> O or 8%
NPPV Pressure Support (Plus & Comp Only)	OFF, 1 – 40 cmH <sub>2</sub> O	Greater of: $\pm 2$ cmH <sub>2</sub> O or 8%
Assured Volume (Comp only)	OFF, 50 – 2,000 ml	Greater of: $\pm 10$ ml or 10%
Volume Limit	50 – 2,500 ml	Greater of: $\pm 10$ ml or 10%

**Table 1.2 Ventilator Parameters & Alarms Ranges/Tolerances (cont)**

PARAMETERS	RANGES	TOLERANCES
<b>Alarms</b>		
High Pressure Alarm Limit	5-120 cmH <sub>2</sub> O	Setting of 5-20 cmH <sub>2</sub> O: ± 2 cmH <sub>2</sub> O Setting of 21-120 cmH <sub>2</sub> O: ± 4 cmH <sub>2</sub> O
Low Pressure Alarm Limit	OFF, 2-60 cmH <sub>2</sub> O	Setting of 2-20 cmH <sub>2</sub> O : ± 2 cmH <sub>2</sub> O Setting of 21-60 cmH <sub>2</sub> O: ± 4 cmH <sub>2</sub> O
Low Minute Volume Alarm	OFF-0.1-99.9 L	Greater of: ± 10% or 20 ml
High Breath Rate	OFF, 3-150 bpm	Greater of: ± 1 bpm or 5% of breath period
Apnea Interval	10-60 sec.	± 0.5 sec
Backup Breath Rate	Greater of: 12 bpm or set breath rate	Greater of: ± 1 breath of 10% of Breath period
Low Regulated O <sub>2</sub> Pressure	35 psig (2.62 bar)	± 2 psig (0.14 bar)
High Regulated O <sub>2</sub> Pressure	65 psig (6.00 bar)	± 2 psig (0.14 bar)
Alarm Silence	60 sec. max.	± 1 second
Alarm Volume	65 - 85 dba at 1 meter	± 5 dBa
<b>Monitors:</b>		
Total Breath Rate ( <i>f</i> )	0-250 bpm	Greater of: ± 1 bpm or 5% of breath period
Spontaneous Breath Rate ( <i>f</i> )	0-250 bpm	Greater of: ± 1 bpm or 5% of breath period
I:E Ratio (I:E)	1.99 - 99:1	Greater of: ± 50 ms or 5%
Exhaled Minute Volume ( <i>V<sub>e</sub></i> )	0-99.9 L	Greater of: ± 10% or the measured breath rate x 10 ml
Spontaneous Exhaled Minute Volume Spon ( <i>V<sub>e</sub></i> )	0-99.9 L	Greater of: ± 10% or the measured breath rate x 10 ml
Mandatory Exhaled Minute Volume (Mand <i>V<sub>e</sub></i> )	0-99.9 L	Greater of: ± 10% or the measured breath rate x 10 ml
Peak Inspiratory Pressure ( <i>P<sub>peak</sub></i> )	0-140 cmH <sub>2</sub> O	Greater of: ± 2 cmH <sub>2</sub> O or 5%
Mean Airway Pressure ( <i>P<sub>mean</sub></i> )	0-99 cmH <sub>2</sub> O	Greater of: ± 2 cmH <sub>2</sub> O or 10%
Inspiratory Time ( <i>T<sub>i</sub></i> )	0.01 – 99.99 sec.	± 0.05 seconds
Expiratory Time ( <i>T<sub>e</sub></i> )	0.01 – 99.99 sec.	± 0.05 seconds
Positive End Expiratory Pressure (PEEP)	0-99 cmH <sub>2</sub> O	Greater of: ± 2 cmH <sub>2</sub> O or 10%
Mandatory Exhaled Tidal Volume (Mand <i>V<sub>t</sub></i> )	0-4,000 ml	Greater of: ± 10% or 10ml
Spontaneous Exhaled Tidal Volume (Spon <i>V<sub>t</sub></i> )	0-4,000 ml	Greater of: ± 10% or 10ml
Inspired Tidal Volume ( <i>V<sub>t<sub>i</sub></sub></i> )	0-4,000 ml	Greater of: ± 10% or 10ml
Oxygen regulated pressure	0 to 100 psig ( 0 to 6.89 bar)	Greater of: ± 10% or 3 psig (0.21 bar)
Percent Oxygen	18 % to 100 %	± 2 %

**Note**

*Specifications apply to Vela models that support the mode or feature described.*

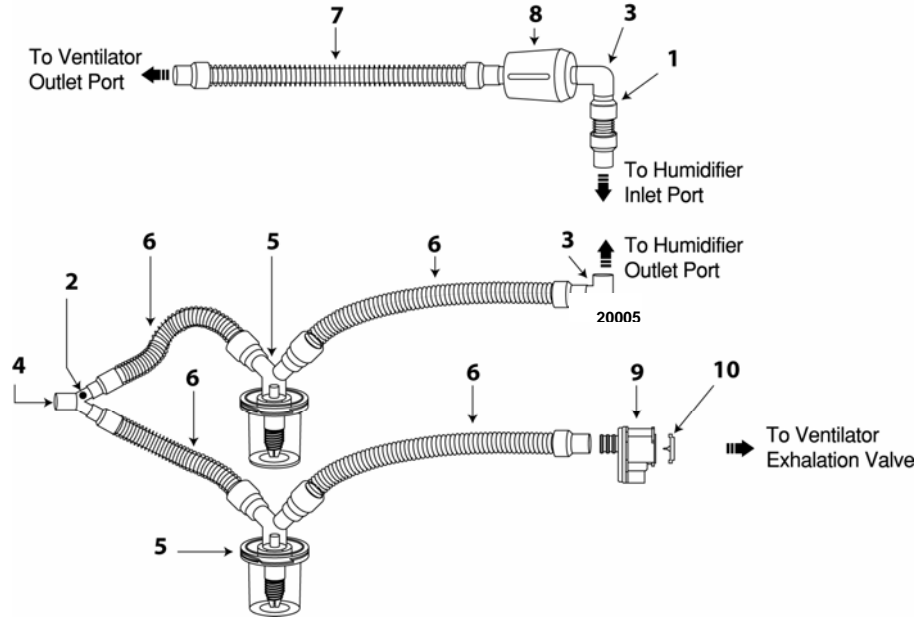

Item No.	Description	Quantity	Adult, # 10684	Ped, # 11226
<u>1</u>	22mm I.D. Cuff Adapter	1	00423	00423
<u>2</u>	Tapered Plug, 7.5mm Male	1	04124	04124
<u>3</u>	90 Degree Elbow Adapter	2	04709	04709
<u>4</u>	Wye Connector	1	20225	20225
<u>5</u>	Water Trap, Natural, Autoclavable	2	09413	09413
<u>6</u>	Circuit Tubing, 30" (76.2 cm) Smooth Bore	4	09531	33546
<u>7</u>	Circuit Tubing, 18" (45.7 cm) Smooth Bore	1	09532	33545
<u>8</u>	Main Flow Bacteria Filter, 0.3 microns	1	09534	09534
<u>9</u>	Exhalation Valve Body	1	20005	20005
<u>10</u>	Exhalation Valve Diaphragm	1	16240	16240

Figure 1.1 Patient Circuit Assembly

Table 1.3 Breathing Circuit Characteristics

Breathing Circuit Characteristics:		
	Adult	Pediatric
Inspiratory Resistance, cmH <sub>2</sub> O /L/min	0.27 @ 60 L/min	0.29 @ 30 L/min
Expiratory Resistance, cmH <sub>2</sub> O /L/min	0.06 @ 60 L/min	0.06 @ 30 L/min
Compliance, ml/ cmH <sub>2</sub> O	1.81	1.35
Internal Volume, ml	1,843	1,374

## Note

All testing and calculations were based on BTPD (Body Temperature Pressure Dry) conditions. The operator is advised, that when adding accessories or components to the patient circuit, to ensure that the inspiratory and expiratory resistance of the resulting breathing system does not exceed 0.6 kPa (6 cmH<sub>2</sub>O) @ 60 L/min for adults and 30 L/min for pediatric patients.

## Schematic

The schematic in Figure 1.2 shows the flow delivery system of the ventilator.

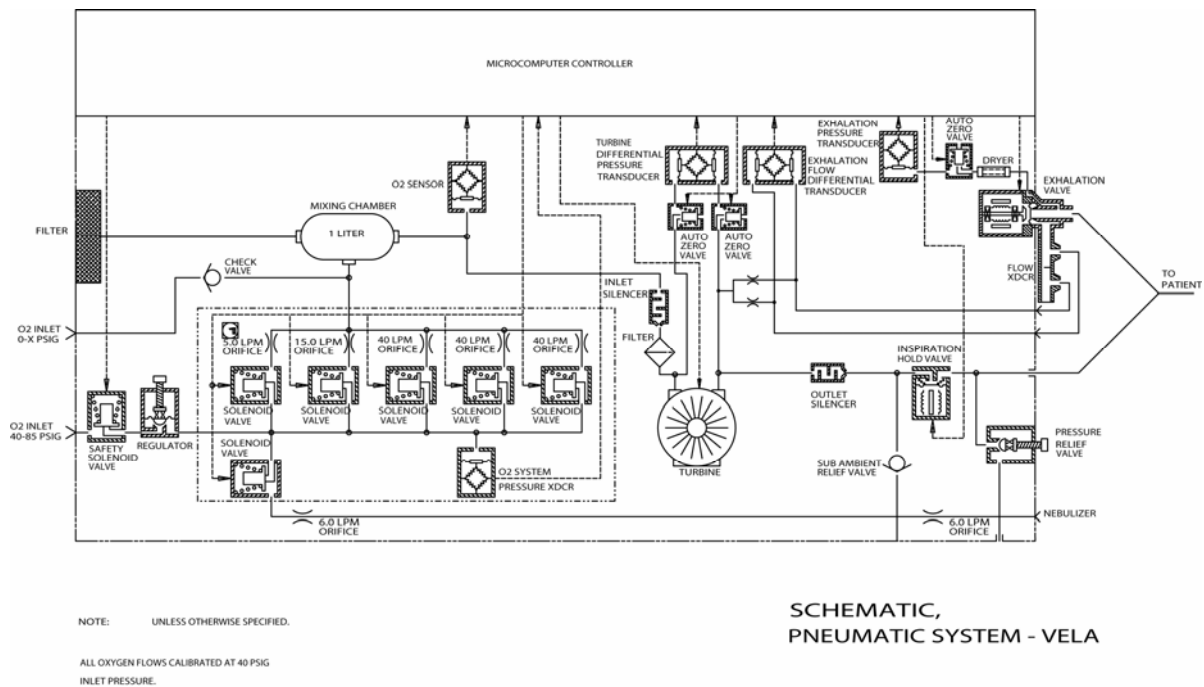

**Figure 1.2 Flow Delivery System Schematic**



# Chapter 2 Unpacking and Setup

## Ventilator Assembly and Physical Setup

### *Unpacking the Ventilator*

The Vela is designed for simplicity of operation and set-up. It requires minimal assembly. You should receive the following items with your ventilator. If you do not receive these items or something is missing or damaged, please contact VIASYS Respiratory Care customer service as shown in Appendix A.

**Table 2.1 Items shipped with the Standard model Vela Ventilator**

Part Number	Description	Quantity
16240	Exhalation Valve Diaphragm	2
Various	15' (3m) high pressure oxygen hose (Country specific)	1
20005	Exhalation Valve Body	2
16496	Variable Orifice Flow Sensor	2
Various	Users Guide (See Appendix A for specific language)	1
Various	Operator's Manual (See Appendix A for specific language)	1
L2864	Op Manual on CD	1

### *Items Required for Ventilator Setup*

You need the following to set up your Vela ventilator:

- **Power Source.** The ventilator operates from a standard 100, 110, 220, or 240 VAC power source, the internal battery or qualified DC Inverter. The factory equipped internal battery is capable of providing power during short-term patient transports or AC power interruptions. The optional extended internal battery can be used for longer term support.
- **Pressurized Oxygen.** The oxygen source must provide clean, dry, medical grade oxygen at a line pressure of 40 to 85 psig (2.8 to 6.0 bar).
- **Low Flow Oxygen.** The low flow oxygen source must provide clean, medical grade oxygen not to exceed 80 L/min at 0.5 psig (.035 bar).

#### Pressurized Oxygen Supply

Pressure Range:	40 to 85 psig (2.8 to 6.0 bar)	(Supply Oxygen)
Temperature:	10 to 40 °C (50 to 104 °F)	
Humidity:	Dew Point of gas should be 1.7° C (3° F) below the ambient temperature (minimum)	
Minimum Flow:	80 L/min at 20 psig (1.4 bar)	
Inlet Fitting:	CGA DISS-type body, No. 1240	

## Assembling the Ventilator

If you ordered one of the stands for the Vela, use the assembly instructions included in the packaging. The ventilator body is easily attached to the base by means of two thumbscrews as shown in figure 2.1.

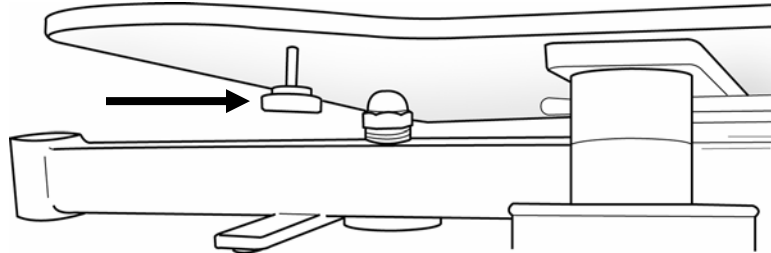

Figure 2.1 Ventilator Base Showing Thumbscrew

## Setting Up the Front of the Ventilator

### Attaching the Exhalation Diaphragm and Valve Body

Carefully seat the rim of the diaphragm on the exhalation valve and gently press around the rim to insure it is seated evenly as shown.

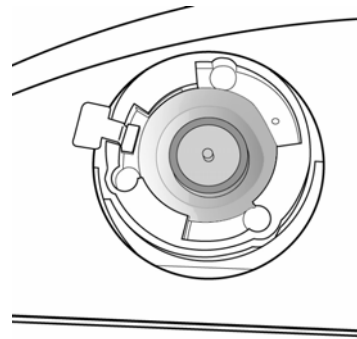
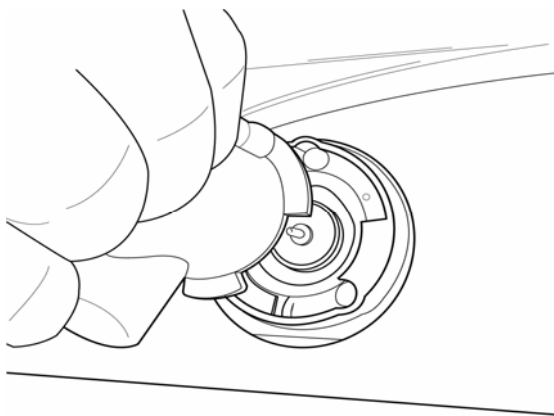

Figure 2.2 Exhalation Diaphragm in place



Line up the fins of the Exhalation Valve Body with the openings in the exhalation valve housing.

Figure 2.3 Aligning the valve body

Press gently in and rotate clockwise until you hear a click.

The locking tab for the exhalation valve body should be firmly in place and the valve body should not swivel.

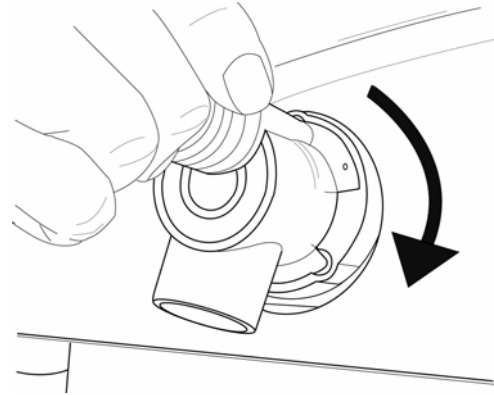

Figure 2.4 Engaging the valve body

### *Attaching the Variable Orifice Flow Sensor*

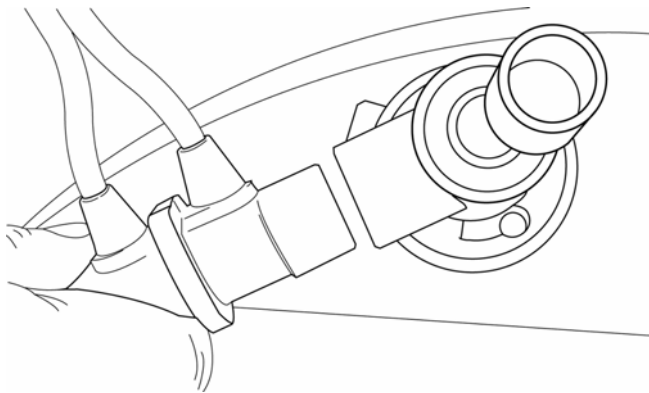
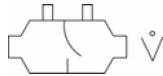

Figure 2.5 Attaching the Flow Sensor

The flow sensor is attached to the valve body as shown in figure 2.5. Gently push the flow sensor into the valve body port until it seats. Do not force it further in as this may damage the sensor or the valve body.

The Variable Orifice sensor connects to the receptacle on the front of the ventilator marked with the icon shown here.



This is a locking connector. To connect, first pull back the plastic locking shroud then push firmly into the ventilator receptacle. Slide the locking shroud back into place when connection is made.

To disconnect, first retract the plastic shroud then firmly pull the connector away from the ventilator. Do not pull up or down as this can damage the connector.

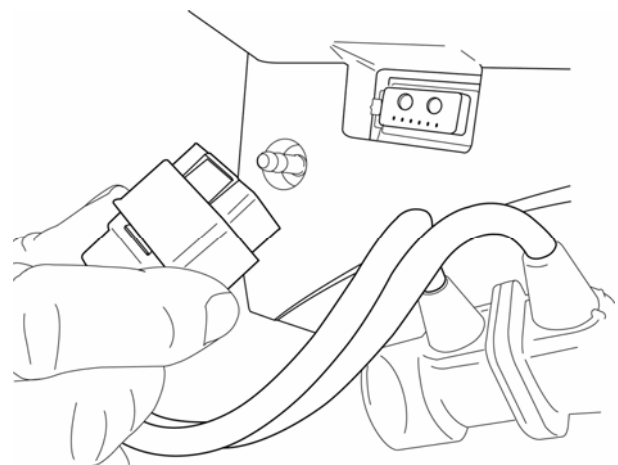

Figure 2.6 Connecting the Variable Orifice Flow Sensor

**CAUTION**

Fully retract the plastic connector shroud before attaching these connectors. Failure to do this can result in damage to the connector.

## Attaching the Patient Circuit

The patient circuit connections are shown in figure 2.7. The inspiratory limb of the patient circuit connects directly to the gas output of the ventilator. An active humidification system or passive Heat and Moisture Exchanger (HME) if prescribed, should be placed in-line in the patient circuit per the manufacturer's instructions.

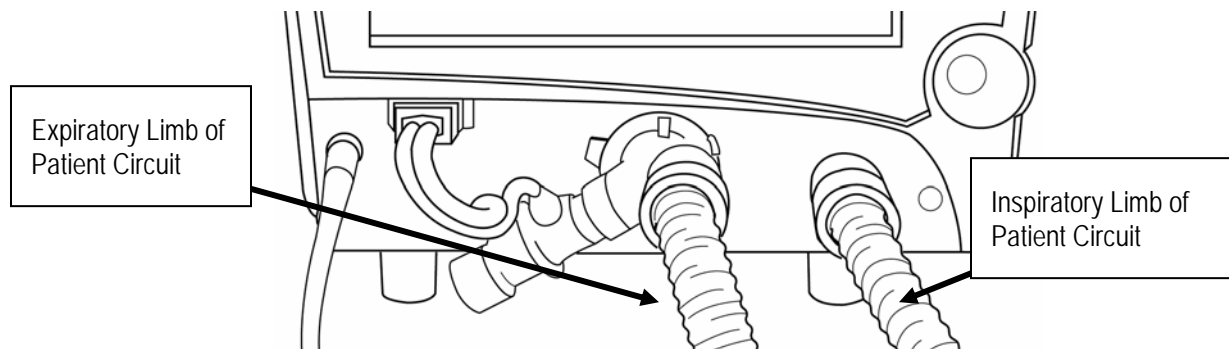

Figure 2.7 Patient Circuit Connections

## Attaching a Nebulizer

You can use an in-line nebulizer with the Vela ventilator (see Chapter 3, Operation). To use a nebulizer you must have a high-pressure oxygen source attached to the ventilator. Attach the nebulizer tubing as shown in figure 2.8.

The fitting is marked with the icon shown here.

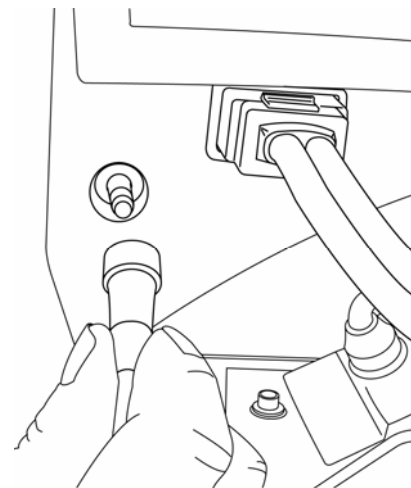

Figure 2.8 Attaching nebulizer tubing

**CAUTION**

Powering the nebulizer from an external flow meter is not recommended.

**CAUTION**

Using a Nebulizer may impact the volumes delivered to the patient

### *Synchronized Nebulizer*

The standard in-line nebulizer is powered by 100% oxygen for delivery of prescribed medications in the ventilator circuit. When nebulization is active, the nebulizer flow is synchronized with the inspiratory phase of each breath and can be adjusted in increments of 1 minute for a maximum of 60 minutes. You may end the nebulization period early by pushing the Nebulizer button again.

---

**Note:**

*See Chapter 3, Operation (section G) for important details concerning operation and safety when using the nebulizer feature.*

---

## Connections and Layout of the Rear of the Ventilator

The oxygen connections, the remote nurse call connection and communication connections are located on the rear panel of the ventilator. The power cable and the power ON/OFF switch are also on the rear panel.

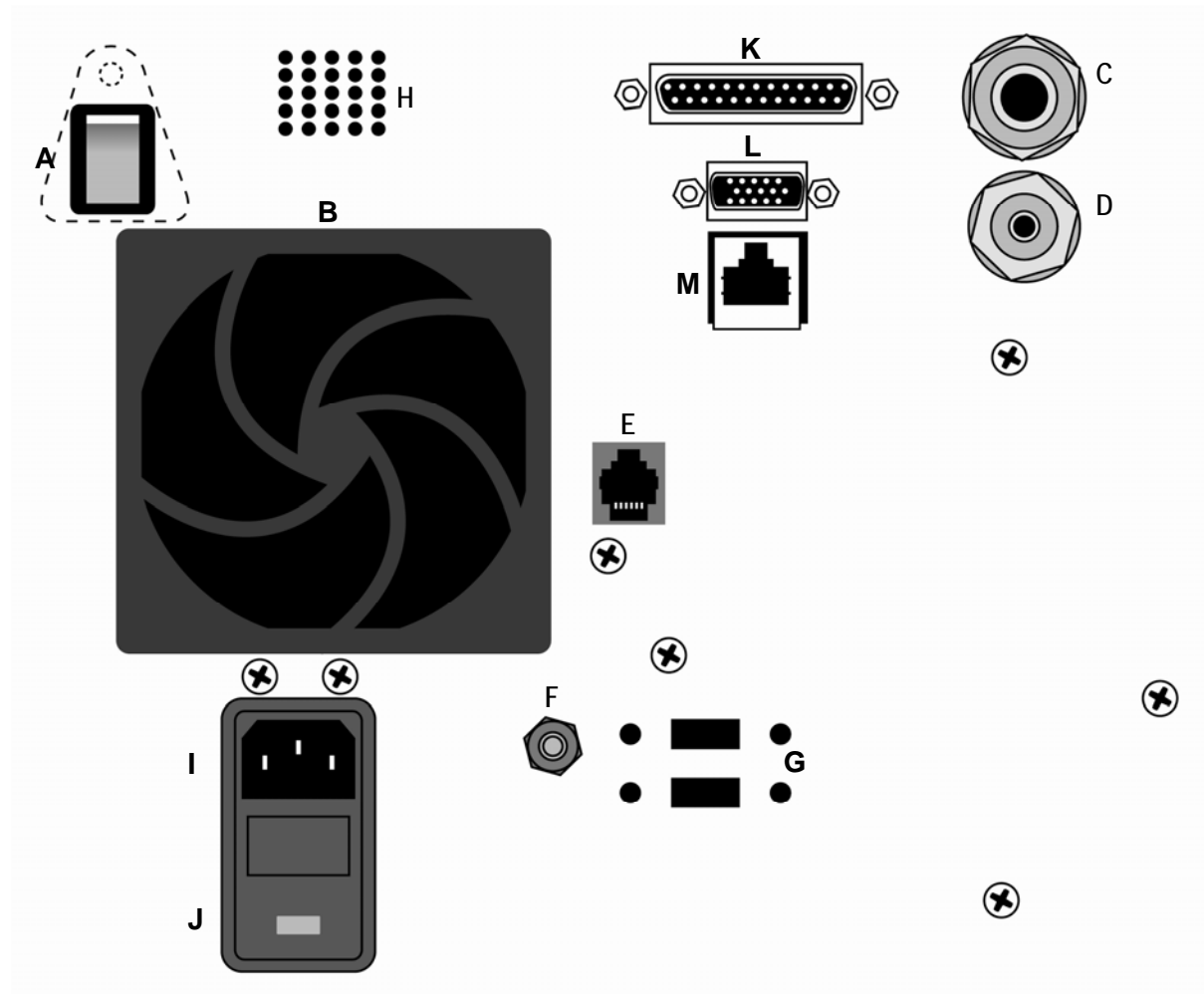

A – Power switch	B – Fan and fan filter
C – High-pressure oxygen fitting	D – Low-pressure oxygen fitting
E – Nurse call system connection	F – Ground terminal
G – Future options	H – Alarm speaker
I – Power cord	J – Fuses
K – Parallel printer port	L – Video output port
M – MIB port	NA

Figure 2.9 Rear Panel Components

**WARNING**

The Vela is designed to ensure that the user and patient are not exposed to excessive leakage current per applicable standards (UL2601 and IEC60601-1). However, this cannot be guaranteed when external devices are attached to the ventilator.

To prevent the risk of excessive enclosure leakage current from external equipment attached to the printer or video ports, the protective earth paths must be isolated to ensure proper connection.

This isolation should ensure that the cable shields are isolated at the peripheral end of the cable.

**Oxygen Sensor**

The oxygen sensor is a disposable Galvanic cell located at the bottom rear of the ventilator, behind the air inlet filter. It needs no maintenance except to be replaced at the routine two-year service interval.

**Note**

*If the oxygen sensor becomes depleted before preventive maintenance is performed, you may turn the  $FiO_2$  monitor off. This silences the oxygen  $FiO_2$  alarms. The oxygen blender continues to work unaffected and the  $FiO_2$  parameter setting can still be set to deliver the desired  $FiO_2$ . The  $FiO_2$  monitor can be turned off in the Extended Functions screen as described in Chapter 2. If the  $FiO_2$  monitor is disabled, it is highly suggested that an external oxygen analyzer then be used to verify blender and  $FiO_2$  accuracy.*

**CAUTION**

Service should only be carried out by a trained and certified VIASYS Respiratory Care service technician.

**Connecting Oxygen Sources.**

Vela can accept high or low pressure  $O_2$  sources as shown below.

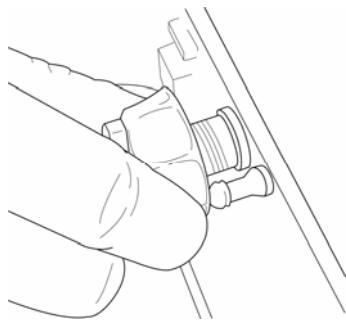
**Attaching a high pressure  $O_2$  Hose**

Attach the high-pressure oxygen hose to the threaded DISS connector on the upper right of the rear panel (see figure 2.10).

Figure 2.10 Connecting the high pressure  $O_2$  hose

**Attaching the low pressure Oxygen tubing**

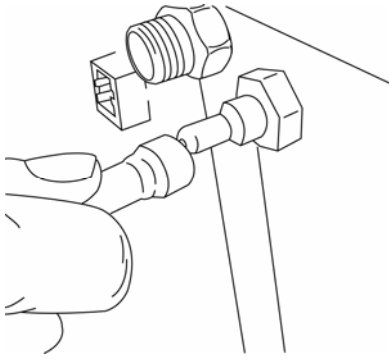

Attach the low pressure oxygen tubing to the tapered connector beneath the high pressure oxygen connector (see figure 2.11). For titration of your patient's  $\text{FiO}_2$  using the low pressure oxygen connector see Appendix C.

---

### **Note**

*Do not use low pressure and high pressure  $\text{O}_2$  connectors at the same time.*

---



---

### **Note**

*When low pressure oxygen is supplied, the  $\text{FiO}_2$  control must be set to 21% to prevent alarms associated with oxygen supply pressure and delivered oxygen concentration. The low pressure oxygen connection adds supplemental oxygen to the patient's breathing gas (see Appendix C).*

---

Figure 2.11 Low pressure oxygen tubing connection

### **Nurse Call Connection**

The Vela can be connected to a remote nurse call system via the modular connector on the rear panel shown in figure 2.9. The jack is configured to interface with normally closed signals (NC, open on alarm) with the use of cable part # 15620, or normally open signals (NO close on alarm) with the use of cable part # 15619.

### **Printer Connector**

The Vela has a standard 25-pin (receptacle) Centronics parallel printer port for interfacing to an HP Deskjet 940C, 5650, or any other compatible printer.

### **SVGA Connector**

There is an SVGA output connector on the rear panel of the Vela to enable real time display of the screen from a separate external display device such as an LCD projector or remote monitor.

### **WARNING**

The Vela is designed to ensure that the user and patient are not exposed to excessive leakage current per applicable standards (UL2601 and IEC60601-1). However, this cannot be guaranteed when external devices are attached to the ventilator.

To prevent the risk of excessive enclosure leakage current from external equipment attached to the printer or video ports, the protective earth paths must be isolated to ensure proper connection.

This isolation should ensure that the cable shields are isolated at the peripheral end of the cable.



## Power up

To power up the ventilator, connect the power cord to a suitable AC power supply and turn on the power switch located on the rear panel of the ventilator as shown here. Protection is provided to the power switch by a moveable protective cover. Accidental interruption of power is immediately notified via the audible alarm. If the ventilator is turned off for any reason or mains power is interrupted the audible alarm sounds.

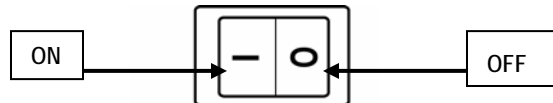

The power up / reboot time for this instrument is a maximum of 12 seconds.

**Figure 2.12 Power Switch Positions**

### WARNING

A protective ground connection by way of the grounding conductor in the power cord is essential for safe operation. If the protective ground is lost, all conductive parts, including knobs and controls which may *appear* to be insulated, can render an electric shock. To avoid electrical shock, plug the power cord into a properly wired receptacle, use only the power cord supplied with the ventilator, and make sure the power cord is in good condition.

### WARNING

If the integrity of the external power earth conductor arrangement is in doubt, unplug the ventilator from the mains AC and operate it from its internal battery

## Extended Functions

The Extended Functions Screen in the Patient Screen Select dialog allows access to stored data and customization of the front panel.

To access Extended Functions, touch the Screen Indicator in the top center section of the touchscreen (see figure 2.13)

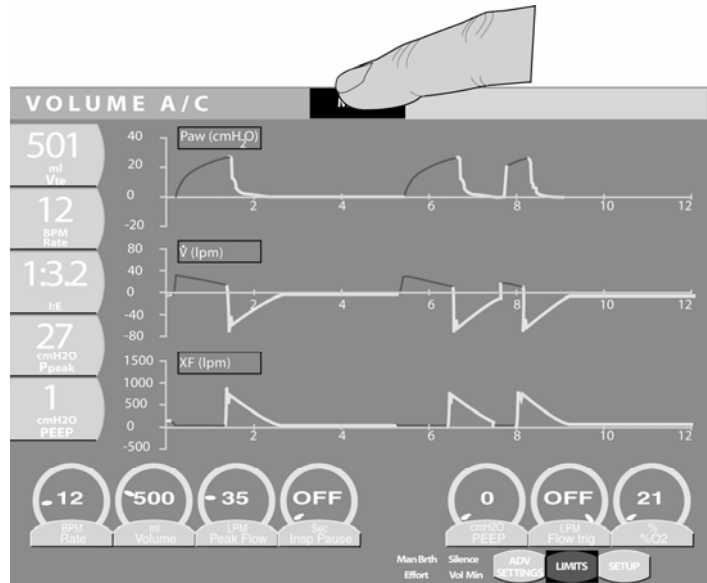
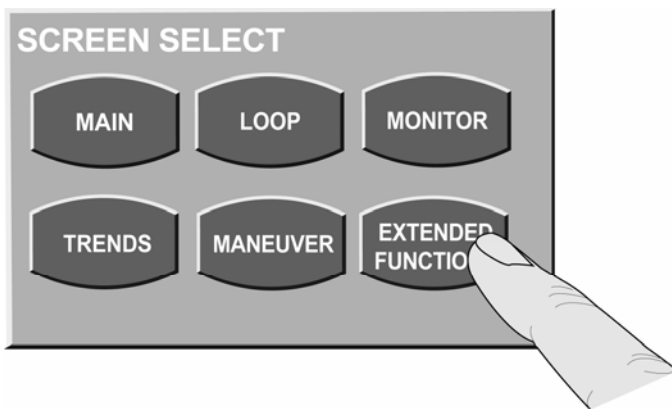

Figure 2.13 Touch the Screens Indicator on the Main Screen



The Screen Select menu appears. Press Extended Functions.

Figure 2.14 Screen Select screen

The Extended Functions Menu appears.

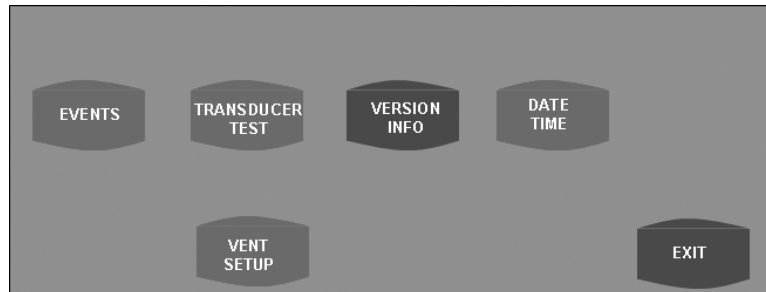

Figure 2.15 Extended Functions Menu

## Extended Functions

The extended Functions menu is available from several different screens within the Vela Software screens. Some of the functions accessible from this screen are for use by a trained Technician when servicing the Vela\*. For a complete explanation of these functions, see your Vela Service Manual.

**Table 2.2 Extended Functions**

Events	Stores Data events for Service evaluation & troubleshooting *
Transducer Test	Allows Service testing of transducer function. *
Version Info	Displays the software version information and the turbine and ventilator serial number.
Date/Time	Displays total hours of ventilator and turbine operation and the date/time configuration.
Vent setup:	Allows setting of these functions:
<i>Low Min Vol</i>	Enable or disable an "OFF" setting for the Low Minute Volume Alarm.
<i>Locks</i>	Enable or disable the front panel lock switch.
<i>FiO<sub>2</sub> Monitor</i>	Turns the FiO <sub>2</sub> monitor on or off. Disabling results in the inability to perform FIO <sub>2</sub> calibration and the inability to monitor the FIO <sub>2</sub> .
<i>Altitude units of measure</i>	Toggles between feet and meters for the altitude setting.
<i>Altitude setting</i>	Allows setting of altitude for accurate volume measurement.
<i>Language buttons</i>	Select the desired language for the front panel.
<i>Ext. Communications</i>	Allows setting of communications choice via MIB Output (VOXP, GSP)
<i>Baud</i>	Allows setting of Baud rate
<i>Format</i>	Allows user to change communication format
<i>End of Msg.</i>	Allows user to change end of message
<i>Neb Time</i>	Allows setting of time (1-60 minutes) nebulizer is active.
<i>Alarm Loudness</i>	Allows setting of alarm loudness
<i>Dim Screen</i>	Allows setting the screen to Dim or Bright
<i>Video Normal/Inverse</i>	Reverses the color configuration of the graphic interface

\* Denotes function for use by trained Service technician.

## Operational Verification Testing

Prior to using the Vela ventilator on a new patient the following checks should be carried out to ensure optimum performance. **Verification testing should always be performed "off patient"**.

### WARNING

Disconnect patient from the ventilator before performing verification testing.

### Note

*All personnel performing preventive maintenance and product repair must be trained and certified by VIASYS Respiratory Care.*

### Note

*If any portion of the following performance check fails, and you are unable to correct the problem, contact your VIASYS Respiratory Care certified service technician.*

### User Verification tests

1. After disconnecting the patient, turn the ventilator OFF (i.e., STANDBY).
2. Press and hold the **Accept** button.
3. While holding the **Accept** button, turn the ventilator ON. Continue to hold the button until the ventilator completes the Power On Self Tests (POST).
4. Release the **Accept** button when the UVT Remove Patient message appears in the screen. The Audible Alarm sounds. Press Alarm Silence button to clear.



**Figure 2.16 UVT Startup Screen**

5. Press the **Patient Removed** touch screen icon. The UVT test selection screen displays (see figure 2.18).

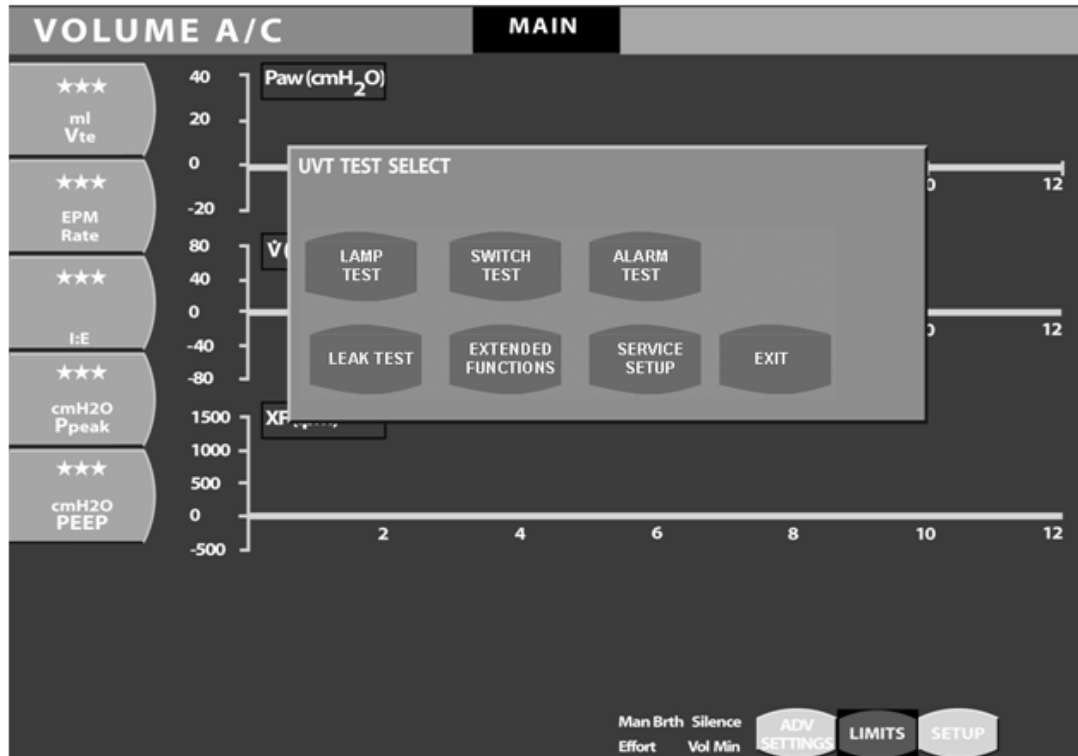

Figure 2.17 The UVT Screen with the Main screen in Service mode

6. Press the appropriate touch screen icon to begin each test.

### *Lamp Test*

Run this test to check the front lamps to make sure they are functioning properly.

1. Press the **Lamp Test** touch screen icon to start the test. The ventilator illuminates all front panel LEDs except the Power LED and the DC LED.
2. Press the **Lamp Test** touch screen icon again to turn the LEDs off and exit the test. You cannot start another test until you exit this test.

## Switch Test

Run this test to check the front panel membrane switches to make sure they are working properly.

1. Press the **SWITCH TEST** icon.
2. Press each membrane switch control in turn. Watch for the name of the control to appear in the message bar at the bottom left of the touch screen as follows:

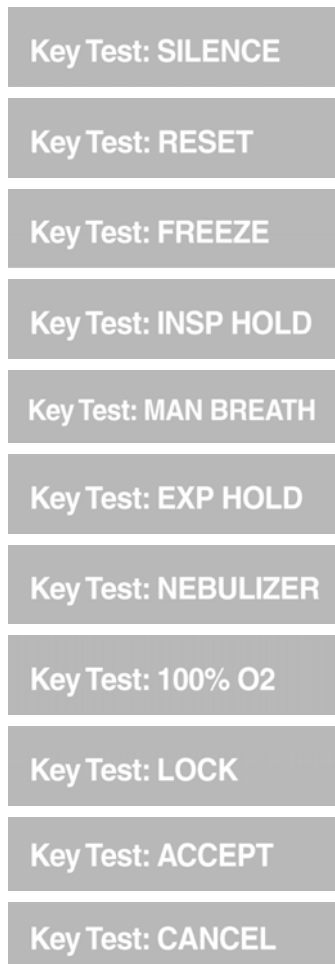

**Figure 2.18** Switch control messages

3. Press the **SWITCH TEST** icon again to exit the test. You cannot start another test until you exit this test.

## Alarm Test

Run this test to check the audible alarm.

1. Press the **Alarm Test** touch screen icon to start the test. The audible alarm sounds.
2. Press the **Alarm Test** touch screen icon again to silence the audible alarm and exit the test. You cannot start another test until you exit this test.

## Leak Test

---

### Note

*This test should be performed with **all circuit accessories installed** (e.g., humidifier, water traps, and so on.) Make sure all connections are secure and all openings occluded before beginning the test.*

---

Run this test to make sure the patient breathing circuit is not leaking.

1. Attach a one-liter test lung at the patient breathing circuit wye.
2. Press the **Leak Test** touch screen icon to run the test. The test begins by increasing the pressure in the patient breathing circuit to 60 cmH<sub>2</sub>O. The ventilator then displays the following messages in sequence:

Leak test requested  
Leak test in progress

3. The ventilator holds and measures the circuit pressure again. If the pressure loss is within acceptable limits, the test passes and the ventilator displays the following message:

xx.x Passed

where xx.x is the ending measurement.

4. Otherwise, the test fails and the ventilator displays the following message:

xx.x Failed

5. If the test fails, check all connections to make sure there are no leaks and repeat the test.
6. If the test fails again, call VIASYS Respiratory Care technical support as shown in Appendix A.

## FiO<sub>2</sub> Monitor Calibration

When the FiO<sub>2</sub> Mon Calibration button is touched, the calibration menu appears. You have a choice of doing an ambient air calibration or a 100% oxygen calibration. Calibration should be completed when the ventilator is off the patient. Calibration take approximately 4 minutes. The calibration is fully automatic once you touch the appropriate button.

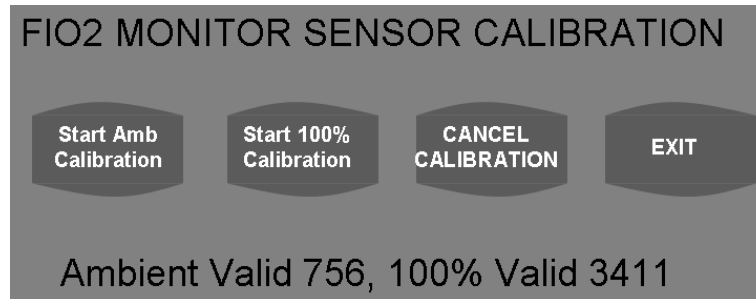

**Figure 2.19 FiO<sub>2</sub> Calibration Screen**

The FiO<sub>2</sub> monitor comes calibrated from the factory. There is normally no need for a routine calibration. If the monitored oxygen concentration falls outside the acceptable error range of the sensor, a "CHK O<sub>2</sub> CAL" alert appears in the alarm indicator bar. Performing a single point calibration (either on the ambient air or 100% O<sub>2</sub>) should correct this alert. If you desire accuracy within the plus or minus 2% range however, a full calibration (both ambient and 100% O<sub>2</sub>) should be performed.

To exit the FiO<sub>2</sub> Calibration screen, touch the **EXIT** touch screen icon.

To exit the Extended Functions screen, touch the **EXIT** Touch screen icon to return to the Main screen.

---

## Note

*If the FIO<sub>2</sub> Monitor is turned OFF, as described in Table 2.2, Extended Functions, it is not possible to calibrate the FIO<sub>2</sub> Monitor. The FIO<sub>2</sub> Monitor must be turned ON to be calibrated.*

---

## Exit

To exit the UVTs press the **EXIT** touch screen icon. The touch screen freezes while the Vela performs the POST test and then begins normal operation.



## Manual Verification Tests:

1. Before attaching the Vela to a new patient, perform the following Operational Verification checks.
2. Attach a test lung to the circuit. (Siemens 190 Adult test lung highly suggested or equivalent)
3. Turn on the Vela, choose New Patient and Accept. This returns all settings to the defaults.
4. Change the Flow Rate setting to 60 LPM.
5. Change the PEEP setting to 5 cmH<sub>2</sub>O.
6. To check monitor performance, allow the ventilator to operate for two minutes. View the monitored parameters. The values should appear as follows:

**Table 2.3 Parameter values**

Parameter	Value
Minute volume (Ve)	6 L ± 1.2 L
Tidal Volume (Mand VT)	500 ml ± 100 ml (10% VT del & 10% VTmonitored)
I:E Ratio	1:3.3 ± 10%
Breath Rate	12 bpm ± 2 bpm
Ppeak	Should equal manometer display + / - 5 cmH <sub>2</sub> O (freeze & measure pressure waveform)
PEEP	0 cmH <sub>2</sub> O ± 2 cmH <sub>2</sub> O
Inspiratory Time (Ti)	1.15 seconds ± 0.05 seconds

3. Check the alarms as follows:
  - a. **Power Fail Check**
    - i. Remove the power cord from the wall. The ventilator should do the following:
      - i. Switch to battery power.
      - ii. Sound the audible alarm.
      - iii. Turn the AC Power Source indicator OFF.
      - iv. Display the BATTERY ON message in the alarm window.
      - v. LED for internal battery lights.
    - ii. Press the Alarm Reset button to clear the alarm.
    - iii. Plug the AC power cord back into the wall socket.
  - b. **High Pressure Limit Check**
    - i. Lower the High Pressure Alarm setting to 5 cmH<sub>2</sub>O below the Peak Inspiratory Pressure (PIP). When the ventilator cycles to inspiration and the high pressure limit is violated, the high pressure alarm should occur. When this happens the ventilator should:
      - vi. Immediately cycle into the expiratory phase.
      - vii. Sound the audible alarm.
      - viii. Display the HIGH PRES message in the alarm window.
    - ii. Return the High Pressure Alarm setting to 5 cmH<sub>2</sub>O above PIP, and press the Alarm Reset button to clear the alarm.

## Pressure Relief Valve

The pressure relief valve (pop-off) sets the maximum pressure allowed in the system. This provides a safety back-up for the High Pressure alarm. This is a variable mechanical relief valve located on the front panel of the ventilator, lower right-hand corner as the user is facing the ventilator. The valve does not terminate inspiration, but releases excessive circuit pressure. The maximum pressure must be set above the High Pressure alarm setting.

The valve is set by rotating it to any value from 0 to 130 cmH<sub>2</sub>O. To set the Pressure Relief Valve, do the following:

1. Attached a test lung to the patient breathing circuit.
2. Set the Pressure Relief Valve to the maximum (130 cmH<sub>2</sub>O).
3. Set the mode to Pressure A/C.
4. Set the High Pressure Alarm to 80 cmH<sub>2</sub>O
5. Set the Inspiratory Pressure to achieve at least 80 cmH<sub>2</sub>O as displayed on the monitor.
6. Monitor the Ppeak.
7. Adjust the Pressure Relief Valve until the pressure shown on the monitor reaches the desired pressure, usually 5 – 15 cmH<sub>2</sub>O above the desired inspiratory pressure.
8. Lower the High Pressure alarm to a value between the Inspiratory Pressure setting and the Pressure Relief setting or as dictated by protocol.

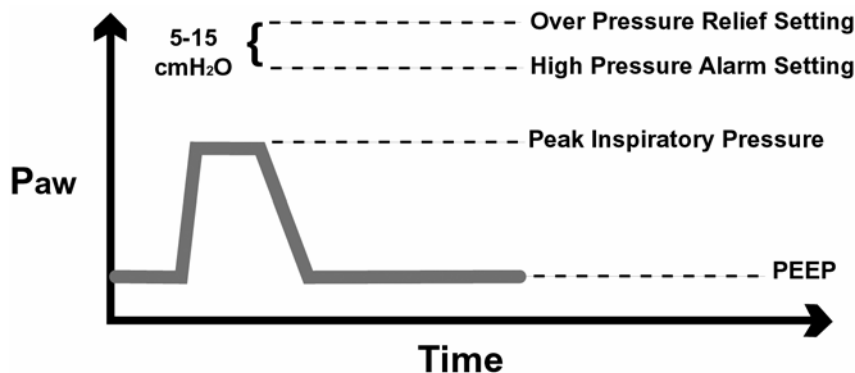

Figure 2.20 Pressure Relief Valve Setting

## Service Set Up

When the service set up button is depressed, ventilator information appears. This screen gives the technician the opportunity to verify Ventilator serial number and model. For password protected enhancements, password is entered and accepted by pressing password accept key.

## Vela Ventilator Performance Checklist

This checklist is for use during the Vela Operational Verification Procedure.

Serial Number \_\_\_\_\_ Hours \_\_\_\_\_ Date \_\_\_\_\_

*Verification Steps*

Verification Step	Check & Initial
1. Inspect the ventilator and components for appearance and cleanliness. Confirm the Exhalation valve, diaphragm, air intake filter, test circuit and test lungs are correctly installed. Wipe the ventilator clean if needed using a cloth moistened with an approved cleaning solution.	<input type="checkbox"/> _____
2. Enter the User Verification Test (UVT). Touch the Patient Removed button.	<input type="checkbox"/> _____
A. LAMP TEST Confirm the proper functioning of the front panel lamps and LEDs.	<input type="checkbox"/> _____
B. SWITCH TEST Confirm the proper functioning of the membrane switches.	<input type="checkbox"/> _____
C. ALARM TEST Test the alarm volume. Adjust as required.	<input type="checkbox"/> _____
D. LEAK TEST Check the patient breathing circuit on the ventilator and conduct a leak test. Make sure all needed components are firmly attached in the circuit.	<input type="checkbox"/> _____
3. Complete the O <sub>2</sub> calibration.	<input type="checkbox"/> _____
4. Exit the UVT and begin conducting a brief performance test. Accept <b>New Patient</b> to enable default settings and close Patient Setup screen.	<input type="checkbox"/> _____

Verification Step	Check & Initial
5. After at least two minutes of operation compare the displayed readings to the following:	<input type="checkbox"/> _____
<b>Parameter</b>	<b>Value</b>
Minute Volume	6 L $\pm$ 1.2 L
Tidal Volume	500 ml $\pm$ 100 ml
I:E Ratio	1:3.3 $\pm$ 10%
Breath Rate	12 bpm $\pm$ 2 bpm
Ppeak	Should equal monitor display + / -5 cmH <sub>2</sub> O
PEEP	0 cmH <sub>2</sub> O $\pm$ 2 cmH <sub>2</sub> O
Inspiratory Time	1.15 sec $\pm$ 0.05 sec
6. Set Pressure Relief Valve	<input type="checkbox"/> _____
7. Check alarms	
A. Power Fail Check	<input type="checkbox"/> _____
B. High Pressure Limit Check	<input type="checkbox"/> _____

**Procedure Complete**

Signature: \_\_\_\_\_

Date: \_\_\_\_\_

# Chapter 3 Operation

## Membrane Buttons and LEDs

The Vela membrane panel differs between the International model and the USA model, see figures 3.1 or 3.2 for the panel supplied on your Vela.

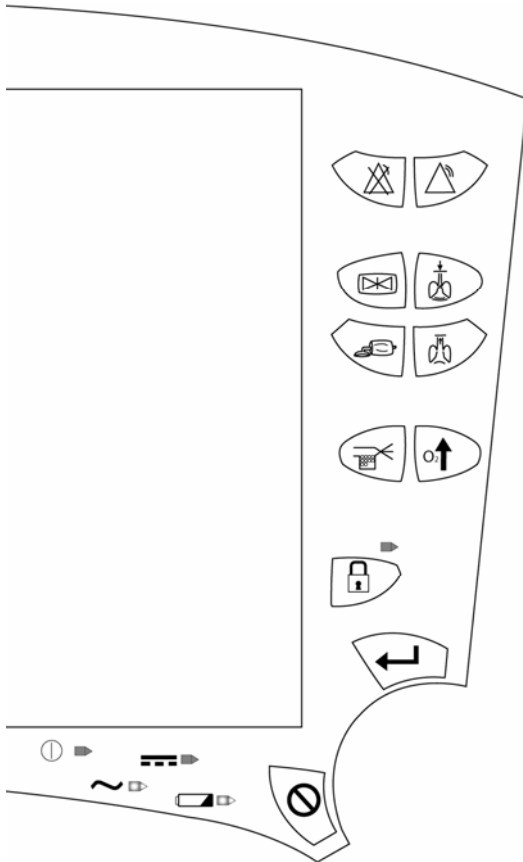

Figure 3.1 Vela Membrane panel (International)

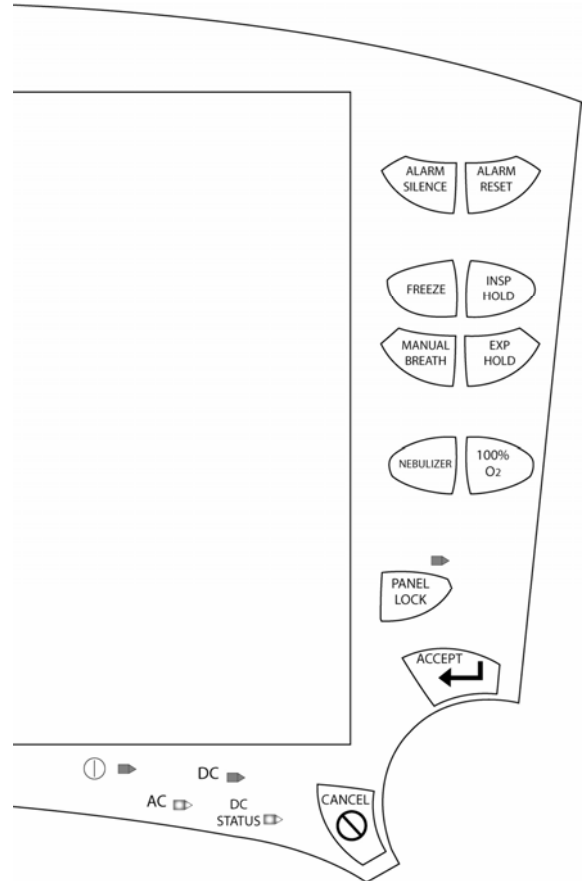



Figure 3.2 Vela Membrane Panel (USA)

### Membrane Button Functions

#### A. Alarm Silence

 Pressing this button disables the audible portion of an alarm for 60 seconds ( $\pm 1$  second) or until the Alarm Silence button is pressed again. This button is not functional for a VENT INOP alarm.

#### B. Alarm Reset

 Cancels the visual indicator for alarms that are no longer active.

### C. Freeze



The FREEZE button freezes the current screen and suspends real-time update of data until pressed again. When the screen is frozen you can scroll through displayed waveforms, trends, or loops using the Data Dial to move the cursor on screen.

Figure 3.3 shows a flow/volume loop in “freeze” mode. As the dotted line cursor traces the “frozen” loop curve, flags display the values along the curve of the loop.

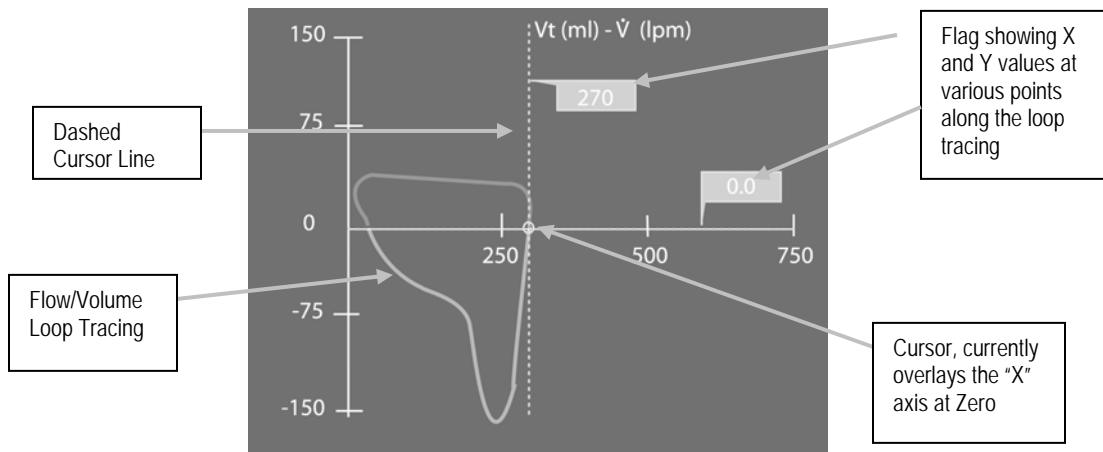

Figure 3.3 Flow/Volume Loop in Freeze Mode

### D. Inspiratory Hold



When the INSP HOLD button is pressed and held, once the preset volume of a volume breath has been delivered, the patient is not allowed to exhale for a maximum of 6 seconds.

### E. Expiratory Hold



When the EXP HOLD button is pressed and held, at the start of the next breath interval the ventilator does not allow the patient to inspire or exhale for a maximum of 6 seconds.

### F. Manual Breath



Pressing this button during the expiration phase of a breath delivers a single mandatory breath at current ventilator settings. No breath is delivered if the button is pressed during inspiration.

## Note

*To quickly resume ventilation after suctioning or other procedures, press the manual breath button.*

## G. Synchronized Nebulizer



When an in-line nebulizer is attached and the Nebulizer button is pressed, the ventilator supplies nebulized gas to the patient at 6 L/min (see the Nebulizer section of Chapter 2 Unpacking & Setup for attachment instructions).

The standard in-line nebulizer is powered by 100% oxygen for delivery of prescribed medications in the ventilator circuit. When nebulization is active, the nebulizer flow is synchronized with the inspiratory phase of each breath and can be adjusted in increments of 1 minute for a maximum of 60 minutes. You may end the nebulization period early by pushing the Nebulizer button again.

Since the Nebulizer is powered by 100% oxygen, your patient's  $FiO_2$  is slightly elevated during the period of nebulization. Use of an independent  $FiO_2$  monitor is recommended, to more accurately determine the  $FiO_2$  delivered to the patient during nebulization. The resulting  $FiO_2$  can be estimated by the following equation:

$$\text{New } FiO_2 = [(V_{ti} \times FiO_2) + (0.1 \times Ti)] \text{ divided by } [V_{ti} + (0.1 \times Ti)]$$

Where:

*$V_{ti}$*  = monitored  $V_{ti}$  before turning the nebulizer on.

*Set  $FiO_2$*  =  $FiO_2$  setting as a decimal (e.g.  $FiO_2$  of 40 is 0.4)

*$Ti$*  = monitored I-time before turning the nebulizer on

### CAUTION

Using the nebulizer may impact patient volumes. During volume control breaths, approximately 50ml is added to the Tidal Volume for every 0.5 seconds of inspiratory time. If this added volume is undesirable for your patient, adjust the set Tidal Volume appropriately.

This added volume also slightly increases the Peak Pressure. Properly set High Pressure alarms help protect the patient from injury. Backpressure from a nebulizer can reduce nebulizer flow. This backpressure varies depending on the manufacturer and/or brand of nebulizer used. The user should be aware of this and take steps to account for the effect of backpressure. Neither volume nor peak pressure is affected for Pressure Control or Pressure Support breaths.

### CAUTION

Use of an external flow meter to power the nebulizer is not recommended.

### WARNING

Using the nebulizer may impact your patient's volumes.

## H. 100% O<sub>2</sub>



When this button is pressed, the ventilator increases the oxygen concentration delivered to the patient to 100% for 3 minutes. If the 100 %O<sub>2</sub> button is pressed again within the three-minute period, the maneuver is cancelled and the ventilator returns to the prior settings for  $FiO_2$ .

**I. Panel Lock**

The PANEL LOCK button disables all front panel controls except MANUAL BREATH, 100 %O<sub>2</sub>, ALARM RESET, ALARM SILENCE, and the PANEL LOCK button.

**J. Accept**

Accepts data entered into a field on the touch screen.

**K. Cancel**

Cancels data entered into a field on the touch screen. The ventilator continues to ventilate at current settings.

**L. Message Bar**

Provides user information

Message	Definition
3 Second I Time	Maximum I time reached
Alarm test – in progress	Test Status
Circ pressure XDCR test – in progress / requested	Test Status
Confirm Apnea Settings	Alerts user to confirm apnea settings
Exhl Diff pressure XDCR test – in progress / requested	Test Status
Failed	Test Status
Filter test – in progress / requested	Test Status
FLOW TERMINATION	Terminated by set flow cycle
INSPIRATORY TIME TERMINATION	Breath terminated by set inspiratory time
100% O <sub>2</sub>	100%
ACCEPT	Accept
CANCEL	Cancel
EXP HOLD	Expiratory hold maneuver
FREEZE	Freeze Screen
INSP HOLD	Inspiratory hold maneuver
LOCK	Screen lock
MAN BREATH	Manual breath
NEBULIZER	Nebulizer active
RESET	Alarm – visual reset
SILENCE	Alarm Silence
Lamp test – in progress / OFF / ON	Test Status
Leak test – in progress / requested	Test Status



Message	Definition
Newest	Occurs in event log screen, indicates most recent event
NEW SENSOR	Message to notify the clinician that a new sensor has been detected by the ventilator check
Passed	Test Status
Printer Busy / Error / Offline / Out of Paper / Ready / Printing	Printer function information
Settings Limited – Recheck Settings	Prompts uses to check settings
Turb Diff pressure XDCR test – in progress / requested	Test Status
Volume Limit Termination	Breath terminated by tidal volume limit

### *Printing Screen Information*

The Vela has a standard 25-pin (receptacle) Centronics parallel printer port for interfacing to an HP Deskjet 940C, 5650, or any other compatible printer.

### *Note*

*For a list of printers which are approved for use with the Vela, call Customer Service at the numbers shown in Appendix A*

To print an image of the currently displayed screen, press the PRINT key in the lower right corner of the touch screen. The screen freezes momentarily as the information is output and then updates as the image prints. See figure 2.9, item K for connection.

## Patient Setup

### *Patient Select Screen*

The first screen to appear after you power up the ventilator is the Patient Select screen. You can choose to resume ventilation of the current patient (RESUME CURRENT) or select NEW PATIENT to reconfigure ventilator settings.

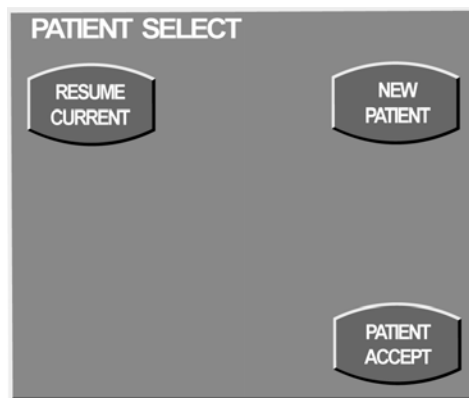

Figure 3.4 Patient Select Screen

The Patient Select Screen defaults to **Resume Current**. If you accept this choice, the ventilator continues ventilation at the most recent patient settings.

The **New Patient** choice clears saved loops and trends and *resets all settings to default values*. Touch the New Patient button to select this choice

Touch Patient Accept to accept your selection. If you selected **New Patient**, ventilation commences with the default settings and the setup screen displays. Patient default message will appear in alarm message box to prompt user to confirm settings. Alarm reset clears message.

---

## Note

*The Ventilation setup screen can also be accessed at any time by pressing the Setup button on the bottom right corner of the touch screen.*

---

## Ventilation Setup Screen

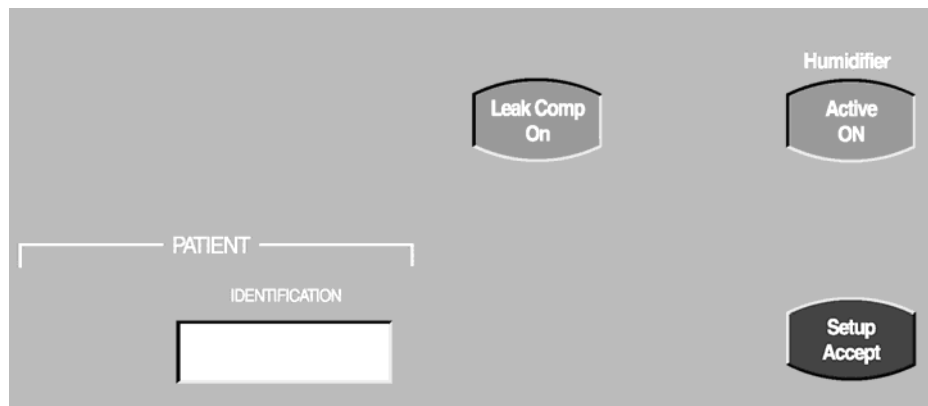

Figure 3.5 Setup

### Humidifier

**HUMIDIFIER ACTIVE** (Active humidification enable/disable), ON/OFF

You can set the type of humidification being used as active (ON) or passive (OFF). Active humidification assumes 37 °C; Passive assumes 25 °C. The relative humidification values compensate the exhaled volumes.

Range: Active ON/OFF

The ventilator delivers and displays tidal volumes as BTPS (**B**ody **T**emperature **P**ressure **S**aturated) corrected.

## Patient Identification

**Patient ID.** In this screen, you may input an alphanumeric patient identification number. To create a patient ID, touch the Touch Screen directly over the Patient IDENTIFICATION field.

A secondary screen appears showing the characters available for patient identification. Rotate the data dial to scroll through the characters. Press the ACCEPT membrane button to accept each character and build your Patient ID code. When the Patient ID code is complete, touch the Touch Screen directly over the Patient IDENTIFICATION field.



Figure 3.6 Data Dial

---

## Note

*All the primary breath controls, at the bottom of the touch screen, are enabled during setup. The Advanced Settings dialog box and the Alarm Limits dialog box are also enabled during setup.*

---

Touch the **SETUP ACCEPT** button to accept the settings as displayed and the ventilator begins ventilation using the changes made while in the Setup Screen.

## NPPV Leak Compensation

You may select Leak Compensation ON or OFF for invasive ventilation modes. It is intended to allow the ventilator to compensate for leaks around tracheal tubes. It will compensate for minor leakages, typically less than 5 liters per minute.

The NPPV Leak Compensation function ensures that any gas flow leakage around a mask (non-vented) or tracheal tube up to 40 liters per minute, in addition to the set bias flow, is automatically determined and compensated for. The determination of leakage amount is made during exhalation after all patient exhalation has occurred. Subsequently, leak comp adjusts bias flow to maintain PEEP and establish a new baseline for patient triggering.

Leak compensation **does not** add a calculated volume to the monitored exhaled volume. Exhaled volume monitoring will continue to indicate the patient's exhaled volume flowing through the exhaled flow sensor.

## Note

Exhaled volume measurement will indicate the patient's exhaled volume minus volume lost to leakage during exhalation.

- The default for invasive ventilation is OFF
- The default for non-invasive ventilation is ON.
- When any of the NPPV modes are selected the leak compensation function is automatically enabled, and when any NPPV mode is exited the leak compensation function returns to its previous or default setting.

- Whenever Leak Compensation is ON, a highlighted status message displays “Lk Comp” at the bottom of the touch screen.

## Setting the Ventilation Breath Type and Mode

To access the mode selection options, touch the Mode indicator at the top left of the touch screen.

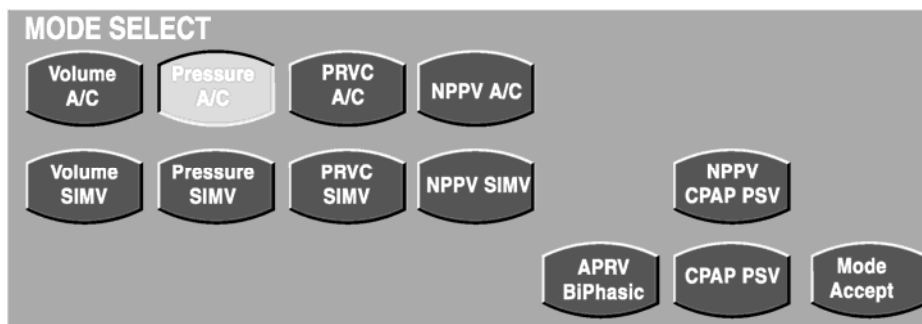

Figure 3.7 Mode Select Screen

The choices displayed in the Mode Select screen are a combination of breath type and ventilation delivery mode.

The following breath type & ventilation modes are available. When a mode is accepted, its name is displayed at the top left of the touch screen.

Table 3.1 Displayed Modes

Displayed Mode	Description
Volume A/C	Volume breath with Assist ventilation (default).
Pressure A/C	Pressure breath with Assist ventilation
Volume SIMV	Volume breath with Synchronized Intermittent Mandatory Ventilation (SIMV)
Pressure SIMV	Pressure Breath with Synchronized Intermittent Mandatory Ventilation (SIMV)
CPAP / PSV	Continuous Positive Airway Pressure (Demand Breath) with Pressure Support Ventilation
APRV / Biphasic	Spontaneous demand breath at two alternating baseline pressure levels or controlled ventilation cycled by time
PRVC A/C	Pressure Regulated Volume Controlled breath with Assist Ventilation
PRVC SIMV	Pressure Regulated Volume Controlled breath with Synchronized Intermittent Mandatory Ventilation (SIMV) and an adjustable level of pressure support for spontaneous breaths.
NPPV A/C	Non-invasive Positive Pressure with Assist Ventilation
NPPV / SIMV	Non-invasive Positive Pressure with Synchronized Intermittent Mandatory Ventilation (SIMV)
NPPV / CPAP PSV	Non-invasive Positive Pressure and Continuous Positive Airway Pressure (Demand Breath) with Pressure Support Ventilation

### Note

Modes listed above are all found in the Vela Comprehensive model. Other Vela models may have a subset of the above modes.

## Apnea Backup Ventilation

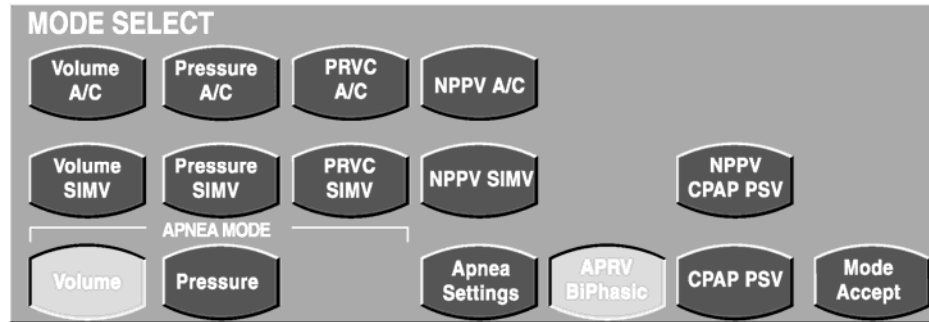

Figure 3.8 Apnea choices in CPAP/PSV mode

The APNEA MODE choices appear when either the APRV/BiPhasic, CPAP/PSV, or NPPV/CPAP PSV mode is selected. Apnea backup is active in all SIMV and CPAP modes. In SIMV, the apnea backup breaths are delivered at the current ventilator breath settings (Volume or Pressure). Apnea backup defaults to a breath rate of 12 unless a higher rate is set. The ventilator ceases apnea backup and resumes ventilation at the current settings once the patient initiates two breaths in a row or the Alarm Reset button is pushed.

### Note

*When APRV/BiPhasic, CPAP/PSV, or NPPV/CPAP PSV is selected, you MUST*

1. *select the breath type for APNEA backup mode*

**AND**

2. *set the primary controls visible at the bottom of the touch screen, for the selected apnea breath type before pressing the MODE ACCEPT button. The controls for the apnea breath type are not visible once the MODE ACCEPT button has been pressed. Only those controls that are active and required for CPAP/PSV remain. You can access the Apnea Backup controls anytime by touching the Mode Indicator at the top left of the screen to open the Mode menu.*

The following section contains a brief description of the breath types and ventilation mode combinations available for adult and pediatric patients.

## Breath Types

There are two basic breath types:

- **Mandatory** breaths (delivered according to set ventilator parameters)
- **Demand** breaths (triggered by the patient)

All breaths are defined by four variables<sup>1</sup>:

- **Trigger** (initiates the breath),
- **Control** (controls the delivery),
- **Limit** (terminates the breath), and
- **Cycle** (how often is the breath delivered).

### Mandatory Breaths

Mandatory breaths can be triggered by the machine, the patient, or the operator. There are 2 mandatory breath types delivered by the Vela.

1. **Volume** breaths which are:

- Controlled by flow (inspiratory);
- Limited by pre-set volume or maximum inspiratory pressure.
- Cycled by volume, flow, and time.

---

## Note

*The Volume Controlled breath is the default breath type.*

---

2. **Pressure** breaths, which are:

- Controlled by pressure (inspiratory + PEEP);
- Limited by pressure (inspiratory + PEEP + margin);
- Cycled by time or flow.

### Demand Breaths

All demand breaths are patient-triggered, controlled by pressure, and patient or time cycled. Demand breaths can be either pressure supported (PSV) or spontaneous.

1. A **PSV (Pressure Support Ventilation)** breath is a demand breath where the pressure level during inspiration is a preset PSV level plus PEEP. PSV breaths are:

- Controlled by pressure (preset PSV level + PEEP);
- Limited by pressure (preset PSV level + PEEP + margin)
- Cycled by time (PSV  $T_{max}$ ) or flow (PSV Cycle).

Pressure Support is active when CPAP/PSV mode is selected

2. A **Spontaneous breath** is a demand breath where the pressure level during inspiration is preset at the PEEP level.

---

<sup>1</sup> *Proceedings of the Consensus Conference on the Essentials of Mechanical Ventilators, by Branson and Chatburn, 1992*

## Ventilation Modes and Breath Types

### Non-Invasive Ventilation

Vela is capable of performing non-invasive positive pressure ventilation (NPPV) with a standard dual-limb or double lumen "F" circuit. Adjust sensitivity to accommodate patient effort without auto-cycling. Activating leak compensation or increasing the level of Bias Flow may help overcome leaks and optimize the sensitivity setting. Set the alarms to avoid unnecessary alerts while maintaining adequate monitoring. If appropriate, you can turn the Low Minute Volume alarm OFF in the Extended Functions Screen (see Chapter 4, Monitors & Displays). NPPV Modes include NPPV/AC, NPPV/SIMV, and NPPV/CPAP/PS.

When any of the NPPV modes are selected the leak compensation function is automatically enabled, and when any NPPV mode is exited the leak compensation function returns to its previous or default setting.

To provide Non-Invasive Positive Pressure Ventilation (NPPV) a face mask or nasal mask is employed to connect the patient to the Vela. The Vela will produce positive pressure breaths to either deliver a mandatory breath or assist the patient's inspiration in one of several NPPV modes (see below).

Since the connection to the patient via a mask may introduce leaks, a leak compensation mechanism is employed to maintain the preset pressures even with introduced leakage up to 40 lpm in addition to the bias flow.

---

### Note

*The mask itself may introduce additional rebreathed volume when compared to a tracheal or tracheostomy tube. The user must consider that additional rebreathed volume may be introduced.*

*The volume of the oro and/or nasopharyngeal airway of the patient should be considered. Even though this volume is the same as a spontaneously breathing patient, it is an additional rebreathed volume when compared to a tracheal tube connection.*

*Normally a small amount of leakage will occur around the mask as the patient moves or the mask is repositioned. This small mask leakage, in many cases, can carry with it some of the exhaled carbon dioxide from the mask, thus reducing added dead space.*

*Only masks, specifically labeled and intended for non-invasive ventilation, should be employed on the Vela. Masks should not have valves or leak vents.*

*Mask Leakage compensation is effective up to 40 lpm plus the bias flow.*

*It is important that a reasonably good mask seal, with the patient's face, should be achieved. Excessive leakage will adversely affect exhaled volume measurement accuracy.*

---

### NPPV A/C

NPPV Assist Control (A/C) is delivered as a Pressure Control breath. Any patient trigger will receive a Pressure Control breath and the breathing pattern is normally time cycled (see Pressure A/C mode for more information).

### NPPV SIMV

NPPV SIMV is a Pressure Control SIMV mode. The SIMV time synchronized mandatory breaths are Pressure Control breaths and the spontaneous breaths are either CPAP type breaths or, at the user's discretion, can be Pressure Support Breaths (see Pressure Support mode for more information).

### NPPV CPAP / PSV

NPPV CPAP/PSV consists of CPAP breathing at the user preset baseline pressure with the option of using Pressure Support as an adjunctive adjustable pressure (See Pressure Support and CPAP).

### Assist Control Ventilation (A/C)

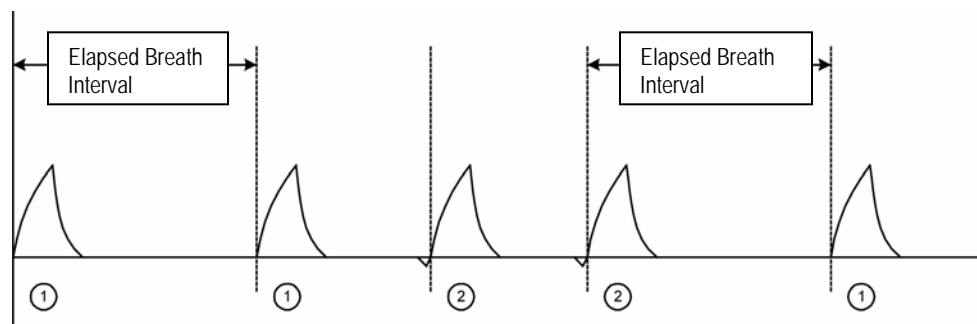

2. Mandatory Breath (Breath Interval Elapsed)

3. Mandatory Breath (Patient Triggered)

Figure 3.9 Assist Control Ventilation Waveform

This is the default mode for all patient types. In Assist Control ventilation mode, *all* breaths initiated and delivered are mandatory breaths. The initiation of a breath is triggered by one of the following:

- patient effort activates the inspiratory trigger mechanism,
- the breath interval, as set by the RATE control, times out,
- the operator presses the MANUAL BREATH button.

Initiation of a breath by any means resets the breath interval timing mechanism. It is possible for the patient to initiate every breath if he/she is breathing faster than the preset breath rate. If the patient is *not* actively breathing, the ventilator automatically delivers breaths at the preset interval (set breath rate). Demand breaths are not possible in Assist/Control mode.



### Synchronized Intermittent Mandatory Ventilation (SIMV)

In SIMV mode, the ventilator can deliver both mandatory and demand breath types. Mandatory breaths are delivered when the SIMV “time window” is open and one of the following occurs:

- a patient effort is detected;
- the breath interval has elapsed with no patient effort detected;
- the MANUAL BREATH button has been pressed.

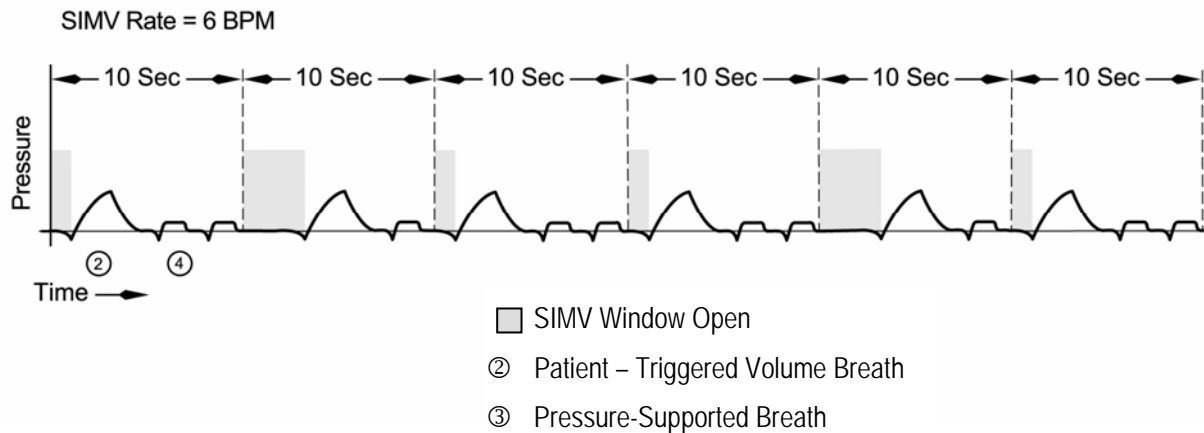

Figure 3.10 SIMV Waveform

The breath interval is established by the preset breath rate. It resets as soon the interval time has elapsed, or when the MANUAL BREATH button is pressed.

**Apnea Backup Ventilation** is active in SIMV mode. During apnea backup ventilation, the ventilator delivers a mandatory breath if no breaths are detected during the apnea “time out” period. In SIMV the breath is delivered at the current ventilator settings with a minimum default rate of 12 breaths per minute. The “timeout” period is determined by the Apnea Interval set in the Alarms screen. A high priority audible and visual alarm occurs when apnea backup ventilation is initiated. The ventilator leaves apnea backup and resumes ventilation at the current settings once the patient initiates two breaths in a row or the Alarm Reset button is pushed.

## Continuous Positive Airway Pressure (CPAP) / Pressure Support Ventilation (PSV)

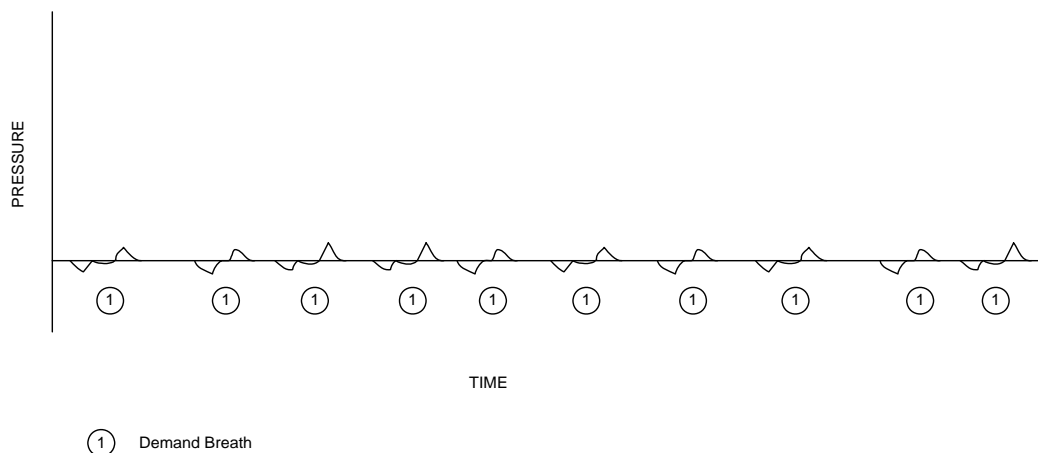

Figure 3.11 CPAP Waveform

In CPAP/PSV mode, all breaths are patient-initiated demand breaths unless the mandatory MANUAL BREATH button is pressed. When the Manual Breath key is pressed, a single breath is delivered at the currently selected Apnea Backup control settings.

**Pressure Support** is active in CPAP mode (see Demand Breaths in this Chapter).

**Apnea Backup ventilation** is active in CPAP/PSV mode. During Apnea Backup, the ventilator automatically initiates a breath when no breaths have been delivered during the preset apnea “time out” interval. The apnea “time out” interval is the Apnea Interval alarm setting.

At the onset of apnea backup ventilation, the ventilator delivers a mandatory breath. The ventilator continues to deliver breaths at the breath settings selected in the APNEA MODE screen during setup, until the patient initiates two consecutive breaths or the Alarm Reset button is pushed.

During setup, a choice of Volume or Pressure breaths is offered for apnea backup delivery. If no selection is made, the ventilator delivers apnea backup breaths at the default breath type and control settings. If the rate is set below 12 breaths per minute, apnea backup defaults to 12.

---

### Note

*When CPAP/PSV is selected, you MUST*

1. select the breath type for APNEA backup mode AND
  2. set the primary controls visible at the bottom of the touch screen, for the selected apnea breath type before pressing the MODE ACCEPT button. The controls for the apnea breath type are not visible once the MODE ACCEPT button has been pressed. Only those controls that are active and required for CPAP/PSV are displayed. You can access the Apnea Backup controls anytime by touching the Mode Indicator at the top left of the screen to open the Mode menu.
-

### Airway Pressure Release Ventilation (APRV / BIPHASIC)

APRV / BiPhasic is a time cycled pressure mode. The ventilator cycles between two different baseline pressures based on time, which can be synchronized with patient effort. Controlled ventilation can be maintained by time cycling the transitions between baseline pressures. Pressure support can be added to improve comfort for the spontaneously breathing patient.

In this mode, the patient is allowed to breathe spontaneously at either of the two preset baseline pressure levels. These are set using the **Pres High** and **Pres Low** controls. The *maximum* duration at each pressure during time cycling is set with the **Time High** and **Time Low** controls.

The operator can also adjust the length of the respective trigger (Sync) windows with the **Time High** and **Time Low** Sync controls, which are advanced settings of Time High and Time Low. The Sync windows are adjustable from 0 to 50%, in 5% increments of set Time High and Time Low.

The ventilator synchronizes the change from Pressure Low to Pressure High with the detection of inspiratory flow **or** the first inspiratory effort detected within the T Low Sync window. Transition from Pressure High to Pressure Low occurs with the first **end of inspiration** detected after the T High Sync window opens.

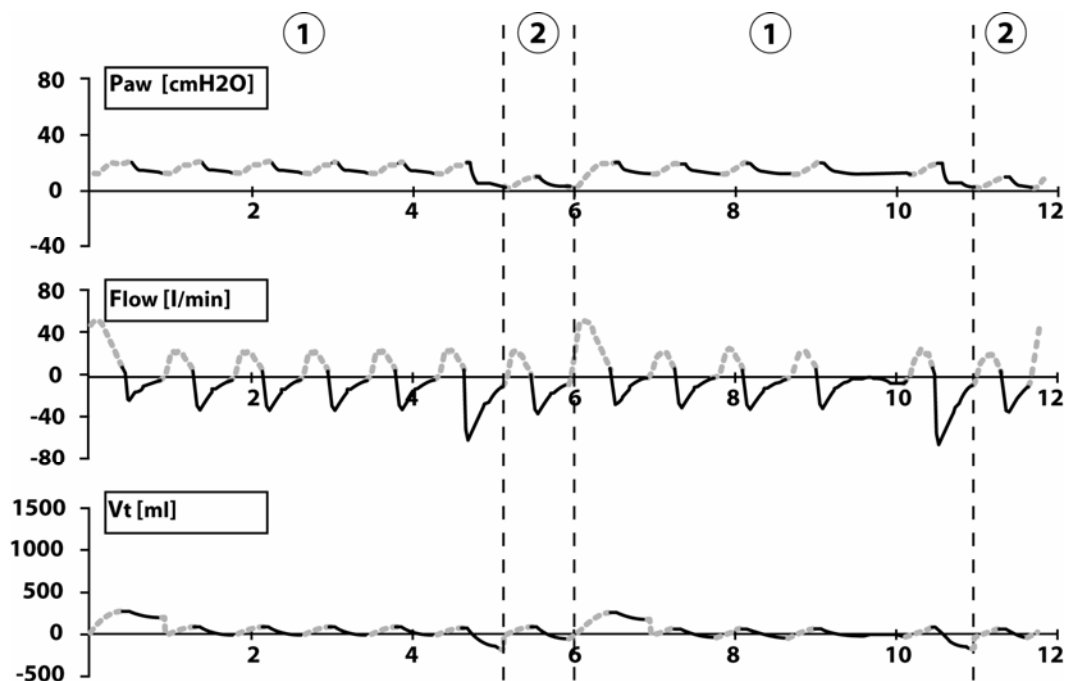

(1) = Time high, Pressure High (2) = Time Low, Pressure Low

**Figure 3.12 APRV / BiPhasic Mode**

Primary controls active in APRV / BiPhasic mode are Time High, Pressure High, Time Low, Pressure Low, Pressure Support, Flow Trigger and %O<sub>2</sub>. Advanced settings available in APRV / BiPhasic mode are T High PSV, T High Sync, T Low Sync, Pressure, Pressure Support Cycle, Pressure Support Tmax and Bias Flow.

**NOTE**

*Time High and Time Low are **maximum** time settings for a time-cycled transition. Actual times may vary depending on the patient's spontaneous breathing pattern and the Sync window setting.*

*Setting the Sync to 0% cycles the transition between pressure levels on time only and will not provide synchronization with patient efforts.*

*The MANUAL BREATH button is not active in APRV / BiPhasic.*

**Adjustable PSV in APRV / BiPhasic**

APRV / BiPhasic features adjustable PSV. The PSV is delivered above the current phase baseline pressure. PSV breaths are available during Time High also, by activating T High PSV (an advanced setting of Time High). If T High PSV is activated, during Time High, the ventilator will deliver the same PSV level for both Pressure Low and Pressure High.

**Apnea Ventilation in APRV / BiPhasic**

Apnea ventilation is available in APRV / BiPhasic. If the patient does not initiate a spontaneous effort, or the ventilator does not time cycle between pressure levels before the apnea interval has elapsed, the ventilator will alarm for apnea and begin apnea ventilation at the apnea ventilation settings. A spontaneous effort from the patient or a transition in baseline pressure will reset the apnea alarm and timer and return the ventilator to APRV / BiPhasic ventilation.

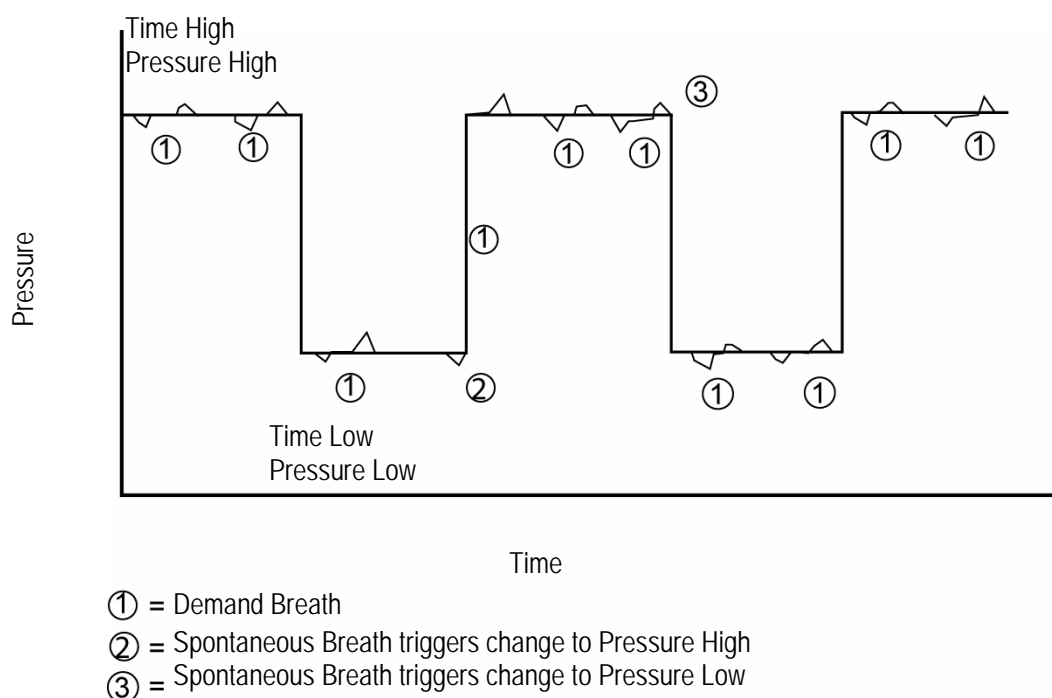
**Airway Pressure Release Ventilation Time Sync (APRV / BIPHASIC)**

**Figure 3.13 APRV / BIPHASIC Time Sync**

### Pressure Regulated Volume Control (PRVC)

Pressure Regulated Volume Control (PRVC) breaths are pressure breaths where the pressure level is automatically modulated to achieve a preset volume. PRVC breaths are:

- Controlled by pressure (inspiratory + PEEP) and volume;
- Limited by pressure (inspiratory + PEEP + margin);
- Cycled by time.

PRVC breath operation is as follows:

- When PRVC is selected, a decelerating flow, volume controlled test breath, to the set tidal volume with a 40 msec pause is delivered to the patient. The demand system is active during this test breath.
- The ventilator sets the target pressure at the *end inspiratory pressure* of the test breath for the first pressure control breath.
- The next breath and all subsequent breaths are delivered as pressure control breaths.
- The inspiratory pressure is based on the dynamic compliance of the previous breath and the set tidal volume.
- The maximum step change between two consecutive breaths is 3 centimeters of water pressure.
- The maximum tidal volume delivered in a single breath is determined by the volume limit setting.

The test breath sequence is initiated when any of the following occur:

- Entering the Mode (PRVC)
- Changing the set tidal volume while in PRVC
- Reaching the Volume Limit setting
- Delivered tidal volume  $\geq 1.5$  times the set volume
- Activation of any of the following alarms
  - High Peak Pressure Alarm
  - Low Peak Pressure Alarm
  - Patient Circuit Disconnect Alarm

#### CAUTION

The Low Pressure alarm must be set at PEEP or above to ensure timely delivery of the test breath.

#### Note

*Alarm limits and Volume Limit should be set in PRVC to prevent inadvertent pressure and volume changes.*

## Modes Associated with the PRVC Breath Type

### PRVC Assist Control (A/C) Mode

All breaths are mandatory breaths. A breath can be triggered by detection of a patient effort, the breath interval timing out or the MANUAL BREATH key being activated.

Initiation of a breath resets the breath interval. A patient may initiate all breaths. When there is no patient effort, breaths are delivered at the set breath rate.

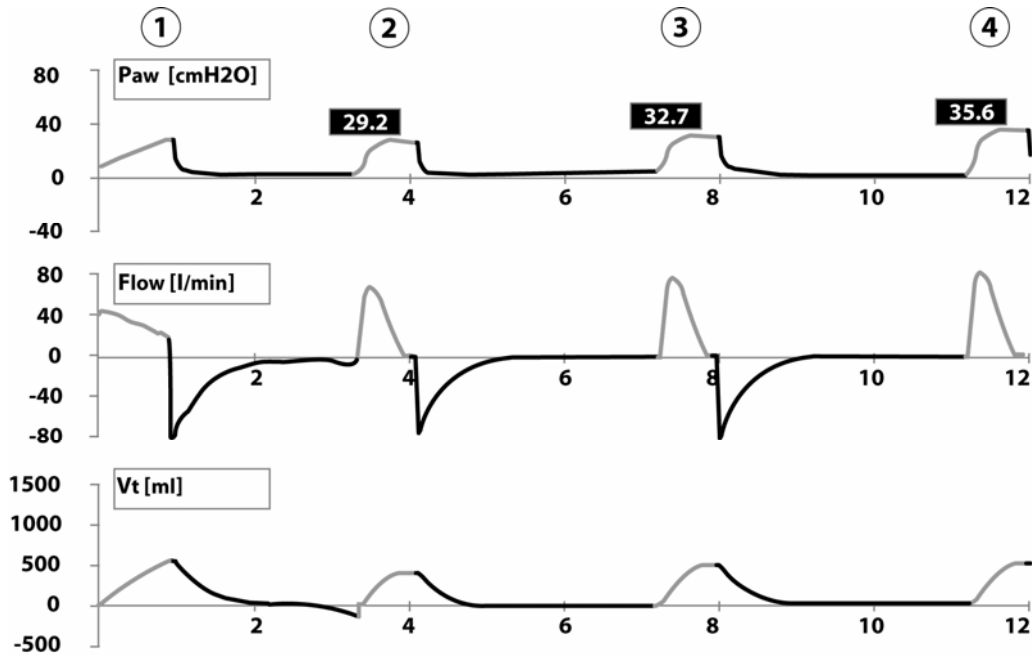

Figure 3.14 PRVC A/C with test breath (1) and step changes (2-4) to achieve target volume

Primary controls active in PRVC A/C mode are Rate, Volume, Inspiratory Time, PEEP, Flow Trigger and %O<sub>2</sub>.

### PRVC SIMV Mode

In SIMV mode, the ventilator can deliver both mandatory and demand breath types. Mandatory breaths are delivered when the SIMV "time window" is open and one of the following occurs: a patient effort is detected, the breath interval has elapsed with no patient effort detected or the MANUAL BREATH key is activated.

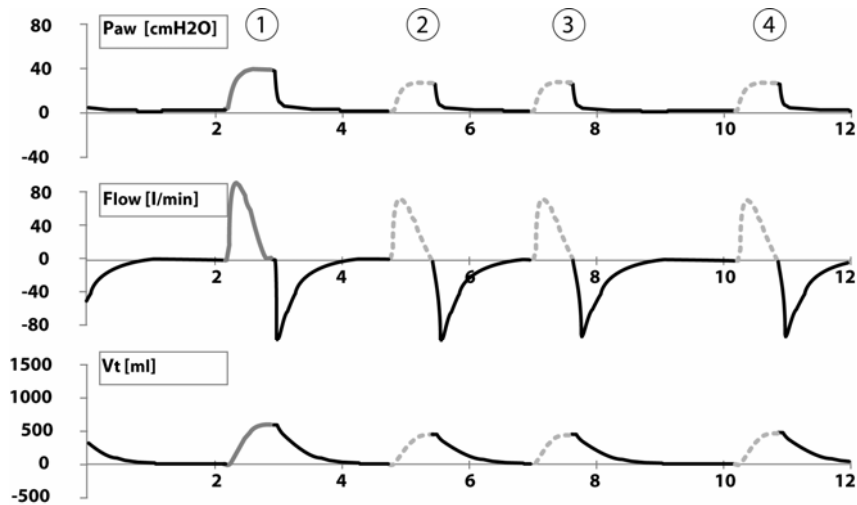

Figure 3.15 PRVC SIMV with mandatory (1) and assisted (2-4) breaths

Primary controls active in PRVC SIMV mode are Rate, Volume, Inspiratory Time, Pressure Support, PEEP, Flow Trigger and %O<sub>2</sub>.

Advanced settings available in PRVC SIMV mode are Volume Limit, Pressure Support Flow Cycle, Pressure Support Tmax, and Bias Flow.

### Primary Breath Controls

The primary breath controls are operator set controls, which directly affect the way a breath is delivered to your patient. They are displayed along the bottom of the touch screen. *Only the controls that are active in the currently selected mode of ventilation are displayed.*

Table 3.2 Primary Breath Controls

Displayed Control	Description	Range
bpm Rate	Breath rate shown in Breaths per Minute	2 to 80 bpm
ml Vt	Tidal Volume in milliliters	50 to 2,000 ml
cmH <sub>2</sub> O Insp Pres	Inspiratory Pressure in centimeters of water pressure	1 to 100 cmH <sub>2</sub> O
L/min Peak Flow	Peak Inspiratory Flow in Liters per Minute	10 to 140 L/min
sec Insp Time	Inspiratory Time in Seconds	0.30 to 10 sec
sec Insp Pause	Sets an inspiratory pause which is in effect for each Volume breath delivered	OFF, 0.1 to 2.0 sec
cmH <sub>2</sub> O PSV	Pressure Support in centimeters of water pressure	Off, 1 to 60 cmH <sub>2</sub> O
cmH <sub>2</sub> O PEEP	Positive end expiratory pressure in centimeters of water pressure	0 to 35 cmH <sub>2</sub> O
L/min Flow Trig	Sets inspiratory flow trigger point in liters per minute	1 to 10 L/min
% %O <sub>2</sub>	Controls the percentage of oxygen in the delivered gas.	21% to 100%

## To Activate a Primary Control

To activate a primary breath control, touch the touch screen directly over the control. The control highlights (changes color) indicating that it is active. To modify the settings for the highlighted control, turn the data dial below the touch screen. Turning in a clockwise direction increases the selected value, turning counterclockwise decreases it.

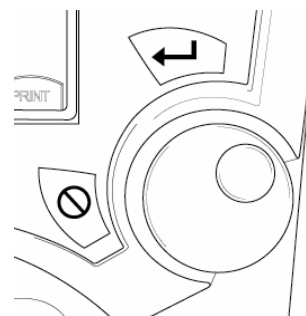

Figure 3.16 The Data Dial.

To accept the displayed value, either touch the touch screen directly over the highlighted control or press the ACCEPT membrane button by the data dial. The control color changes back to normal and the ventilator begins operating with the new setting. If you press the CANCEL button or do not actively accept the new setting within 15 seconds, ventilation continues at the previous settings.

---

## Note

*Not all controls are active in every mode and the effect of some may differ depending on the mode of ventilation selected.*

---

## Descriptions of Primary Breath Controls

### Breath Rate (Rate)

The breath rate control sets the breath interval. Its function is dependent upon the selected mode of ventilation and it has different effects on the breath cycle, depending on which mode is selected.

Range: 2 to 80 bpm

Default: 12 bpm

### Tidal Volume (Volume)

A volume breath delivers a predetermined volume of gas to the patient. Tidal Volume, together with the Insp Flow, and Waveform settings determine how the flow is delivered.

Range: 0.05 to 2.0 L

Default: 0.50 L

Sigh: 1.5 x Volume

### Inspiratory Pressure (Insp Pres)

During a mandatory pressure breath, the ventilator controls the Inspiratory Pressure in the circuit. For Pressure, the pressure achieved is a combination of the preset Insp. Pres. level plus PEEP.

Range: 1 to 100 cmH<sub>2</sub>O

Maximum Flow: 180 L/min

Default: 15 cmH<sub>2</sub>O



### Inspiratory Time (I-Time)

The I-Time control sets the inspiratory time cycle variable for all mandatory breaths.

Range: 0.3 to 10.0 seconds

Default: 0.3 second

### Peak Flow

In a volume mode, the Peak Flow setting controls the flow at which the breath is delivered during the inspiratory phase of a mandatory breath.

Range: 10 to 140 L/min

Default: 35 L/min

### Inspiratory Pause (Insp Pause)

Sets the inspiratory pause time for volume controlled breaths.

Range: Off, 0.1 to 2.0 sec

Default: Off

### PSV (Pressure Support)

The PSV control sets the pressure in the circuit during a pressure supported breath.

Range: Off, 1 to 60 cmH<sub>2</sub>O

Maximum Flow: 180 L/min

Default: Off

### Positive End Expiratory Pressure (PEEP)

PEEP is the pressure that is maintained in the patient circuit at the end of exhalation.

Range: 0 to 35 cmH<sub>2</sub>O

Default: 0 cmH<sub>2</sub>O

### Inspiratory Flow Trigger (Flow Trig)

The inspiratory trigger mechanism is activated when the Net Flow becomes greater than the Inspiratory Flow Trigger setting. Net Flow is defined as [Delivered Flow – Exhaled Flow].

Range: 1 to 20 L/min

Defaults: 2 L/min

**%O<sub>2</sub>**

The % O<sub>2</sub> control sets the percentage of oxygen in the delivered gas.

Range: 21 to 100%

Default: 21%

**Pressure High (Pres High)**

This control is only available in APRV / BIPHASIC Mode. It controls the baseline pressure achieved during Time High.

Range: 0 to 60 cmH<sub>2</sub>O

Default: 15 cmH<sub>2</sub>O

**Time High**

Available in APRV / BIPHASIC mode only, this control sets the maximum time for which the Pressure High setting is maintained.

Range: 0.3 to 30 seconds

Default: 4 seconds

**Time Low**

In APRV / BIPHASIC mode, this control sets the maximum time for which the Pressure Low setting is maintained.

Range: 0.3 to 30 seconds

Default: 2 second

**Pressure Low**

In APRV / BIPHASIC Mode, this control sets the baseline pressure achieved during Time Low.

Range: 0 to 45 cmH<sub>2</sub>O

Default: 6 cmH<sub>2</sub>O

## Advanced Settings

When the mode and the primary breath controls have been set, you can further refine delivery of the breath by accessing the Advanced Settings from within the currently set mode. Advanced settings allow you to make specific refinements to each primary breath control setting.

### *Accessing the Advanced Settings*

To access the advanced settings, touch the ADV SETTINGS button located at the bottom right of the touch screen with the Limits, Setup and Print buttons (see figure 3.14). The Advanced Settings window appears. When you select a primary control by touching and highlighting the control, the available advanced settings for that selected control appears in the advanced settings window.



Figure 3.17 Accessing the advanced settings screen



Figure 3.18 Advanced settings indicator

---

### ***NOTE:***

*Primary Controls, which feature an advance setting, will display a yellow triangle to the right of the control name.*

---

### ***NOTE:***

*Not every primary control will have an associated advanced setting.*

---

Table 3.3 Controls and Advanced Settings Associated with Breath Type &amp; Mode

<i>BREATH TYPE &amp; MODE</i>	VOL A/C	VOL SIMV	PRES A/C	PRES SIMV	PRVC A/C	PRVC SIMV	CPAP / PSV	APRV / BIPHASIC	NPPV A/C	NPPV / SIMV	NPPV / CPAP / PS
<b>PRIMARY CONTROLS</b>											
RATE bpm	√	√	√	√	√	√			√	√	
VOLUME ml	√	√			√	√					
INSP PRES cmH <sub>2</sub> O			√	√							
NPPV INSP PRES cmH <sub>2</sub> O									√	√	
PEAK FLOW L/min	√	√									
INSP TIME sec			√	√	√	√			√	√	
INSP PAUSE sec	√ (NOT IN VSYNC)	√ (NOT IN VSYNC)									
PSV cmH <sub>2</sub> O		√		√		√	√	√			
NPPV PSV cmH <sub>2</sub> O										√	√
PEEP cmH <sub>2</sub> O	√	√	√	√	√	√	√	√	√	√	√
FLOW TRIG L/min	√	√	√	√	√	√	√	√	√	√	√
% OXYGEN %O <sub>2</sub>	√	√	√	√	√	√	√	√	√	√	√
PRES HIGH cmH <sub>2</sub> O								√			
TIME HIGH sec								√			
TIME LOW sec								√			
PRES LOW cmH <sub>2</sub> O								√			
APNEA (PRESSURE & VOLUME) SETTINGS							√	√			√
<b>ADVANCED SETTINGS AVAILABLE WITHIN EACH MODE</b>	Vsync (Vol limit, Flow Cycle), Sigh, Waveform Bias flow	Vsync, Sigh, Waveform, PSV cycle, PSV Tmax, Bias flow, Vol limit*, Flow Cycle*	Assured Vol, PC Flow cycle, Bias flow	Assured Vol, PC Flow cycle, PSV cycle, PSV Tmax, Bias flow	Bias flow, Vol Limit, PC Flow cycle	Vol limit, PC Flow cycle, PSV cycle, PSV Tmax, Bias flow	PSV cycle, PSV Tmax, Bias flow	PSV cycle, PSV Tmax, Bias flow, T High Sync, T High PSV, T Low Sync	PC Flow cycle, Bias flow	PC Flow cycle, PSV cycle, PSV Tmax, Bias flow	PSV cycle, PSV Tmax, Bias flow

## Advanced Settings Characteristics and Ranges

### Assured Volume (Comprehensive)

The **Assured Volume** control, when activated, sets the **minimum** tidal volume, delivered from the ventilator, in a pressure controlled breath. This control is always used with the time cycling criterion in pressure control ventilation.

Once you set the **Assured Volume**, the ventilator calculates the **inspiratory flow required** to deliver the Assured Volume in the set inspiratory time. When a Pressure Control breath is delivered and Peak Flow decelerates to this calculated inspiratory flow, and if the Assured Volume has not been met, the ventilator will automatically transition to a continuous flow inspiration to assure that the preset Assured Volume has been delivered. Once the inspiratory time has elapsed and the Assured Volume has been delivered the ventilator will cycle into exhalation. When the Assured Volume is **met or exceeded** during delivery of the pressure control breath, the ventilator will complete the breath as a **normal Pressure Control** breath.

Minimum tidal volume delivered from the ventilator when the Assured Volume control is active in a pressure control breath.

Range: OFF, 0.05 to 2.0 L  
Defaults: OFF

### PC Flow Cycle

The flow cycle setting sets the percentage of the peak inspiratory flow (Peak Flow), at which the inspiratory phase of a Pressure breath is terminated.

Range: 0 (Off) to 70%  
Default: 0% (Off)

Flow cycling is active for Pressure Control breaths only.

### Volume Limit

The Volume Limit setting sets the volume limit for a pressure breath and is active for PRVC/Vsync breaths only. When the volume delivered to the patient meets or exceeds the preset Vol Limit, the inspiratory phase of the breath is terminated. When the volume limit threshold has been reached, the ventilator alarm status indicator changes to yellow and displays the words "Volume Limit". The alarm status indicator cannot be reset until the ventilator has delivered a breath that does not meet the volume limit threshold. To reset the alarm status window use the alarm reset button.

Range: 0.05 to 2.50 L  
Default: 2.50 L

---

## Note

*Excessive inspiratory flow rates or highly compliant ventilator circuits may allow delivery of a tidal volume that exceeds the volume limit setting. This is due to the ventilator circuit recoiling and providing additional tidal volume to the patient. Delivered tidal volumes should be closely monitored to ensure Volume Limit accuracy.*

---

## Vsync

Vsync may be selected in **Volume Assist Control and Volume SIMV modes**. When selected is generates a decelerating flow, volume **test breath** to the set tidal volume. A 40 millisecond post-inspiratory pause is generated during this test breath. The ventilator **sets the target pressure**, for the next breath, utilizing this post-inspiratory pause pressure, for the **Pressure Control breath**. The next breath and all **subsequent breaths** are delivered as **Pressure Control** breaths. Inspiratory pressure is adjusted automatically by the ventilator to **maintain the target volume** based on the dynamic compliance of the previous breath. The maximum step change between two consecutive breaths is 3 centimeters of water pressure. The **maximum** tidal volume delivered in a single breath is determined by the **Volume Limit setting**.

Vsync breaths are:

- Controlled by pressure (inspiratory + PEEP) and volume
- Limited by pressure (inspiratory + PEEP + margin)
- Cycled by time or flow. Inspiratory time in Vsync is determined indirectly by setting the peak inspiratory flow. The set inspiratory time is displayed in the message bar.

Vsync breath operation is as follows:

This test breath sequence is initiated when any of the following occur:

- Entering the Mode (Vsync)
- Changing the set tidal volume while in Vsync
- Reaching the Volume Limit setting
- Delivered tidal volume > 1.5 times the set volume
- Activation of any of the following alarms
  - High Peak Pressure
  - Low Peak
  - Patient Circuit Disconnect

## Waveform

On the Comprehensive model, during the delivery of a volume breath, flow can be delivered in one of two user selectable waveforms: Decelerating or Square. The default waveform for all models is Decelerating Wave.

### Decelerating Wave (Decel)

The ventilator delivers gas starting at the peak flow setting and decreasing until the flow reaches 50% of the set peak flow.

### Square Wave (Square) (Comprehensive only)

The ventilator delivers gas at the set peak flow for the duration of the inspiration.

### Sigh

The ventilator delivers sigh volume breaths when this setting is ON. A sigh volume breath is delivered every 100<sup>th</sup> breath or every 7 minutes whichever, comes first in place of the next normal volume breath.

Range:	Off, On (every 100 breaths or 7 minutes)
Sigh Volume:	1.5 times set tidal volume
Sigh Breath Interval (sec):	Set Normal Breath Interval x 2 (Assist mode) <u>or</u> set Normal Breath Interval (SIMV mode)
Default:	Off

Sigh breaths are only available for Volume breaths in Assist and SIMV modes.

### Bias Flow

Range:	10 to 20 L/min
Defaults:	10.0 L/min

### PC Flow Cycle

Sets the percentage of peak inspiratory flow at which the inspiratory phase of a PC breath is terminated.

Range:	5 to 70%
Default:	Off

### PSV Cycle

Sets the percentage of peak inspiratory flow at which the inspiratory phase of a PSV breath is terminated.

Range:	5 to 30%
Default:	25%

### PSV Tmax

Controls the maximum inspiratory time of a pressure-supported breath.

Range:	0.3 to 3.0 seconds
Default:	3.0 seconds

### % T High Sync

% T High Sync sets the trigger (sync) window to transition from Pressure high to Pressure low. This transition occurs at the first end of the inspiration detected after the Sync window opens.

Range:	0 – 50 %
Default:	0%

**T High PSV**

T High PSV allows pressure support to be active in Time High. Pressure Support in Time High is delivered at the same PSV level as Pressure Low.

Range: 0 = OFF, 1 = ON

Default: 0 = OFF

**% T Low Sync**

% T Low Sync sets the trigger (sync) window to transition from Pressure low to Pressure high. This transition occurs with the detection of inspiratory flow or the first inspiratory effort detected after the Sync window opens.

Range: 0 – 50%

Default: 0%



# Chapter 4 Monitors and Displays

## Graphic Displays

### *The Main Screen: Waveforms*

Three waveforms can be selected and simultaneously displayed on the MAIN screen as shown in figure 4.1. A red tracing indicates the inspiratory portion of a mandatory breath. A yellow tracing indicates the inspiratory portion of an assisted or spontaneous breath. A blue tracing represents the expiratory phase of a breath.

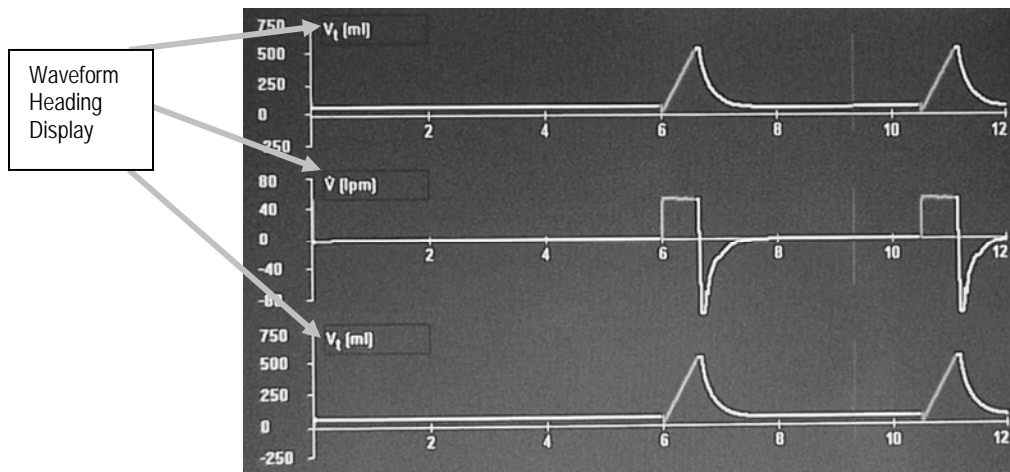

Figure 4.1 Waveform Graphs Displayed on the Main Screen

When you touch and highlight the waveform heading display on the touch screen a scrollable menu appears showing the choice of waveforms.

To scroll through the choices, turn the data dial below the touch screen. To make your selection, press the Accept membrane button next to the data dial.

Each waveform is continuously updated unless the Print touch screen button or the FREEZE membrane key is pressed. Touching Print freezes the display momentarily while data is transferred to a connected parallel printer. Once the data is captured for printing, the active screen update resumes.

The FREEZE membrane button suspends the screen update until pressed a second time.

**Table 4.1 Waveform Choices**

Heading Display	Waveform Shown	Range
$P_{aw}$ (cmH <sub>2</sub> O)	Airway Pressure	Minimum: -5 to +10 cmH <sub>2</sub> O Maximum: -60 to +120 cmH <sub>2</sub> O
V (L/min)	Flow	Minimum: -6 to +6 L/min Maximum: -300 to +300 L/min
$V_t$ (ml)	Airway Tidal Volume	Minimum: -20 to +60 ml Maximum: -700 to +2100 ml

## Axis Ranges

The scale (vertical axis) and sweep speed (horizontal axis) of the displayed graphs are also modifiable using the touch screen. To change the displayed range, touch either axis of the displayed graph to highlight it. The highlighted axis can then be modified using the data dial below the touch screen. To accept the change, touch the highlighted axis again or press Accept.

## *The Loops Screen (Comprehensive model only)*

To access the loops screen:

1. Touch the screen indicator in the top center window that indicates the current screen configuration.
2. The Screen Select box displays.
3. Select LOOP from the menu that appears.

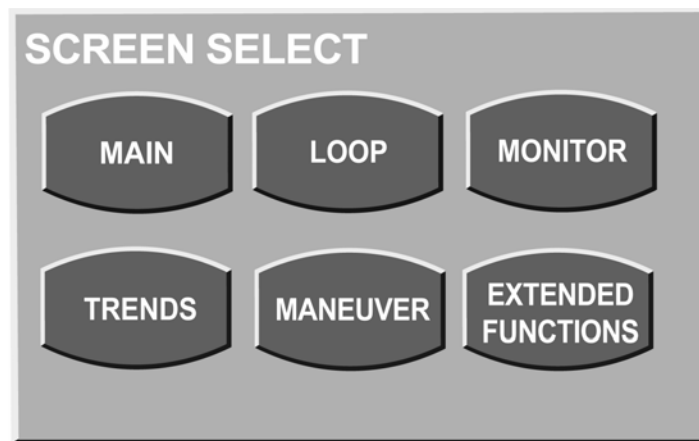

Figure 4.2 Screen Selection

The ventilator is able to display up to 2 loops in real time, selected from the following.

### Flow / Volume Loop

When selected, the ventilator displays a Flow / Volume loop within the following ranges.

#### Flow Ranges:

Minimum: -6 to +6 L/min  
Maximum: -300 to +300 L/min

#### Volume Ranges:

Minimum: 0 to 60 ml  
Maximum: 0 to 2000 ml

### Pressure / Volume Loop

#### Pressure Ranges:

Minimum: -5 to +10 cmH<sub>2</sub>O  
Maximum: -60 to +120 cmH<sub>2</sub>O

#### Volume Ranges:

Minimum: 0 to 60 ml  
Maximum: 0 to 2000 ml

### Using the Freeze Button to Compare Loops

On the Comprehensive model, you can freeze the Loops screen and select a reference loop for comparison. Once real-time data refresh resumes (by pressing the Freeze button again), the selected loop remains in the background behind the real time graphic. To create a reference loop refer to figure 4.3, 4.4 and 4.5 and do the following.

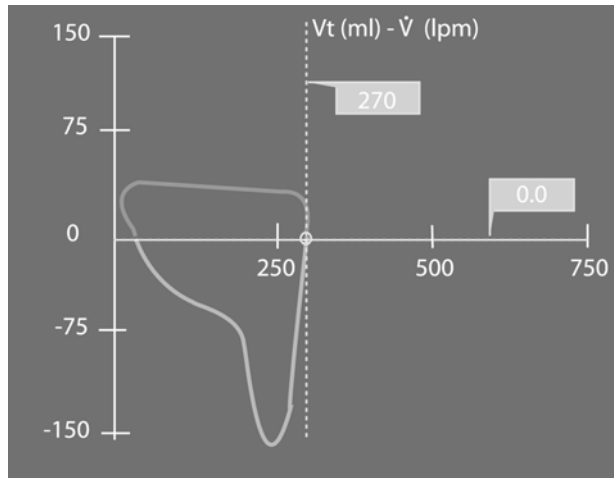

Figure 4.3 Flow/Volume Loop Frozen

Touch the Save Loop button displayed in the bar on the right, beneath the frozen graphic display. See figure 4.4 below.



Figure 4.4 Loop Comparison Buttons

This puts the selected loop into memory and places a time reference into a field in the bar on the left beneath the graphics display as shown in figure 4.5. A total of four (4) loops can be saved at one time.



Figure 4.5 Saved Loops Display

Touch the screen directly over the reference loop you wish to use as a comparison. The reference highlights (changes color). See figure 4.5.

Touch the Ref Loop button on the right side of the bar until it toggles to On.

When you touch the Freeze button again, the reference loop remains in the background and the screen refreshes loops in real time over it. To turn off this feature, freeze the screen again and toggle the Ref Loop button to Off by touching it.

## Digital Displays

### *The Monitor Screen*

To access the monitor screen:

1. Touch the screen indicator in the top center of the Main Screen display.
2. The Screen Select box displays, see figure 4.6.
3. Select MONITOR from the selection box that appears.

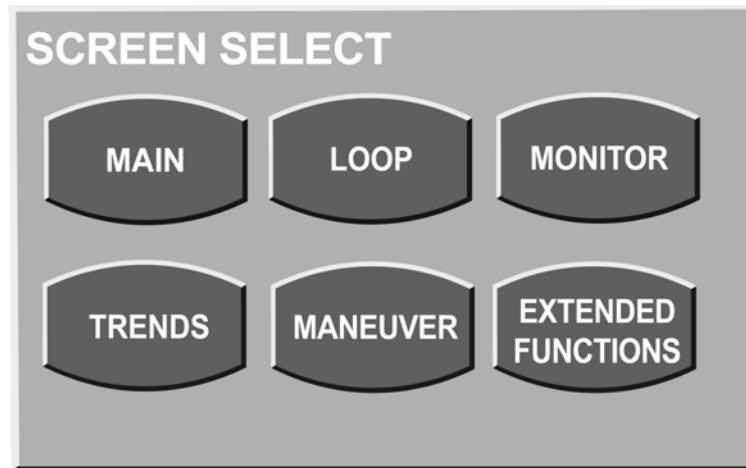

Figure 4.6 Screen Select Box

The monitor screen displays a total of 15 different monitored values simultaneously. Each value can be independently selected from a menu of possible choices (see table 4.2).

1. Use the touch screen to select and highlight the value to be displayed.
2. Turn the data dial beneath the touch screen to scroll through the menu choices.
3. To accept your selection, press the accept button adjacent to the data dial.

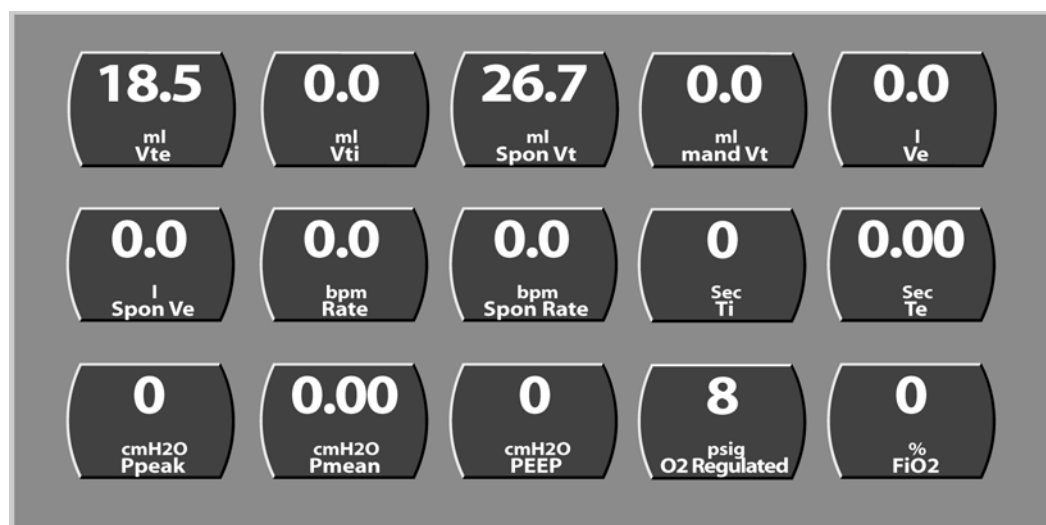

Figure 4.7 The Monitor Screen

**Table 4.2 Monitored Values Menu Choices**

<b>Display</b>	<b>Value</b>
Vte (ml)	Expired tidal volume
Vti (ml)	Inspired tidal volume
Spon Vt (ml)	Spontaneous tidal volume
Mand Vt (ml)	Mandatory tidal volume
Ve (L)	Minute Volume
Spon Ve (L)	Spontaneous minute volume
Rate (bpm)	Breath Rate
Spon Rate (bpm)	Spontaneous breath rate
sec (Ti)	Inspiratory time
Te (sec)	Expiratory Time
I:E	Inspiratory/Expiratory ratio
Ppeak (cmH2O)	Peak inspiratory pressure
Pmean (cmH2O)	Mean inspiratory pressure
PEEP (cmH2O)	Positive end expiratory pressure
O <sub>2</sub> Regulated (psig)	Oxygen regulated inlet pressure
FiO <sub>2</sub> (%)	Percentage of oxygen

### *Main Screen Monitors*

Five parameters are continuously displayed on the Main screen to the left of the waveform displays. These are configurable in the same way as the displays on the Monitors screen.

1. Use the touch screen to select and highlight the value to be displayed.
2. Turn the data dial beneath the touch screen to scroll through the menu choices.
3. To accept your selection, press the accept button adjacent to the data dial.

### The Trends Screen (Comprehensive model only)

The monitored parameters described in the previous section are trended as one minute averaged values over a running 24-hour period. To access the Trends screen, press the screen indicator in the top center portion of the touch screen display. The screen menu appears. Press the TREND button on the screen menu to open the trends screen.

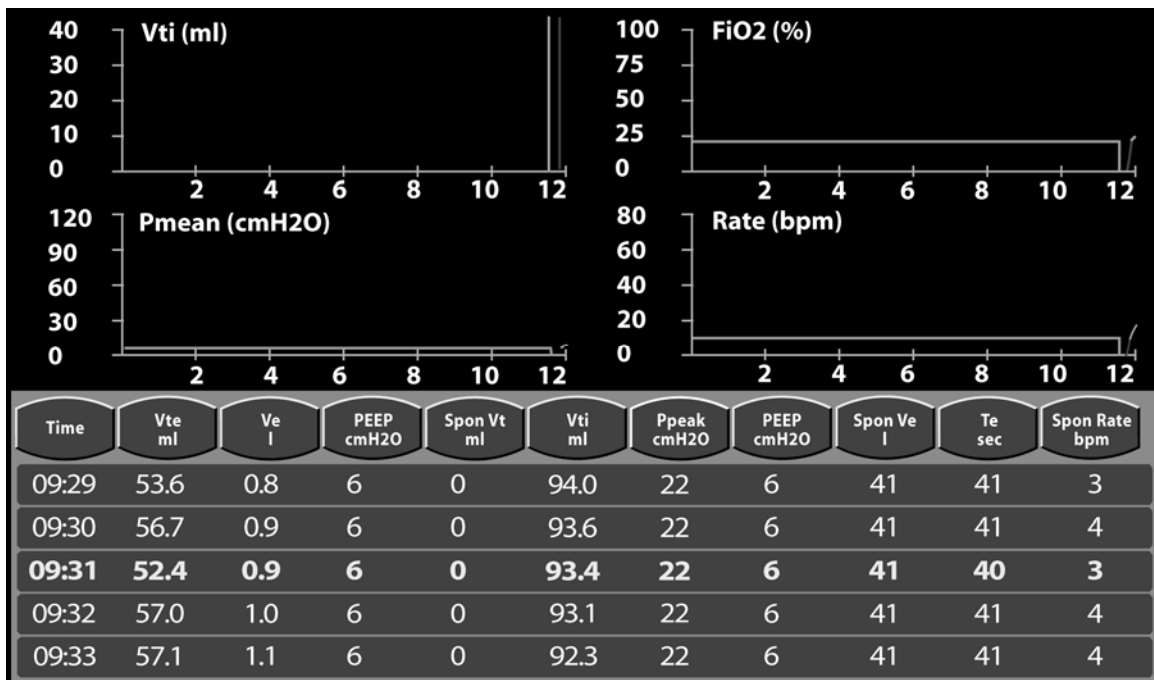

Figure 4.8 The Trends Screen

Four histograms and a spreadsheet are displayed on the touch screen. Each histogram and column on the spreadsheet can be configured from the 16 monitored parameters. Touch the title bar of any histogram or the heading of any column to open a scrollable menu. Move through the list by turning the data dial. Highlight the item to be displayed and press the highlighted display or the ACCEPT button above the data dial to accept the new item for display.

Histograms can be scaled. Touch either axis and with the axis highlighted, use the data dial to adjust the scale. Touch the axis again or press the ACCEPT button to accept the change.

To look at histogram or spreadsheet trends over time, press the FREEZE button and use the data dial to move the cursor through the time line. The time line is shown in yellow text on the spreadsheet.

The Trends screen updates every 10 minutes. While the screen is frozen, no updates occur until the screen is unfrozen. Trend data is stored every minute by the ventilator.

## *The Maneuvers Screen*

The following maneuvers are available with the Vela.

- MIP/NIF (Maneuver Screen) (Comprehensive model only)
- AUTOPEEP (Expiratory Hold)
- Static Compliance (Inspiratory Hold)

### **MIP/NIF**

MIP/NIF (Maximum Inspiratory Pressure or Negative Inspiratory Force) is accessed through the Screen Select Box.

1. Touch the screen indicator in the top center of the Main Screen display.
2. The Screen Select box displays, see figure 4.7.
3. Select MANEUVER from the selection box that appears.

The MIP/NIF button can be used to measure the patient's inspiratory effort. Press and hold this touch screen button and then encourage the patient to inhale as deeply as possible. This closes both the expiratory and inspiratory valves until the button is released or 30 seconds pass, whichever occurs first. The Message Bar in the lower left hand corner of the touch screen displays the starting pressure (Pstart, the airway pressure (Paw) and the Maximum Inspiratory Pressure (MIP), also known as Negative Inspiratory Force (NIF).

Pstart ----- Paw ----- MIP ----- cmH2O.

When the button is released, or 30 seconds pass, the ventilator resumes ventilation and the highest MIP value is displayed. This message remains until another message is displayed. It can be cleared by pressing the Accept Button.

### AUTOPEEP

AUTOPEEP is performed with the Expiratory Hold button. Press and hold this button to start the maneuver. At the end of the next expiratory time period, the inspiratory valve is closed for a maximum of 6 seconds. Successful completion of the AutoPEEP maneuver requires a passive patient. The message bar displays the following data:

Paw nn Pex mm AUTOPEEP xx cmH<sub>2</sub>O

Where nn is the baseline airway pressure at the beginning of the maneuver, mm is the ending exhalation pressure and xx is the measured AutoPEEP.

### Static Compliance

Static compliance is performed with the Inspiratory Hold button. Press and hold this button to start the maneuver. At the end of the next inspiratory period, the expiratory valve is closed for a maximum of 6 seconds. Successful completion of the static compliance maneuver requires a passive patient. The message bar first displays the current airway pressure as Paw xxx cmH<sub>2</sub>O. At the end of inspiration the message changes to display the plateau pressure as Pplat xxx cmH<sub>2</sub>O. When the button is released, or six seconds pass, the alveolar distending pressure and the static compliance is displayed as:

Palvd xxx cmH<sub>2</sub>O Cst xxx ml/cmH<sub>2</sub>O



# Chapter 5 Alarms and Indicators

## Status Indicators

The ventilator displays the following status indicators.

### *Mains/Battery Indicators*

These are visual status indicators on the bottom of the ventilator front panel for the mains power and the internal battery. Figure 5.1 shows the Battery Status display.

The sequence in which the power sources are used by the ventilator is:

- Mains AC
- Internal Battery

### Power On Indicator

The green **On** indicator lights up whenever the power switch is on ( I ) and power is being supplied from any of the available power sources (AC or internal battery).

### AC Power Indicator

The green **AC** indicator is on whenever AC power is applied to the ventilator. It displays whether the power switch is on ( I ) or off ( O ).

### Internal Battery Indicator

The green **Battery** indicator is lit whenever the internal battery is providing the primary source of power for the ventilator.

### Battery Status Indicators

The DC **Status** indicator shown in figure 5.1 for the internal battery illuminates in a different color depending on the available charge remaining in the battery.

---

## *Note*

*If the ventilator is plugged into the mains power supply and no battery status light is lit, the battery should be checked and/or replaced. Replacement of the internal battery must be done by a VIASYS trained technician.*

---

- Green (full charge),
- Yellow (less than 40%)
- Red (less than 20%)

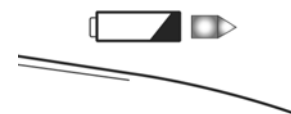

Figure 5.1 Battery Status LED

### **Audible Battery Status Alarms**

When the battery charge falls below 40% and the LED status indicator shown in figure 5.1 turns yellow a continuous tone alarm sounds. This alarm can be silenced temporarily by pressing the alarm silence membrane button. The alarm can be cleared by pressing the alarm reset button twice.

If the battery charge falls below 20% and the LED status indicator shows red, an intermittent tone sounds. This audible alarm can be silenced by pressing the silence button but re-occurs in 60 seconds if an alternate power source is not found.

### **Alarm Categories**

Vela ventilator alarms are grouped into three categories:

- High priority (warning), requires immediate action.
- Medium priority (caution),
- Low priority (advisory).

Depending on their category, alarms have different visual indicators.

### **Visual Alarm Displays**

There is a visual display for all categories of alarm whenever the alarm condition is active. A message appears in the bar at the upper right of the touch screen.

For a high priority alarm, the status bar is RED and flashes at a rate of 2 Hz (fast). A medium priority alarm displays a yellow status bar and flashes at ½ Hz (slow). A low priority alarm (or advisory) displays a yellow colored status bar and does not flash. The alarm indicator is solid green with no message when no alarms are current.

For flashing alarms, the message flashes until the cause of the alarm is no longer present. Both high and medium priority alarms that have been resolved appear as a solid yellow non-flashing bar until the alarm Reset button is pressed. See table 5.1 for alarm messages.

Multiple alarms can display together. If only one alarm is current, it appears alone in the alarm indicator. If 2 or more alarms are present, an arrow appears on the right of the alarm indicator and a drop down box is enabled. You can activate the drop down box by touching the arrow, and deactivate it by touching the arrow again. The box is able to display up to nine total alarm messages.

If multiple alarms are current, the alarm messages are prioritized with the highest priority at the top and the lowest priority at the bottom. If more than nine alarms are current, only the nine highest priority alarms are displayed.

### **Audible Alarms**

A continuous tone sounds during high and medium priority alarms. There is no audible component for low priority alarms.

## Alarm Controls

### Setting Alarm Limits

To set the limits for each alarm, touch the red Alarm LIMITS button on the bottom of the touch screen.

The Alarm Limits screen appears (see figure 5.2). To set the limits for an alarm, select it by touching the touch screen immediately over the alarm control. The control highlights (changes color) on the screen. With the control selected, rotate the data dial below the front panel until the control reaches the setting you require. To accept the new setting, either touch the screen over the control again or press the ACCEPT button.

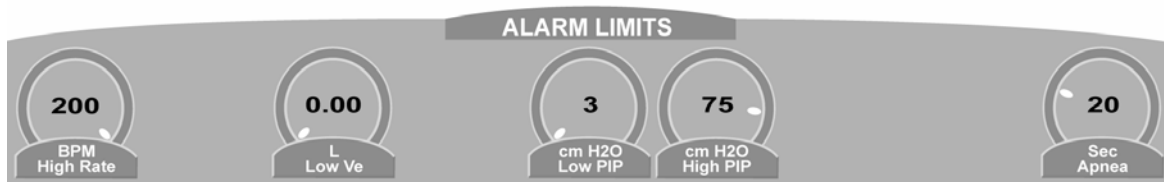

Figure 5.2 Alarm Limits Screen

### Alarm Silence

You can disable the audible alarm for 60 seconds by pressing the Alarm Silence button. Pressing the alarm silence button again before the 60 second period is complete restarts the alarm. This feature is functional for all alarms, with the exception of the “Vent Inop” alarm, which cannot be silenced.

### Alarm Reset

The alarm reset button clears visual indicators for alarms that are no longer active.

## Alarm Types

### Machine Alarms

#### Low Battery

This is a medium priority audible/visual alarm at 40% of battery charge. It changes to a high priority audible/visual alarm when the battery charge drops below 20%. **LOW BATTERY** is displayed in the alarm message window.

#### Ventilator Inoperative

This is high priority audible/visual alarm. **VENT INOP** is displayed if the ventilator fails due to a non-recoverable condition, such as loss of power. The safety valve opens and the patient is allowed to breathe room air.

---

### Note

*PEEP is not maintained during a VENT INOP alarm condition.*

---

## Fan Failure

This is a low priority audible/visual alarm. **FAN FAILURE** is displayed whenever the fan stops rotating.

### Transducer Fault (XDCR FAULT)

This is a medium priority audible and visual alarm. XDCR FAULT occurs when a transducer's zero point has drifted out of range. If the alarm does not clear by pressing the reset button twice, replace the exhalation valve body and reseal the diaphragm. If this condition continues, remove the ventilator from service and contact your Viasys Certified Service Technician.

### Default Settings (DEFAULTS)

This is a medium priority audible and visual alarm. The ventilator is shipped from the factory with built-in default settings for all operational parameters. Once the user sets a front panel control, the corresponding default value for that control is overridden by the new setting. The new setting is then stored in the ventilator so that it can be retained even when the ventilator is turned OFF. When the ventilator is turned ON, the retained settings are automatically restored. If something happens that prevents the ventilator from retrieving these retained settings, the ventilator restores the original factory default settings, allowing the ventilator to continue to operate safely. This alarm notifies you that the ventilator is operating at the default settings. The alarm is cleared by pressing the reset button twice and setting the controls to the desired settings. If this alarm occurs frequently, contact your Viasys Certified Service Technician.

## *Gas Supply Indicators and Alarms*

### Loss of High Pressure O<sub>2</sub> Source

This is a high priority audible/visual alarm. **O<sub>2</sub> Inlet LOW** is displayed. This alarm is triggered if the high pressure oxygen supply to the ventilator drops below 38 psig (2.62 bar) and the % O<sub>2</sub> control is set >21%. The patient continues to be ventilated on room air (21% O<sub>2</sub>) only.

## *Pressure Alarms*

### Low Peak Pressure

This is a high priority audible/visual alarm. **LOW PIP** is displayed whenever the peak inspiratory pressure for a given breath is less than the preset threshold for LOW P<sub>PEAK</sub>.

Range: Off, 2 to 60 cmH<sub>2</sub>O

Default: 3 cm H<sub>2</sub>O

Limitations: Not active for spontaneous breaths.

### High Peak Pressure

This is a high priority audible/visual alarm. **HIGH PIP** is displayed whenever the preset High P<sub>PEAK</sub> threshold is exceeded. Inspiration is terminated and circuit pressure is allowed to return to the current set baseline pressure + 5 cmH<sub>2</sub>O. Circuit pressure must return to baseline + 5 cmH<sub>2</sub>O before the next breath can be delivered.

- **Normal High P<sub>PEAK</sub> Alarm**

Alarms if the inspiratory pressure in the patient circuit exceeds the set High P<sub>PEAK</sub> alarm threshold during the inspiratory phase of a breath, except during sigh breath cycles.

Range: 5 to 120 cmH<sub>2</sub>O

Defaults: 40 cmH<sub>2</sub>O

Not active for Sigh Breaths

- **Sigh High P<sub>PEAK</sub> Alarm**

Alarms if the inspiratory pressure in the patient circuit exceeds the Sigh High P<sub>PEAK</sub> alarm threshold during a sigh breath cycle.

Range: 1.5 x (Normal High P<sub>PEAK</sub>), up to a maximum of 120 cmH<sub>2</sub>O

Active only for Sigh Breaths.

### High PEEP

This is a high priority audible/visual alarm. **HIGH PEEP** is displayed if the baseline pressure (PEEP) does not return to the set PEEP + 15 cmH<sub>2</sub>O during exhalation. The alarm automatically clears once the pressure returns to within 15 cmH<sub>2</sub>O.

---

## Note

### *Maximum Circuit Pressure Limit:*

*The ventilator has an independent adjustable mechanical pressure relief valve, which limits the maximum pressure at the wye from 20 to 130 cmH<sub>2</sub>O. See Operational Verification Testing / Manual Verification Tests for specific instructions on setting the pressure relief valve.*

---

## Volume Alarms

### Low Exhaled Minute Volume (Low V<sub>e</sub>)

This is a medium priority audible/visual alarm. **LOW MINUTE VOLUME** is displayed whenever the monitored exhaled minute volume is less than the Low Exhaled Minute Volume threshold setting.

Range: Off, 0.1 to 99.9 L

Default: 0.1

## Rate/Time Alarms

### Apnea Interval (Apnea)

This is a high priority audible/visual alarm. **APNEA** is displayed if the ventilator does not detect a breath initiation (by any means) within the preset period of time.

Range: 10 to 60 seconds

Default: 20 seconds

### High Rate

This is a medium priority audible/visual alarm. **HIGH RATE** is displayed if the monitored total breath rate exceeds the alarm setting.

Range: 3 to 150 bpm, Off

Default: 75

## O<sub>2</sub> Alarms

### CHK O<sub>2</sub> CAL

This is a high priority audible and visual alarm. CHK O<sub>2</sub> CAL is displayed if the monitored Delivered O<sub>2</sub>% is outside the range of the set FIO<sub>2</sub>. If the O<sub>2</sub> setting is 21-60, the alarm activates with 6% deviation; 61-80% set O<sub>2</sub>, the alarm activates with a 7% deviation and with set values of 81-100%, the alarm activates with an 8% deviation.

FIO <sub>2</sub> Set	Percent Deviation to Activate CHK O <sub>2</sub> CAL Alarm
.21- .60	6%
.61- 80	7%
.81- 1.0	8%

### O<sub>2</sub> RANGE ERROR

This is a high priority audible and visual alarm that is activated when the CHK O<sub>2</sub> CAL is activated, the

CHK O<sub>2</sub> CAL alarm has not been corrected and the monitored delivered O<sub>2</sub> is outside the range of the

set FIO<sub>2</sub> by an additional 4%.

FIO <sub>2</sub> Set	Percent Deviation to Activate O <sub>2</sub> RANGE ERROR alarm
.21- .60	10%
.61 - .80	11%
.81 – 1.0	12%

### Circuit Fault

This is a high priority audible and visual alarm. Circuit Fault is displayed if the inspiration pressure exceeds the High Pressure Limit plus an offset, which is determined by the amount of inspiratory flow. This condition occurs when the breathing circuit tubing is disconnected or occluded.

---

### Note

*Circuit Fault Alarm can appear when a mask is not fitted well to the patient's face during non-invasive ventilation. Improving the mask fit will eliminate this alarm.*

---

Table 5.1 Alarm Conditions

Message	Alarm Condition	Range	Priority
LOW BATTERY	Battery charge has fallen below 40% (medium priority alarm) or 20% (high priority alarm)	N/A	Medium/High
SAFETY VALVE	Safety valve is open	N/A	High
VENT INOP	Ventilator failure due to non-recoverable condition. The safety valve opens and the patient is allowed to breathe room air. PEEP is not maintained	N/A	High
O <sub>2</sub> Inlet Low	Oxygen supply to the ventilator drops below 35.0 psig (2.62 bar) and the %O <sub>2</sub> is set to > 21%. Patient continues to be ventilated with room air only	N/A	High
LOW PIP	The peak inspiratory pressure for a breath is less than the set LOW P <sub>PEAK</sub> . Not active for spontaneous breaths.	Off, 2 to 60 cmH <sub>2</sub> O Default 3 cmH <sub>2</sub> O	High
HIGH PIP	Peak inspiratory pressure is greater than the set HIGH P <sub>PEAK</sub> . Inspiration is terminated and the circuit pressure allowed to return to baseline pressure ± 5 cmH <sub>2</sub> O before the next breath is delivered.	Normal Breath Range: 5 to 120 cmH <sub>2</sub> O default 40 cmH <sub>2</sub> O  Sigh Breath Range: 1.5 x set normal HIGH P <sub>PEAK</sub> Only active for sigh breaths	High
High PEEP	Baseline pressure (Positive End Expiratory Pressure) does not return to PEEP + 15 cmH <sub>2</sub> O during exhalation. Automatically clears when pressure returns to within 15 cmH <sub>2</sub> O of PEEP.	Automatic	High
LOW MINUTE VOLUME	Monitored exhaled minute volume (V <sub>e</sub> ) is less than the set LOW V <sub>e</sub> alarm threshold.	OFF (0), 0.1 to 99.9 L Default 0.1	Medium
APNEA	Active in CPAP and SIMV modes. The ventilator does not detect a breath within the preset APNEA time interval.	10 to 60 sec Default 20 sec	High
HIGH RATE	The monitored total breath rate exceeds the set alarm RATE.	OFF, 3 to 150 bpm Default 75 bpm	Medium
CHK O <sub>2</sub> CAL	Delivered oxygen percentage differs from the set FiO <sub>2</sub> by 6 - 8%.	N/A	High
O <sub>2</sub> RANGE ERROR	Delivered oxygen percentage differs from the set FiO <sub>2</sub> by 10 – 12% for longer than 20 seconds.	The alarm is disabled for 180 seconds when the 100 %O <sub>2</sub> button is pressed	High
Circuit Fault	This occurs when the patient circuit is occluded or open because of a gross disconnection of the patient tubing from the patient, humidifier or ventilator.	Insp pressure must exceed expiratory pressure by an amount which increases proportionally with increasing inspiratory flow.	High

This page intentionally left blank.



# Chapter 6 Maintenance and Cleaning

## Cleaning & Sterilization

The Vela is designed for easy maintenance. All exposed parts of the ventilator are corrosion resistant. To prevent pooling of liquids, there are no flat surfaces on the ventilator body.

### CAUTION

DO NOT submerge the ventilator or pour cleaning liquids over, into or onto the ventilator.

## Cleaning

### *Cleaning of External Surfaces*

All external surfaces of the ventilator can be wiped clean with a soft cloth using Isopropyl Alcohol

### *Cleaning of Accessories and Ventilator Parts*

#### Accessories

The following accessories can be cleaned using Klenzyme® :

- The exhalation valve body
- The exhalation flow sensor.
- The exhalation diaphragm

### *Cleaning Method for the Exhalation Valve Assembly*

#### Remove the Exhalation Valve Assembly for Cleaning

1. Press and hold the release latch on the lower left of the exhalation valve housing.
2. Grasp the exhalation valve body, rotate it counter-clockwise until the alignment slots line up, and then gently pull it free from the housing.
3. Grasp the exhalation valve diaphragm by the center and remove it from the exhalation valve body.
4. Using a clean soft cloth and Isopropyl Alcohol, wipe all exposed surfaces around the exhalation valve housing. Do not allow cleaning fluid to spill into the opening in the exhalation valve housing.

#### To Clean the Exhalation Valve Body, Flow Sensor and Diaphragm:

1. Soak in Klenzyme solution for 5 minutes. Klenzyme bath may be heated to a maximum of 67 °C (152 °F).
2. Rinse in distilled water. After cleaning the surfaces, make sure all excess cleaning solution is completely removed to prevent residue buildup. Dry with a soft cloth or allow to air dry.

## Sterilization

The following accessory parts can be sterilized:

- The exhalation valve body
- The exhalation flow sensor
- The exhalation diaphragm

### *Method of Sterilization*

The preferred method of sterilization is

Steam Sterilization (autoclave), minimum 132° C (270° F) maximum temperature 134 °C (273 °F). It is recommended that the accessories listed above be replaced after 30 cleaning and sterilization cycles.

1. After cleaning the surfaces, make sure all excess cleaning solution is completely removed to prevent residue buildup.
2. Sterilize the exhalation valve body, flow sensor and diaphragm using steam autoclaving within the guidelines stated above.
3. Using a low flow gas source (less than 10 L/min) ensure the differential pressure tubes are free of moisture and debris.
4. To avoid possible damage to elastomeric components, the peak temperature for VIASYS Respiratory Care accessories should not exceed 275 °F (135 °C) for steam autoclave.
5. Steam autoclave at 0 gravity cycle time is 15 minutes. At HiVac (20 psi) cycle time is 7 minutes and drying time is 10 minutes.
6. Ultrasonic cleaning is not recommended. Liquid sterilizing agents containing more than 2% glutaraldehyde are also not recommended. If such agents must be used, be sure to thoroughly rinse and dry the assembly to prevent residue buildup. Residue buildup in the differential pressure ports can cause inaccurate pressure and volume readings.
7. Prior to replacing the exhalation valve diaphragm, inspect it for excessive wear. If signs of damage are found, obtain a new diaphragm.
8. Insert the diaphragm. Hold it by the center and set it into the exhalation valve-housing receptacle. Gently tap around the perimeter until the diaphragm is firmly seated.
9. Line up the tabs of the exhalation valve body with the alignment slots on the exhalation valve housing. Gently push the exhalation valve body into place and rotate it clockwise until the release latch pops out. The exhalation valve body 'clicks' into place.
10. Gently pull on the exhalation valve body to make sure it is securely attached to the ventilator.

## Other Accessories

For all other accessories purchased for use with your Vela Ventilator, but not supplied by VIASYS Respiratory Care, follow the manufacturer's recommendations for cleaning or sterilization.

## Recommended Periodic Maintenance

VIASYS Respiratory Care is committed to product support. If you have any questions concerning your ventilator's operation or maintenance contact your product support representative as shown in Appendix A, Contact Information.

Every 500 hours, the air intake filter should be checked and cleaned if necessary. A reminder message is displayed on the front panel at 500 hour increments. To clear this message press the Accept Key. To clean the filter, remove it from its recess and immerse in warm soapy water. Rinse thoroughly and dry thoroughly before replacing in the ventilator.

Preventive maintenance should be performed on your Vela ventilator every 5,000 hours. Call the applicable number given in Appendix A to arrange for a qualified service technician to perform this.

### WARNING

Electric shock hazard - Do not remove any of the ventilator covers or panels. Refer *all* servicing to an authorized VIASYS Respiratory Care service technician.

The 5,000 hour maintenance includes the following.

Replacement of:

- The Rear Air Inlet Filter
- The Oxygen Inlet Filter
- The Turbine Muffler Filter Cores and O-rings
- The Fan Filter

At this time the following maintenance is performed:

- Removal & replacement of the above items
- Calibration
- Verification Testing to confirm the ventilator is functioning within optimum parameters.

---

### Note

*Battery performance checks should be performed as outlined in the Vela Service Manual. In addition to the battery-test procedures, VIASYS recommends that the internal batteries be replaced every 10,000 hours, or every two years.*

---

### Note

*Vela Maintenance should only be performed by a trained and authorized service technician. VIASYS Respiratory Care will make available to qualified technicians, service manuals, which include such items as circuit diagrams, component parts lists, calibration instructions and other information to assist in repair of those parts of the ventilator designated by the manufacturer as repairable items.*

## Operational Verification Tests

Perform the Operational Verification Tests (described in Chapter 2) at the following times:

- before connecting the ventilator to a new patient,
- as specified by your department guidelines,
- any time you suspect the ventilator is not operating properly.

### WARNING

If a mechanical or electrical problem is recognized while running the Verification Tests, or while operating the ventilator, the ventilator must be removed from use and referred to qualified personnel for servicing.

Using an inoperative ventilator may result in patient injury.

## Battery Care

The Vela has an internal, Nickel Metal Hydride battery pack that provides power backup for short periods in the event that the mains power supply is lost. The standard internal battery pack provides about six (6) hours of operation under moderate settings when fully charged and in good operating condition. The condition of the battery and condition of the charge may not always be optimal. Therefore, it is prudent to expect 4 to 4.5 hours of reliable battery backup.

### Note

*VIASYS Critical Care recommends that when the ventilator is used in a transport situation, the expected transport time should not be greater than 50% of the usable battery life. This provides a safety margin in the event of schedule delays or premature consumption of the battery power. Should the expected transport time be delayed beyond this, a dedicated transport system should be considered. As with any patient transport, suitable manual ventilation backup should be available.*

Whenever the ventilator is connected to an appropriate AC voltage source, the batteries receive a trickle charge. Do not allow your battery to become completely discharged as this may damage the ventilator. To ensure that the batteries remain charged and to prolong their life, we recommend that you keep the ventilator plugged in to the AC power supply when not in use. The Battery Status Indicators on the front panel enable you to monitor the available charge remaining in your battery. (See Chapter, 5 Alarms and Indicators, for details of the "Low Battery" alarm).

### Precedence of use

The sequence in which the power sources are used by the ventilator is:

1. AC
2. Internal Battery

**CAUTION**

Do not store the ventilator in hot areas for prolonged periods of time. Temperatures above 80°F (27°C) can shorten battery life.

Failing to charge the ventilator while in storage may also shorten battery life. High rates, pressurized flow can also reduce total battery backup time.

**CAUTION**

When the integrity of the external power earth conductor arrangement is in doubt, operate the ventilator from its internal battery.

### *Battery Status Indicators*

Battery status indicators showing the state of charge of the internal batteries appear on the front panel of the ventilator.

The DC **Status** indicator shown in figure 5.1 for the Internal battery illuminates in a different color depending on the available charge remaining in the battery.

---

### *Note*

*If the ventilator is plugged in to the mains power supply and no battery status light is lit, the battery should be checked and/or replaced. Replacement of the Internal battery must be done by a VIASYS trained technician.*

---

- Green (full charge),
- Yellow (Less than 40%)
- Red (less than 20%)

**CAUTION**

A battery that is fully drained (i.e. void of any charge) may cause damage to the ventilator and should be replaced.

### **Audible Battery Status Alarms**

When the battery charge falls below 40% and the LED status indicator shown in figure 5.1 turns yellow and a continuous tone alarm sounds. This alarm can be silenced temporarily by pressing the alarm silence membrane button. The alarm can be cleared by pressing the alarm reset button twice.

If the battery charge falls below 20% and the LED status indicator shows red, an intermittent tone sounds. This audible alarm can be silenced by pressing the silence button but re-occurs in 60 seconds if an alternate power source is not found.

### **Failure to charge**

If the internal batteries do not show significant re-charge after being connected to an AC power source for 8 hours, contact your VIASYS Respiratory Care as shown in Appendix A to arrange for replacement. Total time to re-charge depends upon the extent of battery depletion and ventilator usage while charging is taking place.

## Fuses

The Vela has the following replaceable fuses associated with internal power sources.

### WARNING

Do not remove or replace fuses or perform any maintenance tasks on the ventilator while your patient is connected. **Always perform these tasks "off patient"**.

### *Battery Fuses*

The internal battery fuses are 5A, 250V 5 x 20mm slow blow type. The internal battery fuse should only be replaced by a trained, authorized VIASYS Respiratory Care technician.

### CAUTION

To avoid fire hazard, use only the fuse specified in the ventilator's parts list or one that is identical in type, voltage rating, and current rating to the existing fuse. Internal fuses should only be changed by a trained authorized technician.

### *Mains AC Fuses*

The AC power fuses are housed within the power entry module located on the back panel. They are slow blow-type. Check that the correct voltage for your mains supply is showing through the window in the power entry module.

**Table 6.1 Mains fuses**

Line Voltage	Fuse	Amperage	Type
90-264 VAC	250V 5 x 20mm	3.1A	S

## Changing the AC Fuses:

### WARNING

Ensure that the mains power cord is unplugged from the main AC outlet before attempting to remove or replaces fuses.

To replace the mains (AC) electrical fuses, refer to figures 6.1 to 6.3 and do the following:

Remove the power cord protective cover.  
Unplug the A/C power cord.

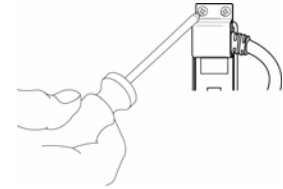

**Figure 6.1 Remove the power cord guard**

The AC power module is a universal module for A/C voltages from 100-240 volts. Using a flat bladed screwdriver, lift open the cover. Using the same screwdriver, loosen and pull out the red fuse holder as shown in figure 6.2.

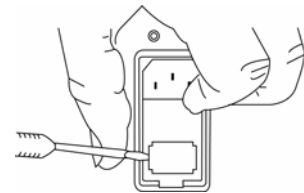

**Figure 6.2 Pry out the fuse holder**

Remove the fuses from both sides of the fuse holder and replace with fuses P/N 71612 (available from VIASYS Respiratory Care customer support).

### WARNING

It is important that the fuses are replaced with the same type and value as those removed. Failure to do so can result in ventilator malfunction.

For use with 100 to 120 volts, make sure the 4 metal tabs are facing up as shown in figure 6.3 and carefully push the fuse holder in to the A/C power module until it seats. Close the cover and check that "115V" is visible in the red window.

For use with 200 to 240 volts, make sure the 4 metal tabs are facing *down* and carefully push the fuse holder in to the A/C power module unit until it seats. Close the cover and check that "230V" is visible in the red window.

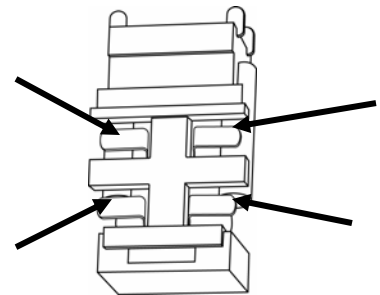

**Figure 6.3 Fuse holder with metal tabs upward**

This page intentionally left blank.



# Appendix A Contact & Ordering Information

## How to Call for Service

To get help with any of the preventive maintenance routines, or to request service for your ventilator, contact VIASYS Respiratory Care at the following numbers:

### Technical and Clinical Support

Hours: 6:30 AM to 4:30 PM (Pacific Time) Monday through Friday  
Phone: (800) 231-2466 (From within the U.S. only) or (714) 283-2228  
Fax: (714) 283- 8471

After-hours service:

Phone: (800)231-2466 (From within the U.S. only)  
Fax: (714) 283-8473 or (714) 283-8419

To obtain Vela Ventilator parts contact customer service at:

Hours: 7:00 Am to 4:30 PM (Pacific Time)  
Monday through Friday  
Phone: (800) 328-4139 (From within the U.S. only)  
(714) 283-2228  
Fax: (714) 283-8473 or (714) 283-8419

Online service for warranty replacements parts can be found at  
[www.viasyshealthcare.com/bird](http://www.viasyshealthcare.com/bird)

Select "Warranty Form" from the choices on the left of the screen.

### VIASYS Healthcare Customer Care Help line

Hours: 24 hours, seven days a week  
Phone: From within the U.S. only: (800) 934-2473 or (800) 231-2466 or (800) 520-4368  
Fax: (714) 283-8473 or (714) 283-8419  
Email: support.vent.us@viasyshc.com

Parts which can be ordered from VIASYS are:

VIASYS Part No.	Description
00423	22mm I.D. Cuff Adapter
04124	Tapered Plug, 7.5mm Male
04709	90 Degree Elbow Adapter
20225	Wye Connector
09413	Water Trap, Natural, Autoclavable
09531	Circuit Tubing, 30" (76.2 cm) Smooth Bore
16240	Exhalation Valve Diaphragm
10472	15' (3 m) high pressure oxygen hose
20005	Exhalation Valve Body
16496	Variable Orifice Flow Sensor
L1536	Users Guide English
L2854-101	Operator's Manual English
L2854-102	Operator's Manual German
L2854-103	Operator's Manual French
L2854-104	Operator's Manual Italian
L2854-105	Operator's Manual Spanish
L2854-106	Operator's Manual Portuguese
L2854-107	Operator's Manual Japanese
L2854-118	Operator's Manual Russian
L2854-119	Operator's Manual, Hungarian
L1536-102	User's Guide, German
L1536-103	User's Guide, French
L1536-104	User's Guide, Italian
L1536-105	User's Guide, Spanish
L1536-107	User's Guide, Japanese
L1536-118	User's Guide, Russian
L1536-119	User's Guide, Hungarian
L2864	Operator's Manual on CD.

# Appendix B Specifications

## Oxygen Supply

### *High Pressure Connector*

Pressure Range:	40 to 85 psig (2.76 to 5.86 bar)	(Supply Oxygen)
Temperature:	10 to 40 °C (50 to 104 °F)	
Humidity:	Dew Point of gas should be 1.7 °C (3 °F) below the ambient temperature (minimum)	
Minimum Flow:	80 L/min at 20 psig (1.38 bar)	
Inlet Fitting:	CGA DISS-type body, No. 1240	

### *Low Pressure Connector*

Pressure Range:	0 to 0.5 psig (0.0345)	(Supply Oxygen)
Maximum Flow:	80 L/min	
Inlet Fitting:	¼ inch (5.14 mm) tapered	

## Electrical Supply

### *AC Power Supply*

The ventilator operates within specification when connected to the following AC power supplies:

Voltage Range	Frequency Range
(90 to 264 VAC)	47 to 65 Hz

### *DC Power Supply*

The ventilator can also operate from a 48 VDC power source (internal battery).

#### **Internal Battery:**

The ventilator operates within specification for approximately 6 hours with a fresh, fully charged battery under moderate load. Maximum charge time for a full charge is 8 to 12 hours.

## Data Output

### **WARNING**

The Vela is designed to ensure that the user and patient are not exposed to excessive leakage current per applicable standards (UL2601 and IEC60601-1). However, this cannot be guaranteed when external devices are attached to the ventilator.

To prevent the risk of excessive enclosure leakage current from external equipment attached to the printer or video ports, the protective earth paths must be isolated to ensure proper connection.

This isolation should ensure that the cable shields are isolated at the peripheral end of the cable.

### *Remote Nurse Call*

The ventilator has a modular jack configured to interface with external systems that are either wired for normally closed (NC, open on alarm) with the use of cable part # 15620, or normally open (NO close on alarm) signals with the use of cable part # 15619.

### *Fiber-optic Output*

The ventilator provides a fiber-optic output connector, which allows for interfacing to an external patient monitor.

### *Printer*

The ventilator has a standard 25-pin female Centronics parallel printer port on the rear panel which interfaces to an HP 940C printer.

### *Video Output*

The ventilator provides a video output connector, which allows for interfacing to an externally located 256-color, 800 x 600, SVGA monitor.

## Atmospheric & Environmental Specifications

### *Temperature and Humidity*

#### Storage

Temperature: -20 to 60 °C (-4 to 140 °F)

Humidity: 10 to 95% RH non-condensing

#### Operating

Temperature 5 to 40 °C (41 to 104 °F)

Humidity 15 to 95% RH non-condensing

### *Barometric Pressure*

760 to 545 mmHg

## Physical Dimensions

### *Overall Size*

13" W x 14.5" D x 12" H or 33.0cm X 36.8cm X 30.5cm

### *Weight*

38 lbs. (17.3 kg)

This page intentionally left blank.

## Appendix C Low Flow Oxygen Chart

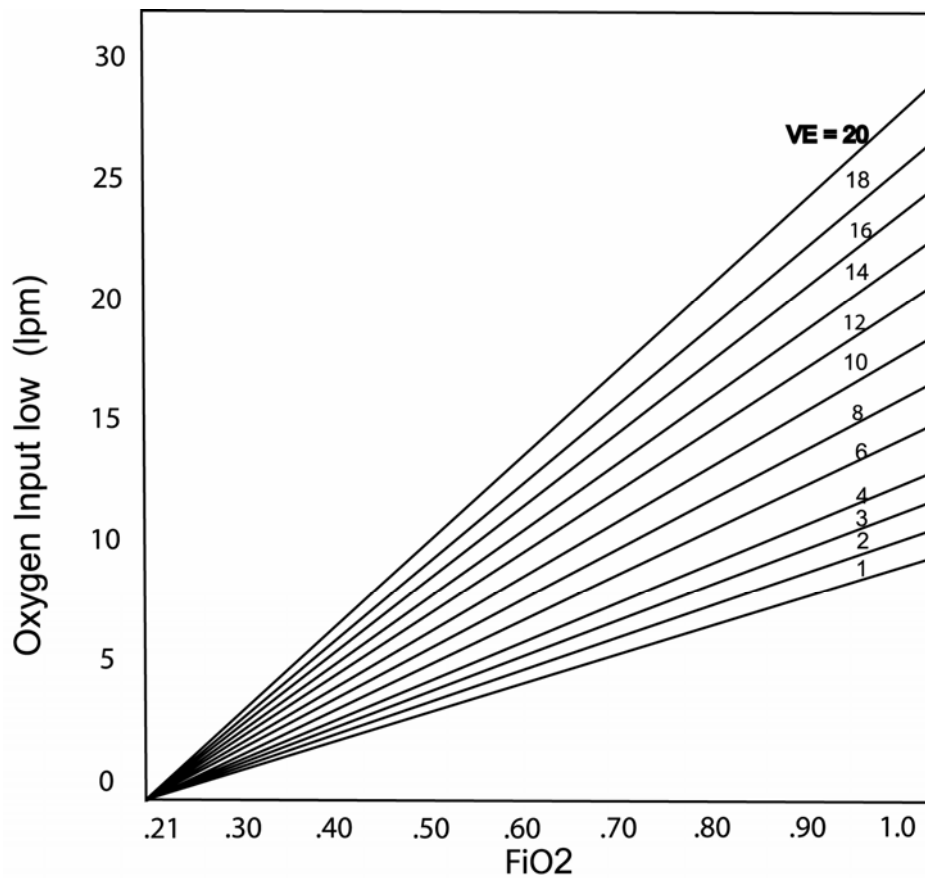

Figure C-1. Low Flow Oxygen Chart

### To Find O<sub>2</sub> Input Flow

1. Select desired FiO<sub>2</sub> on horizontal axis.
2. Project up to current minute volume (VE from monitor display).
3. Project horizontally to left vertical axis and read oxygen flow.

### To Find O<sub>2</sub> Concentration

1. Select current O<sub>2</sub> input flow on vertical axis.
2. Project horizontally right to current minute volume (VE from monitor display).
3. Project vertically down to horizontal axis and read oxygen concentration

This page intentionally left blank.



# Glossary

Breath Interval	Elapsed time from the start of one breath to the start of the next.
Preset	An operator set ventilator parameter.
Trigger	Value at which the ventilator initiates delivery of a breath as a result of measured patient effort.
BTPS	Body Temperature at Ambient Pressure, Saturated.
ATPD	Ambient Temperature, Ambient Pressure, Dry.
Demand Flow	The flow generated by the ventilator to meet the patient's flow demand in order to maintain PEEP at the preset level.
AC	Alternating Current (mains electricity).
Bias Flow	A continuous flow through the patient breathing circuit.
bpm	Breaths per minute.
Breath Period	The length of time between machine-initiated breaths. Depends on the Breath Rate setting.
Breath Rate	The number of breaths delivered in a minute.
BTPD	Body Temperature at Ambient Pressure, Dry
Button	A push button switch used to toggle a function on or off.
cmH <sub>2</sub> O	Centimeters of water pressure.
Controls	Any button, switch, or knob that allows you to modify the ventilator's behavior.
Event	An anomalous condition that occurs during ventilator operation.
Flow	The rate at which gas is delivered. Measured in liters per minute (L/min).
Indicators	A visual element showing operational status.
L	Liters. A unit of volume.
LED	Light Emitting Diode
L/min	Liters per minute. A unit of flow.
Mode	An operating state of the ventilator that determines the allowable breath types.
Monitored Parameter	A measured value displayed in the monitor window.
O <sub>2</sub>	Oxygen
Patient Breathing Circuit	The tubing that provides the ventilatory interface between the patient and ventilator.
Paw	Airway Pressure. Measured in cmH <sub>2</sub> O at the exhalation valve.
PEEP	Positive End Expiratory Pressure.

P <sub>peak</sub>	Peak Inspiratory Pressure. Shows the highest circuit pressure to occur during inspiration as measured at the exhalation valve. The display is updated at the end of inspiration. P <sub>peak</sub> is not updated for spontaneous breaths.
P <sub>plat</sub>	Plateau Pressure. Measured during an Inspiratory Hold maneuver. Used to calculate Static Compliance. (C <sub>st</sub> ).
psig	Pounds per square inch gauge. 1 psig = .07bar
Sigh Breath	A Volume Controlled machine breath having a tidal volume equal to one-and-a-half times (150% of) the current tidal volume setting.
User Verification Tests (UVT)	A group of tests to check ventilator performance prior to connecting the ventilator to a patient.
WOB	Patient Work of Breathing i.e. a measure of Patient Effort.

# Index

## A

- AC power, 23
- AC power module, 77
- accept data, 30
- accessories, 72
- activate a primary breath control, 46
- advanced settings, 49
  - assured volume, 51
  - Vsync, 52
- alarm conditions, 69
- alarm reset button, 65
- alarm silence, 4
- alarm silence button, 65
- alarm types, 65
- alarm volume, 4
- alarm window, 23
- alarms
  - gas supply, 66
  - machine, 66
  - pressure, 66
  - rate and time, 67
  - volume, 67
- alarms check, 23
- apnea backup, 35, 40
  - breath rate, 35
- apnea interval, 4
- assembly instructions
  - stand, 8
- assist control ventilation, 38
- assist/control, 1
- assured vol**, 51
- audible alarm, 20, 23, 64, 65, 75
- audible alarms, 64
- autopeep, 62
- available charge remaining in the battery, 63
- available power sources, 63

## B

- baseline airway pressure at the beginning of the maneuver, 62
- basic breath types, 36
- batteries
  - time to re-charge, 75
- battery, 1
  - external, 1
  - internal, 1
- battery charge, 64, 75
- battery power, 23
- battery status, 75
- bias flow, 3, 53
- breath interval, 28, 38, 39, 46
- breath rate, 3, 4, 23
- breath rate control, 46
- breathing circuit, xii, xiii, 21

- breathing circuit characteristics, 5

## C

- cancel data, 30
- cautions, *xiv*
- check the audible alarm, 20
- choice of waveforms, 55
- cleaning
  - accessories, 71
  - exhalation valve assembly, 71
  - external surfaces, 71
- cleaning agent, *xv*
- controls associated with each breath type & mode, 50
- CPAP, 1, 3
- CPAP/PSV mode, 40
- customer service, 79

## D

- data dial, 58
- default waveform, 52
- default settings, 32
- default waveform, 52
- diaphragm, 8, 25, 71, 72
- disable front panel controls, 30
- display, 85
- displayed graphs, 56

## E

- electrostatic shock, *xiv*
- exhalation valve, *xiii*, *xv*, 8, 9, 71, 72, 87, 88
  - attaching, 8
- expiratory hold, 28
- expiratory time, 4
- extended functions, 16
- external battery, 7, 23

## F

- fan inlet filter, *xv*
- features, 1
- FiO<sub>2</sub>, *xiii*, 85
- FiO<sub>2</sub> during nebulization, 29
- FiO<sub>2</sub> monitor calibration, 22
- flow at which the breath is delivered, 47
- flow cycle**, 51
- flow delivery system, 6
- flow sensor, *xv*, 71, 72
  - attaching, 9
- flow sensor connector, 9
- flow-volume loop, 56
- four breath variables, 36
- freeze, 28
- front panel LEDs, 19

fuses, 76, 77  
replacing, 77

**G**

gas supply alarms, 66  
graphics display, 1, 57

**H**

high pressure, *xiii*, *xv*, 23  
**high pressure limit**, 23  
highest priority alarms, 64  
high-pressure oxygen, 13  
HME, 10  
horizontal axis, 56  
humidification, 32

**I**

in-line nebulizer, 10, 29  
inspiratory flow, 47  
inspiratory hold, 3, 28  
inspiratory pause, 47  
inspiratory pressure, 46  
inspiratory time, 3, 4, 23, 47  
inspiratory trigger mechanism, 47  
internal batteries, 75  
internal battery, 7, 15, 75  
internal battery pack, 74  
items required for setup, 7

**L**

leak compensation, 33  
leak test, 21  
loops screen, 56  
low flow oxygen, 85  
low pressure Oxygen, 14

**M**

maintenance, 73  
mandatory breath, 39  
mandatory breath types, 36  
mandatory breaths, 38, 44  
maneuvers, 61  
manual breath, 3, 28  
MAP, 4  
maximum inspiratory time, 53  
mean airway pressure, 4  
membrane panel, 27  
method of sterilization, 72  
minute volume, 4  
MIP/NIF, 61  
mode selection options, 34  
monitor performance, 23  
monitor screen, 58  
monitored parameters, 23  
monitors, 59  
multiple alarms, 64

**N**

nebulization period, 11, 29  
NPPV, 1  
NPPV A/C, 37  
NPPV CPAP/PSV, 38  
NPPV SIMV, 38

**O**

O<sub>2</sub> sources, 13  
operator set controls, 45  
oxygen, 3, 85  
  low flow, 7  
  pressurized, 7  
oxygen concentration, 29, 85  
oxygen connections, 12  
oxygen sensor, 13  
oxygen supply, 7

**P**

panel lock, 30  
parallel printer port, 14, 31  
patient circuit  
  connections, 10  
patient circuits, 5  
patient effort, 38, 39, 87  
patient ID, 33  
patient identification number, 33  
patient select screen, 31  
patient settings, 32  
**PC Flow cycle**, 53  
peak flow, 3  
peak inspiratory pressure, 4, 23  
PEEP, 3, 4, 23, 43, 47  
percentage of oxygen, 48  
PIP, 4, 23  
**power fail check**, 23  
power source, 7  
power sources, 63, 74  
**pres high**, 48  
preset breath rate, 38, 39  
pressure control, 1  
pressure high control, 48  
pressure low control, 48  
pressure regulated volume control breaths, 43  
pressure support, 1, 3  
pressure supported breaths, 36  
primary breath controls, 45  
  inspiratory time, 47  
  pressure high, 48  
  pressure low, 48  
  time high, 48  
  time low, 48  
protective ground connection, 15  
PRVC A/C, 44  
PSV control, 47  
**PSV cycle**, 53  
**PSV Tmax**, 53

**R**

rear panel, 12  
reference loop, 57  
refinements to each primary breath control setting, 49  
remote nurse call, 12  
remote nurse call system, 14

**S**

scaling histograms, 60  
service calls, 79  
set the limits for each alarm, 65  
sigh, 53  
sigh volume breath, 53  
sigh volume breaths, 53  
SIMV, *I*  
SIMV mode, 39  
single mandatory breath, 28  
specifications and tolerances, 3, 4  
spontaneous breath, 36  
status indicators, 63  
switch check, 20  
symbols, xvi  
synchronized nebulizer flow delivery, 11, 29

**T**

test lung, 23  
the data dial, 46  
tidal volume, 3, 4, 23, 32, 46  
**time high**, 48  
    control, 48  
**time low**, 48  
    control, 48

titration of your patient's FiO<sub>2</sub> using the low pressure  
    Oxygen connector, 14  
touch screen, 1, 18, 19, 20, 21, 22, 30, 32, 33, 34, 35, 40,  
    45, 46, 49, 55, 56, 58, 59, 61, 64, 65  
trended data  
    histograms, 60  
    spreadsheet, 60  
trends screen, 60

**U**

user interface, 1  
User Verification Tests, xiv

**V**

ventilator alarms, 64  
    categories, 64  
ventilator inoperative alarm, 65  
verification testing, 18  
verification tests, 74  
vertical axis, 56  
VGA output connector, 14  
volume control, *I*  
Vsync, 52  
    **pressure control breaths**, 52  
    volume test breath, 52

**W**

warnings, *xii*  
warnings and cautions, *xii*  
waveform, 52  
waveforms, 55

This page intentionally left blank.