

## Operator's Manual

# Platinum™ Series XL, 5, 10

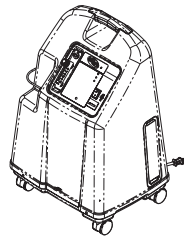

Oxygen Concentrators Standard,  
with SensO<sub>2</sub>® and HomeFill™ II



**Invacare 5 with SensO<sub>2</sub>**  
**Model IRC5LXO2**

**Invacare 5**  
**Model IRC5LX**

**Invacare 10 with SensO<sub>2</sub>**  
**Model IRC10LXO2**

**Invacare 10**  
**Model IRC10LX**

Dealer: This manual MUST be given to the end user.

User: Before using this product, read this manual and save for future reference.

**For more information regarding  
Invacare products, parts, and services,  
please visit [www.invacare.com](http://www.invacare.com)**



**Yes, you can.®**

---

**⚠ WARNING**

**DO NOT OPERATE THIS EQUIPMENT WITHOUT FIRST READING AND UNDERSTANDING THIS MANUAL. IF YOU ARE UNABLE TO UNDERSTAND THE WARNINGS, CAUTIONS, AND INSTRUCTIONS, CONTACT INVACARE TECHNICAL SERVICES BEFORE ATTEMPTING TO USE THIS EQUIPMENT - OTHERWISE SERIOUS INJURY OR PROPERTY DAMAGE MAY RESULT.**

---

**ACCESSORIES**

There are many different types of humidifiers, oxygen tubing, cannulas and masks that can be used with this device. You should contact your local home care provider for recommendations on which of these devices will be best for you. They should also give you advice on the proper usage, maintenance, and cleaning.

---

**⚠ WARNING**

**Invacare products are specifically designed and manufactured for use in conjunction with Invacare accessories. Accessories designed by other manufacturers have not been tested by Invacare and are not recommended for use with Invacare products.**

---

---

# TABLE OF CONTENTS

<b>ACCESSORIES .....</b>	<b>2</b>
<b>SPECIAL NOTES .....</b>	<b>5</b>
<b>SECTION 1—GENERAL GUIDELINES .....</b>	<b>6</b>
Maintenance.....	8
Radio Frequency Interference.....	8
To Reduce The Risk Of Burns, Electrocution, Fire Or Injury To Persons.....	9
Polarized Plug Instruction.....	10
<b>SECTION 2—FEATURES .....</b>	<b>11</b>
<b>SECTION 3—HANDLING .....</b>	<b>12</b>
Unpacking.....	12
Inspection.....	12
Storage.....	12
<b>SECTION 4—SPECIFICATIONS .....</b>	<b>13</b>
<b>SECTION 5—OPERATING INSTRUCTIONS .....</b>	<b>23</b>
Introduction.....	23
Select a Location .....	23
Recommended Guidelines for Optimum Performance.....	24
Plug in Power Cord .....	24
Connect Humidifier (If So Prescribed).....	25
Power Switch .....	27
Flowrate.....	28
SensO <sub>2</sub> Oxygen Purity Indicator (If Your Unit Features the O <sub>2</sub> Sensor Feature).....	29
Initial Startup of the Concentrator .....	29
Explanation of Oxygen Purity Indicator Lights.....	29
Indicators (If Your Unit Does Not Feature the O <sub>2</sub> Sensor) ...	30

---

# TABLE OF CONTENTS

<b>SECTION 6—MAINTENANCE .....</b>	<b>32</b>
Routine Maintenance.....	32
<b>SECTION 7—TROUBLESHOOTING GUIDE .....</b>	<b>35</b>
<b>LIMITED WARRANTY .....</b>	<b>38</b>

## SPECIAL NOTES

Signal words are used in this manual and apply to hazards or unsafe practices which could result in personal injury or property damage. Refer to the following table for definitions of the signal words

SIGNAL WORD	MEANING
DANGER	Danger indicates an imminently hazardous situation which, if not avoided, will result in death or serious injury.
WARNING	Warning indicates a potentially hazardous situation which, if not avoided, could result in death or serious injury.
CAUTION	Caution indicates a potentially hazardous situation which, if not avoided, may result in property damage.

### NOTICE

The information contained in this document is subject to change without notice.

### DANGER

**Users MUST not smoke while using this device. Keep all matches, lighted cigarettes or other sources of ignition out of the room in which this product is located. No smoking signs should be prominently displayed. Textiles and other materials that normally would not burn are easily ignited and burn with great intensity in oxygen enriched air. Failure to observe this warning can result in severe fire, property damage and cause physical injury or death.**

## SECTION I—GENERAL GUIDELINES

In order to ensure the safe installation, assembly and operation of the Platinum concentrator these instructions **MUST** be followed.

---

### **CAUTION**

“Caution: Federal law restricts this device to sale or rental by or on order of a physician, or any other practitioner licensed by the law of the State in which he/she practices to use or order the use of this device.”

---

### **⚠ WARNING**

**SECTION I - GENERAL GUIDELINES** contains important information for the safe operation and use of this product. **DO NOT** use this product or any available optional equipment without first completely reading and understanding these instructions and any additional instructional material such as **Owner’s Manuals, Service Manuals or Instruction Sheets** supplied with this product or optional equipment. If you are unable to understand the **Warnings, Cautions or Instructions**, contact a healthcare professional, dealer or technical personnel before attempting to use this equipment - otherwise, injury or damage may occur.

---

### **⚠ DANGER**

Risk of electric shock. **DO NOT** disassemble. Refer servicing to qualified service personnel.

---

**⚠ WARNING**

The use of oxygen therapy requires that special care be taken to reduce the risk of fire. Any materials that will burn in air, and some that will not, are easily ignited and burn rapidly in high concentrations of oxygen. For safety concerns, it is necessary that all sources of ignition be kept away from the product and preferably out of the room in which it is being used. NO SMOKING signs should be prominently displayed.

A spontaneous and violent ignition may occur if oil, grease or greasy substances come in contact with oxygen under pressure. These substances **MUST** be kept away from the oxygen concentrator, tubing and connections, and all other oxygen equipment. **DO NOT** use any lubricants unless recommended by Invacare.

For optimum performance, Invacare recommends that each concentrator be on and running for a minimum of 30 minutes at a time. Shorter periods of operation may reduce maximum product life.

If the concentrator has a damaged cord or plug, if it is not working properly, if it has been dropped or damaged, or dropped into water, call qualified technician for examination and repair.

Keep the oxygen tubing, cord, and unit away from heated or hot surfaces, including space heaters, blankets, stoves and similar electrical appliances.

**DO NOT** move or relocate concentrator by pulling on the cord.

**NEVER** drop or insert any object into any opening.

---

### **⚠ WARNING**

NEVER block the air openings of the product or place it on a soft surface, such as a bed or couch, where the air opening may be blocked. Keep the openings free from lint, hair and the like. Fill humidifier with water to the level shown by the manufacturer. DO NOT overfill.

Keep unit at least three inches away from walls, draperies, furniture, and the like.

Invacare recommends that Crush-Proof oxygen tubing be used with this product and not exceed 50 ft. (15.2m) in length. Recommended use for Platinum 10 is up to 50 ft. in length of high flow tubing.

### **Maintenance**

The Invacare Oxygen Concentrator was specifically designed to minimize routine preventive maintenance. Only professionals of the healthcare field or persons fully conversant with this process such as factory trained personnel should perform preventive maintenance or performance adjustments on the oxygen concentrator.

### **Radio Frequency Interference**

Most electronic equipment is influenced by Radio Frequency Interference (RFI). Caution should be exercised with regard to the use of portable communications equipment in the area around such equipment.

---



**⚠ WARNING**

**To Reduce The Risk Of Burns,  
Electrocution, Fire Or Injury To  
Persons.**

Avoid using while bathing. If continuous usage is required by the physician's prescription:

The concentrator **MUST** be located in another room at least seven (7) feet from the bath.

DO NOT come in contact with the concentrator while wet.

DO NOT place or store product where it can drop into water or other liquid.

DO NOT reach for product that has fallen into water. Unplug **IMMEDIATELY**.

A product should **NEVER** be left unattended when plugged in.

This device is to be used only in accordance with the prescription of a physician and this Owner's Manual. If at any time the patient or attendant conclude that the patient is receiving an insufficient amount of oxygen, the supplier and/or physician should be contacted **IMMEDIATELY**.

DO NOT change the L/min. setting on the flowmeter unless a change has been prescribed by your physician or therapist.

Close supervision is necessary when this product is used near children or physically-challenged individuals.

Use this product for only intended use as described in this manual.

DO NOT connect the concentrator in parallel or series with other oxygen concentrators or oxygen therapy devices.

**⚠ WARNING**

Use of some administration accessories or certain humidifiers not specified for use with oxygen concentrator may impair the performance.

In certain circumstances oxygen therapy can be hazardous. Invacare recommends that you seek medical advice before using this machine.

This equipment is to be used as an oxygen supplement and is not considered life supporting or life sustaining.

Avoid creation of any spark near medical oxygen equipment. This includes sparks from static electricity created by any type of friction.

## **Polarized Plug Instruction**

As a safety feature, this appliance has a polarized plug (one blade is wider than the other). This plug will fit in a polarized outlet only one way. If the plug does not fit fully in the outlet, reverse the plug. If it still does not fit, contact a qualified electrician. DO NOT attempt to defeat this safety feature.

---

# SECTION 2—FEATURES

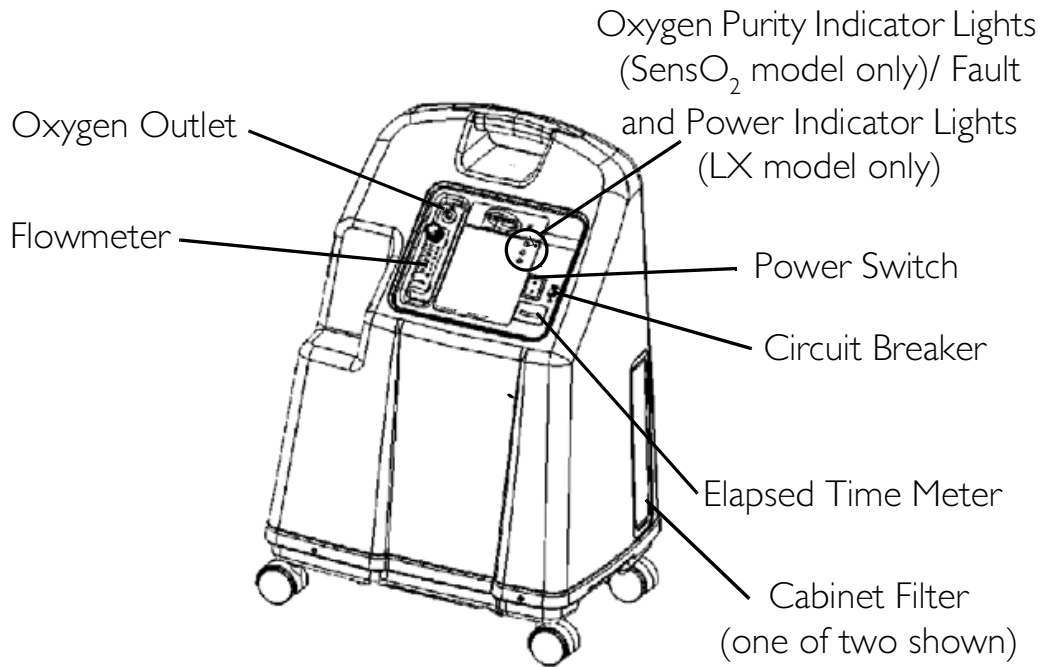

**ACCESSORIES (NOT SHOWN):**

Remote Humidifier/Flowmeter Accessory - IRCRF5 (Platinum 5 and XL Only)

PreciseRX™ Pediatric Humidifier/Flowmeter Accessory - IRCPFI 6 (Platinum 5 and XL Only)

HomeFill II home oxygen compressor - IOH200

**REAR VIEW**

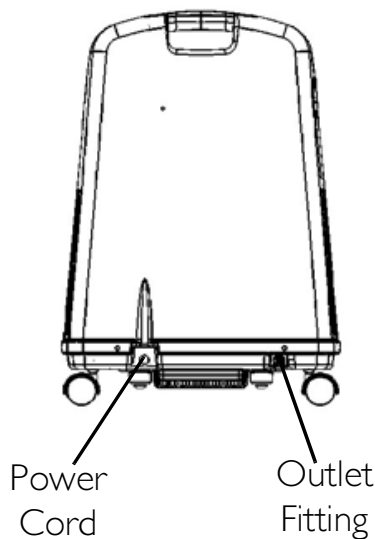

*NOTE: This outlet fitting is to be used only for filling oxygen cylinders with the HomeFill II home oxygen compressor. The outlet fitting does not affect concentrator performance. Refer to the HomeFill II owner's manual, part number 1100873, for connection and operating instructions. When not in use, the plug provided with the concentrator should be inserted into the outlet fitting. For more information about the HomeFill II, contact your Invacare dealer.*

## SECTION 3—HANDLING

The concentrator should ALWAYS be kept in the upright position to prevent cabinet damage while being transported. The shipping container has been designed to assure maximum protection of the concentrator.

If the concentrator is to be reshipped by common carrier, additional cartons are available from Invacare.

### Unpacking

*NOTE: For this procedure, refer to FIGURE 3.1.*

1. Check for any obvious damage to the carton or its contents. If damage is evident, notify the carrier, or your local dealer.
2. Remove all loose packing from the carton.
3. Carefully remove all the components from the carton.

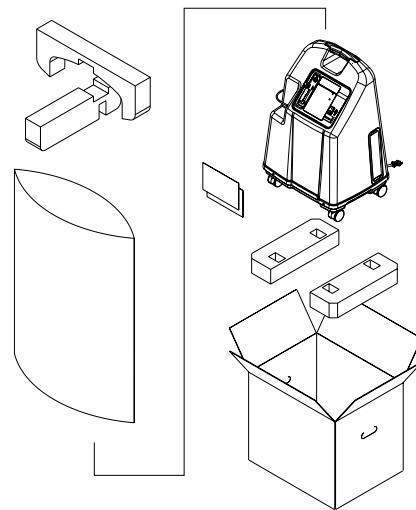

**FIGURE 3.1** Unpacking

*NOTE: Unless the oxygen concentrator is to be used IMMEDIATELY, retain containers and packing materials for storage until use of the concentrator is required.*

### Inspection

1. Inspect/examine exterior of the oxygen concentrator for nicks, dents, scratches or other damages. Inspect all components.

### Storage

1. Store the repackaged oxygen concentrator in a dry area.
2. DO NOT place objects on top of repackaged concentrator.



## SECTION 4—SPECIFICATIONS

Electrical Requirements:	120 VAC $\pm$ 10% (132 VAC/108 VAC), 60 Hz
Rated Current Input:	Platinum 5 and XL: 4.3 A
	Platinum 10: 4.7 A
Sound Level:	Platinum 5 and XL: 50 dB Average
	Platinum 10: 58 dB Average
Altitude:	Platinum 5 and XL - Up to 6,000 ft. (1828 meters) above sea level without degradation of concentration levels. From 6,000 ft. (1828 meters) to 13,129 ft. (4000 meters) below 90% efficiency
	Platinum 10 - Up to 4,000 ft. (1230 meters) above sea level without degradation of concentration levels. From 4,000 ft. (1230 meters) to 13,129 ft. (4000 meters) below 90% efficiency
*Oxygen Output Concentration Levels:	All 5LXO2/5LX models 95.6% to 87% at 0.5 to 5 L/min. and all 10LXO2/10LX models 95.6% to 87% at 2 L to 10 L/min.
Maximum Outlet Pressure:	Platinum 5 and XL: 5 psi $\pm$ 0.5 psi. (34.5 kPa $\pm$ 3.45 kPa.)
	Platinum 10: 9 psi $\pm$ 0.5 psi. (62.0 kPa $\pm$ 3.45 kPa.)

*\*NOTE: Stated concentration levels achieved after initial warm-up period (approximately 30 minutes).*

## SECTION 4—SPECIFICATIONS

### 5LXO<sub>2</sub> INDICATORS:

Label Symbol	O <sub>2</sub> Purity	Indicator Lights
	SYSTEM FAILURE Below 73%	<b>RED</b> - Continuous Audible Alarm Sieve-GARD™ Compressor Shutdown
	73% to 85%	<b>YELLOW</b>
O <sub>2</sub>	SYSTEM OKAY Over 85%	<b>GREEN</b>

### 5LX INDICATORS:

Label Symbol	Status	Indicator Lights
	SYSTEM FAILURE	<b>RED</b>
I/O	SYSTEM OKAY	<b>GREEN</b>

Flow Range:	Platinum 5 and XL - 0.5 to 5 L/min. For flowrates less than 1 L/min., we recommend the use of the Invacare Pediatric Flowmeter IRCPF16 Accessory.
	Platinum 10 - 2 L/min. to 10 L/min
Low Flow Alarm:	Platinum 5 - 0 L/min. to 0.5 L/min., Platinum 10 - 0 L/min. to 1 L/min. Rapid Audible Alarm Beeping (No Accessories Connected)
Average Power Consumption:	Platinum 5 and XL: 400W Platinum 10: 585W
Pressure Relief Mechanism Operational at:	35 psi ± 3.5 psi (241 kPa ± 24.1 kPa)
Change in maximum recommended flow when back pressure of 7kPa is applied:	0.7 L/min.

## SECTION 4—SPECIFICATIONS

Filters:	Cabinet (2), Outlet HEPA and Compressor Inlet.
Safety System:	Current overload or line surge shutdown. High temperature compressor shutdown. High Pressure Alarm w/compressor shutdown. Low Pressure Alarm w/compressor shutdown. Battery Free Power Loss Alarm. SensO <sub>2</sub> Oxygen System (SensO <sub>2</sub> Model) Low Flow Alarm.
Width:	18 3/8 in. ± 3/8 in. (46.7 cm ± 1 cm)
Height:	26 3/8 in. ± 3/8 in. (67.0 cm ± 1 cm)
Depth:	14 3/8 in. ± 3/8 in. (36.5 cm ± 1 cm)
Weight:	Platinum 5 and XL: 52 lbs ± 2 lbs (23.6 kg ± 1 kg)
	Platinum 10: 53 lbs ± 2 lbs (24.0 kg ± 1 kg)
Shipping Weight:	Platinum 5 and XL: 58 lbs ± 2 lbs (26.3 kg ± 1 kg)
	Platinum 10: 60 lbs ± 2 lbs (27.2 kg ± 1 kg)
Operating Ambient Temperature:	50°F - 95°F (10°C - 35°C) at 20-60% relative humidity
Exhaust:	Platinum 5 and XL: Less than Ambient + 35°F (+19°C).
	Platinum 10: Less than Ambient + 45°F (+25°C).
Oxygen Output:	Platinum 5 and XL: Less than Ambient + 4°F (+2°C).
	Platinum 10: Less than Ambient + 8°F (+4.4°C).
Cabinet:	Impact Resistant flame-retardant plastic cabinet that conforms to UL 94-V0.
Regulatory Listing:	Double Insulated Product ETL certified complying with UL 1097 ETL certified to CSA C22.2 No. 68
Electrical:	No extension cords.

## SECTION 4—SPECIFICATIONS

---

Placement:	No closer than three inches from any wall, furniture, draperies, or similar surfaces.
Tubing:	7 ft cannula with a maximum 50 ft of Crush-Proof Tubing (DO NOT pinch). Platinum 10: Recommended use up to 50 ft high flow tubing with high flow cannula at all flow rates.
Relative Humidity:	20 to 60%
Time of Operation:	Up to 24 hours per day.
Recommended Storage and Shipping Temperature:	-20°F to 150°F (-29°C to 65°C), at 15-95% relative humidity



# NOTES

# NOTES

Please Seal with  
Tape Before Mailing



## REGISTER YOUR PRODUCT!

### The benefits of registering:

1. Safeguard your investment.
2. Ensure long term maintenance and servicing of your purchase.
3. Receive updates with product information, maintenance tips, and industry news.
4. Invacare can contact you or your provider, if servicing is needed on your product.
5. It will enable Invacare to improve product designs based on your input and needs.

**Register ONLINE at [www.invacare.com](http://www.invacare.com)**

**- or -**

**Complete form and mail.**

Any registration information you submit will be used by Invacare Corporation only, and protected as required by applicable laws and regulations.

## PRODUCT REGISTRATION FORM

---

NAME \_\_\_\_\_

ADDRESS \_\_\_\_\_

CITY \_\_\_\_\_ STATE/PROVINCE \_\_\_\_\_

ZIP/POSTAL CODE \_\_\_\_\_

EMAIL \_\_\_\_\_ PHONE NO. \_\_\_\_\_

INVACARE MODEL NO. \_\_\_\_\_

SERIAL NO. \_\_\_\_\_

PURCHASED FROM \_\_\_\_\_

DATE OF PURCHASE: \_\_\_\_\_

---

1. Method of purchase: (check all that apply)  
 Medicare       Insurance       Medicaid       Other
2. This product was purchased for use by: (check one)  
 Self       Parent       Spouse       Other
3. Product was purchased for use at:  
 Home       Facility       Other
4. I purchased an Invacare product because:  
 Price       Features (list features)
5. Who referred you to Invacare products? (check all that apply)  
 Doctor     Therapist     Friend     Relative     Dealer/Provider     Other  
 Advertisement (circle one): TV, Radio, Magazine, Newspaper       No Referral
6. What additional features, if any, would you like to see on this product?  
\_\_\_\_\_
7. Would you like information sent to you about Invacare products that may be available for a particular medical condition?  Yes  No  
If yes, please list any condition(s) here and we will send you information by email and/or mail about any available Invacare products that may help treat, care for or manage such condition(s):  
\_\_\_\_\_
8. Would you like to receive updated information via email or regular mail about the Invacare home medical products sold by Invacare's dealers?  Yes  No  
\_\_\_\_\_
9. What would you like to see on the Invacare website?  
\_\_\_\_\_
10. Would you like to be part of future online surveys for Invacare products?  Yes  
 No
11. User's Year of birth: \_\_\_\_\_

If at any time you wish not to receive future mailings from us, please contact us at Invacare Corporation, CRM Department, 39400 Taylor Parkway, Elyria, OH 44035, or fax to 877-619-7996 and we will remove you from our mailing list.

---

TO FIND MORE INFORMATION ABOUT OUR PRODUCTS, VISIT  
[WWW.INVACARE.COM](http://WWW.INVACARE.COM)



NO POSTAGE  
NECESSARY  
IF MAILED  
IN THE  
UNITED STATES

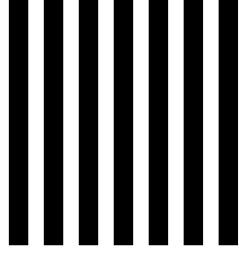

**BUSINESS REPLY MAIL**  
FIRST-CLASS MAIL PERMIT NO. 196 ELYRIA OH

POSTAGE WILL BE PAID BY ADDRESSEE

INVACARE CORPORATION  
CRM DEPARTMENT  
39400 TAYLOR PARKWAY  
ELYRIA OH 44035-9836



# **SECTION 5—OPERATING INSTRUCTIONS**

## **Introduction**

Your oxygen concentrator is intended for individual use in the home. It is an electronically operated device that separates oxygen from room air. It provides high concentration of oxygen directly to you through a nasal cannula. Clinical studies have documented that oxygen concentrators are therapeutically equivalent to other types of oxygen delivery systems.

Your provider will show you how to use your oxygen concentrator. He/She should be contacted with any questions or problems regarding your oxygen concentrator. This owner's manual will tell you about your concentrator and will serve as a reference as you use your concentrator.

## **Select a Location**

You may select a room in your house where using your oxygen concentrator would be most convenient. Your concentrator can be easily rolled from room to room on its casters.

Your oxygen concentrator will perform best when operated under the following conditions. Usage in environments other than those described may result in the need for increased equipment maintenance. The air intake of the unit should be located in a well ventilated area to avoid airborne pollutants and/or fumes.

## Recommended Guidelines for Optimum Performance

Temperature:	50°F - 95°F (10°C - 35°C)
Electrical:	No extension cords.
Placement:	No closer than three inches from the wall, furniture, draperies, or similar surfaces.
Tubing and Cannula:	7 ft cannula with a maximum 50 ft of Crush-Proof Tubing (DO NOT pinch).
	Platinum 10: Recommended use up to 50 ft high flow tubing with high flow cannula at all flow rates.
Environment:	Smoke and soot-free. No confined spaces (Example: No closets).
Relative Humidity:	20 to 60%
Time of Operation:	Up to 24 hours per day.
Flow Rate	Platinum 5 and XL: From 0.5 L/min. to 5 L/min. For flow rates less than 1 L/min., use the Pediatric Flowmeter Accessory.
	Platinum 10: From 2 L/min. to 10 L/min
Minimum Operating Time:	30 Minutes

*NOTE: Ensure that your concentrator is at least three inches away from walls, draperies or furniture to assure sufficient air flow. Avoid deep pile carpets and heaters, radiators or hot air registers.*

## Plug in Power Cord

1. Plug in power cord to an electrical outlet.



## Connect Humidifier (If So Prescribed)

*NOTE: For this procedure, refer to FIGURE 5.1 - FIGURE 5.4.*

*NOTE: Fill humidifier with distilled water to the level indicated by the manufacturer. (For Platinum 5, XL - recommended humidifiers are: Invacare 3260, 003-40, or 006-40. For Platinum 10, recommended humidifiers are high flow: 7900-10, 7900-25).*

---

### **⚠ WARNING**

**DO NOT overfill humidifier.**

**Replace the humidifier cap and securely tighten.**

**DO NOT reverse the oxygen input and output connections. Water from the humidifier bottle will travel through the cannula back to the patient.**

---

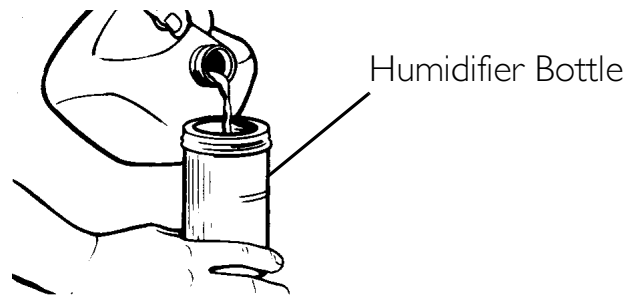

**FIGURE 5.1** Filling the Humidifier

2. Place the humidifier bottle in the humidifier compartment.

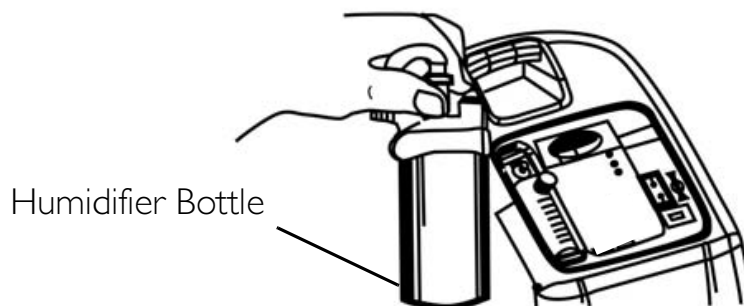

**FIGURE 5.2** Humidifier Compartment

## SECTION 5—OPERATING INSTRUCTIONS

3. Remove the filter access door located on the side of the concentrator. Insert a flathead screwdriver in the plate groove on the top edge of the filter access door and gently pry the filter access door open. Refer to Detail "A" in FIGURE 5.3.
4. The humidifier adapter is next to the inlet filter. Pull up and remove the humidifier bottle adapter. Refer to Detail "B" in FIGURE 5.3.
5. Attach it to the humidifier by turning the wing nut on the humidifier bottle counterclockwise until it is securely fastened. Refer to Detail "C" in FIGURE 5.3.

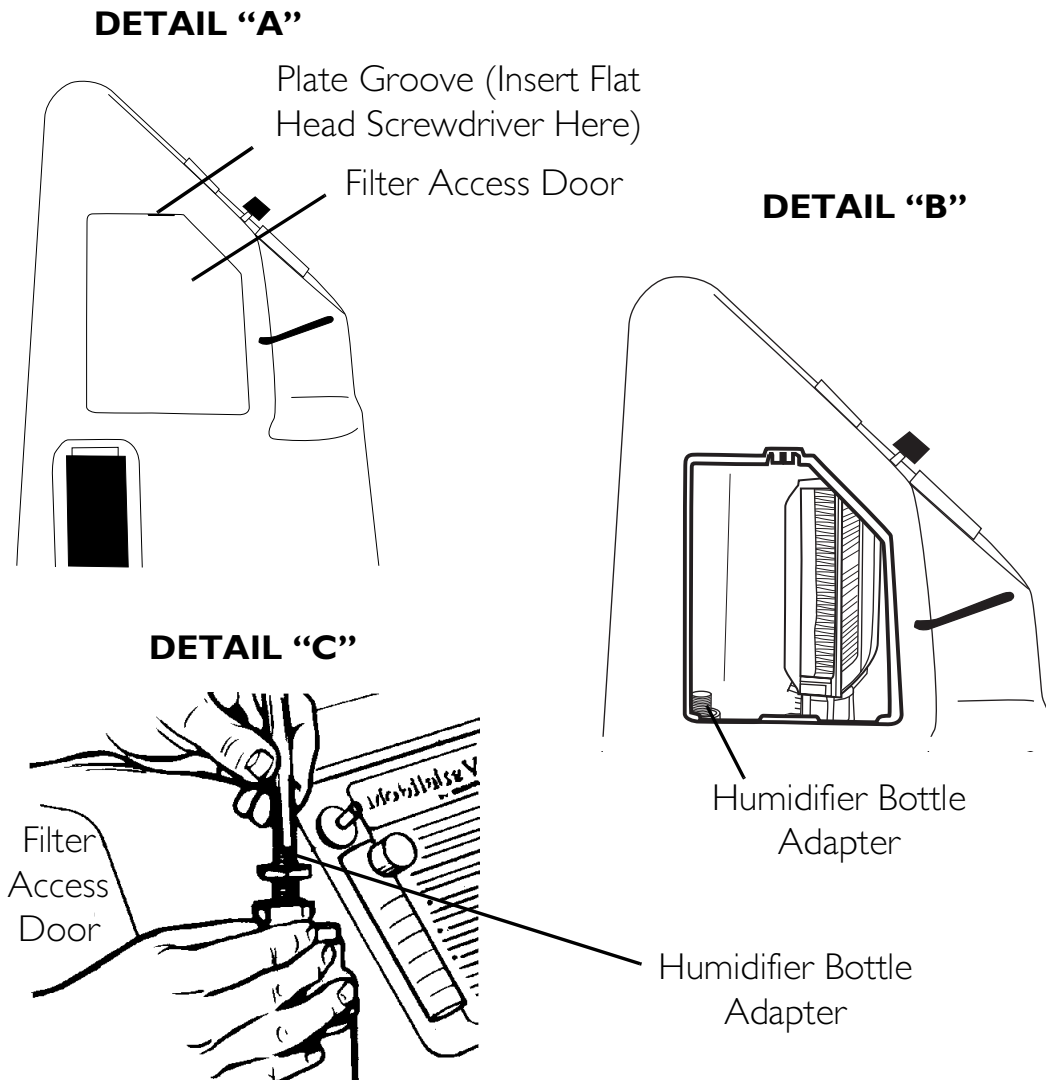

**FIGURE 5.3** Attaching the Humidifier Bottle Adapter

6. Attach oxygen tubing from the humidifier bottle to oxygen outlet connector on the oxygen concentrator (FIGURE 5.4).
7. Attach the cannula/patient supply tubing to the humidifier bottle outlet (FIGURE 5.4).
8. After assembly, ensure that oxygen is flowing through the cannula.

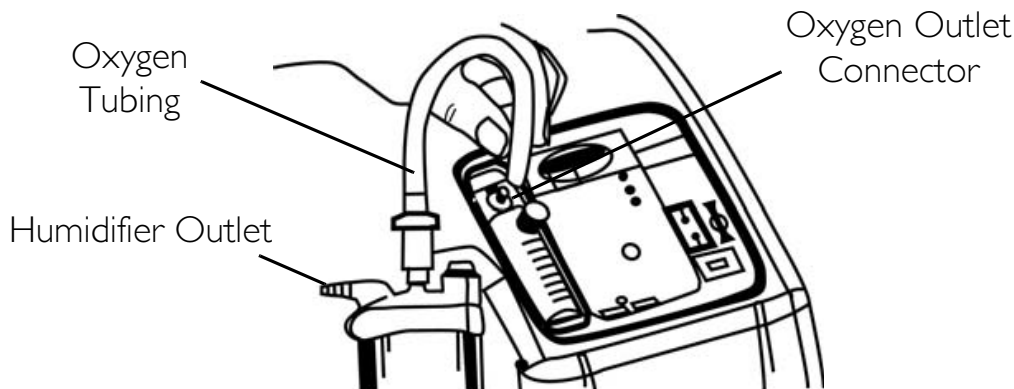

**FIGURE 5.4** Attaching the Oxygen Tubing

---

**⚠ WARNING**

**For optimum performance, Invacare recommends that each concentrator be on and running for a minimum of 30 minutes at a time. Shorter periods of operation may reduce maximum product life.**

---

## **Power Switch**

*NOTE: For this procedure, refer to FIGURE 5.5 on page 28.*

1. Press power switch to on position. All the panel lights and the audible alarm will come on for one second, indicating that the unit is functioning properly. After one second, only the GREEN system ok/power light will stay on.

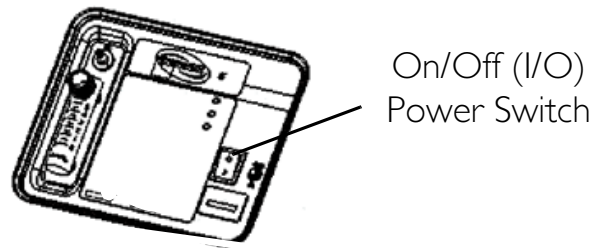

**FIGURE 5.5** Power Switch

## Flowrate

*NOTE: For this procedure, refer to FIGURE 5.6 on page 29.*

1. Turn the flowrate knob to the setting prescribed by your physician or therapist.

---

### **⚠ WARNING**

**DO NOT change the L/min. setting on the flowmeter unless a change has been prescribed by your physician or therapist.**

---

*NOTE: To properly read the flowmeter, locate the prescribed flowrate line on the flowmeter. Next, turn the flow knob until the ball rises to the line. Now, center the ball on the L/min. line prescribed.*

2. If the flowrate on the flowmeter ever falls below 0.5 L/min. for Platinum 5 (1 L/min. for Platinum 10) for more than about one minute, the LOW FLOW alarm will be triggered. This is a rapid beeping of the audible alarm. Check your tubing or accessories for blocked or kinked tubing or a defective humidifier bottle. After rated flow is restored, more than 0.5 L/min. for Platinum 5 (1 L/min. for Platinum 10), the LOW FLOW audible alarm will go off.

*NOTE: The use of some accessories such as the pediatric flowstand and the HomeFill II compressor will deactivate the Low Flow Alarm.*

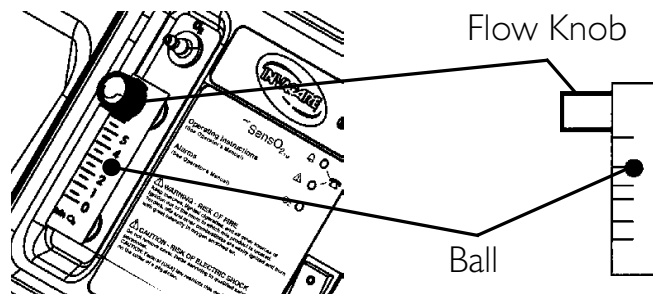

**FIGURE 5.6** Flowrate

## SensO<sub>2</sub> Oxygen Purity Indicator (If Your Unit Features the O<sub>2</sub> Sensor Feature)

This feature monitors the purity of oxygen generated by the oxygen concentrator. If purity falls below factory preset standards, indicator lights on the control panel will illuminate.

### Initial Startup of the Concentrator

*NOTE: Concentrator may be used during the initial start warm-up time (approximately 30 min.) while waiting for the O<sub>2</sub> purity to reach maximum.*

When the unit is turned on, the GREEN light will come on (SYSTEM OK/O<sub>2</sub> greater than 85%). After five (5) minutes, the oxygen sensor will be operating normally and will control the indicator lights depending on oxygen concentration values.

### Explanation of Oxygen Purity Indicator Lights

*NOTE: For this procedure, refer to FIGURE 5.7 on page 30.*

GREEN light (O<sub>2</sub>) - Normal Operation.

YELLOW light (⚠) - Call supplier IMMEDIATELY. You may continue to use the concentrator unless instructed otherwise by your supplier. Be certain that backup oxygen is nearby.

RED light (🔴) - Total unit shutdown. Switch IMMEDIATELY to backup oxygen supply. Call supplier IMMEDIATELY.

GREEN light - with YELLOW light flashing - Call supplier IMMEDIATELY. Oxygen sensor malfunctioning; you may continue to use the concentrator.

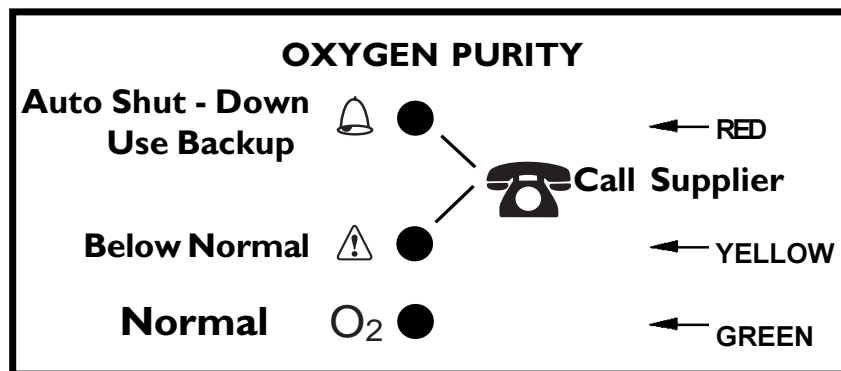

**FIGURE 5.7** SensO<sub>2</sub> Oxygen Purity Indicator (If Your Unit Features the O<sub>2</sub> Sensor Feature)

### Indicators (If Your Unit Does Not Feature the O<sub>2</sub> Sensor)

*NOTE: For this procedure, refer to FIGURE 5.8 on page 31.*

#### LX models indicator Light Explanation

RED light (🔴) - Total Unit Shut-Down. Switch IMMEDIATELY to a back-up oxygen supply. Call supplier IMMEDIATELY.

GREEN light (I/O) - On/Off. System okay.

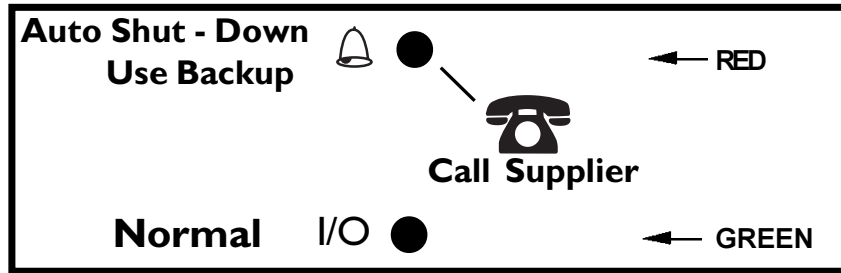

**FIGURE 5.8** Indicators (If Your Unit Does Not Feature the O<sub>2</sub> Sensor)

## SECTION 6—MAINTENANCE

*NOTE: The Invacare concentrators are specifically designed to minimize routine preventive maintenance. In places with high dust or soot levels, maintenance may need to be performed more often. Only authorized or factory-trained personnel should perform preventive maintenance on the concentrator. Power should be disconnected before beginning preventive maintenance on the Invacare concentrator.*

*NOTE: At a minimum, preventive maintenance MUST be performed according to the maintenance record guidelines. Refer to Preventive Maintenance Record on page 34.*

### Routine Maintenance

*NOTE: The following routine maintenance should be performed more frequently. See recommended intervals in each section and preventive maintenance record.*

#### Cleaning the Cabinet Filter

*NOTE: For this procedure, refer to FIGURE 6.1.*

*NOTE: There are two cabinet filters one located on each side of the cabinet.*

1. Remove each filter and clean at least once a week depending on environmental conditions.

*NOTE: Environmental conditions that may require more frequent cleaning of the filters include but are not limited to: high dust, smoking, air pollutants, etc.*

2. Clean the cabinet filters with a vacuum cleaner or wash in warm soapy water and rinse thoroughly.
3. Dry the filters thoroughly before reinstallation.



**CAUTION**

**DO NOT** operate the concentrator without the filters installed.

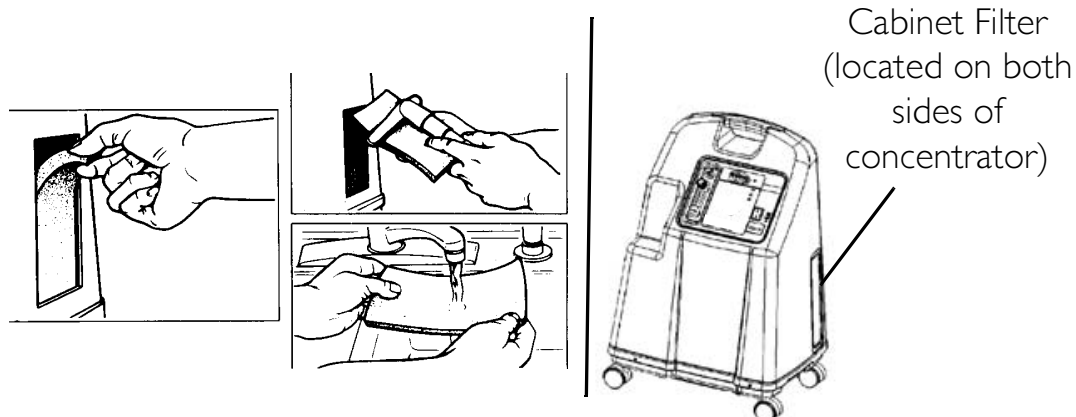

**FIGURE 6.1** Cleaning the Cabinet Filter

**Cabinet****⚠ WARNING**

**UNPLUG** the concentrator when cleaning. To avoid electrical shock, **DO NOT** remove cabinet.

1. Clean the cabinet with a mild household cleaner and non-abrasive cloth or sponge.

**Humidifier**

*NOTE: To clean the oxygen humidifier, follow the instructions provided by the manufacturer. If none are provided, follow these STEPS:*

1. Clean the humidifier every day.
2. Wash it in soapy water and rinse it with a solution of ten parts water and one part vinegar.
3. Rinse thoroughly with hot water and refill with distilled water to the level shown on the humidifier.

**⚠ WARNING**

**DO NOT** overfill humidifier bottle.



Yes, you can:

**PREVENTIVE MAINTENANCE RECORD  
INVACARE PLATINUM OXYGEN CONCENTRATOR**

MODEL NO. IRC \_\_\_\_\_ SERIAL NO. \_\_\_\_\_

**ON EACH INSPECTION**

Record Date of Service															
Record Elapsed Hours On Hour Meter															
Clean Cabinet Filter(s)															
Check Prescribed L/min. Flow Rate															
<b>EVERY 180 DAYS FOR IRC5LX (EVERY 90 DAYS FOR IRC10LX)</b>															
Check Oxygen Concentration (UNITS WITHOUT SensO <sub>2</sub> )															
<b>ANNUALLY, DURING PREVENTIVE MAINTENANCE SCHEDULE, OR BETWEEN PATIENTS</b>															
Clean/Replace Cabinet Filter(s)															
Check Outlet HEPA Filter*															
Check Compressor Inlet Filter*															
Check Oxygen Concentration (SensO <sub>2</sub> MODELS)															
Check Power Loss Alarm															
<b>AS REQUIRED</b>															
Clean Heat Exchanger															
Replace Exhaust Muffler															
Rebuild Top End of Compressor															

\*Refer to Preventive Maintenance section of Service Manual.

**FIGURE 6.2** Preventive Maintenance Record

## SECTION 7—TROUBLESHOOTING GUIDE

SYMPTOM:	PROBABLE CAUSE:	SOLUTION:
<b>Alarm:</b>	<b>Main Power Loss:</b>	1. Insert plug into outlet.
SHORT BEEPS, LONG PAUSE	1. Power cord NOT plugged in.	2. Inspect house circuit breakers or fuses. If problem recurs, use a different outlet.
Concentrator NOT operating, power switch ON.	2. No power at outlet.	3. Call Service Provider.
Beep.....Beep.....	3. Tripped circuit breaker.	
<b>Alarm:</b> CONTINUOUS  Concentrator NOT operating, Power Switch ON.  Beeeeeeep....	<b>System Failure:</b> 1. Unit overheating due to blocked air intake.  2. Insufficient power at outlet.  3. Internal repairs required	1a. Remove and clean cabinet filters.  1b. Move oxygen concentrator at least three inches away from walls, draperies or furniture.  2. DO NOT use extension cords. Move to another electrical outlet or circuit.  3. Call Service Provider.

## SECTION 7—TROUBLESHOOTING GUIDE

SYMPTOM:	PROBABLE CAUSE:	SOLUTION:
<p>YELLOW or RED LIGHT Illuminated.</p> <p>Alarm: CONTINUOUS On red light only.</p> <p>* Only applies to 5LXO<sub>2</sub> and 10LXO<sub>2</sub> SensO<sub>2</sub> models.</p>	<ol style="list-style-type: none"> <li>1. Low oxygen purity.*</li> <li>2. Kinked or blocked tubing, cannula or humidifier.*</li> <li>3. Flowmeter set at 0.5 L/min. for Platinum 5 and 1 L/min. for Platinum 10 or less.*</li> <li>4. Unit overheating due to blocked air intake.</li> <li>5. Insufficient power at outlet.</li> <li>6. Internal repairs required.</li> </ol>	<ol style="list-style-type: none"> <li>1. Clean or Replace filters.</li> <li>2. Inspect for kinks or blockages. Correct, clean or replace item. Once corrected, turn power OFF for 60 seconds and then turn power back ON.</li> <li>3. Check flowmeter is set to 1.0 L/min. or more. (Refer to <u>Recommended Guidelines for Optimum Performance</u> on page 24.</li> <li>4.a. Remove and clean cabinet filters.</li> <li>4b. Move concentrator at least three inches from walls, draperies, and furniture.</li> <li>5. DO NOT use extension cords. Move to another electrical outlet or circuit.</li> <li>6. Call Service Provider.</li> </ol>
<p>GREEN LIGHT with YELLOW Light Flashing.</p>	<ol style="list-style-type: none"> <li>1. Internal repairs required.</li> </ol>	<ol style="list-style-type: none"> <li>1. Call Service Provider.</li> </ol>

## SECTION 7—TROUBLESHOOTING GUIDE

SYMPTOM:	PROBABLE CAUSE:	SOLUTION:
<p><b>Alarm:</b> RAPID</p> <p>Beep....Beep... Beep...Beep</p>	<p><b>LOW FLOW ALARM</b></p> <p>Ia. Kinked or blocked tubing, cannula or humidifier.</p> <p>Ib. Flowmeter set at 0.5 L/min. for Platinum 5 and 1 L/min. for Platinum 10 or less.</p>	<p>Ia. Inspect for kinks or blockages. Correct, clean or replace item. Once corrected, turn power OFF for 60 seconds and then turn power back ON.</p> <p>Ib. Reset flowmeter to prescribed flowrate. If prescribed flowrate is below 0.5 L/min., use the Pediatric Flowmeter IRCPF16 (Only with Platinum 5 and XL).</p>

## LIMITED WARRANTY

**NOTE: THE WARRANTY BELOW HAS BEEN DRAFTED TO COMPLY WITH FEDERAL LAW APPLICABLE TO PRODUCTS MANUFACTURED AFTER JULY 4, 1975.**

This warranty is extended only to the original purchaser who purchases this product when new and unused from Invacare Corporation or a dealer. This warranty is not extended to any other person or entity and it is not transferable or assignable to any subsequent purchaser or owner. Coverage under this warranty will end upon any such subsequent sale or other transfer of title to any other person. This warranty gives you specific legal rights and you may also have other legal rights which may vary from state to state.

Invacare Corporation warrants its **Platinum XL Oxygen Concentrators** when purchased new and unused to be free from defects in materials and workmanship for a period of five (5) years from date of purchase from Invacare or a dealer, with a copy of the seller's invoice required for coverage under this warranty.

Invacare Corporation warrants its **Platinum 10 Oxygen Concentrators** when purchased new and unused to be free from defects in materials and workmanship for a period of three (3) years from date of purchase from Invacare or a dealer, with a copy of the seller's invoice required for coverage under this warranty.

**DO NOT OPEN OR ATTEMPT TO SERVICE THE 4-WAY VALVE BODY.** This will void any and all warranty applicable to the valve body. If within such warranty periods any such product shall be proven to Invacare Corporation's satisfaction to be defective, such product shall be repaired or replaced, at Invacare Corporation's option. This warranty only applies to the labor for repairs performed by the Invacare Service Department or Invacare Authorized Service Centers. It does not apply to the labor performed by the purchaser or user. This warranty does not include normal wear and tear or shipping charges. Invacare Corporation's sole obligation and your exclusive remedy under this warranty shall be limited to such repair or replacement. Routine maintenance items, such as filters, are excluded from this warranty.

For warranty service, please contact Invacare Corporation's Service Department at the toll free number on the back cover. Upon receiving notice of an alleged defect in a product, Invacare Corporation will issue a serialized return authorization. It shall then be the responsibility of the purchaser to return the entire unit or remove, at purchaser's cost, the defective component part(s) identified, pack the component part(s) in a manner to avoid shipping damage and to ship the component part(s) to either Invacare Corporation's plant or service center as specified by Invacare Corporation in advance. Defective component part(s) **MUST** be returned for warranty inspection using the serial number as identification within thirty (30) days of return authorization date. **DO NOT** return products to our factory without prior consent. C.O.D. shipments will be refused; please prepay shipping charges.

**LIMITATIONS AND EXCLUSIONS: THE FOREGOING WARRANTY SHALL NOT APPLY TO PRODUCTS SUBJECTED TO NEGLIGENCE, ACCIDENT, IMPROPER OPERATION, MAINTENANCE OR STORAGE, SOOT OR SMOKE-FILLED ENVIRONMENTS, OR OTHER THAN NORMAL APPLICATION, USE OR SERVICE, OR TO PRODUCTS MODIFIED WITHOUT INVACARE CORPORATION'S EXPRESS WRITTEN CONSENT (INCLUDING, BUT NOT LIMITED TO, MODIFICATION THROUGH THE USE OF UNAUTHORIZED PARTS OR ATTACHMENTS) OR TO PRODUCTS DAMAGED BY REASON OF REPAIRS MADE TO ANY COMPONENT WITHOUT THE SPECIFIC CONSENT OF INVACARE CORPORATION OR TO PRODUCTS DAMAGED BY CIRCUMSTANCES BEYOND INVACARE CORPORATION'S CONTROL.**

**THE FOREGOING EXPRESS WARRANTY IS EXCLUSIVE AND IN LIEU OF ANY OTHER WARRANTIES WHATSOEVER, WHETHER EXPRESS OR IMPLIED, INCLUDING THE IMPLIED WARRANTIES OF MERCHANTABILITY AND FITNESS FOR A PARTICULAR PURPOSE, AND THE SOLE REMEDY FOR VIOLATIONS OF ANY WARRANTY WHATSOEVER, SHALL BE LIMITED TO REPAIR OR REPLACEMENT OF THE DEFECTIVE PRODUCT PURSUANT TO THE TERMS CONTAINED HEREIN. THE APPLICATION OF ANY IMPLIED WARRANTY WHATSOEVER SHALL NOT EXTEND BEYOND THE DURATION OF THE EXPRESS WARRANTY PROVIDED HEREIN. INVACARE SHALL NOT BE LIABLE FOR ANY CONSEQUENTIAL OR INCIDENTAL DAMAGES WHATSOEVER.**

**SOME STATES DO NOT ALLOW THE EXCLUSION OR LIMITATION OF INCIDENTAL OR CONSEQUENTIAL DAMAGE, OR LIMITATION OF HOW LONG AN IMPLIED WARRANTY LASTS, SO THE ABOVE EXCLUSION AND LIMITATION MAY NOT APPLY TO YOU.**

**THIS WARRANTY SHALL BE EXTENDED TO COMPLY WITH STATE/PROVINCIAL LAWS AND REQUIREMENTS.**

---

This product may be manufactured under one or more of the following patents: US 5,906,672 and US 5,917,135. Other patents pending.



**Yes, you can.®**

**Invacare Corporation**

[www.invacare.com](http://www.invacare.com)

**USA**

One Invacare Way  
Elyria, Ohio USA  
44036-2125  
800-333-6900  
Technical Services  
800-832-4707

Invacare, Yes, you can., SensO<sub>2</sub>, and the Medallion Design are registered trademarks of Invacare Corporation. Platinum, HomeFill, Sieve-Gard, Precise R<sub>x</sub> are trademarks of Invacare Corporation.  
© 2006 Invacare Corporation

Part No 1118353    Rev H - 08/09/06