



Respironics Inc.  
1001 Murry Ridge Lane  
Murrysville, PA 15668 USA



**REF 1091945**

1091777 R03

AEM 09/24/2018

CoughAssist T70 | USER MANUAL



# FOR HOME CARE PROVIDER USE ONLY

## Accessing Prescription Setting Screens



*The information on this page is ONLY for home care providers. Remove this page from the manual before giving the manual to the patient.*

### Full and Limited Menu Access Modes

The device has two levels of menu access, Full and Limited. There are three Presets available. Full Menu access allows the user to change all settings. Limited Menu access only allows the user to select between Presets when therapy is not being delivered. See Chapter 4 for more information.

When the device is in Limited Menu access mode, use the following key sequence to enter Full Menu Access Mode:

- From the Standby or Monitor screen, select the Down button and hold the Manual switch to the right (Inhale). If the foot pedal is connected to the therapy device, you can alternatively press the Inhale Foot Pedal and Down key at the same time. This temporarily puts the device into Full Menu Access Mode and displays the  symbol in the status panel at the top of the screen.

You can access the Settings and Options menus and permanently change the Menu Access setting to Full. Otherwise, the device will return to Limited mode after five minutes of inactivity.

### Setup Screen

The Setup Screen allows you to modify prescription settings and device settings while the blower is not running. The Setup Screen can only be activated when the device is off. To activate the Setup Screen, use the following key sequence:

- While the device is in OFF mode, select the Down button and hold the Manual switch to the right (Inhale). If the foot pedal is connected to the therapy device, you can alternatively press the Inhale Foot Pedal and Down key at the same time.

When the Setup Screen is displayed, the device will be in Full Menu Access Mode to enable parameter changes. The Setup Screen looks just like the Standby Screen (see the Accessing the Standby Screen section) and performs the same functions with the following exceptions:

- “Standby” is replaced with “Setup.”
- The right soft key will initiate “Standby” when activated.
- No accessory module data is presented.

To exit the Setup Screen, select the  button to turn the device off or select the right soft key to activate Standby. If the device was in Limited Menu Access Mode when the Setup Screen was entered, it will return to Limited Menu Access Mode when the Setup Screen exits to either the off state or the Standby Screen.

The Setup Screen has a timeout of 10 minutes. The timer restarts when a key is touched or the Manual switch is toggled. When time expires, the device returns to Limited Menu Access Mode, if it was in that mode prior to Setup Screen activation, and the screen turns off.

**Note:** *Philips Respironics recommends that you set the device back to Limited Menu Access mode before returning it to the patient so patients cannot change their prescription settings.*



# Table of Contents

Chapter 1. Introduction.....	1
1.1 Package Contents.....	1
1.2 Intended Use.....	2
1.3 Warnings and Cautions.....	2
Warnings.....	2
Cautions.....	4
1.4 Contraindications.....	4
1.5 System Overview.....	5
1.6 Symbols.....	9
1.7 Traveling with the System.....	11
1.8 How to Contact Philips Respironics.....	11
Chapter 2. Therapy Modes and Features.....	13
2.1 Inhalation/Exhalation Therapy Modes.....	13
2.2 Therapy Features.....	17
2.2.1 Cough-Trak.....	17
2.2.2 Oscillation.....	17
2.2.3 Pre-Therapy Breaths.....	17
2.2.4 Post-Therapy Breath.....	17
2.2.5 Manual Override.....	18
Chapter 3. Device Setup.....	19
3.1 Install the Air Filter.....	19
3.2 Position the Device Properly.....	19

3.3 Assemble the Patient circuit .....	20
3.4 Supply Power to the Device.....	20
3.4.1 Using AC Power.....	20
3.4.2 Using DC Power .....	21
3.4.3 Device Power Source Indicators.....	22
3.5 Daily Use .....	22
3.5.1 Manual Mode.....	22
3.5.2 Auto Mode .....	23
3.5.3 Advanced Auto Mode:.....	23
3.5.4 Preset Settings.....	24
Chapter 4. Viewing and Changing Settings.....	25
4.1 Navigating the Menu Screens.....	25
4.1.1 Screen Timeout Periods .....	25
4.2 Accessing the Standby Screen.....	26
4.3 Accessing the Monitor Screen .....	26
4.3.1 Monitor Screen Content .....	27
4.4 Modifying Patient Therapy Settings .....	32
4.5 Changing Device Settings .....	36
4.5.1 Changing Options Menu Settings.....	37
4.5.2 Viewing Device Data .....	38
4.5.3 Viewing the Information Log .....	39
Chapter 5. Cleaning and Maintenance .....	41
5.1 Cleaning the Device.....	41
5.2 Cleaning and Replacing the Air Filter.....	41
5.3 Cleaning the Patient Circuit.....	42
5.3.1 Institutional (Hospital) Use .....	42
5.3.2 Home (Individual) Use .....	42
5.4 Preventive Maintenance .....	42
Chapter 6. Accessories.....	43
6.1 SD Card.....	43

6.2 Oximetry Cable.....	44
6.3 Foot Pedal.....	44
6.4 Carrying Case .....	44
6.5 Roll Stand.....	44
6.6 Supplemental Oxygen.....	44
Chapter 7. Troubleshooting.....	45
7.1 Informational Messages.....	45
7.2 Troubleshooting.....	46
Chapter 8. Technical Specifications .....	49
Chapter 9. EMC Information.....	53
Limited Warranty.....	57



# 1. Introduction

## 1.1 Package Contents

The CoughAssist T70 system may include the following components. Some components are optional accessories that may not be packaged with the device.

### **CORE PACKAGE**

- CoughAssist T70 Device
- Patient Circuit, including bacteria filter, 6 ft (1.83 m) flexible tubing, and Adult Large Mask
- Carrying Case
- AC Power Cord
- Air Filter
- Hose Clip
- SD Card
- This User's Manual

### **ACCESSORIES**

- Detachable Battery
- Detachable Battery Charger
- Foot Pedal
- Various Patient Interface Accessories (Mask sizes, trach adapters, mouthpiece interface, water trap, flexible tubing)
- Patient Circuit with either 6 ft (1.83 m) or 9 ft (2.74 m) Tubing
- Oximetry Interface Kit
- External Battery Cable
- DC Auto Adapter
- Roll Stand



## 1.2 Intended Use

The Philips Respironics CoughAssist T70 is intended for use on adult or pediatric patients unable to cough or clear secretions effectively. It may be used either with a facemask or mouthpiece, or with an adapter to a patient's endotracheal or tracheostomy tube. The device is intended to be used in the hospital, institutional environment or in the home

When using Oscillations: The device promotes airway clearance by gradually applying air pulse generated high frequency oscillatory vibrations on the positive and negative pressures applied to the chest wall via the airways. The high frequency oscillatory vibrations release mucus from the bronchial walls, increasing mobilization. The shift in pressure produces a high expiratory flow from the lungs, promoting the clearance of the mobilized secretions via coughing.

## 1.3 Warnings and Cautions

**CAUTION:** U.S. federal law restricts this device to sale by or on the order of a physician.

### Warnings

*A warning indicates the possibility of injury to the user or operator.*

- Always check time and pressure settings before each treatment.
- Always use a new bacteria filter when using the device on a new patient.
- Patients known to have cardiac instability should be monitored for pulse and oxygen saturation very closely.
- Monitor the device while in use and stop using it if the device malfunctions.
- Soreness and/or pain in the chest from a pulled muscle may occur in patients using the CoughAssist T70 for the first time if the positive pressure used exceeds pressures which the patient normally receives during Positive Pressure Therapy. Such patients should start at a lower positive pressure during treatment, and gradually (over several days, or as tolerated) increase the positive pressure used. [Positive Pressure Therapy includes the use of a volume ventilator, nasal or mask ventilation or CPAP (Continuous Positive Airway Pressure), or IPPB (Intermittent Positive Pressure Breathing).]
- Do not use in the presence of flammable anesthetics.
- Do not place or store the device where it can fall or be pulled into a tub or sink.
- Unplug the device if it comes into contact with water.
- Do not operate device while in carrying case.
- Never operate the CoughAssist T70 if it has a damaged cord or plug, is not working properly, or has been dropped, damaged or immersed in water.

- Do not remove the cover; there are no serviceable parts inside the device. Have the device serviced by authorized personnel only.
- Use only power cords supplied by Philips Respironics for this device. Use of power cords not supplied by Philips Respironics may cause overheating or damage to the device.
- Be aware that the electrical cord and/or tubing could present a tripping or strangulation hazard.
- The use of accessories, transducers, and cables other than those specified by Philips Respironics may result in increased emissions or decreased immunity of the device. For optimum performance, the CoughAssist T70 should be used with the patient interfaces provided by Philips Respironics.
- Portable RF communications equipment (including peripherals such as antenna cables and external antennas) should be used no closer than 30 cm (12 inches) to any part of the device, including cables specified by the manufacturer. Otherwise, degradation of the performance of this equipment could result.
- Medical Electrical Equipment needs special precautions regarding EMC and needs to be installed and put into service according to the EMC information provided in this manual.
- This device must only be used under the direction of a physician.
- This device shall not be used near active HIGH FREQUENCY (HF) SURGICAL EQUIPMENT or in an RF shielded room of medical equipment or system for magnetic resonance imaging, where the intensity of ELECTROMAGNETIC (EM) DISTURBANCES is high.
- This device must only be used by trained personnel.
- When administering fixed-flow supplemental oxygen, the oxygen concentration may not be constant. The inspired oxygen concentration will vary, depending on the pressures, patient flows, and circuit leak. Substantial leaks may reduce the inspired oxygen concentration to less than the expected value. Appropriate patient monitoring should be used, as medically indicated, such as an alarming pulse oximeter.
- When using oxygen with this system, the oxygen supply must comply with local regulations for medical oxygen.
- Do not connect the device to an unregulated or high pressure oxygen source.
- Oxygen supports combustion. Oxygen should not be used while smoking or in the presence of an open flame.
- Do not use the device near a source of toxic or harmful vapors.
- When using oxygen with this system, turn the device on before turning on the oxygen. Turn the oxygen off before turning the device off. This will prevent oxygen accumulation in the device. **Explanation of the Warning:** When the device is not in operation and the oxygen flow is left on, oxygen delivered into the tubing may accumulate within the device's enclosure. Oxygen accumulated in the device enclosure will create a risk of fire.

## **Cautions**

*A caution indicates the possibility of damage to the device.*

- Condensation may damage the device. If this device has been exposed to either very hot or very cold temperatures, allow it to adjust to room temperature (operating temperature) before starting therapy. Do not operate the device outside of the operating temperature range shown in the Specifications.
- Position the CoughAssist T70 so that the air ports on the side, bottom, and back of the device are not blocked. The device should not be used adjacent to or stacked with other equipment. For more information, contact your home care provider.
- Never operate the device unless a bacteria filter is attached to the patient circuit.
- Turn the device off when not in use.
- Keep the power cord away from heated surfaces.
- Do not sterilize with ethylene oxide gas or steam sterilize.

## **Notes**

- This product does not contain natural latex rubber or dry natural rubber in patient or operator accessible areas or in the air path.

## **1.4 Contraindications**

If the patient has any of the following conditions, consult their health care professional before using the device:

- A history of bullous emphysema
- Susceptibility to pneumothorax or pneumo-mediastinum
- Any recent barotrauma

When using the Oscillation feature, if the patient has any of the following conditions, consult their health care professional before using the device:

- Current or recent pneumothorax or pneumo-mediastinum
- Interstitial lung disease
- Recent lung surgery
- Pleural lung disease
- Acute Respiratory Distress Syndrome (ARDS)
- Acute Severe Lung Injury
- Bronchopulmonary Dysplasia
- Infant Respiratory Distress Syndrome
- The CoughAssist T70 device is not intended for neonates or premature infants.

## 1.5 System Overview

The CoughAssist T70 removes secretions in patients with an ineffective ability to do so on their own. The device clears secretions by providing high frequency oscillatory vibrations while gradually applying a positive pressure to the airway, then rapidly shifting to a negative pressure. The rapid shift in pressure produces a high expiratory flow rate from the lungs, simulating a natural cough. The air is delivered to and from the patient through the patient circuit, which includes a flexible tube, bacteria filter, and either a mask, mouthpiece, or an adapter to a tracheostomy or endotracheal tube.

Those who might benefit from the use of the CoughAssist T70 include any patient with an ineffective cough due to muscular dystrophy, myasthenia gravis, poliomyelitis, or other neurologic disorder with some paralysis of the respiratory muscles, such as spinal cord injury. It may also be used to treat ineffective secretion removal due to other bronchopulmonary diseases, such as emphysema, cystic fibrosis and bronchiectasis. It is effective for both invasively and non-invasively ventilated, and non-ventilated patients.

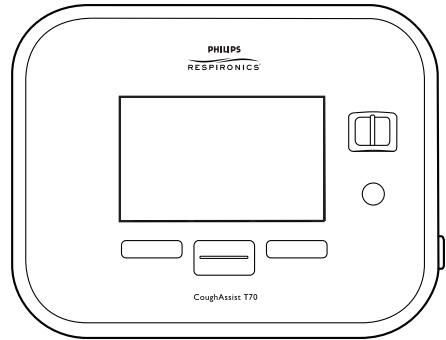

### 1.5.1 Front Panel Features

The items numbered in the illustration below are described in the table that follows.



Item		Description
1	Left Button	This button allows you to select display options or perform certain actions specified on-screen.
2	Up/Down Button	This button allows you to navigate the display menu and edit device settings.
3	Right Button	This button allows you to select display options or perform certain actions specified on-screen.
4	Power On/Power Off Button	This button turns the device on or off.
5	Manual Switch	<p>The Manual switch activates the exhale and inhale phases. Pressing the switch to the right (+) activates the inhale phase, while pressing it to the left (-) activates the exhale phase. Leaving the switch in the middle activates the pause phase.</p> <p>Pressing the Manual Switch either on the right or the left for more than 3 seconds, and then back to the middle, gives access to Manual Override (see the Manual Override section).</p>
6	Display Screen	The display screen allows you to view settings, system status information, real-time patient data, and logs. You can also modify certain settings on the display screen.

## 1.5.2 Back Panel Features

The items numbered in the illustration below are described in the table that follows.

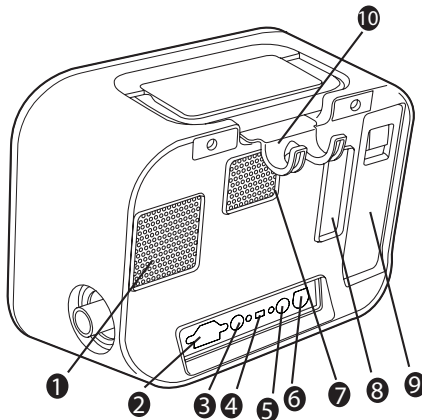

Item		Description
1	Fan Exhaust	Location where air from inside the device is expelled.
2	AC Power Inlet	Connect the AC power cord here.
3	Remote Control Connector	If you are using a remote control accessory (foot pedal) to initiate manual therapy, connect the remote control cable to this connector.
4	USB Connector	Connect a USB cable to this connector for service only.
5	SpO <sub>2</sub> Connector	If you are using the optional oximetry cable, connect the oximetry cable to this connector.
6	DC Power Inlet	Connect an external battery here using the Philips Respironics DC Power Cord.
7	Airpath Outlet	Location where air exits the device.
8	Airpath Inlet (Filter Area)	Location where outside air enters the device. Insert the filter supplied with the device here.
9	Detachable Battery Slot	If you are using the Philips Respironics Lithium-Ion detachable battery to power the device, attach it here. Remove the battery slot cap before use.
10	Tubing Retainer	Route the tubing and mask through this bracket for proper tubing management when the device is not in use.

### 1.5.3 Side Panel Features



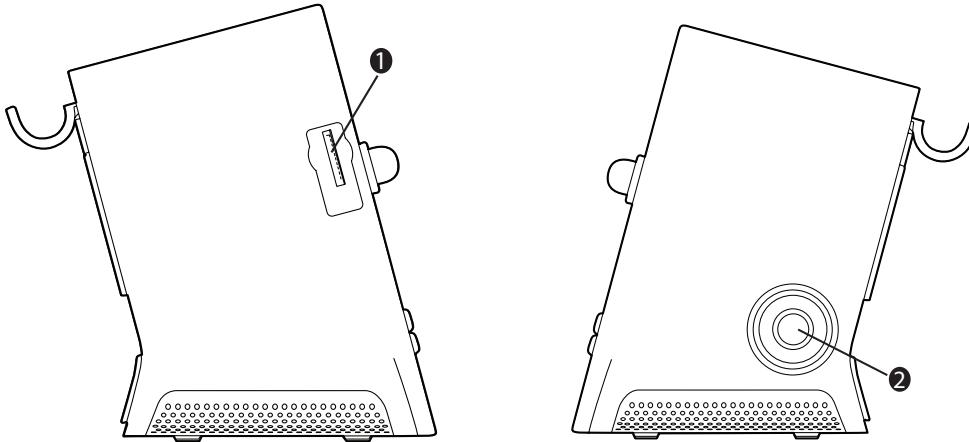





The items numbered in the illustration below are described in the table that follow











Item		Description
1	SD Card Slot	You can insert the optional SD card into this slot if you are recording patient data from the device.
2	Patient circuit Connection	You can connect your circuit tubing to this connector on the device.

## 1.6 Symbols

The following symbols appear on the device or packaging.

Symbol	Title and meaning	Reference
	Operator's manual; operating instructions Consult instructions for use.	IEC 60878 ISO 7000-1641 Symbol 5.4.3, ISO 15223-1
	DC power (Direct current) Indicate on the rating plate that the equipment is suitable for direct current only; to identify relevant terminals.	IEC 60417-5031
	AC power (Alternating current) Indicates on the rating plate that the equipment is suitable for alternating current only; to identify relevant terminals.	IEC 60417-5032
	Remote Control	ISO 7000-0093
	USB Connector	
	Type BF applied part To identify a type BF applied part complying with IEC 60601-1.	IEC 60878 IEC 60417-5333
	Class II equipment (Double Insulated) To identify equipment meeting the safety requirements specified for Class II equipment.	IEC 60878 IEC 60417-5172
<b>IP22</b>	Drip proof equipment	IEC 60529
	Therapy on/off (Stand-by) Identifies the button to turn therapy on or off (puts the device in a stand-by condition).	IEC 60878 IEC 60417-5009
<b>+</b>	Plus; positive polarity	IEC 60417-5005
<b>-</b>	Minus; negative polarity	IEC 60417-5006



	Protective earth; protective ground; Located next to a terminal inside the device to identify the protective earth connection.	IEC 60417-5019
	Prescription device Caution: U. S. federal law restricts this device to sale by or on the order of a physician.	
	For airline use.	RTCA/DO-160F section 21, category M
	Humidity limitation Indicates the range of humidity to which the medical device can be safely exposed.	IEC 60878 ISO 7000-2620 Symbol 5.3.8, ISO 15223-1
	Temperature limit Indicates the storage temperature limits to which the medical device can be safely exposed.	IEC 60878 ISO 7000-0632 Symbol 5.3.7, ISO 15223-1
	Manufacturer Indicates the medical device manufacturer.	IEC 60878 ISO 7000-3082 Symbol 5.1.1, ISO 15223-1
	Reorder number Indicated the manufacturer's catalogue number so the medical device can be identified.	ISO 7000-2493 Symbol 5.1.6, ISO 15223-1
	Serial number Identify the manufacturer's serial number for the medical device.	IEC 60878 ISO 7000-2498 Symbol 5.1.7, ISO 15223-1

ISO 7000:2014, Graphical symbols for use on equipment – Registered symbols

ISO 7010:2011+A1:2012+A2:2012+A3:2012+A4:2013+A5:2014+A6:2014, Graphical symbols -- Safety colours and safety signs -- Registered safety signs (not currently FDA recognized)

EN 15986:2011, Symbols for medical devices containing phthalates (not currently FDA recognized)

ISO 15223-1:2012, Medical devices—Symbols to be used with medical devices labels - General requirements

IEC 60417:2002 DB, Graphical symbols for use on equipment

IEC/TR 60878:2015, Graphical symbols for electrical equipment in medical practice

Additionally, the following abbreviation appears on the device:

Symbol	Title and meaning
SpO <sub>2</sub>	SpO <sub>2</sub> (Oximetry) Connector

## 1.7 Traveling with the System

For your convenience at security stations, there is a note on the bottom of the device stating that it is medical equipment. It may be helpful to bring this manual along with you to help security personnel understand the device.

If you are traveling to a country with a line voltage different than the one you are currently using, a different power cord or an international plug adaptor may be required to make your power cord compatible with the power outlets of the country to which you are traveling.

## 1.8 How to Contact Philips Respironics

To have your device serviced, contact Philips Respironics Customer Service department at 1-724-387-4000 or 1-800-345-6443.

Respironics Inc.  
1001 Murry Ridge Lane  
Murrysville, PA 15668 USA





# CoughAssist T70

## user manual

## 2. Therapy Modes and Features

### 2.1 Inhalation/Exhalation Therapy Modes

Therapy Mode	Description
Manual	<p>Manual mode delivers therapy based on the Inhale Pressure and Exhale Pressure prescription settings. The device delivers the set inhalation pressure for the amount of time that the Manual switch is held in the inhalation position. The device delivers the set exhalation pressure for the amount of time that the Manual switch is held in the exhalation position. Therapy starts in the pause phase when activated in Manual mode.</p>
Auto	<p>Auto mode delivers therapy based on the following prescription settings: Inhale Pressure, Exhale Pressure, Inhale Time, Exhale Time, and Pause Time. Auto mode delivers pressure in the following sequence, repeating the sequence until the user exits the therapy state:</p> <ol style="list-style-type: none"><li>1. Positive pressure at the Inhale Pressure setting for the duration of the Inhale Time setting.</li><li>2. Negative pressure at the Exhale Pressure setting for the duration of the Exhale Time setting.</li><li>3. Atmospheric pressure for the duration of the Pause Time setting.</li></ol> <p>When the Cough-Trak feature is enabled, Auto mode delivers pressure in the following sequence, repeating the sequence until the user exits the therapy state:</p> <ol style="list-style-type: none"><li>1. Positive pressure at the Inhale Pressure setting when the device detects the patient's effort to inhale for the duration of the Inhale Time setting.</li><li>2. Negative pressure at the Exhale Pressure setting for the duration of the Exhale Time setting.</li><li>3. Atmospheric pressure until the device detects the next inspiratory effort.</li></ol> <p>The Cough-Trak feature is described in more detail later in this chapter.</p>

Advanced Auto	<p>Advanced Auto mode delivers therapy based on the following prescription settings: Pre-Therapy Breaths, Pre-Therapy Pressure, Pre-Therapy Flow, Pre-Therapy Time, Pre-Therapy Pause, Number of Coughs, Inhale Pressure, Exhale Pressure, Inhale Time, Exhale Time, Pause Time, Number of Cycles, and Post-Therapy Breath. Advanced Auto mode delivers pressure in the following sequence, repeating the sequence until the user exits the therapy or the number of cycles are complete:</p> <ol style="list-style-type: none"><li>1. If Pre-Therapy Breaths are enabled, the following sequence is repeated until the user exits therapy or the number of pre-therapy breaths requested is complete:<ol style="list-style-type: none"><li>a. Positive pressure at the Pre-Therapy Pressure setting for the duration of the Pre-Therapy Time setting.</li><li>b. Atmospheric pressure for the duration of the Pre-Therapy Pause setting.</li></ol></li><li>2. The next sequence is repeated until the user exits therapy or the number of coughs are complete:<ol style="list-style-type: none"><li>a. Positive pressure at the Inhale Pressure setting for the duration of the Inhale Time setting.</li><li>b. Negative pressure at the Exhale Pressure setting for the duration of the Exhale Time setting.</li><li>c. Atmospheric pressure for the duration of the Pause Time setting.</li></ol></li></ol> <p>If a Post-Therapy Breath is enabled, an extra inhale phase (positive pressure at the Inhale Pressure setting for the duration of the Inhale Time setting) will be provided after the last pause phase of the last cough cycle.</p> <p>When the Cough-Trak feature is enabled, Advanced Auto mode delivers pressure in the following sequence, repeating the sequence until the user exits the therapy or the number of cycles are complete:</p>
---------------	---

Advanced Auto (continued)	<ol style="list-style-type: none"><li>1. If Pre-Therapy Breaths are enabled, the following sequence is repeated until the user exits therapy or the number of pre-therapy breaths requested is complete:<ol style="list-style-type: none"><li>a. Positive pressure at the Pre-Therapy Pressure setting when the device detects the patient's effort to inhale for the duration of the Pre-Therapy Time setting.</li><li>b. Atmospheric pressure until the device detects the next inspiratory effort.</li></ol></li><li>2. The next sequence is repeated until the user exits therapy or the number of coughs are complete:<ol style="list-style-type: none"><li>a. Positive pressure at the Inhale Pressure setting when the device detects the patient's effort to inhale for the duration of the Inhale Time setting.</li><li>b. Negative pressure at the Exhale Pressure Setting for the duration of the Exhale Time Setting.</li><li>c. Atmospheric pressure until the device detects the next inspiratory effort.</li></ol></li></ol> <p>The Cough-Trak feature is described in more detail later in this chapter.</p> <p>If a Post-Therapy Breath is enabled, an extra inhale phase (positive pressure at the Inhale Pressure setting for the duration of the Inhale Time setting) will be provided after the last pause phase of the last cough cycle.</p> <p>Refer to the following diagram for an illustration of Advanced Auto Mode.</p>
------------------------------	---

**THE ADVANCED AUTO MODE - EXAMPLE**

Cough-Trak	OFF
Pre-Therapy Breaths	4
Pre-Therapy Pressure	20 cmH <sub>2</sub> O
Pre-Therapy Flow	Low
Pre-Therapy Time	2 sec.
Number of Coughs	4
Inhale Pressure	40 cmH <sub>2</sub> O
Inhale Flow	Medium
Inhale Time	2 sec.
Exhale Pressure	-40 cmH <sub>2</sub> O
Exhale Time	2 sec.
Oscillation	OFF
Number of Cycles	3
Post-Therapy Breath	ON

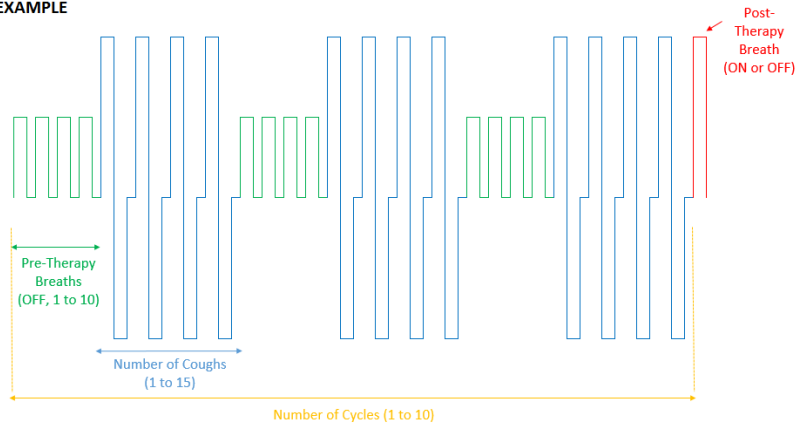

## 2.2 Therapy Features

If prescribed, the device provides the following therapy features.

### 2.2.1 Cough-Trak

An important characteristic of the device is its ability to trigger on the patient's inspiration to help synchronize the therapy with the patient. This feature is known as Cough-Trak.

The Cough-Trak feature is available when the device is in Auto mode or Advanced Auto mode. The pressure delivery sequence is synchronized with the patient's effort to inhale.

When the Cough-Trak setting is activated in Auto mode or Advanced Auto mode, therapy starts in the Pause phase until patient effort is detected.

When Cough-Trak is enabled, the Pause Time and Pre-therapy Pause settings are disabled and the user cannot adjust them.

### 2.2.2 Oscillation

The Oscillation therapy feature delivers an oscillatory therapy based on Frequency and Amplitude settings. Use of the oscillation feature enhances mobilization and improves bronchial drainage. The oscillations will be least apparent to the patient with lower amplitude and higher frequency settings.

If the Oscillation setting is enabled, the user can choose to apply the oscillation to the Inhale, Exhale, or Both (inhale and exhale) phases. The Frequency and Amplitude settings can be changed as needed. In Advanced Auto mode, the oscillations will also be applied to any pre-therapy breaths (inhale only). See Chapter 4 for more details on the Oscillation, Frequency, and Amplitude settings.

### 2.2.3 Pre-Therapy Breaths

Pre- Therapy Breaths can be programmed to deliver before the cough treatment one or more insufflation breaths at a different pressure setting than the cough therapy, to promote air stacking, or to provide repeated cycles of thoracic expansion typically utilized in Active Cycle of Breathing Techniques (ACBT).

### 2.2.4 Post-Therapy Breath

The Post-Therapy Breath allows the clinician to end the CoughAssist therapy on a positive pressure, as opposed to a negative pressure – by delivering one additional insufflation at the very end of the treatment.



## 2.2.5 Manual Override

In the event of a transient airway obstruction caused by the mobilization of secretions during the use of Auto or Advanced Auto Mode, the Manual Override offers the clinician quick access to the Manual Mode to manually control the CoughAssist therapy to achieve the desired outcome.

## 3. Device Setup

Complete the following steps to set up your device.

### 3.1 Install the Air Filter

If the air filter is not already installed, insert it into the filter area on the back of the device as shown. Only use the Philips Respironics air filter supplied with the device.

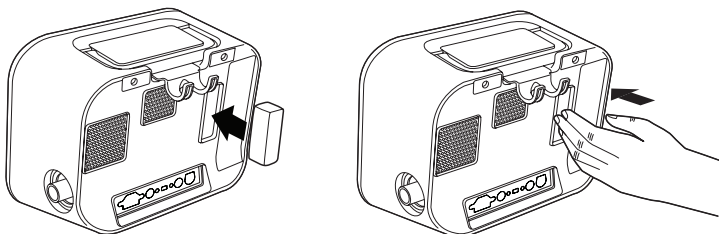

### 3.2 Position the Device Properly

Position the device on a firm, flat surface within easy reach of the patient or device operator. Make sure that the air inlet areas on the back and bottom of the device are not blocked. Air must flow freely around the device for the system to work properly.

### 3.3 Assemble the Patient circuit

1. Attach the appropriate patient interface to one end of the flexible tubing. Patient interface options include an adapter and face mask, mouthpiece, endotracheal tube, or tracheostomy tube.
2. Connect the other end of the flexible tubing to the bacteria filter.
3. Connect the bacteria filter inlet to the Patient Circuit Connection on the side of the device. A sample patient circuit assembly is shown below.

Note: Refer to the instructions included with the patient circuit for more information.

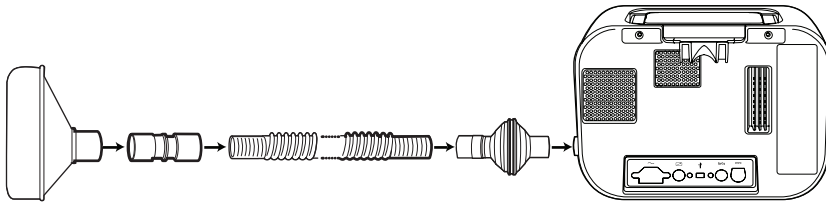

### 3.4 Supply Power to the Device

The device can operate on AC or DC power.

#### 3.4.1 Using AC Power

An AC power cord is included with the device.

1. Plug the socket end of the power cord into the AC inlet on the back of the device.
2. Plug the pronged end into an electrical outlet not connected to a wall switch.
3. Ensure that all connections are secure.

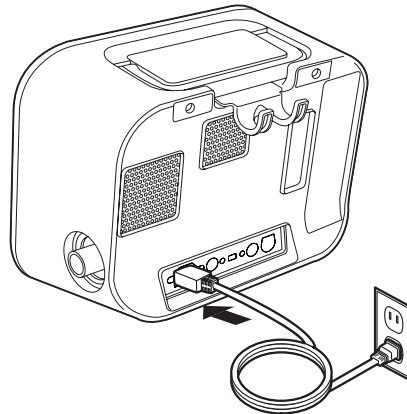

## 3.4.2 Using DC Power

You can operate the device using an external battery or the optional detachable battery. Note that the performance of the CoughAssist T70 while running on DC Power may be affected depending on the state of the battery, the therapy settings, and patient airway resistance.

### 3.4.2.1 External Battery

If you are using a 12 VDC deep cycle marine-type (lead acid) external battery, connect it to the DC power inlet on the back of the device using the Philips Respironics External Battery Cable. This cable is pre-wired and properly terminated to ensure safe connection of an external battery to the device. Battery operating time depends on the characteristics of the battery and usage of the device.

Due to a variety of factors, including battery chemistry, age, and use profile, the capacity of the external battery as shown on the device display is only an estimate of the actual remaining capacity.

Refer to the instructions supplied with the External Battery Cable for detailed information on how to operate the device using an external battery.

### 3.4.2.2 Detachable Battery

Philips Respironics offers a detachable Lithium-ion battery pack. To use the detachable battery pack, first remove the protective cover from the detachable battery pack compartment by following the instructions below.

1. Insert the tip of a screwdriver in the top of the battery cover to pry the cover from the device, as shown below.

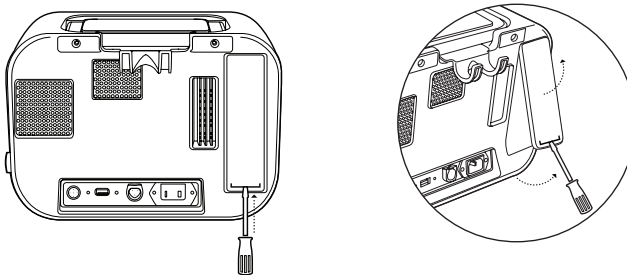

Refer to the instructions included with the Detachable Battery Pack for details on how to use the detachable battery with your device. You can also use the Philips Respironics Detachable Battery Charger to charge your detachable batteries. Refer to the instructions included with the Detachable Battery Charger for more details.

### 3.4.3 Device Power Source Indicators

Power source indicators are presented on the device and the display screen. These indicators are described in detail below.

#### 3.4.3.1 AC Power Indicators

When AC power is applied to the device and the airflow is off, the green AC LED indicator on the Power On/Power Off button lights. When AC power is applied and the airflow is on, the white AC LED indicator on the Power On/Power Off button lights. The LED turns off when the device is run on DC power.

#### 3.4.3.2 DC Power Indicators

When the external or detachable batteries are connected to the device, battery symbols will appear on-screen to indicate the battery status. The shading in the battery icon indicates the power remaining in the battery. Refer to the instructions supplied with your battery for more information.

## 3.5 Daily Use

### 3.5.1 Manual Mode

If Manual mode is selected in the software screens, complete the following steps (see Chapter 4 for more information on accessing Manual mode):

1. Attach the appropriate patient interface to the device.
2. Press the Power On/Power Off button to turn the device on and enter Standby.
3. Check your settings before starting therapy.
4. Attach the appropriate patient interface to the patient.
5. Press the Therapy button to start therapy.
6. Shift the Manual switch to the Inhale position, + (to the right) to insufflate.
7. Rapidly shift the Manual switch to the Exhale position, - (to the left) to exsufflate.
8. Leave the lever in the Pause (neutral) position for a few seconds, or shift immediately to the positive pressure phase for another cough cycle, depending on the patient's preference.

9. Go through as many cough cycles as determined by the clinician, until the patient is comfortable.
10. After the cycles are completed, disconnect the patient from the device, and clear secretions that may have become visible in the mouth, throat, tracheostomy tube, or endotracheal tube.
11. Repeat as advised by your clinician.

### 3.5.2 Auto Mode

If Auto mode is selected in the software screens, complete the following steps (see Chapter 4 for more information on how to access Auto mode):

1. Attach the appropriate patient interface to the device.
2. Press the Power On/Power Off button to turn the device on.
3. Check your settings before starting therapy.
4. Attach the appropriate patient interface to the patient.
5. Press the Therapy button to start therapy.
6. The device will automatically cycle from Inhale (positive) to Exhale (negative) to Pause (atmospheric pressure), and back to positive.
7. After the necessary cycles are completed, disconnect the patient from the device, and clear secretions that may have become visible in the mouth, throat, tracheostomy tube, or endotracheal tube.
8. Repeat as advised by your clinician.

### 3.5.3 Advanced Auto Mode:

If Advanced Auto mode is selected in the software screens, complete the following steps (see Chapter 4 for more information on how to access Advanced Auto mode):

1. Attach the appropriate patient interface to the device.
2. Press the Power On/Power Off button to turn the device on.
3. Check your settings before starting therapy.
4. Attach the appropriate patient interface to the patient.
5. Press the Therapy button to start therapy.

6. The device will automatically cycle between any pre-therapy breaths and the number of coughs [Inhale (positive) to Exhale (negative) to Pause (atmospheric pressure)] for the desired number of cycles, and end with a final post-therapy breath, if enabled.
7. After the therapy is complete, disconnect the patient from the device and clear secretions that may have become visible in the mouth, throat, tracheostomy tube, or endotracheal tube.
8. Repeat as advised by your clinician.

### 3.5.4 Preset Settings

When setting the device up for the patient, the health care professional can define up to three Preset settings. The health care professional can also limit the number of available presets for use. Presets allow the user to quickly select a group of prescribed settings to provide therapy. See Chapter 4 for more information on how to define the Preset settings.

## 4. Viewing and Changing Settings

### 4.1 Navigating the Menu Screens

To navigate through all of the menu screens and settings:

- Use the Up/Down button to scroll through the menu.
- Use the Left and Right buttons to perform the actions specified on the on-screen buttons.

#### 4.1.1 Screen Timeout Periods

The following timeout periods occur due to device inactivity:

- Monitor Screen - Has a timeout period of ten minutes when therapy is not being delivered. The timer restarts when a key is touched, the Manual switch is toggled in Manual Mode, or a patient effort is detected in Auto Mode when CoughTrak is enabled. When time expires, the device returns to the Standby screen.
- Standby Screen - Has a timeout period of ten minutes. The timer restarts when a key is touched or the Manual switch is toggled. When time expires, the screen turns off.
- Menu/Settings Screens - Any screen displaying a menu or log has a timeout period of five minutes. The timer restarts when a key is touched. When the timer expires, the action of the Left soft key is taken.
- Menu Items - Individual menu items on the Settings or Options screens have a timeout period of 30 seconds. The timer restarts when a key is touched. When the timer expires, the action of the Left soft key is taken.
- Confirmation Messages - Confirmation messages have a timeout period of 30 seconds. When time expires, the message is removed from the screen and the previous screen is displayed.



## 4.2 Accessing the Standby Screen

1. Press the  button, and the Startup screen appears momentarily, indicating the software version.
2. The Standby screen then appears, shown here. It displays the date and time, therapy mode, a patient accessory panel (if a patient accessory is attached), a status panel, and the soft key panel.
3. You can perform the following actions from the Standby screen :
  - a. If an accessory module is attached, you can monitor the connection to any attached patient accessory.
  - b. Modify patient settings by selecting the Left (Settings) key.
  - c. Access the menu by selecting the Up (Menu) key.
  - d. Initiate therapy by selecting the Right (Therapy) key. Selecting this key starts the airflow and displays the Monitoring screen.

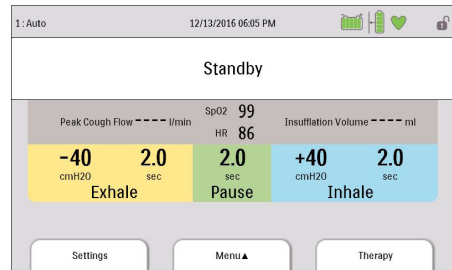

*Note: For descriptions of the information that appears on the Standby screen, see the Monitor Screen Content section of this chapter.*

## 4.3 Accessing the Monitor Screen

The Monitor screen appears after you press the Therapy key on the Standby screen. There are four versions of this screen:

- Manual/Auto Mode, Detailed View Off
- Manual/Auto Mode, Detailed View On
- Advanced Auto Mode, Detailed View Off
- Advanced Auto Mode, Detailed View On

Samples of all screens are shown below.

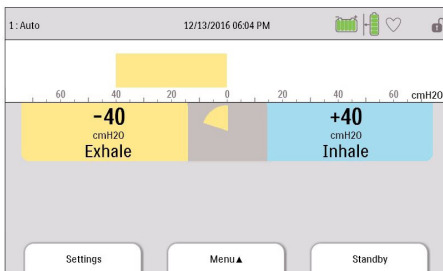

**Manual/Auto Mode, Detailed View Off**

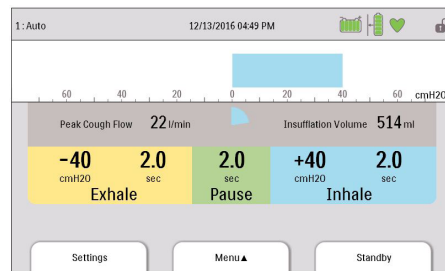

**Manual/Auto Mode, Detailed View On**

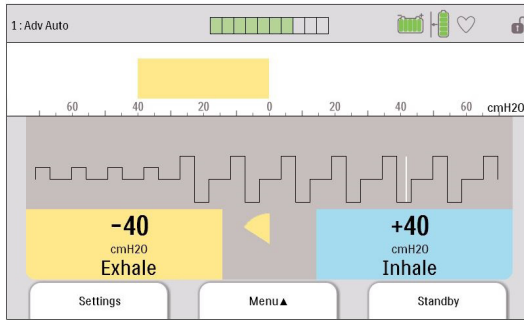

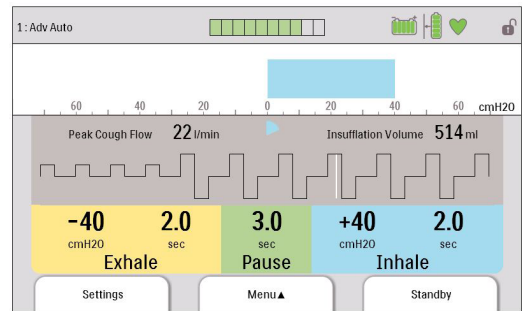

**Advanced Auto Mode, Detailed View Off**













**Advanced Auto Mode, Detailed View On**

### 4.3.1 Monitor Screen Content

The Monitor screen is divided into several sections, the Status panel, Manometer panel, Parameters panel, and the Soft buttons panel. The following information is shown on the Monitor screen:

Item/Description	Detailed View Off	Detailed View On
<b>Status Panel</b>		
<b>Preset Indicator:</b> Displays the number of the currently active preset of therapy settings (1, 2, or 3). Located in the top left corner of the screen.	√	√
<b>Mode Indicator:</b> Displays the current therapy mode. Located to the right of the Preset Indicator.	√	√
<b>Attribute Indicator:</b> Displays “Cough-Trak” or “Oscillation” when they are active. Located to the right of the Mode Indicator.	√	√
<b>Full Access (  ) Symbol:</b> Displays if full menu access is enabled. Located in the top right corner of the screen. If the menu access is Limited, this space is left blank.	√	√
<b>Informational Message (  ) Symbol:</b> Displays when there are Informational Messages in the Information Log.	√	√

Item/Description	Detailed View Off	Detailed View On
<b>Detachable Battery (  ) Symbol:</b> Displays if the detachable battery is connected. If no detachable battery is connected, this space is left blank. When the detachable battery is partially charged, some of the bars in the battery symbol will appear in green while others will be clear. For example, if the battery is 50% charged, the battery symbol will appear as (  ).	√	√
<b>External Battery (  ) Symbol:</b> Displays if an external battery is connected. If no external battery is connected, this space is left blank. When the external battery is partially charged, some of the bars in the battery symbol will appear in green while others will be clear. For example, if the battery is 50% charged, the battery symbol will appear as (  ).	√	√
<b>Remote Control (  ) Symbol:</b> Displays if a remote control (e.g., foot pedal) is connected. If no remote control is connected, this space is left blank.	√	√
<b>Pulse Oximeter (  ) Symbol:</b> Displays if a Pulse Oximeter is connected. Indicates the status of the Pulse Oximetry currently being received: Receiving good oximetry data: toggles between  and  Receiving questionable oximetry data: 	√	√
<b>SD Card (  ) Symbol:</b> Displays if an SD Card is inserted. If there is an error detected with the SD Card, displays the SD Card error icon (  ). If no SD Card is inserted, this space is left blank.	√	√
<b>Memory Card Writing (  ) Symbol:</b> Displays if data is being written to the SD Card.	√	√
<b>Power Source in Use Indicator (  ):</b> This indicator box is placed around the battery being used to power the device.	√	√

Item/Description	Detailed View Off	Detailed View On
<b>Charging Indicator</b> (  √	√	
<b>Number of Cycles Indication:</b> Displays an indication of the total number of cycles defined for the cough treatment and the number of cycles remaining. This replaces the time and date indication and is only displayed when the active prescription mode is <b>Advanced Auto</b> and therapy is being delivered.	√	√
<b>Date and Time Indication:</b> Displays the current date and time. Located at the center of the top of the screen. In Adv Auto mode, during therapy, date and time are not displayed.	√	√
<b>Manometer Panel</b>		
When the device is in the Monitoring screen, displays the pressure bar (Current Pressure) with pressure markings and pressure units. When the device is not providing therapy, this location is used to display messages and status.	√	√
<b>Parameters Panel</b>		
<b>Peak Cough Flow:</b> Displays the most recent measured peak cough flow. When the device is turned on, this parameter displays dashes in Standby before the first exhalation phase is completed. The Peak Cough Flow value displayed during pre-therapy breaths corresponds to the most recent peak expiratory flow measured during exhalation.		√
<b>SpO<sub>2</sub>:</b> Displayed only when the Pulse Oximeter accessory is connected to the device and the device is in Standby. Displays the current SpO <sub>2</sub> reading being received from the oximeter. If questionable or bad data is being received from the oximeter, displays dashes.		√

Item/Description	Detailed View Off	Detailed View On
<b>Heart Rate (HR):</b> Displayed only when the Pulse Oximeter accessory is connected to the device and the device is in Standby. Displays the current Heart Rate reading being received from the oximeter. If questionable or bad data is being received from the oximeter, displays dashes.		√
<b>Breath Synchronization Tool:</b> Displayed only when the active prescription mode is <b>Auto</b> or <b>Advanced Auto</b> . This gauge provides a visual indication of the remaining time for the active breath phase.	√	√
<b>Cough Treatment Synchronization Tool:</b> Displayed only when the active prescription mode is Advanced Auto. Graphically illustrates the programmed cough treatment, including pre-therapy breaths, number of coughs, and post-therapy breath.	√	√
<b>Insufflation Volume:</b> Displays the most recent delivered volume during insufflation. It is located above the Inhale data area. When the device is turned on, this parameter displays dashes in Standby before the first inhalation phase is completed. If the insufflation volume cannot be calculated, dashes are displayed.		√
<b>Exhale Pressure Setting:</b> Displays the current exhale pressure setting for the active prescription. It is located in the Exhale data area.	√	√
<b>Exhale Time Setting:</b> Displays the current exhale time setting for the active prescription when the mode is set to <b>Auto</b> or <b>Advanced Auto</b> . It is located in the Exhale data area.		√
<b>Exhale Time Counter:</b> Displays the actual time spent in the exhalation phase when the mode is set to <b>Manual</b> . This value counts up as the exhale time increases. It is located in the Exhale data area.		√
<b>Pause Time Setting:</b> Displays the current pause time setting for the active prescription when the mode is set to <b>Auto</b> or <b>Advanced Auto</b> . It is located in the Pause data area. If the mode is Manual, this area is left blank.		√

Item/Description	Detailed View Off	Detailed View On
<b>Inhale Pressure Setting:</b> Displays the current inhale pressure setting for the active prescription. It is located in the Inhale data area.	√	√
<b>Inhale Time Setting:</b> Displays the current inhale time setting for the active prescription when the mode is set to <b>Auto</b> or <b>Advanced Auto</b> . It is located in the Inhale data area.		√
<b>Inhale Time Counter:</b> Displays the actual time spent in the inhalation phase when the mode is set to <b>Manual</b> . This value counts up as the inhale time increases. It is located in the Inhale data area.		√
<b>Pre-Therapy Pressure Setting:</b> Displays the current pre-therapy inhale pressure setting for the active prescription, if the mode is set to Advanced Auto mode and pre-therapy breaths are active. It is located in the Inhale data area and is replaced by the Inhale Pressure Setting when the pre-therapy breaths are complete.	√	√
<b>Pre-Therapy Time Setting:</b> Displays the current pre-therapy inhale time setting for the active prescription, if the mode is set to Advanced Auto mode and pre-therapy breaths are active. It is located in the Inhale data area and is replaced by the Inhale Time Setting when the pre-therapy breaths are complete.		√
<b>Pre-Therapy Pause Setting:</b> Displays the current pre-therapy pause time setting for the active prescription, if the mode is set to Advanced Auto mode and pre-therapy breaths are active. It is located in the Pause data area and is replaced by the Pause Time Setting when the pre-therapy breaths are complete.		√

The Soft buttons panel appears at the bottom of the screen. The button selection varies depending on what screen is displayed.

## 4.4 Modifying Patient Therapy Settings

1. From the Standby or Monitor screen, select the Left key (Settings).

**Note:** The Settings key will not be available on the Monitor Screen when the device is set to Limited Access.

**Note:** Any setting changes that are made during therapy will automatically take effect at the beginning of that phase in the next cycle.

2. The following settings may appear on-screen, depending on how the device is configured.

**Note:** When the device is set to Limited Access and therapy is not being delivered, the only setting that appears on-screen is the Preset setting and users can select Presets 1, 2 or 3 – depending on how many presets are available, but not adjust any of the settings.

Setting	Description
Preset	Allows you to quickly select a group of predefined prescription settings (Presets 1, 2, or 3 – depending on how many presets are available). When the device is in Full Access mode, you can choose to alter the settings within each Preset by first selecting the Preset here and then adjusting each setting within that Preset accordingly.
Mode	Allows you to select Manual, Auto, or Advanced Auto mode.
Cough-Trak	Allows you to turn the Cough-Trak feature On or Off. Not available when mode is set to Manual.
Pre-Therapy Breath	Allows you to set the number of inhale breaths to be given prior to the start of therapy. This can be set to OFF, for no initial breaths, to up to 10 initial breaths. This is only available in Advanced Auto mode.
Pre-Therapy Pressure	Allows you to set the pressure provided during the initial Pre-Therapy Breaths from 0 – 70 cmH <sub>2</sub> O in increments of 1. This is only available in Advanced Auto mode and when 1 or more Pre-Therapy Breaths are requested.
Pre-Therapy Flow	Allows you to set the Pre-Therapy Flow setting for the initial Pre-Therapy Breaths to Low, Medium, or High. This is a comfort feature that allows you to control how rapidly the patient receives the Pre-Therapy Pressure delivered to them. This is only available in Advanced Auto Mode and when 1 or more Pre-Therapy Breaths are requested.

Pre-Therapy Time	Allows you to set the time of the inhale phase during the initial Pre-Therapy Breaths from 0.0 to 5.0 seconds in increments of 0.1. This is only available in Advanced Auto mode when 1 or more Pre-Therapy Breaths are requested.
Pre-Therapy Pause	Allows you to set the pause time between initial Pre-Therapy Breaths from 0.0 to 5.0 seconds in increments of 0.1. This is only available in Advanced Auto mode when 1 or more Pre-Therapy Breaths are requested and when Cough-Trak is not enabled.
Number of Coughs	Allows you to limit the number of coughs (insufflation, exsufflation, and pause) delivered during a cycle. This can be set for up to 15 coughs. When the number of coughs has completed, the device automatically begins the next cycle. This is only available in Advanced Auto mode.
Number of Cycles	Allows you to limit the number of cycles (pre-therapy breaths and coughs) delivered. This can be set for up to 10 cycles. When the number of cycles has completed, the device delivers the extra insufflation if the post-therapy breath has been enabled then automatically transitions to Standby. This is only available in Advanced Auto mode.
Post-Therapy Breath	Allows you to provide an extra insufflation at the completion of a set number of cycles. The Inhale Pressure, Inhale Flow, and Inhale Time settings are used to define this breath. This is only available in Advanced Auto Mode.
Inhale Pressure	Allows you to set the Inhale Pressure setting from 0 to 70 cmH <sub>2</sub> O in increments of 1. The Inhale Pressure is the pressure the patient receives while in the Inhale phase of the cough therapy.
Inhale Flow	Allows you to set the Inhale Flow setting to Low, Medium, or High. This is a comfort feature that allows you to control how rapidly the patient receives the Inhale Therapy delivered to them.
Inhale Time	Allows you to set the Inhale Time from 0.0 to 5.0 seconds in increments of 0.1. Inhale Time indicates how long the patient spends in the Inhale phase when in Auto mode. This setting is not available when the mode is set to Manual.
Exhale Pressure	Allows you to set the Exhale Pressure from 0 to -70 cmH <sub>2</sub> O in increments of 1. Exhale pressure is the pressure the patient receives while in the Exhale phase.



Exhale Time	Allows you to set the Exhale Time from 0.0 to 5.0 seconds in increments of 0.1. Exhale Time indicates how long the patient spends in the Exhale phase when in Auto mode. This setting is not available when the mode is set to Manual.
Pause Time	Allows you to set the Pause Time from 0.0 to 5.0 seconds in increments of 0.1. This setting is not available when the mode is set to Manual or when Cough-Trak is enabled in Auto Mode or Advanced Auto Mode.
Oscillation	Allows you to enable or disable the Oscillation feature. You can select Off to disable Oscillation, or select Inhale, Exhale, or Both when enabling Oscillation. Oscillation pulses the pressure delivered to the patient based on Frequency and Amplitude settings during the Inhale phase, Exhale phase, or both phases (depending on the setting you choose). Note that the available Oscillation setting may be limited based on the Pre-Therapy Pressure, Inhale Pressure, and/or Exhale Pressure settings.
Frequency	This setting only appears when Oscillation is enabled. It indicates how fast the pulses are delivered. You can set the Frequency from 1-20 Hz in increments of 1.
Amplitude	This setting only appears when Oscillation is enabled. It indicates how much the pulses vary from the pressure set point. You can set the Amplitude from 1 to 10 cmH <sub>2</sub> O in increments of 1. Note that the Amplitude is limited so that the delivered pressure during a pulse does not go beyond the valid limits of the pressure set point.

**Note:** The Pre-Therapy Inhale Pressure, Inhale Pressure, Exhale Pressure, Oscillation, and Amplitude settings work together in a way that ensures the pressure delivered to the patient will never be above 70 cmH<sub>2</sub>O or below 0 cmH<sub>2</sub>O during inhalation, and above 0 cmH<sub>2</sub>O and below -70 cmH<sub>2</sub>O during exhalation.

An example of the effect of the Oscillation setting is shown in the graph below. In this example, the Oscillation setting is **both**, the Amplitude setting is 10 cmH<sub>2</sub>O, and the Frequency setting is 10 Hz. The red line is the pressure with no oscillations applied. The blue line is the pressure waveform with the oscillations applied. The delivered pressure, based on the Amplitude setting, oscillates between 10 cmH<sub>2</sub>O above the pressure set point and 10 cmH<sub>2</sub>O below the pressure set point in both phases of the breath. Based on the Frequency setting, there will be 10 oscillations per second – giving the 20 oscillations performed in both the insufflation and exsufflation phase since they are both 2 seconds.

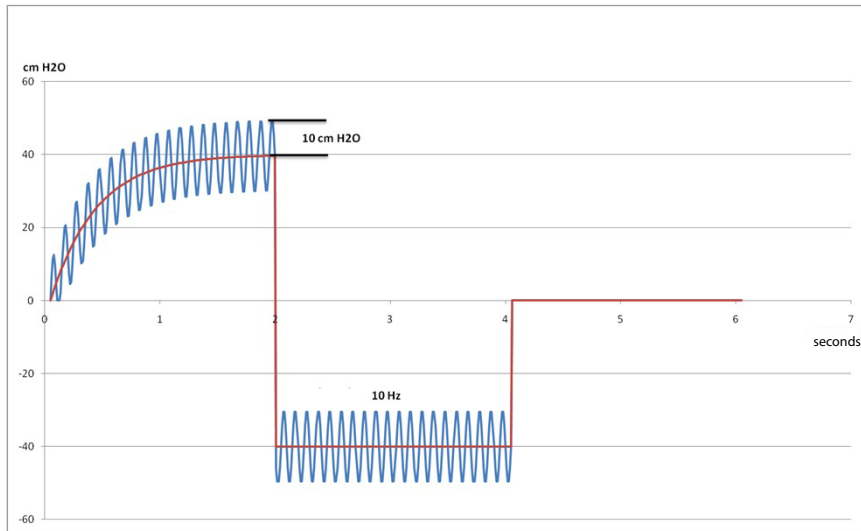

A graph of the pressure waveform is displayed to the right of the settings to help illustrate the effect of the parameter change being performed. The affected part of the waveform is displayed in green and the graph will dynamically change as the value is updated. An example of a parameter change is shown below.

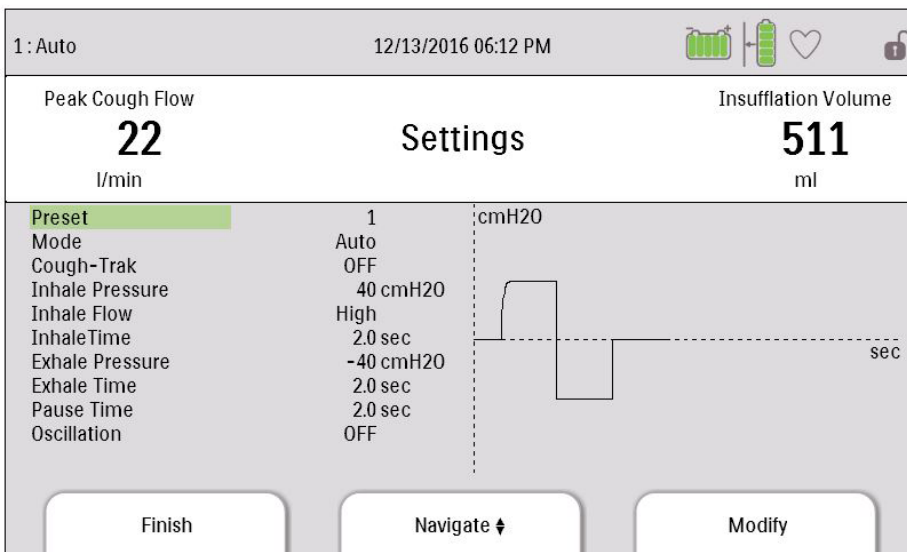

## 4.5 Changing Device Settings

1. Press the Up key to enter the Main Menu screen from the Standby or Monitor screens.
2. Choose from the following selections on the Main Menu screen:
  - Options: View and change device settings, such as Full or Limited Access mode, Detailed View, Language, etc.
  - Data: View patient and device data such as SpO<sub>2</sub>, Heart Rate, SD Card capacity, Therapy Hours, etc.
  - Information Log: View informational messages generated by the device.
  - Clear Patient Data: This option allows you to clear patient data from the device's internal memory. If an SD Card is inserted, all patient data stored on the SD Card is also cleared.
  - Safely Remove SD Card: This option will appear if an SD Card is inserted in the device. Select this option when you want to remove the SD Card. When the "Remove SD Card" confirmation message appears, remove the card. If you press the left (cancel) button or don't remove the card within 30 seconds, the confirmation message will close and the device will continue writing to the card.
  - Write Event Log to SD Card: This option allows you to copy event log data from the device to the SD Card.

### 4.5.1 Changing Options Menu Settings

1. From the Standby or Therapy screen, press the Menu key to enter the Main Menu.
2. Highlight Options on the Main Menu screen and press the Right soft key (Select).
3. The following settings appear on the Options screen when the device is in Full Access mode:

Setting	Description
Menu Access	Select Full or Limited menu access. Full menu access allows health care professionals and home care providers to access all device and prescription settings. Limited menu access allows users to access only certain settings and does not allow them to change prescription settings.
Detailed View	Turn Detailed View On or Off. Detailed View displays additional information on the Monitor screen.
Number of Presets	Limit the number of available presets. If a preset is made unavailable, its settings are reverted back to default values.
Language	Select the language in which the software will appear (English, French, German, etc).
Pressure Units	Select the pressure units that display on-screen. You can choose either cmH <sub>2</sub> O or hPa. All pressure units that appear on-screen display in the unit of measure selected here.
LCD Brightness	Select the brightness of the screen backlight from 1-10, with 1 being the dimmest setting and 10 being the brightest.
Date Format	Select either mm/dd/yyyy or dd/mm/yyyy as the date format that will display on the device screens.
Time Format	Select either an AM/PM time format (hh:mm AM) or 24 Hour time format (hh:mm). For example, 2:49PM or 14:49.
Month	The month defaults to the current month. The adjustable range is from 1 (January) to 12 (December).
Day	The day defaults to the current day. The adjustable range is from 1 to 31. The maximum value is based on the selected month.

Year	The year defaults to the current year. The adjustable range is from 2000-2069.
Hour	The hour defaults to the current hour. The adjustable range is from 12 AM to 12 PM or 0-23, depending on the selected Time Format.
Minute	The minute defaults to the current minute. The adjustable range is from 0-59.
Therapy Hours	This displays the total time the patient receives therapy. You can reset this value to zero.

When the device is in Limited Access mode, the following items appear on the Options screen:

- LCD Brightness
- Date Format
- Time Format
- Month
- Day
- Year
- Hour
- Minute

#### 4.5.2 Viewing Device Data

1. From the Main Menu, use the Up/Down key to highlight the Data item.
2. Press the Right soft key (Select) to select the Data item.

The Data screen provides a summary of the last measured patient data and device settings, shown below. You can use the Up/Down buttons to scroll through the information.

- SpO<sub>2</sub>
- HR (Heart Rate)
- Peak Cough Flow
- Insufflation Volume
- SD Card Capacity
- Serial Number
- Software Version
- Model Number

- Therapy Hours
- Calibration Date
- Detach Battery Serial Number
- Detach Battery Cycles

### 4.5.3 Viewing the Information Log

Whenever an informational message occurs while the device is running, the  icon will display at the top of the screen. This indicates that an informational message is available and the user should check the Information Log as soon as possible.

1. To access the Information Log, from the Main Menu, use the Up/Down key to highlight the Information Log item.
2. Press the Right soft key (Select) to select the Information Log item.

The information log lists all messages that have been generated while the device is in use.



## 5. Cleaning and Maintenance

### 5.1 Cleaning the Device

The device's exterior surface should be cleaned before and after each patient use and more often if needed.

1. Unplug the device and clean the front panel and exterior of the enclosure as needed using one of the following cleaning agents:
  - a. A clean cloth dampened with water and a mild detergent
  - b. 70% Isopropyl alcohol
  - c. DisCide Towelettes
  - d. 10% Chlorine bleach solution
2. Inspect the device and tubing for damage after cleaning. Replace any damaged parts.
3. Allow the device to dry completely before plugging in the power cord.

### 5.2 Cleaning and Replacing the Air Filter

Under normal usage, you should clean the air filter at least once every two weeks and replace it with a new one every six months.

1. If the device is operating, stop the airflow. Disconnect the device from the power source.
2. Remove the filter from the enclosure.
3. Examine the filter for cleanliness and integrity.
4. Wash the filter in warm water with a mild detergent. Rinse thoroughly to remove all detergent residue.



5. Allow the filter to air dry completely before reinstalling it. If the filter is torn or damaged, replace it. Only Philips Respironics-supplied filters should be used as replacement filters.
6. Reinstall the filter.

## 5.3 Cleaning the Patient Circuit

**WARNING:** *Do not attempt to sterilize the patient circuit. Always use a new bacteria filter when using the device on a new patient.*

### 5.3.1 Institutional (Hospital) Use

- **Patient Circuit: Breathing Hose, Patient Interface and Adapters:**  
If the device is to be used by more than one patient, the circuit must be replaced.
- **Bacteria Filter:**  
If the device is to be used by more than one patient, the filter must be replaced to prevent cross contamination. Do not try to wash the filter.

### 5.3.2 Home (Individual) Use

- **Patient Circuit: Breathing Hose, Patient Interface and Adapters:**  
After use, the breathing hose and patient interface should be washed thoroughly with liquid dishwashing soap and water. These parts must completely air dry before reuse.
- **Bacteria Filter:**  
The filter, which protects the device from entraining foreign material from the patient, can be left in place as long as it is not blocked by sputum or trapped moisture. Do not try to wash the filter.

## 5.4 Preventive Maintenance

This device does not require routine servicing.

Refer to the CoughAssist T70 Service Manual for detailed service information.

## 6. Accessories

There are several accessories available for your device. Contact your home care provider for additional information. When using the accessories, always follow the instructions included with them.

### 6.1 SD Card

The system comes with an SD Card inserted in the SD Card slot on the side of the device to record information for the home care provider. Your provider may ask you to periodically remove the SD Card and send it to them for evaluation.

To remove the SD Card:

1. Select the “Safely Remove SD Card” option from the main menu
2. After the “Remove SD Card” message appears, remove the card.

To write an Event Log to the SD Card:

1. Access the Standby screen in Full Menu Access mode.
2. Select the “Write Event Log to SD Card” option from the main menu.
  - a. While writing is in progress, the message “Writing in Progress” appears.
  - b. When writing is complete, the message “Writing Successful” appears.
  - c. If the write could not happen, the message “Writing Failed” appears.

**Note:** The SD Card does not need to be installed for the device to work properly.

**Note:** Use only SD Cards available from Philips Respironics.

## 6.2 Oximetry Cable

You can connect the recommended oximetry cable to the device to monitor SpO<sub>2</sub> and heart rate levels. When an oximeter is connected, the device displays the Oximeter's status when in Standby. When an oximeter is connected and the device is in Standby, the current SpO<sub>2</sub> and Heart Rate readings display on-screen. If bad data is being read from the oximeter, dashes appear next to the SpO<sub>2</sub> and Heart Rate indicators. See the instructions included with the oximetry cable for more information.

## 6.3 Foot Pedal

You can use the Foot Pedal accessory to initiate manual therapy. The Foot Pedal can be connected to the Remote Control Connector on the back of the CoughAssist T70. Both the Foot Pedal and Manual switch can be used during manual therapy. See the instructions included with the Foot Pedal for more information.

## 6.4 Carrying Case

A carrying case is available for transporting your device. When traveling, the carrying case is for carry-on luggage only. The carrying case will not protect the system if it is put through checked baggage.

## 6.5 Roll Stand

There is a roll stand available for use with your CoughAssist T70 device. See the instructions included with the roll stand for more information.

## 6.6 Supplemental Oxygen

The Philips Respironics CoughAssist 70 Series device is compatible with supplemental oxygen at flow rates not to exceed 30 liter per minute (lpm).

# 7. Troubleshooting

This chapter describes the informational messages that may appear on-screen and troubleshoots some of the problems you may experience with your device and possible solutions to those problems.

## 7.1 Informational Messages

The following informational messages may appear on-screen.

<b>Message</b>	<b>Description</b>
Battery Not Charging – Temp.	The detachable battery is too hot and cannot be charged. Allow device and/or battery to cool to resume charging. Remove battery and charge with battery charger accessory. If battery still cannot be charged, contact your home care provider.
Check External Battery	Power is being drawn from the detachable battery even though the external battery is usable. Replace external battery cable or external battery. If problem persists, contact your home care provider.
Detach Battery Not Charging	The detachable battery cannot be charged. Replace battery. If problem persists with a different battery, contact your home care provider.
Replace Detachable Battery	Detachable battery has failed or has reached end of life. Replace battery. If problem persists with a different battery, contact your home care provider.
Internal Fan Failure – See Manual	The internal fan is not working. Device should not be used with oxygen added to the patient circuit. Before using oxygen with this device, contact your home care provider.
Card Error	The device cannot write to or read from the SD Card. Remove the SD Card and use another card, if available. If problem persists, contact your home care provider.

## 7.2 Troubleshooting

**Question:** Why isn't my device turning on? The backlight on the buttons does not light.

**Answer:** If you are using AC power:

- Check the outlet and verify that the device is properly plugged in.
- Make sure there is power available at the outlet and that the AC power cord is connected correctly to the power supply and the power supply cord is securely connected to the device's power inlet.

If you are using an external power source:

- Make sure your DC power cord and battery adapter cable connections are secure.
- Check your battery. It may need recharged or replaced.
- If the problem persists, check the DC cord's fuse following the instructions supplied with your DC cord. The fuse may need to be replaced.

If you are using a detachable battery:

- Make sure the detachable battery is inserted into the back of the device correctly.
- Check your battery. It may need recharged or replaced.

If the problem continues, contact your home care provider for assistance.

**Question:** Why isn't the airflow turning on?

**Answer:** Make sure the device is powered correctly.

- Make sure you pressed the Therapy button on the display.
- If the problem continues, contact your home care provider for assistance.

**Question:** Why is the airflow much warmer than usual?

**Answer:** The air filters may be dirty. Clean or replace the air filters.

- The temperature of the air may vary somewhat based on your room temperature. Make sure the device is properly ventilated. Keep it away from bedding or curtains that could block the flow of air around the device.
- Make sure the device is away from direct sunlight and heating equipment.

**Question:** Why isn't my detachable battery charging when it is inserted into the device and the device is running on AC power?

**Answer:** The battery may not charge if the device is too hot or too cold or is operating at an ambient temperature outside of the specified valid range.

- Make sure the device is not too close to a heat source.
- Ensure the cooling air vents are not blocked.
- Bring the device to ambient room temperature.
- Use the optional Philips Respironics Detachable Battery Charger to charge your battery.
- If the problem continues, contact your home care provider for assistance.

**Question:** Why doesn't my manual switch or my foot pedal work?

**Answer:** Both the optional Foot Pedal and the manual switch work when therapy is active in Manual Mode. However, if one input method is active, the other is ignored until they are both in the inactive (pause) state. For example, if an inhale or exhale phase was started with the Foot Pedal, the manual switch will be ignored until the foot pedal and the manual switch are not in use and the therapy is in the Pause state.

- Make sure the Foot Pedal is connected (if the issue is with the foot pedal)
- Press the Therapy button to ensure that the therapy is on.
- Make sure the device is in manual mode.
- Make sure the Inhale and Exhale pressure values are not zero.
- Make sure the therapy is in Pause (foot pedal and manual switch are not in the Inhale or Exhale position)



## 8. Technical Specifications

### Environmental

	Operating	Storage
<b>Temperature</b>	41° F to 95° F (5° C to 35° C)	-4° F to 140° F (-20° C to 60° C)
<b>Relative Humidity</b>	15 to 95% (non-condensing)	15 to 95% (non-condensing)
<b>Atmospheric Pressure</b>	101 kPa to 77 kPa (approximately 0-2286 meters)	N/A

### Physical

Dimensions:	11.5" W x 9.1" H x 7.5" D (29.2 cm W x 23.1 cm H x 19.0 cm D)
Weight:	8.4 lbs (3.8 kg) (without detachable battery) 9.4 lbs (4.3 kg) (with detachable battery installed)

### Standards Compliance

This device is designed to conform to the following standards:

- IEC 60601-1: Medical electrical equipment - Part 1: General requirements for safety
- IEC 60601-1-2: General requirements for safety - Collateral standard: Electromagnetic compatibility - Requirements and tests
- ISO 10993-1 Biological evaluation of medical devices - Part 1: Evaluation and testing (Biocompatibility)
- RTCA/DO-160F section 21, category M; Emission of Radio Frequency Energy



## Electrical

AC Voltage Source:	100 to 240VAC, 50/60 Hz, 2A/1A
DC Power Source:	12 VDC, 8.3A
Type of Protection Against Electric Shock:	Class II
Degree of Protection Against Electric Shock:	Type BF Applied Part
Degree of Protection Against Ingress of Water:	Exposure Protection, IP22
Mode of Operation:	Continuous

## SD Card and SD Card Reader

Use only SD Cards and SD Card readers available from Philips Respironics, including the following:

SanDisk® Card Reader/Writer - SanDisk ImageMate - REF SDDR-99-A15

## Displayed Parameter Accuracy

Parameter	Accuracy	Resolution	Range
Pressure	> of $\pm 5$ cmH <sub>2</sub> O or 10% of reading	1 cmH <sub>2</sub> O	-70 to 70 cmH <sub>2</sub> O
Peak Cough Flow (PCF)	> of $\pm 15$ lpm or 15%	1 lpm	0-500 lpm
Insufflation Volume	$\pm (25 + 0.15$ of reading) for peak flows greater than or equal to 20 lpm	1 ml	50-2000 ml

Accuracies stated in this manual are based on specific environmental conditions. For stated accuracy, the environmental conditions are: Temperature: 20-30° C; Humidity: 50% relative; Altitude: nominally 380 meters.

## Control Accuracy

Parameter	Range	Accuracy
Pressure	-70 to 70 cmH <sub>2</sub> O	± 5 cmH <sub>2</sub> O
Inhale Time	0-5 seconds	± (10% of setting + 0.1 second)
Exhale Time	0-5 seconds	± (10% of setting + 0.1 second)
Pause Time	0-5 seconds	± (10% of setting + 0.1 second)
Pre-Therapy Breath Time	0 – 5 seconds	± (10% of setting + 0.1 seconds)
Pre-Therapy Breath Pause	0 – 5 seconds	± (10% of setting + 0.1 seconds)
Frequency	1-20 Hz	± (10% of setting)
Amplitude	1-10 cmH <sub>2</sub> O	± 5 cmH <sub>2</sub> O

Device performance and accuracy is specified at Temperature: 20-30° C; Humidity: 50% relative; Altitude: nominally 380 meters for typical patients.

## Sound

The sound pressure of the device set at -40 cmH<sub>2</sub>O/+40 cmH<sub>2</sub>O in the Pause phase is less than 62 dBA at 1 meter.

## Disposal

Dispose of the device in accordance with local regulations.



# CoughAssist T70 user manual

## 9. EMC Information

**Note:** The Essential Performance of the CoughAssist T70 Series Device is defined as follows to provide the therapy function as described in the “Intended Use” section and the following specifications:

- Inhale Pressure not to exceed 85 cmH<sub>2</sub>O for 1 minute
- Exhale Pressure not to exceed -75 cmH<sub>2</sub>O
- Duration of inhale phase in Auto Mode within  $\pm(10\%$  of the setting + 0.1 seconds)
- Duration of exhale phase in Auto Mode within  $\pm(10\%$  of the setting + 0.1 seconds)
- All breath phases with times > 0 occurring in proper order in Auto Mode

If this essential performance cannot be delivered, the device will either reboot or generate a Device Inoperative condition to prevent harm to the patient.

### Guidance and Manufacturer’s Declaration - Electromagnetic Emissions

This device is intended for use in the electromagnetic environment specified below. The user of this device should make sure it is used in such an environment.

Emissions Test	Compliance	Electromagnetic Environment - Guidance
RF emissions CISPR 11	Group 1	The device uses RF energy only for its internal function. Therefore, its RF emissions are very low and are not likely to cause any interference in nearby electronic equipment.
RF emissions CISPR 11	Class B	The device is suitable for use in all establishments, including domestic establishments and those directly connected to the public low-voltage power supply network that supplies building used for domestic purpose.
Harmonic emissions IEC 61000-3-2	Class A	
Voltage fluctuations/Flicker emissions IEC 61000-3-3	Complies	

## Guidance and Manufacturer's Declaration - Electromagnetic Immunity

This device is intended for use in the electromagnetic environment specified below. The user of this device should make sure it is used in such an environment.

Immunity Test	IEC 60601 Test Level	Compliance Level	Electromagnetic Environment - Guidance
Electrostatic Discharge (ESD) IEC 61000-4-2	±8 kV contact ±2 kV, ±4 kV, ±8 kV, & ±15 kV air	±8 kV contact ±2 kV, ±4 kV, ±8 kV, & ±15 kV air	Floors should be wood, concrete or ceramic tile. If floors are covered with synthetic material, the relative humidity should be at least 35%.
Electrical fast Transient/burst IEC 61000-4-4	±2 kV for power supply lines ±1 kV for input-output lines	±2 kV for Power Supply Lines NA - Device does not have user I/O lines that are longer than 3m in length.	Mains power quality should be that of a typical home or hospital environment.
Surge IEC 61000-4-5	±1 kV Line to Line ±2 kV Line to Ground	±1 kV Line to Line NA - The device is a Class II device and does not connect to earth ground.	Mains power quality should be that of a typical home or hospital environment.
Voltage dips, short interruptions and voltage variations on power supply input lines IEC 61000-4-11	0% UT 0.5 cycle, 45 deg inc 0% UT 1 cycle 70% UT 25 cycles (30 cycles if US) 0% UT 5 sec	0% UT 0.5 cycle, 45 deg inc 0% UT 1 cycle 70% UT 25 cycles (30 cycles if US) 0% UT 5 sec	Mains power quality should be that of a typical home or hospital environment. If the user of the device requires continued operation during power mains interruptions, it is recommended that the device be powered from an uninterruptible power supply or a battery.
Power frequency (50/60 Hz) magnetic field IEC 61000-4-8	30 A/m	30 A/m	Power frequency magnetic fields should be at levels characteristic of a typical home or hospital environment.
NOTE: $U_T$ is the a.c. mains voltage prior to application of the test level.			

## Guidance and Manufacturer's Declaration - Electromagnetic Immunity

This device is intended for use in the electromagnetic environment specified below. The user of this device should make sure it is used in such an environment.

Immunity Test	IEC 60601 Test Level	Compliance Level	Electromagnetic Environment - Guidance
Conducted RF IEC 61000-4-6	3 V 150 kHz to 80 MHz	3 V	Portable and mobile RF communications equipment should be used no closer to any part of the device, including cables, than the recommended separation distance.  <b>Recommended separation distance:</b> Minimum 30 cm (12 inches)
	6 V in ISM & amateur radio bands between 150 kHz and 80 MHz	6 V	
Radiated RF IEC 61000-4-3	10 V/m 80 MHz to 2.7 GHz	10 V/m	Interference may occur in the vicinity of equipment marked with the following symbol: 
	Telecommunication frequencies as specified in clause 8.10 of IEC 60601-1-2:2014		
	450, 810, 870, 930, 1720, 1845, 1970, and 2450 MHz at 28 V/m	28 V/m	
	385 MHz at 27 V/m	27 V/m	
	710, 745, 780, 5240, 5500, and 5785 MHz at 9 V/m	9 V/m	



# CoughAssist T70

## user manual

# Limited Warranty

Respironics, Inc. warrants that the **CoughAssist T70** system shall be free from defects of workmanship and materials and will perform in accordance with the product specifications for a period of one (1) year from the date of sale by Respironics, Inc. to the dealer. If the product fails to perform in accordance with the product specifications, Respironics, Inc. will repair or replace – at its option – the defective material or part. Respironics, Inc. will pay customary freight charges from Respironics, Inc. to the dealer location only. This warranty does not cover damage caused by accident, misuse, abuse, alteration, and other defects not related to material or workmanship, including, without limitation, damage resulting from failure to use a bacterial filter with the device in accordance with the specifications.

Respironics, Inc. disclaims all liability for economic loss, loss of profits, overhead, or consequential damages which may be claimed to arise from any sale or use of this product. Some states do not allow the exclusion or limitation of incidental or consequential damages, so the above limitation or exclusion may not apply to you.

Accessories and replacement parts, including, but not limited to, circuits, tubing, leak devices, exhaust valves, filters and fuses, are not covered under this warranty.

This warranty is given in lieu of all other express warranties. In addition, any implied warranties – including any warranty of merchantability or fitness for the particular purpose – are limited to one year. Some states do not allow limitations on how long an implied warranty lasts, so the above limitation may not apply to you. This warranty gives you specific legal rights, and you may also have other rights which vary from state to state.

To exercise your rights under this warranty, contact your local authorized Respironics, Inc. dealer or contact Respironics, Inc. at:

1001 Murry Ridge Lane  
Murrysville, Pennsylvania 15668-8550  
1-724-387-4000



