

800

Operator's and Technical Reference Manual

Series Ventilator System



Part No. 4-075609-00
Rev. M
August 2010

Copyright Information

Copyright 2010 Nellcor Puritan Bennett LLC. All rights reserved. The Puritan Bennett™ 840 Ventilator System is manufactured in accordance with Nellcor Puritan Bennett LLC proprietary information, covered by one or more of the following U.S. Patents and foreign equivalents: 5,271,389; 5,319,540; 5,339,807; 5,390,666; 5,771,884; 5,791,339; 5,813,399; 5,865,168; 5,881,723; 5,884,623; 5,915,379; 5,915,380; 6,024,089; 6,161,539; 6,220,245; 6,269,812; 6,305,373; 6,360,745; 6,369,838; 6,553,991; 6,668,824; 6,675,801; 7,036,504; 7,117,438; and RE39225. *840*, *800 Series*, *DualView*, *SandBox*, *SmartAlert*, *Flow-by*, and *PTS 2000* are trademarks of Nellcor Puritan Bennett LLC and used under license.

The information contained in this manual is the sole property of Nellcor Puritan Bennett LLC and may not be duplicated without permission. This manual may be revised or replaced by Nellcor Puritan Bennett LLC at any time and without notice.

You should ensure you have the most current applicable version of this manual; if in doubt, contact Nellcor Puritan Bennett LLC or visit the Puritan Bennett product manual web page at:

<http://www.puritanbennett.com/serv/manuals.aspx>

While the information set forth herein is believed to be accurate, it is not a substitute for the exercise of professional judgment.

The ventilator should be operated and serviced only by trained professionals. Nellcor Puritan Bennett's sole responsibility with respect to the ventilator, and its use, is as stated in the limited warranty provided.

Nothing in this manual shall limit or restrict in any way Nellcor Puritan Bennett's right to revise or otherwise change or modify the equipment (including its software) described herein, without notice. In the absence of an express, written agreement to the contrary, Nellcor Puritan Bennett LLC has no obligation to furnish any such revisions, changes, or modifications to the owner or user of the equipment (including its software) described herein.

Rx ONLY

Applicability

The information in this manual applies to Puritan Bennett 840 ventilator versions manufactured or updated after August 2005. Some of this information may not apply to earlier versions. Contact your Puritan Bennett representative if in doubt.

Definitions

This manual uses three special indicators to convey information of a specific nature. They include:

Warning

Indicates a condition that can endanger the patient or the ventilator operator.

Caution

Indicates a condition that can damage the equipment.

NOTE:

Indicates points of particular emphasis that make operation of the ventilator more efficient or convenient.

Warnings, cautions, and notes

Please take the time to familiarize yourself with the following safety considerations, special handling requirements, and regulations that govern the use of the Puritan Bennett 840 Ventilator System.

- To ensure proper servicing and avoid the possibility of physical injury, only qualified personnel should attempt to service or make authorized modifications to the ventilator.

The user of this product shall have sole responsibility for any ventilator malfunction due to operation or maintenance performed by anyone not trained by Puritan Bennett.

- To avoid an electrical shock hazard while servicing the ventilator, be sure to remove all power to the ventilator by disconnecting the power source and turning off all ventilator power switches.
- To avoid a fire hazard, keep matches, lighted cigarettes, and all other sources of ignition (e.g., flammable anesthetics and/or heaters) away from the Puritan Bennett 840 Ventilator System and oxygen hoses.

Do not use oxygen hoses that are worn, frayed, or contaminated by combustible materials such as grease or oils. Textiles, oils, and other combustibles are easily ignited and burn with great intensity in air enriched with oxygen.

In case of fire or a burning smell, immediately disconnect the ventilator from the oxygen supply, facility power, and backup power source.

- When handling any part of the Puritan Bennett 840 Ventilator System, always follow your hospital infection control guidelines for handling infectious material.

Puritan Bennett recognizes cleaning, sterilization, sanitation, and disinfection practices vary widely among health care institutions. It is not possible for Puritan Bennett to specify or require specific practices that will meet all needs, or to be responsible for the effectiveness of cleaning, sterilization, and other practices carried out in the patient care setting. As a manufacturer Puritan Bennett does not have any guidelines or recommendations regarding specific pathogens as they relate

to the usage of our products. In regards to transmission of any specific pathogen, Puritan Bennett can offer the specifications of our products as well as our recommendations for cleaning and sterilization. Any further clarification regarding pathogens as they relate to our products should be brought to the attention of your lab Pathologist as well as your infection control personnel and/or risk committee.

- Patients on life-support equipment should be appropriately monitored by competent medical personnel and suitable monitoring devices.

The Puritan Bennett 840 Ventilator System is not intended to be a comprehensive monitoring device and does not activate alarms for all types of dangerous conditions for patients on life-support equipment.

- For a thorough understanding of ventilator operations, be sure to thoroughly read this manual before attempting to use the system.
- Before activating any part of the ventilator, be sure to check the equipment for proper operation and, if appropriate, run SST as described in this manual.
- Do not use sharp objects to make selections on the graphic user interface (GUI) display or keyboard.
- US federal law restricts this device to sale by or on the order of a physician.
- Check the ventilator periodically as outlined in the *Puritan Bennett 800 Series Ventilator System Service Manual*; do not use if defective. Immediately replace parts that are broken, missing, obviously worn, distorted, or contaminated.
- An alternative source of ventilation should always be available when using the Puritan Bennett 840 Ventilator System.
- This ventilator offers a choice of breath delivery modes and types. Throughout the patient's treatment, the clinician should carefully select the ventilation mode and/or breath type to use for that patient. This selection should be based on the clinician's clinical judgment, considering the condition and needs of the individual patient, as such condition and needs change from time to time, and considering the benefits,

limitations and operating characteristics of each mode and/or breath type.

Warranty

The Puritan Bennett 840 Ventilator System is warranted against defects in material and workmanship in accordance with the Puritan Bennett Medical Equipment Warranty supplied with your ventilator. Keep a maintenance record to ensure the validity of the warranty.

Year of manufacture

The graphic user interface (GUI), breath delivery unit (BDU), backup power source (BPS), and compressor contain a specific year of manufacture applicable only for that assembly. The year of manufacture is indicated by the fifth and sixth digits of the serial number which is located at the back panel of the GUI, BDU, and BPS, and the side panel of the compressor.

Manufacturer

Tyco Healthcare Group LP
Nellcor Puritan Bennett Division
4280 Hacienda Drive
Pleasanton, CA 94588-2719
USA

Electromagnetic susceptibility

The Puritan Bennett 840 Ventilator System complies with the requirements of IEC 60601-1-2:2004 (EMC Collateral Standard), including the E-field susceptibility requirements at a level of 10 volts per meter, at frequencies from 80 MHz to 2.5 GHz, and the ESD requirements of this standard.

However, even at this level of device immunity, certain transmitting devices (cellular phones, walkie-talkies, cordless phones, paging transmitters, etc.) emit radio frequencies that could interrupt ventilator operation if operated in a range too close to the ventilator. It is difficult to determine when the field strength of these devices becomes excessive.

Practitioners should be aware radio frequency emissions are additive, and the ventilator must be located a sufficient distance from transmitting devices to avoid interruption. Do not operate the ventilator in a magnetic resonance imaging (MRI) environment.

Warning

Accessory equipment connected to the power receptacle, analog, and digital interfaces must be certified according to IEC 60601-1. Furthermore, all configurations shall comply with the system standard IEC 60601-1-1. Any person who connects additional equipment to the power receptacle, signal input part, or signal output part of the Puritan Bennett 840 ventilator configures a medical system, and is therefore responsible for ensuring the system complies with the requirements of the system standard IEC 60601-1-1. If in doubt, consult Puritan Bennett Technical Services at 1.800.255.6774 or your local representative.

This manual describes possible ventilator alarms and what to do if they occur. Consult with your institution's biomedical engineering department in case of interrupted ventilator operation, and before relocating any life support equipment.

Customer assistance

For further assistance call Puritan Bennett Technical Services at 1.800.255.6774 or contact your local Puritan Bennett representative.



SolvITSM
C E N T E R
Knowledge base

For online technical support, visit the SolvITSM Center Knowledge Base at <http://www.puritanbennett.com>

The SolvIT Center provides answers to frequently asked questions about the Puritan Bennett 840 Ventilator System and other Puritan Bennett products 24 hours a day, 7 days a week.

Preface

This manual is divided into two parts: the operator's manual and the technical reference. The operator's manual describes how to operate the Puritan Bennett 840 Ventilator System. It also provides product specifications and accessory order numbers. The technical reference includes background information about how the ventilator functions, including details on its operating modes, self-tests, and other features. In the table of contents and index, the prefix OP- identifies page numbers in the operator's manual, and the prefix TR- identifies page numbers in the technical reference.

Any references to the software options *BiLevel*[®], *Volume Ventilation Plus*[®] (VV+) which includes VC+ and VS breath types, *NeoMode*[®], *Proportional Assist Ventilation*[®] (PAV+), *Tube Compensation (TC)*, *Respiratory Mechanics (RM)*, and *Trending* in this manual assume that the option has been installed on the ventilator. If these options aren't installed, then references to their functions do not apply.

While this manual covers the ventilator configurations currently supported by Puritan Bennett, it may not be all-inclusive and may not be applicable to your ventilator. Within the USA, contact Puritan Bennett at 1.800.255.6774 for questions about the applicability of the information.

Some illustrations and images are shown with a ready-to-assemble (RTA) cart, Puritan Bennett 800 Series Ventilator Compressor

Mount Cart, or a Puritan Bennett 800 Series Ventilator Pole Cart. Please note that these images are for illustrative purposes only, and regardless of which cart you have, the required information is provided.

The term “RTA cart” refers to the ready-to-assemble cart and any earlier cart versions.

Operator's Manual

1 Introduction	OP 1-1
1.1 Technical description	OP 1-3
1.1.1 General background	OP 1-3
1.1.2 Pressure and flow triggering	OP 1-5
1.1.3 Breathing gas mixture	OP 1-5
1.1.4 Inspiratory pneumatics	OP 1-6
1.1.5 Patient circuit	OP 1-6
1.1.6 AC mains and backup power system	OP 1-7
1.1.7 Ventilator emergency states.	OP 1-8
1.2 Graphic user interface	OP 1-9
1.3 User interface controls and indicators	OP 1-11
1.3.1 Onscreen symbols and abbreviations.	OP 1-17
1.4 Ventilator system labeling symbols.	OP 1-22
2 How to set up the Puritan Bennett 840 ventilator	OP 2-1
2.1 How to connect the electrical supply	OP 2-4
2.2 How to connect the air and oxygen supplies	OP 2-12
2.3 How to connect the patient circuit components	OP 2-14
2.3.1 How to select and connect a patient circuit	OP 2-15
2.3.2 How to install the expiratory filter and collector vial.	OP 2-18
2.3.3 How to install the flex arm.	OP 2-21
2.3.4 How to install the humidifier	OP 2-24
2.3.5 How to use the ventilator cart	OP 2-26
3 How to run Short Self Test (SST)	OP 3-1
3.1 Introduction to SST	OP 3-1
3.2 When to run SST	OP 3-2
3.3 SST components and requirements	OP 3-4
3.4 SST Procedure	OP 3-5
3.5 SST Results.	OP 3-14
3.5.1 How to interpret individual SST test results	OP 3-15

Contents

3.5.2 SST outcomes OP 3-16

4 How to use the Puritan Bennett 840 ventilator **OP 4-1**

- 4.1 Structure of user interface OP 4-2
- 4.2 Patient setup. OP 4-3
 - 4.2.1 How to ventilate with most recent control parameters OP 4-4
 - 4.2.2 How to ventilate with new control parameters . . OP 4-4
 - 4.2.3 Patient data and current settings. OP 4-8
 - 4.2.4 Ideal Body Weight (IBW) OP 4-11
- 4.3 How to change the main ventilator control parameters OP 4-16
- 4.4 Ideal Body Weight (IBW), vent type, mode, and other changes OP 4-17
- 4.5 How to select a constant timing variable during respiratory rate changes OP 4-19
- 4.6 How to change apnea ventilation settings. OP 4-21
- 4.7 How to set alarms OP 4-22
- 4.8 How to change other settings OP 4-23
- 4.9 Expiratory pause maneuvers OP 4-25
- 4.10 Inspiratory pause maneuvers OP 4-26
- 4.11 How to interpret inspiratory pause maneuver results for static compliance and resistance OP 4-28
- 4.12 How to use NIV. OP 4-29
 - 4.12.1 NIV intended use OP 4-29
 - 4.12.2 NIV breathing interfaces OP 4-29
 - 4.12.3 NIV setup OP 4-30
 - 4.12.4 High spontaneous inspiratory time limit setting. OP 4-34
 - 4.12.5 Apnea setup OP 4-34
 - 4.12.6 Alarm setup. OP 4-35
 - 4.12.7 Changing patient from INVASIVE to NIV Vent Type OP 4-36
 - 4.12.8 Changing patient from NIV to INVASIVE Vent Type OP 4-37
 - 4.12.9 NIV patient data OP 4-38

5 How to handle alarms	OP 5-1
5.1 Ventilator alarm classifications	OP 5-1
5.2 Alarm silence	OP 5-2
5.3 Alarm reset	OP 5-4
5.4 Alarm log.	OP 5-5
5.5 Alarm volume	OP 5-6
5.6 Alarm messages	OP 5-7
6 How to view graphics	OP 6-1
6.1 Graphics display function.	OP 6-1
6.2 How to set up a graphics display	OP 6-3
6.3 Graphics display details and calculations	OP 6-4
6.4 How to adjust displayed graphics.	OP 6-5
6.5 The graphics display FREEZE function	OP 6-5
6.6 How to print patient data graphics	OP 6-7
6.7 Automatic display of graphics	OP 6-7
6.8 When graphics are not accessible	OP 6-8
7 Preventive maintenance	OP 7-1
7.1 How to dispose of used parts.	OP 7-1
7.2 How to clean, disinfect and sterilize parts.	OP 7-2
7.2.1 How to clean components.	OP 7-6
7.3 Disinfection and sterilization	OP 7-6
7.4 Preventive maintenance procedures for the operator.	OP 7-8
7.4.1 Total operational hours	OP 7-9
7.4.2 Inspiratory and expiratory bacteria filters	OP 7-12
7.4.3 Daily or as required: collector vial and drain bag	OP 7-14
7.4.3.1 How to remove the collector vial	OP 7-14
7.4.3.2 How to remove the drain bag	OP 7-15
7.4.4 Daily or as required: in-line water traps	OP 7-16
7.4.5 Every 250 hours: compressor inlet filter	OP 7-16
7.4.6 Every year: ventilator inspection.	OP 7-17
7.4.6.1 Every year or as necessary: oxygen sensor	OP 7-17
7.4.6.2 Oxygen sensor replacement procedure	OP 7-19
7.5 Additional preventive maintenance procedures	OP 7-25

Contents

7.6 Storage	OP 7-27
7.7 Repacking and shipping	OP 7-27

A Specifications **OP A-1**

A.1 Physical characteristics	OP A-2
A.2 Environmental requirements	OP A-6
A.3 Pneumatic specifications	OP A-6
A.4 Electrical specifications	OP A-8
A.5 Compliance and approvals	OP A-12
A.5.1 Manufacturer's Declaration	OP A-13
A.6 Technical specifications	OP A-21
A.7 Ranges, resolutions, and accuracies	OP A-28
A.7.1 Recommended limits	OP A-28
A.7.2 Software options	OP A-29

B Part numbers **OP B-1**

C Pneumatic schematic **OP C-1**

D Alarm and oxygen sensor calibration testing **OP D-1**

D.1 Alarm test	OP D-1
D.2 Oxygen sensor calibration test	OP D-8

E Remote alarm and RS-232 ports **OP E-1**

E.1 Remote alarm port	OP E-2
E.2 RS-232 port	OP E-3
E.3 How to configure the RS-232 ports	OP E-4
E.4 Printers and cables	OP E-5
E.5 RS-232 port commands	OP E-6

Technical Reference

1 Introduction to breath delivery	TR 1-1
2 Detecting and initiating inspiration	TR 2-1
2.1 Internally triggered inspiration	TR 2-2
2.1.1 Pressure sensitivity	TR 2-2
2.1.2 Flow sensitivity	TR 2-3
2.1.3 Time-cycled inspiration	TR 2-5
2.2 Operator-triggered inspiration	TR 2-6
3 Detecting and initiating exhalation	TR 3-1
3.1 Internally initiated exhalation	TR 3-1
3.1.1 Time-cycled exhalation	TR 3-1
3.1.2 End-inspiratory flow method	TR 3-2
3.1.3 Airway pressure method	TR 3-2
3.2 Backup limits	TR 3-3
3.2.1 Time limit	TR 3-4
3.2.2 High circuit pressure limit	TR 3-4
3.2.3 High ventilator pressure limit	TR 3-4
4 Mandatory breath delivery	TR 4-1
4.1 Comparison of pressure- and volume-based mandatory breaths	TR 4-1
4.2 Compliance compensation for volume-based mandatory breaths	TR 4-3
4.3 BTPS compensation for volume-based mandatory breaths	TR 4-5
4.4 Manual inspiration	TR 4-5
5 Spontaneous breath delivery	TR 5-1
6 Assist/control (A/C) mode	TR 6-1
6.1 Breath delivery in A/C	TR 6-1
6.2 Rate change during A/C	TR 6-3

Contents

6.3 Changing to A/C mode.	TR 6-3
7 Synchronous intermittent mandatory ventilation (SIMV)	TR 7-1
7.1 Breath delivery in SIMV	TR 7-2
7.2 Apnea ventilation in SIMV	TR 7-4
7.3 Changing to SIMV mode.	TR 7-5
7.4 Rate change during SIMV	TR 7-7
8 Spontaneous (SPONT) mode	TR 8-1
8.1 Breath delivery in SPONT	TR 8-1
8.2 Changing to SPONT mode	TR 8-1
9 Apnea ventilation	TR 9-1
9.1 Apnea detection	TR 9-1
9.2 Transition to apnea ventilation	TR 9-3
9.3 Key entries during apnea ventilation	TR 9-3
9.4 Resetting apnea ventilation	TR 9-3
9.4.1 Resetting to A/C	TR 9-4
9.4.2 Resetting to SIMV	TR 9-4
9.4.3 Resetting to SPONT	TR 9-4
9.5 Phasing in new apnea intervals	TR 9-5
10 Detecting occlusion and disconnect	TR 10-1
10.1 Occlusion	TR 10-1
10.2 Disconnect	TR 10-3
10.3 Occlusions and disconnect annunciation.	TR 10-5
11 Phasing in setting changes	TR 11-1
12 Ventilator settings	TR 12-1
12.1 Apnea ventilation	TR 12-1
12.2 Circuit type and Ideal Body Weight (IBW)	TR 12-2
12.3 Disconnect sensitivity (D_{SENS})	TR 12-3

12.4 Expiratory sensitivity (E_{SENS}) TR 12-3

12.5 Expiratory time (T_E) TR 12-4

12.6 Flow pattern TR 12-4

12.7 Flow sensitivity (V_{SENS}) TR 12-4

12.8 High spontaneous inspiratory time limit ($\uparrow T_{I_SPONT}$) . . TR 12-5

12.9 Humidification type TR 12-6

12.10 I:E ratio TR 12-7

12.11 Ideal body weight (IBW) TR 12-7

12.12 Inspiratory pressure (P_I) TR 12-7

12.13 Inspiratory time (T_I) TR 12-8

12.14 Mode and mandatory breath type TR 12-8

12.15 $O_2\%$ TR 12-11

12.16 Peak inspiratory flow (\dot{V}_{MAX}) TR 12-12

12.17 PEEP TR 12-12

 12.17.1 PEEP restoration TR 12-13

12.18 Plateau time (T_{PL}) TR 12-13

12.19 Pressure sensitivity (P_{SENS}) TR 12-14

12.20 Pressure support (P_{SUPP}) TR 12-14

12.21 Respiratory rate (f) TR 12-15

12.22 Rise time % TR 12-15

12.23 Safety ventilation TR 12-16

12.24 Spontaneous breath type TR 12-17

12.25 Tidal volume (V_T) TR 12-18

12.26 Vent type TR 12-18

13 Alarms

TR 13-1

13.1 Alarm handling TR 13-1

 13.1.1 Alarm messages TR 13-3

 13.1.2 Alarm summary TR 13-5

13.2 AC POWER LOSS alarm TR 13-23

13.3 APNEA alarm TR 13-23

13.4 CIRCUIT DISCONNECT alarm TR 13-24

13.5 DEVICE ALERT alarm TR 13-24

13.6 High circuit pressure ($\uparrow P_{PEAK}$) alarm TR 13-25

13.7 High delivered $O_2\%$ ($\uparrow O_2\%$) alarm TR 13-26

Contents

13.8	High exhaled minute volume ($\uparrow\dot{V}_{E\text{TOT}}$) alarm	TR 13-26
13.9	High exhaled tidal volume ($\uparrow V_{TE}$) alarm	TR 13-27
13.10	High inspired tidal volume alarm ($\uparrow V_{TI}$, $\uparrow V_{TI\text{MAND}}$, $\uparrow V_{TI\text{SPONT}}$)	TR 13-27
13.11	High respiratory rate ($\uparrow f_{\text{TOT}}$) alarm	TR 13-28
13.12	INSPIRATION TOO LONG alarm	TR 13-28
13.13	Low circuit pressure alarm ($\downarrow P_{\text{PEAK}}$)	TR 13-29
13.14	Low delivered O ₂ % ($\downarrow O_2\%$) alarm	TR 13-29
13.15	Low exhaled mandatory tidal volume ($\downarrow V_{TE\text{MAND}}$) alarm	TR 13-30
13.16	Low exhaled spontaneous tidal volume ($\downarrow V_{TE\text{SPONT}}$) alarm	TR 13-30
13.17	Low exhaled total minute volume ($\downarrow\dot{V}_{E\text{TOT}}$) alarm .	TR 13-31
13.18	PROCEDURE ERROR alarm	TR 13-31

14 Patient data

TR 14-1

14.1	Delivered O ₂ %	TR 14-1
14.2	End expiratory pressure (PEEP)	TR 14-2
14.3	End inspiratory pressure ($P_{I\text{END}}$)	TR 14-2
14.4	Exhaled minute volume ($V_{E\text{TOT}}$)	TR 14-3
14.5	Exhaled tidal volume (V_{TE})	TR 14-4
14.6	I:E ratio (I:E)	TR 14-4
14.7	Intrinsic (auto) PEEP ($PEEP_I$) and total PEEP ($PEEP_{\text{TOT}}$)	TR 14-5
14.8	Mean circuit pressure (P_{MEAN})	TR 14-5
14.9	Peak circuit pressure (P_{PEAK})	TR 14-5
14.10	Plateau pressure (P_{PL})	TR 14-6
14.11	Spontaneous minute volume ($\dot{V}_{E\text{SPONT}}$)	TR 14-6
14.12	Static compliance and resistance (C_{STAT} and R_{STAT}) .	TR 14-7
14.13	Total respiratory rate (f_{TOT})	TR 14-13

15 Safety net

TR 15-1

15.1	Patient problems	TR 15-1
15.2	System faults	TR 15-2
15.3	Ongoing background checks	TR 15-3
15.4	Hardware monitoring circuitry	TR 15-4

15.5 Power on self test (POST)	TR 15-5	
15.6 Short self test (SST)	TR 15-5	
15.7 Extended self test (EST)	TR 15-5	
15.8 Oxygen sensor calibration	TR 15-6	
15.9 Exhalation valve calibration	TR 15-6	
15.10 Ventilator inoperative test	TR 15-6	
15.11 Flow sensor offset calibration	TR 15-7	
15.12 Atmospheric pressure transducer calibration	TR 15-7	
16 Power on self test (POST)		TR 16-1
16.1 Safety	TR 16-1	
16.2 POST characteristics	TR 16-2	
16.3 POST following power interruptions	TR 16-3	
16.4 POST fault handling	TR 16-4	
16.5 POST system interface	TR 16-4	
16.6 POST user interface	TR 16-5	
17 Short self test (SST)		TR 17-1
18 Extended self test (EST)		TR 18-1
18.1 EST results	TR 18-2	
18.2 EST failure handling	TR 18-3	
18.3 EST safety considerations	TR 18-3	
19 RS-232 commands		TR 19-1
19.1 RSET command	TR 19-1	
19.2 SNDA command	TR 19-1	
19.3 SNDF command	TR 19-8	

This page is intentionally blank.

Operator’s Manual

Figure 1-1. Puritan Bennett 840 Ventilator System block diagram . . OP 1-4

Figure 1-2. Puritan Bennett 840 Ventilator System
Graphic User Interface (GUI) OP 1-10

Figure 2-1. How to lift the ventilator components OP 2-2

Figure 2-2. How to connect the ventilator power cord OP 2-7

Figure 2-3. Ventilator power switch, AC indicator, and AC panel . . . OP 2-8

Figure 2-4. Power cord storage on the RTA cart OP 2-10

Figure 2-5. Power cord storage on the newer Puritan Bennett
800 Series Ventilator Compressor Mount Cart and
Puritan Bennett 800 Series Ventilator Pole Cart (shown) . OP 2-11

Figure 2-6. How to connect the air and oxygen supplies OP 2-13

Figure 2-7. How to connect the patient circuit OP 2-17

Figure 2-8. How to install the expiratory filter and collector vial OP 2-19

Figure 2-9. How to use the collector vial with or without the drain bag OP 2-21

Figure 2-10. How to install the flex arm on RTA cart OP 2-22

Figure 2-11. How to install the flex arm on the newer
Puritan Bennett 800 Series Ventilator Compressor
Mount Cart or Puritan Bennett 800 Series Ventilator
Pole Cart OP 2-23

Figure 2-12. How to install the humidifier
(Fisher & Paykel version shown) for ventilators mounted
on RTA carts OP 2-26

Figure 2-13. Location of cart lot number label. OP 2-28

Figure 2-14. How to lock and unlock the RTA cart’s front wheels. OP 2-29

Figure 2-15. How to lock and unlock the Puritan Bennett 800
Series Ventilator Compressor Mount Cart or
Puritan Bennett 800 Series Ventilator Pole Cart
front wheels OP 2-29

Figure 3-1. Test button location OP 3-6

Figure 4-1. Touch screen user interface OP 4-2

Figure 4-2. Ventilator Startup screen OP 4-3

Figure 4-3. Touch screen appearance during normal ventilation
(shown with alarm silence and
100% O₂/CAL in progress) OP 4-10

Figure 4-4. T_I (or T_H) selected as the constant during rate change. . . OP 4-20

Figures

Figure 4-5.	Alarm setup	OP 4-23
Figure 4-6.	New patient setup screen — NIV	OP 4-31
Figure 4-7.	NIV ventilator settings screen	OP 4-33
Figure 4-8.	New patient default alarm settings	OP 4-35
Figure 4-9.	More patient data screen — NIV	OP 4-38
Figure 5-1.	Alarm indicators	OP 5-1
Figure 5-2.	Alarm Silence in Progress indicator (lower screen).	OP 5-3
Figure 5-3.	Alarm log	OP 5-5
Figure 5-4.	Alarm message format	OP 5-8
Figure 6-1.	Pressure-volume loop	OP 6-2
Figure 6-2.	Flow-volume loop.	OP 6-3
Figure 7-1.	How to empty the collector vial and seal the drain bag	OP 7-16
Figure 7-2.	806 compressor with inlet filter.	OP 7-17
Figure 7-3.	Dislodge the O ₂ sensor access cover	OP 7-21
Figure 7-4.	Open O ₂ sensor access port	OP 7-22
Figure 7-5.	Locate O ₂ sensor	OP 7-23
Figure A-1.	Recommended patient circuit configurations	OP A-26
Figure B-1.	Ventilator accessories	OP B-2
Figure B-2.	Ventilator accessories (Puritan Bennett 800 Series Ventilator Compressor Mount Cart shown).	OP B-7
Figure B-3.	Puritan Bennett 840 Ventilator System shown mounted on Puritan Bennet 800 Series Ventilator Pole Cart	OP B-12
Figure C-1.	Pneumatic schematic	OP C-1
Figure E-1.	Remote alarm and RS-232 ports	OP E-1
Figure E-2.	Remote alarm port pinout (view from back of GUI).	OP E-2
Figure E-3.	RS-232 serial port pinout	OP E-3

Technical Reference

Figure 2-1.	Declaring inspiration using pressure sensitivity	TR 2-3
Figure 2-2.	Declaring inspiration using flow sensitivity	TR 2-4
Figure 2-3.	Time-cycled inspiration.	TR 2-6
Figure 3-1.	Initiating exhalation using the end-inspiratory flow method	TR 3-2
Figure 3-2.	Initiating exhalation using the airway pressure method	TR 3-3
Figure 6-1.	A/C mode, no patient effort detected	TR 6-2
Figure 6-2.	A/C mode, patient effort detected	TR 6-2
Figure 6-3.	A/C mode, VIM and PIM breaths	TR 6-2

Figure 7-1.	SIMV breath cycle (mandatory and spontaneous intervals)	TR 7-1
Figure 7-2.	SIMV breath cycle, PIM delivered within mandatory interval	TR 7-2
Figure 7-3.	SIMV breath cycle, PIM <i>not</i> delivered within mandatory interval	TR 7-2
Figure 7-4.	Apnea ventilation in SIMV	TR 7-4
Figure 9-1.	Apnea interval equals breath period	TR 9-2
Figure 9-2.	Apnea interval greater than breath period	TR 9-2
Figure 9-3.	Apnea interval less than breath period	TR 9-2
Figure 12-1.	Puritan Bennett 840 Ventilator System modes and breath types	TR 12-10
Figure 13-1.	Alarm message format (upper GUI screen)	TR 13-3

This page is intentionally blank.

Operators' Manual

Table 1-1.	Puritan Bennett 840 Ventilator System GUI controls and indicators	OP 1-11
Table 1-2.	BDU indicators	OP 1-16
Table 1-3.	Puritan Bennett 840 Ventilator System symbols and abbreviations	OP 1-17
Table 2-1.	Patient circuit and IBW values	OP 2-16
Table 3-1.	SST test sequence	OP 3-9
Table 3-2.	Individual SST test results	OP 3-15
Table 3-3.	Overall SST outcomes	OP 3-16
Table 4-1.	Ideal Body Weight (IBW) based on patient height	OP 4-12
Table 4-2.	Soft bound ranges for Ideal Body Weight (IBW) and tube Internal Diameter (ID)	OP 4-14
Table 4-3.	Patient circuit and IBW values	OP 4-15
Table 4-4.	Monitored ventilator control parameters	OP 4-17
Table 4-4.	Automatic settings changes — INVASIVE to NIV on same patient	OP 4-36
Table 4-5.	Automatic settings changes — NIV to INVASIVE on same patient	OP 4-37
Table 5-1.	Alarm messages	OP 5-9
Table 7-1.	Procedures to clean, disinfect, and sterilize parts.	OP 7-3
Table 7-2.	Disinfection and sterilization procedures.	OP 7-7
Table 7-3.	Operator preventive maintenance procedures and frequency	OP 7-10
Table 7-4.	Service preventive maintenance procedures and intervals.	OP 7-26
Table A-1.	Physical characteristics	OP A-3
Table A-2.	Environmental requirements.	OP A-6
Table A-3.	Pneumatic specifications.	OP A-6
Table A-4.	Electrical specifications	OP A-8
Table A-5.	Compliance and approvals	OP A-12
Table A-6.	Electromagnetic Emissions	OP A-14
Table A-7.	Electromagnetic Immunity	OP A-15
Table A-8.	Electromagnetic Immunity – conducted and radiated RF	OP A-17

Tables

Table A-9.	Recommended separation distances between portable and mobile RF communications equipment and the Puritan Bennett 840 Ventilator System	OP A-19
Table A-10.	Compliant cables	OP A-20
Table A-11.	Technical Specifications	OP A-21
Table A-12.	Patient circuit configurations	OP A-27
Table A-13.	Ventilator settings	OP A-29
Table A-14.	Alarm settings	OP A-47
Table A-15.	Patient data	OP A-53
Table A-16.	Other Screens — displayed data.	OP A-59
Table B-1.	Ventilator parts and accessories	OP B-3
Table B-2.	Ventilator parts and accessories	OP B-8
Table B-3.	Ventilator Pole cart and accessories	OP B-13

Technical Reference

Table 4-1.	Comparison of pressure- and volume-based mandatory breaths	TR 4-2
Table 4-2.	Compliance volume factors	TR 4-5
Table 5-1.	Spontaneous breath delivery characteristics	TR 5-1
Table 12-1.	Puritan Bennett 840 ventilator modes and breath types.	TR 12-9
Table 13-1.	Alarm urgency levels	TR 13-2
Table 13-2.	Alarm summary	TR 13-5
Table 13-3.	Applicability of high inspired tidal volume alarm symbols.	TR 13-27
Table 14-1.	Inspiratory pause maneuver displays	TR 14-9
Table 19-1.	MISCA response.	TR 19-3
Table 19-2.	MISCF response	TR 19-9

Introduction

The intended use of the Puritan Bennett™ 840 Ventilator System is for acute and subacute care of infant, pediatric, and adult patients. Software options, available from Puritan Bennett, provide additional ventilation functions.

The Puritan Bennett 840 Ventilator System facilitates work of breathing management, offers selectable modes of breath delivery, and assists the practitioner in the selection of the most appropriate ventilator control parameters for the patient. The user interface is intuitive and easy to operate for those with prior knowledge of ventilator operation.

The user interface includes *DualView*™ touch screens that display monitored patient data for easy assessment of the patient's condition. The touch screens also display the current ventilator control parameters.

The *SandBox*™ area on the touch screen allows the practitioner to preview the selected ventilator control parameters prior to active ventilation of the patient.

The *SmartAlert*™ system intercepts alarms, or events, provides specific information about the cause, and prompts the user with actions to resolve the reported condition(s).

The breath delivery unit (BDU) comprises the pneumatics and the patient circuit.

The ventilator uses two independent Central Processing Units (CPUs):

- Breath delivery unit (BDU) CPU
- Graphic user interface (GUI) CPU

The BDU CPU uses the ventilator control parameters, selected by the practitioner, to deliver breaths to the patient. The BDU CPU also runs continuous and extensive operational background checks to ensure proper operation of the ventilator.

The GUI CPU monitors the ventilator and the ventilator/patient interaction. The GUI CPU also monitors the operation of the BDU CPU and prevents simultaneous failure of control and monitor functions when a single fault is reported.

The Puritan Bennett 840 Ventilator System supplies mandatory or spontaneous breaths with a preset level of positive end expiratory pressure (PEEP), trigger sensitivity, and oxygen concentration. A mandatory breath can either be pressure- or volume-controlled, but it is always pressure-controlled in the optional *BiLevel* mode. A spontaneous breath allows patient inspiratory flows of up to 200 L/min, with or without pressure support.

The optional 806 Compressor unit provides compressed air to the BDU, and can be used in place of wall or bottled air. The compressor unit is powered through and communicates with the BDU.

The 802 Backup Power Source (BPS) or 803 Extended Backup Power Source provides DC power to the BDU and GUI in the event AC power is lost. A new, fully charged BPS runs the ventilator (without a compressor or a humidifier) for at least 60 minutes (30 minutes on ventilators built prior to July 2007), which allows transport of the patient and the ventilator within the healthcare facility. The 803 BPS (available after October 2009) can power the ventilator for at least four hours under the same conditions. The same conditions apply, respectively, to the one-hour or four-hour BPS assembly in the Puritan Bennett 800 Series Ventilator Compressor Mount Cart and the one-hour or four-hour batteries in the Puritan Bennett 800 Series Ventilator Pole Cart.

This manual tells you how to operate and perform simple maintenance for the Puritan Bennett 840 Ventilator System. Become familiar with this manual and accompanying labels before attempting to operate or maintain the ventilator.

To ensure optimum performance of the Puritan Bennett 840 Ventilator System, Puritan Bennett strongly recommends certified biomedical engineering technicians, or other personnel with equivalent experience and training in the service of this type of equipment perform periodic maintenance on the ventilator. For more information, contact Puritan Bennett Technical Services in

the U.S. at 1.800.255.6774. Outside of the U.S., contact your local Puritan Bennett representative.

1.1 Technical description

1.1.1 General background

The practitioner uses the GUI touch screens, the off-screen keys, and GUI knob to select the ventilator control parameters and input data (see Figure 1-1). The GUI CPU processes this information and stores it in ventilator memory. The BDU CPU uses this stored information to control and monitor the flow of gas to and from the patient. The two CPUs communicate to transfer and verify any new ventilator control parameters or alarm limits. Each CPU then performs continuous background verification of operational and data integrity.

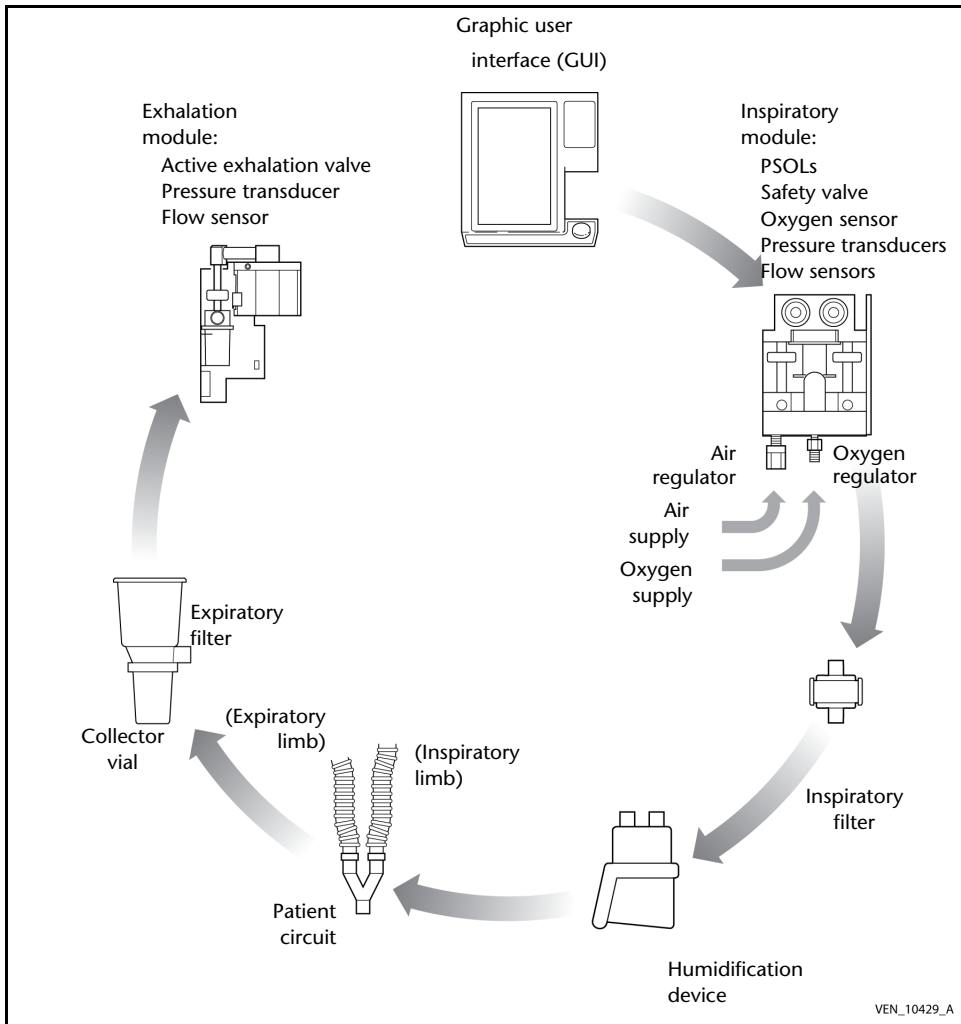

Figure 1-1. Puritan Bennett 840 Ventilator System block diagram

1.1.2 Pressure and flow triggering

The ventilator uses flow or pressure triggering to recognize patient effort. When *pressure triggering* is in effect, the ventilator monitors pressure in the patient circuit. As the patient draws gas from the circuit and airway pressure drops by at least the value selected for pressure sensitivity, the ventilator delivers a breath.

When *flow triggering (Flow-by[®])* is in effect, the ventilator monitors the difference between the inspiratory and expiratory flow sensor measurements. As the patient inhales, the ventilator measures less exhaled flow while the delivered flow remains constant. The result is an increase in the difference between the inspiratory and expiratory flows. When the difference is at least the operator-selected value for flow sensitivity, the ventilator delivers a breath.

If the patient is not inhaling, any difference between the delivered and exhaled flow is due to sensor inaccuracy or leaks in the patient system. To compensate for leaks in the patient system which can cause autotriggering, the operator can increase the flow sensitivity setting.

As a backup method of triggering inspiration, a pressure sensitivity of 2 cmH₂O is also in effect. This setting is the most sensitive setting still large enough to avoid autotriggering, yet will trigger with acceptable patient effort.

1.1.3 Breathing gas mixture

Air and oxygen from cylinders, wall supplies, or compressor (air only) enter the ventilator through hoses and fittings (the fittings are available in several versions). Once inside the ventilator, air and oxygen are regulated to pressures appropriate for the ventilator, then mixed according to the selected O₂%.

The ventilator delivers the mixed air and oxygen through the *inspiratory module* and out to the patient. The oxygen concentration of the delivered gas is monitored here, using a galvanic oxygen sensor. The galvanic sensor generates a voltage proportional to the oxygen concentration. The ventilator reports an alarm if the O₂ sensor is enabled and monitored oxygen concentration is more than seven percent above or below the O₂% setting, or below 18% after the concentration stabilizes.

The inspiratory manifold also includes a safety valve to relieve patient pressure if necessary (for example, if the patient circuit is kinked or occluded). The inspiratory module also corrects for gas temperature and humidity, based on the practitioner-set humidification type.

1.1.4 Inspiratory pneumatics

Ventilator inspiratory pneumatics consist of two parallel circuits: one for oxygen and one for air. The primary elements of the inspiratory pneumatics are two proportional solenoid valves (PSOLs), which control the flow of gas delivered to the patient. Air and oxygen flow sensors, along with pressure signals from the patient circuit, provide feedback that the BDU CPU uses to control the PSOLs.

As a result, the ventilator supplies mixed breathing gas to the patient, based on the practitioner-set ventilator control parameters. The mixed air and oxygen passes through the patient circuit external to the ventilator. The system delivers the breathing gas mixture to the patient at the patient wye, located in the external patient circuit.

1.1.5 Patient circuit

The *patient circuit* comprises the components external to the ventilator that route gas between the ventilator and the patient. These components include:

- an *inspiratory filter* that protects against contamination between the patient and ventilator
- a humidification device (optional) in line with the patient circuit
- the inspiratory and expiratory limbs of the patient circuit that conduct the breathing gas to and from the patient
- a *collector vial* that protects the expiratory pneumatics from bulk moisture in the exhaled gas
- an *expiratory filter* that limits the escape of microorganisms and particulates in the patient's exhaled gas into the room air or inside the ventilator exhalation pneumatics

The ventilator actively controls the exhalation valve that the software accurately positions throughout the patient's inspiration and exhalation. The exhalation valve allows the ventilator to deliver aggressive breaths while pressure overshoots are minimized, PEEP is controlled, and excess patient pressures are relieved. The exhalation system monitors the exhaled gas leaving the patient circuit for spirometry.

NOTE:

The Puritan Bennett 840 Ventilator System does not have the capability to reduce pressure below the PEEP pressure during the expiratory phase.

Throughout the respiratory cycle, pressure transducers monitor inspiratory, expiratory, and atmospheric pressures. The temperature of the exhaled gas is heated to a temperature above its dew point to prevent condensation in the exhalation compartment. Refer to Appendix C for a detailed diagram of the ventilator's pneumatic system and patient circuit.

1.1.6 AC mains and backup power system

The ventilator derives its power to operate from the AC mains (wall) power or the backup power system (BPS). The design of the BDU integral power supply protects against excessive voltages, temperatures, or current draws. A power cord retainer prevents accidental disconnection of the BDU from the AC mains. A power switch cover on the front face of the BDU protects against spills and accidental AC power-off.

The ventilator connects to the 802 or 803 BPS, which supplies DC power to the ventilator if AC power is lost. A fully charged 802 BPS operating under nominal ambient conditions, can power the ventilator for at least 60 minutes (30 minutes on ventilators built prior to July 2007). The 803 extended BPS can power the ventilator for at least 4 hours under the same conditions. Neither BPS powers the compressor unit or the humidifier, if present. The 803 BPS must be used on Puritan Bennett 840 ventilators with software version AB or higher (part number 4-0 070212-85) or equivalent. The operation and alarms of the 803 BPS are identical

to the 802 BPS. The GUI indicates when the ventilator is operating on the BPS, rather than AC mains.

When AC power is connected, it recharges the BPS. The BPS continues to recharge from the AC power during normal ventilator operation. If the ventilator is mounted on a Puritan Bennett 800 Series Ventilator Compressor Mount Cart and has a four-hour BPS or the ventilator is mounted on a Puritan Bennett 800 Series Ventilator Pole Cart with a four-hour battery, the software version, battery life, and operating conditions are the same as described for the 803 BPS. The battery life and operating conditions for each cart with a one-hour BPS or one-hour battery are equivalent to the description given for the 802 BPS.

1.1.7 Ventilator emergency states

Emergency states include *ventilator inoperative (Vent Inop)* and *safety valve open (SVO)*. When a *Vent Inop* condition occurs, it always includes the *SVO* state. A *SVO* state can also occur independent of a *Vent Inop* condition.

The following describe the two ventilator emergency states:

- *Safety valve open (SVO)*: The ventilator enters a *SVO* state if both air and oxygen supplies are lost, or an occlusion is detected, or the ventilator enters the *Vent Inop* condition.

The safety valve open (*SVO*) state allows the patient to breathe room air unassisted by the ventilator. The ventilator remains in the *SVO* state until the condition that caused the emergency state is corrected.

When the ventilator enters the *SVO* state, the *SVO* indicator on the front face of the BDU illuminates, and a high-urgency alarm sounds.

In case of a malfunction that prevents software from opening the safety valve, there is also an analog circuit that opens the safety valve if system pressure exceeds 100 to 120 cmH₂O.

- *Ventilator inoperative (Vent Inop)*: The ventilator declares a ventilator inoperative condition if a hardware failure or critical software error occurs that could compromise safe ventilation of the patient.

When a *Vent Inop* condition occurs, the *Vent Inop* indicator on the front face of the BDU illuminates and the ventilator enters the *SVO* state, which in turns sounds a high-urgency alarm.

If a *Vent Inop* condition occurs, immediately remove the ventilator from use until qualified service personnel evaluate and correct the *Vent Inop* condition.

If the ventilator declares a *Vent Inop* state, the power on self test (POST) must first verify power levels to the ventilator are acceptable and the functions of the major electronics systems are satisfactory before normal ventilation can resume.

Qualified service personnel must repair the ventilator to correct the problem and execute EST successfully before normal ventilation is allowed.

1.2 Graphic user interface

This section describes the graphic user interface (GUI), the GUI keys, the GUI indicators, and the symbols you see on the GUI.

The graphic user interface (GUI) of the Puritan Bennett 840 Ventilator System comprises the *DualView* touch screens, the off-screen keys located below the touch screens, and a knob. Use the knob to set a given ventilator control parameter to its desired value. Press the ACCEPT key — the off-screen key above and right of the knob — to enter the selected value or parameter into memory.

Figure 1-2 identifies the components of the GUI, and the location of information on the *DualView* touch screens.

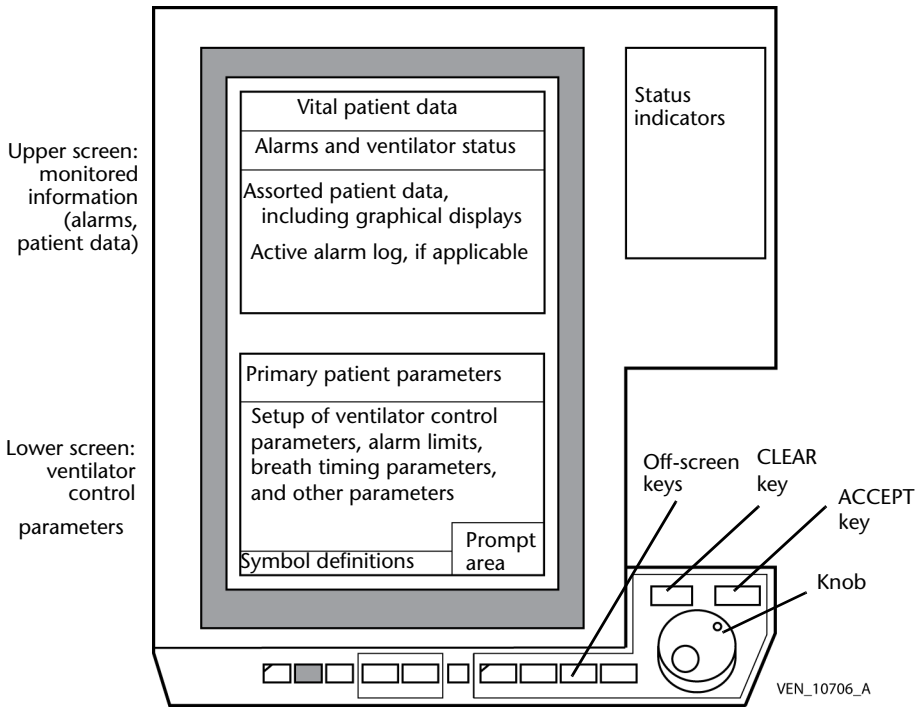

Figure 1-2. Puritan Bennett 840 Ventilator System Graphic User Interface (GUI)

1.3 User interface controls and indicators

Descriptions of the controls and indicators on the graphic user interface are given in Table 1-1 below.

Table 1-1: Puritan Bennett 840 Ventilator System GUI controls and indicators



Control or indicator	Function
 <p data-bbox="296 621 395 639">VEN_10368_A</p>	<p data-bbox="459 461 1113 597">Screen lock key: When the yellow light on the screen lock key is lit, the screen or off-screen controls (including the knob and ACCEPT key) have no effect when touched until you press the screen lock key again. New alarms automatically unlock the screen and controls.</p> <p data-bbox="459 610 1069 662">The screen lock allows you to clean the touch screen and prevents inadvertent changes to settings and displays.</p>
 <p data-bbox="296 846 395 863">VEN_10374_A</p>	<p data-bbox="459 688 1085 766">Alarm volume key: Allows you to adjust the alarm volume when you hold down this key while turning the knob. You cannot turn off the alarm volume.</p>
 <p data-bbox="296 1065 395 1083">VEN_10375_A</p>	<p data-bbox="459 899 1113 1091">Alarm silence key: Turns off the audible alarm for two minutes. The yellow light on the alarm silence key illuminates during the silence period. An ALARM SILENCE IN PROGRESS indicator displays on the lower touch screen, along with a CANCEL button, if there is not a higher-priority alarm display active. To exit out of the alarm silence, touch the CANCEL button.</p> <p data-bbox="459 1104 1113 1214">The system automatically exits the alarm silence when the two-minute interval times out. High-urgency alarms such as Device Alerts, Safety Valve Open, Occlusion, and loss of either gas supply cancel the alarm silence.</p> <p data-bbox="459 1227 1103 1338">Each time you press the alarm silence key, the silence period resets to two minutes. Each time you press the alarm silence key (whether or not there is an active alarm), the keypress is recorded in the alarm log.</p>

Table 1-1: Puritan Bennett 840 Ventilator System GUI controls and indicators (cont)







Control or indicator	Function
 <p>VEN_10376_A</p>	<p>Alarm reset key: Clears active alarms or resets high-urgency alarms and cancels an active alarm silence. Each time you press the reset key, it is recorded in the alarm log, if there is an active alarm. You cannot reset a DEVICE ALERT alarm.</p>
 <p>VEN_10378_A</p>	<p>Information key: Displays basic operating information about the ventilator. Press the key to display a menu of information topics, then touch the button corresponding to the desired topic. Browse topical information using the , , and  buttons located in the information header.</p>
 <p>VEN_10379_A</p>  <p>VEN_10380_A</p>	<p>Oxygen sensor calibration key: Older ventilators use the 100% O₂/CAL 2 min key and newer ventilators use the INCREASE O₂ 2 min key. Delivers 100% oxygen (if available) for two minutes and calibrates the oxygen sensor. The green light on this key illuminates and a message (100% O₂ Cal in Progress) on the lower touch screen indicates 100% O₂ delivery is active. If you press the O₂ key again, the system restarts the two-minute delivery interval. Press CANCEL to stop the calibration. See page TR 15-6 for information on calibrating the oxygen sensor.</p> <p>Use the procedure in Appendix D.2 to test the oxygen sensor calibration.</p>
 <p>VEN_10381_A</p>	<p>Manual inspiration key: In A/C, SIMV, and SPONT modes, delivers one manual breath to the patient in accordance with the current mandatory breath parameters. In BILEVEL mode, transitions from Low PEEP (PEEP_L) to High PEEP (PEEP_H) (or vice versa). To avoid breath stacking, a manual inspiration is not delivered during inspiration or during the restricted phase of exhalation.</p> <p>You can use the MANUAL INSP key to supplement minute volume or to assist measurement of a patient data parameter, such as peak inspiratory pressure, or to run an INSP PAUSE maneuver in SPONT mode.</p>

Table 1-1: Puritan Bennett 840 Ventilator System GUI controls and indicators (cont)

Control or indicator	Function
<div data-bbox="210 318 395 427" style="border: 1px solid black; border-radius: 10px; padding: 10px; text-align: center; width: fit-content; margin: 0 auto;"> <p>EXP PAUSE</p> </div> <p data-bbox="305 479 401 496" style="margin-top: 20px;">VEN_10382_A</p>	<p data-bbox="459 310 1113 448">Expiratory pause key: Causes the ventilator to seal the patient’s breathing circuit when the expiratory phase of a designated breath, mandatory or spontaneous, is followed by a time-cycled mandatory inspiration. An expiratory pause is used to estimate PEEP_{TOT} and PEEP_I (autoPEEP).</p> <p data-bbox="459 459 1113 646">The ventilator performs two types of pause maneuver: <i>automatic</i>, which you initiate by a momentary press of the EXP PAUSE key, and <i>manual</i>, which you control by a continuous press on the key. An <i>automatic</i> pause performs the maneuver until the pressure stabilizes, then takes its measurements. The pause lasts at least 0.5 second and does not exceed 3.0 seconds.</p> <p data-bbox="459 657 1113 821">During a <i>manual</i> pause, the ventilator takes its measurements as soon as the pressure stabilizes or the pause ends. The ventilator continues the maneuver until you release the EXP PAUSE key. The pause cannot exceed 20 seconds. Section 4.9 on page OP 4-25 describes, in detail, how to use the EXP PAUSE key.</p>

Table 1-1: Puritan Bennett 840 Ventilator System GUI controls and indicators (cont)

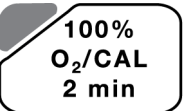
Control or indicator	Function
<div data-bbox="133 315 321 423" style="border: 1px solid black; border-radius: 15px; padding: 10px; text-align: center;"> <p>INSP PAUSE</p> </div> <p data-bbox="231 477 330 493">VEN_10383_A</p>	<p>Inspiratory pause key: Causes the ventilator to seal the patient’s breathing circuit at the conclusion of the gas delivery phase of a designated, volume- or pressure-based mandatory inspiration. This inspiratory pause maneuver provides a means to measure the patient’s static lung-thoracic compliance (C_{STAT}), static resistance (R_{STAT}), and plateau pressure (P_{PL}). The inspiratory pause maneuver maintains the inflated state of the lungs.</p> <p>The ventilator performs two types of pause maneuver: <i>automatic</i>, which is initiated by the momentary press of the INSP PAUSE key, and <i>manual</i>, which you control by a continuous press on the key.</p> <p>An <i>automatic</i> pause performs the maneuver until the pressure stabilizes, then the system takes its measurements. The pause event lasts at least 0.5 second but no longer than 2.0 seconds.</p> <p>In a <i>manual</i> pause, the maneuver continues until you release the INSP PAUSE key, but cannot exceed 7 seconds. The ventilator computes C_{STAT} and R_{STAT} at the end of the plateau and displays the values at the end of the maneuver. P_{PL} is computed and updated continuously during the plateau, and its value is frozen at the end of the plateau. Section 4.10 on page OP 4-26 describes, in detail, how to use the INSP PAUSE key.</p>
 <p data-bbox="284 1190 321 1198">VEN_10384_A</p>	<p>Knob: Adjusts the value of a setting. A highlighted button on a touch screen means the knob is linked to that setting. Where applicable, a clockwise turn of the knob increases the highlighted value, and a counterclockwise turn of the knob decreases the highlighted value.</p>
<div data-bbox="133 1243 327 1365" style="border: 1px solid black; border-radius: 15px; padding: 10px; text-align: center;"> <p>CLEAR</p> </div> <p data-bbox="231 1406 330 1422">VEN_10384_A</p>	<p>Clear: Cancels a proposed ventilator parameter value change.</p>

Table 1-1: Puritan Bennett 840 Ventilator System GUI controls and indicators (cont)

Control or indicator	Function
 <p>VEN_10385_A</p>	<p>Accept: Applies and saves new ventilator parameter value(s).</p>
 <p>VEN_10396_A</p>	<p>Red high-urgency alarm indicator (!!!): This alarm indicator blinks rapidly if active; it is steadily lit if autoreset.</p> <p>Yellow medium-urgency alarm indicator (!!): This alarm indicator blinks slowly if active; it turns off if autoreset.</p> <p>Yellow low-urgency alarm indicator (!): This indicator is steadily lit if active; it turns off if autoreset.</p> <p>Green normal ventilator operation indicator: When ventilation is active and no alarm states exist, this indicator is steadily lit. This indicator is off if the ventilator is not in a ventilation mode, for example, during service mode or short self test (SST).</p>
<p>VENT INOP</p>	<p>Red ventilator inoperative (VENT INOP) indicator: The ventilator cannot support ventilation and requires service. The ventilator enters the safe state (safety ventilation) and discontinues detection of new patient data or alarm conditions. Qualified service personnel must repair the ventilator to correct the problem and execute EST successfully before normal ventilation is allowed. This indicator is accompanied by an audio signal and cannot be reset.</p>
<p>SAFETY VALVE OPEN</p>	<p>Red safety valve open (SVO) indicator: The ventilator has entered its safe state and opened its safety valve to allow the patient to breathe unassisted from room air.</p>
<p>BATTERY READY</p>	<p>Green BPS ready indicator: The ventilator senses the BPS is installed, operational, and has at least two (2) minutes of estimated run time.</p>

Table 1-1: Puritan Bennett 840 Ventilator System GUI controls and indicators (cont)

Control or indicator	Function
BATTERY ON	Battery on power indicator: When the yellow bar to the right of a lit BPS ready indicator is lit, the ventilator is operating on BPS, and AC power is insufficient to support ventilator operation. During BPS operation, power to the compressor unit and the humidifier outlet is off.
COMPRESSOR READY	Green compressor ready indicator: The compressor cable and air supply hose are connected to the ventilator. The compressor is up to operating pressure but not supplying gas to the ventilator. The compressor motor turns on intermittently to keep the compressor chamber pressurized.
COMPRESSOR ON	Green compressor operating indicator: When lit, compressor is supplying air to the ventilator. This indicator does not light unless the compressor is actually supplying air to the ventilator.

The indicators on the breath delivery unit are shown in Table 1-2.

Table 1-2: BDU indicators

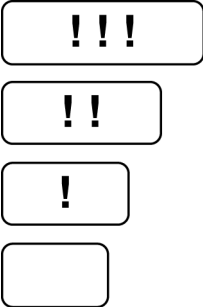
VENT INOP	Red ventilator inoperative (VENT INOP) indicator: The ventilator cannot support ventilation and requires service. The ventilator enters the safe state (safety ventilation) and discontinues detection of new patient data or alarm conditions. Qualified service personnel must repair the ventilator to correct the problem and execute EST successfully before normal ventilation is allowed. This indicator is accompanied by an audio signal and cannot be reset.
SAFETY VALVE OPEN	Red safety valve open (SVO) indicator: The ventilator has entered its safe state and opened its safety valve to allow the patient to breathe unassisted from room air.
DISPLAY (GUI) INOP	Red loss of GUI indicator: The ventilator has detected a malfunction that prevents the GUI from reliably displaying or receiving information.

1.3.1 Onscreen symbols and abbreviations

Touch an onscreen symbol to display its definition in the lower left corner of the lower screen. Table 1-3 summarizes the symbols and abbreviations the ventilator uses. For example, if you touch:

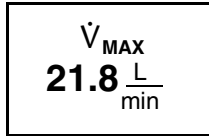

The symbol definition area shows this message:

$$\dot{V}_{MAX} = \text{Peak flow}$$

Table 1-3: Puritan Bennett 840 Ventilator System symbols and abbreviations





Symbol or abbreviation	Definition
 (blinking)	Additional alarms related to the monitored information are active. The symbol blinks when there is not enough screen area to display all active alarms.
	The upper alarm limit
	The lower alarm limit
	Press to access the alarm log
	Alarm log contains events not yet viewed

Table 1-3: Puritan Bennett 840 Ventilator System symbols and abbreviations (cont)







Symbol or abbreviation	Definition
	Rise time percent
	Flow pattern
	The value you selected for a ventilator control parameter exceeds its <i>recommended</i> limit (soft bound) and requires acknowledgement to continue or The value selected exceeds its <i>allowable</i> minimum or maximum limit (hard bound)
	Press to view more patient data
	Press to view patient data graphics
	Press to view additional screens
	X-axis (time or pressure) adjust of patient data graphics
	Y-axis (pressure, volume, or flow) adjust of patient data graphics
	Baseline pressure (PEEP) adjust

Table 1-3: Puritan Bennett 840 Ventilator System symbols and abbreviations (cont)

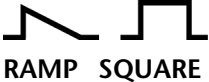
Symbol or abbreviation	Definition
A/C	Assist control ventilation mode
AV	Apnea ventilation
C_{STAT}	Static compliance
E_{SENS}	Spontaneous expiratory sensitivity percentage
EST	Extended Self Test
f	Respiratory rate (ventilator control parameter)
f_{TOT}	Total respiratory rate (monitored)
$\uparrow f_{TOT}$	High respiratory rate alarm
GUI	Graphic user interface
HME	Heat-Moisture Exchanger
I:E	Inspiratory to expiratory ratio
O_2	Monitored oxygen percentage (patient data)
O_2	Oxygen percentage (ventilator control parameter)
$\uparrow O_2\%$	High delivered $O_2\%$ alarm
$\downarrow O_2\%$	Low delivered $O_2\%$ alarm
PC	Pressure control (mandatory breath type)
P_{MEAN}	Mean circuit pressure
$\uparrow P_{PEAK}$	High circuit pressure alarm
$\overline{\uparrow} P_{PEAK}$	High circuit pressure alarm limit
$\downarrow P_{PEAK}$	Low circuit pressure alarm
$\underline{\downarrow} P_{PEAK}$	Low circuit pressure alarm limit

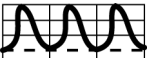
Table 1-3: Puritan Bennett 840 Ventilator System symbols and abbreviations (cont)

Symbol or abbreviation	Definition
P_{PEAK}	Peak circuit pressure (patient data)
PEEP	positive end-expiratory pressure (ventilator control parameter)
$PEEP_H$	High PEEP (ventilator control parameter, BILEVEL mode only)
$PEEP_I$	Intrinsic PEEP (patient data)
$PEEP_L$	Low PEEP (ventilator control parameter, BILEVEL mode only)
$PEEP_{TOT}$	Total PEEP (patient data)
PEEP	End expiratory pressure (patient data)
P_I	Inspiratory pressure (ventilator control parameter)
$P_{I\ END}$	End inspiratory pressure (patient data)
P_{PL}	Plateau pressure (patient data)
POST	Power on self test
PS	Pressure Support (spontaneous breath type)
P_{SENS}	Pressure sensitivity
P_{SUPP}	Pressure support (ventilator control parameter)
P-TRIG	Pressure triggering
$\uparrow P_{VENT}$	High internal ventilator pressure alarm
R_{STAT}	Static resistance
SIMV	Synchronous intermittent mandatory ventilation mode
SPONT	Spontaneous ventilation mode
SST	Short self test
T_A	Apnea interval

Table 1-3: Puritan Bennett 840 Ventilator System symbols and abbreviations (cont)

Symbol or abbreviation	Definition
T_E	Expiratory time
T_H	High PEEP time (BILEVEL mode only)
T_I	Inspiratory time
$\uparrow T_{I\ SPONT}$	High spontaneous inspiration time alarm
$\uparrow\uparrow T_{I\ SPONT}$	High spontaneous inspiration time alarm limit
T_L	Low PEEP time (BILEVEL mode only)
T_{PL}	Plateau time
$\dot{V}_E\ SET$	Set minute volume (calculated from ventilator control parameters)
$\dot{V}_E\ SPONT$	Exhaled spontaneous minute volume
$\uparrow\dot{V}_E\ TOT$	High exhaled minute volume alarm
$\downarrow\dot{V}_E\ TOT$	Low exhaled minute volume alarm
VC	Volume control (mandatory breath type)
\dot{V}_{MAX}	Peak flow (ventilator control parameter)
\dot{V}_{SENS}	Flow sensitivity
V_T	Tidal volume (ventilator control parameter)
V_{TE}	Exhaled tidal volume
$\uparrow V_{TE}$	High exhaled tidal volume alarm
$\downarrow V_{TE\ MAND}$	Low exhaled mandatory tidal volume alarm
$\downarrow V_{TE\ SPONT}$	Low exhaled spontaneous tidal volume alarm
V_{TI}	Inspired tidal volume

Table 1-3: Puritan Bennett 840 Ventilator System symbols and abbreviations (cont)



Symbol or abbreviation	Definition
$\uparrow V_{TI}$	High inspired (mandatory or spontaneous) tidal volume alarm*
$V_{TI\ MAND}$	Inspired mandatory tidal volume
$\uparrow V_{TI\ MAND}$	High inspired mandatory tidal volume alarm*
$V_{TI\ SPONT}$	Inspired spontaneous tidal volume
$\uparrow V_{TI\ SPONT}$	High inspired spontaneous tidal volume alarm*
\dot{V} -TRIG	Flow triggering
*Refer to Technical Reference Section 13.10 for information regarding inspired tidal volume alarms.	



1.4 Ventilator system labeling symbols





The following symbols appear on the various components of the Puritan Bennett 840 Ventilator System.

NOTE:

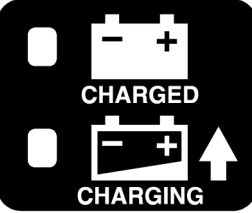
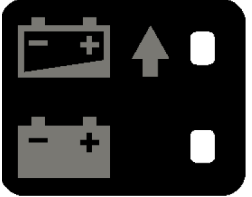

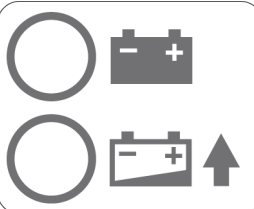
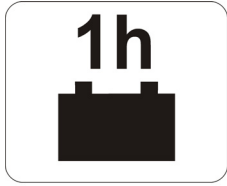
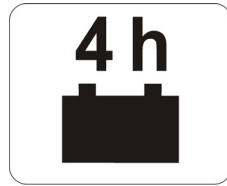

All labels shown are examples, and may not reflect the exact configuration of your ventilator.

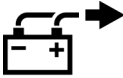

	<p>Power switch positions: ON represents the power on position and  represents the power off position. The power switch, located on the BDU front panel, turns ON/OFF the BDU and the GUI. When the power switch is in the off position, the BPS continues to charge if AC power is present.</p>
	<p>Refer to manual: When this symbol appears on the product, it means refer to documentation for information.</p>

	Type B equipment, per IEC 60601-1
	Potential equalization point (ground): Provides a means of connection between the equipment and the potential equalization busbar of the electrical connection. A common grounding point for the entire ventilator.
IPX1	Indicates the degree of protection provided by enclosure (drip-proof)
	CSA certification mark signifies the product has been evaluated to the applicable ANSI/Underwriters Laboratories Inc. (UL) and CSA standards for use in the US and Canada.
SN	Serial number
 <p style="text-align: right; font-size: small;">VEN_10417_A</p>	802 BPS charging status indicator: When the ventilator is operating on mains power, the top symbol (green LED next to gray battery icon) on the front of the BPS indicates the 802 BPS is charged, and the bottom symbol (yellow LED next to gray battery icon) on the front of the BPS indicates the BPS is charging.
 <p style="text-align: right; font-size: small;">VEN_10076_A</p>	803 BPS charging status indicator: Indicates the charging status of the 803 BPS. A yellow LED next to the partially full battery icon indicates the battery is charging. A green LED next to the full battery icon indicates the battery is charged.

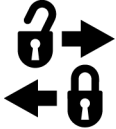
 <p>10038101_E</p>	<p>Charging status indicator on Puritan Bennett 800 Series Ventilator Compressor Mount Cart:Indicates the charging status of the BPS. A yellow LED next to the partially full battery icon indicates the battery is charging. A green LED next to the full battery icon indicates the battery is charged.</p>
 <p>AWV 1004432X02</p>	<p>Battery indicator label: Indicates a one-hour battery is installed in the Puritan Bennett 800 Series Ventilator Compressor Mount Cart.</p>
 <p>AWV 10044351X01</p>	<p>Battery indicator label: Indicates a four-hour battery is installed in the Puritan Bennett 800 Series Ventilator Compressor Mount Cart.</p>
	<p>Charging status indicator on Puritan Bennett 800 Series Ventilator Pole Cart:Indicates the charging status of the battery. A yellow LED next to the partially full battery icon indicates the battery is charging. A green LED next to the full battery icon indicates the battery is charged.</p>
	<p>Battery indicator label: Indicates a one-hour battery is installed in the Puritan Bennett 800 Series Ventilator Pole Cart</p>
	<p>Battery indicator label: Indicates a four-hour battery is installed in the Puritan Bennett 800 Series Ventilator Pole Cart</p>

Data Key	Data key connection Caution <i>Do not remove the data key. The data key enables software options, and stores ventilator operational hours, compressor unit operational hours, and the serial numbers for the BDU and GUI. The ventilator will not operate without its factory-installed data key.</i>
TEST	TEST button: After you touch the Short Self Test (SST) onscreen key (available only during ventilator startup), you must press the TEST button within 5 seconds in order to access SST.
PTS 2000	Puritan Bennett <i>PTS 2000</i> TM Performance Test System connection, for use by qualified service personnel only.
DISPLAY (GUI)	GUI connection
Ventilator circuit breaker	Circuit breaker for ventilator power supply, located in the BDU
Compressor & humidifier circuit breaker	Ventilator circuit breaker for compressor and humidifier
 VEN_10410_A	Alternating current (at AC inlet and AC power indicator)
Compressor outlet: 5.6 A max	Maximum allowed output to auxiliary mains socket (compressor electrical connection)

 <p>VEN_10707_A</p>	<p>BPS electrical connection</p>
 <p>VEN_10708_A</p>	<p>Exhalation filter latch unlock/lock</p>
	<p>Exhalation filter latch open indicator: This red indicator is located on the surface behind the closed latch, and is easily visible when the latch is open.</p>
 <p>VEN_10709_A</p>	<p>GUI mounting latch unlock/lock</p>
 <p>VEN_10710_A</p>	<p>Remote alarm port</p>
<p>IOIOI</p>	<p>RS-232 port</p>
 <p>VEN_10711_A</p>	<p>Susceptible to electrostatic discharge</p>

 <p>VEN_10712_A</p>	<p>Electric shock hazard</p>
 <p>VEN_10713_A</p>	<p>Explosion hazard</p>
 <p>VEN_10714_A</p>	<p>Fire hazard</p>

802 BPS product information label

⚠ WARNING - Do not connect or disconnect while power switch is on or ventilator is connected to AC power.

CAUTION - Use only with Puritan Bennett® 800 Series™ ventilators.

Output (battery) PURITAN BENNETT **802 BPS**
 24 V DC 6.5 Ah

Puritan-Bennett Corporation
 Pleasanton, CA USA

Made in Ireland 4-075427-00 Rev C 0603

VEN_10773_A

803 BPS product information label

Typical Value (at 25°C)

Import 803 BPS (UK)

© Puritan Bennett Corporation
 Pleasanton, CA 94568

WARNING: Do not connect or disconnect while power switch is on or ventilator is connected to AC power.

AVVERTIMENTO: Non collegare né scollegare il ventilatore con l'interruttore acceso e/o l'unità è collegata all'alimentazione a.c.

ADVERTENCIA: No conectes ni desconectes el ventilador eléctrico con el interruptor encendido o conectado a corriente eléctrica (CA).

AVISO: Não ligue nem desligue com o interruptor de alimentação de alimentação ligado ou quando o ventilador estiver ligado a alimentação CA.

BEWAARDE: Het aansluiten/afschakelen van een ventilator moet gebeuren met de stroomvoorziening uitgeschakeld of niet aangesloten op de stroomvoorziening.

OSTREZUWEN: Het verbinden/afbreken van elektrische aansluitingen op een ventilator moet gebeuren met de stroomvoorziening uitgeschakeld of niet aangesloten op de stroomvoorziening.

警告: 電源スイッチがオンになっているか、またはAC電源に接続されている間は、接続または切断を行わないでください。

注意: ヒューマンズネットワーク™ 800シリーズに限り一様に使用してください。

1000001 Revision 4

PURITAN BENNETT
803 BPS 24 V DC 17 Ah

⚠
Caution, consult documents

⚠
Caution, consult documents

CAUTION: Use only with Puritan Bennett™ 800 Series™ ventilators.

PRECAUTION: Utilizar únicamente con los ventiladores Puritan Bennett™ 800 Series™.

VERBOD: Het niet gebruiken van Puritan Bennett™ 800 Series™-ventilatoren.

ATTENZIONE: Utilizzare solo con i ventilatori Puritan Bennett™ 800 Series™.

PRECAUTION: Utilizar únicamente con ventiladores Puritan Bennett™ 800 Series™.

AVISO: Utilizar apenas com ventiladores Puritan Bennett™ 800 Series™.

OSTREZUWEN: Verwenden uitsluitend met ventilatoren Puritan Bennett™ 800 Series™.

BEWAARDE: Het gebruik van een ventilator is beperkt tot de gebruiksaanwijzing van de ventilator.

注意: ヒューマンズネットワーク™ 800シリーズに限り一様に使用してください。

VEN_10716_A

Puritan Bennett 800 Series Ventilator System Operator's Manual

OP 1-27

GUI product information label

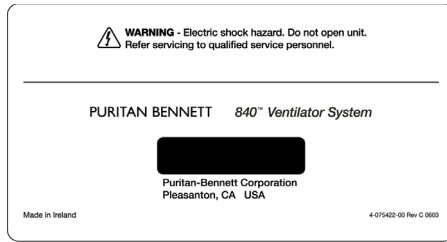

VEN_10774_A

GUI ports label

Remote alarm and RS-232 port (9.4-inch GUI only). Refer to Appendix E for GUI remote alarm and RS-232 port specifications.



VEN_10775_A

Humidifier electrical label

(This label not visible unless cover plate over humidifier electrical connection is removed.)

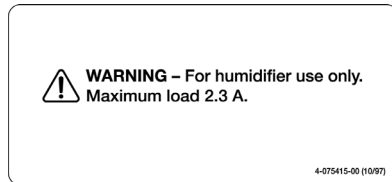

VEN_10776_A

BDU gas inlet label

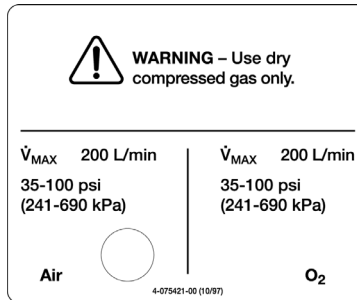

VEN_10777_A

BDU to patient label

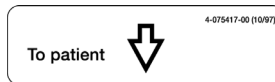

VEN_10778_A

Compressor gas connection label



VEN_10779_A

Compressor information label

 **WARNING** - Do not connect or disconnect while ventilator is operating.

 **WARNING** - Electric shock hazard. Do not open unit. Refer servicing to qualified service personnel.

CAUTION - Use only with Puritan Bennett® 800 Series™ ventilators.

PURITAN BENNETT 806 Compressor

120 V~ 60 Hz



IPX1



U.S. Patents:
5,368,019



Puritan-Bennett Corporation
Pleasanton, CA USA

Made in Ireland

4-076505-00 Rev C 0603

VEN_10780_A

BDU information label

 **WARNING** - This ventilator is not intended to be a comprehensive monitoring device; some types of dangerous conditions will not activate alarms. Patients on life-support equipment should be appropriately monitored by competent medical personnel and suitable monitoring devices.

WARNING - Before use, read Operator's manual thoroughly. Before each use, check equipment for proper operation.

 **WARNING** - Explosion hazard. Do not use near flammable anesthetics.

 **WARNING** - Fire hazard. Keep all sources of ignition away from this device. Combustible materials ignite easily and burn with great intensity in air enriched with oxygen.

 **WARNING** - Electric shock hazard. Do not open unit. Refer servicing to qualified service personnel.

CAUTION - USA federal law restricts this device to sale by or on the order of a physician.

PURITAN BENNETT 840[®] Ventilator System

Ventilator
120 V~ 4.5 A 60 Hz

Ventilator and compressor
120 V~ 10.1 A 60 Hz

U.S. Patents:
4,954,739 5,161,525 5,271,389
5,301,521 5,319,540 5,339,807
5,390,666

Made in Ireland

Puritan-Bennett Corporation
Pleasanton, CA USA

 IPX1

4-075423-00 Rev C 0602

VEN_10781_A

BDU cooling vent label

 **WARNING – Do not block vents.**

4-075414-00 (10/97)

VEN_10782_A

BDU I/O disconnect label

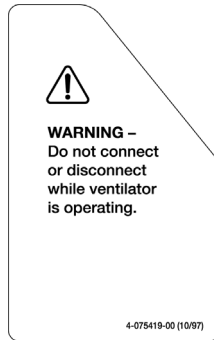

VEN_10783_A

BDU exhaust information label

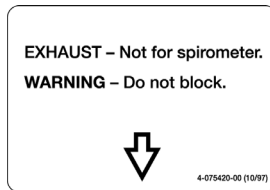

VEN_10784_A

BPS electrical connection label



VEN_10728_A

Compressor lint filter label

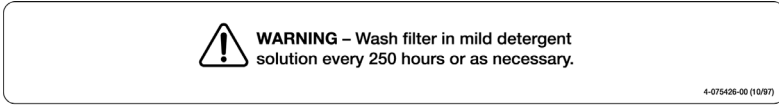

VEN_10785_A

Expiratory limb connector on exhalation filter

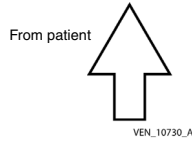

This page is intentionally blank.

How to set up the Puritan Bennett 840 ventilator

Chapter 2 describes how to set up the Puritan Bennett™ 840 Ventilator System:

- How to connect the electrical supply
- How to connect the air and oxygen supplies
- How to connect the patient circuit and accessories

A Puritan Bennett Customer Service Engineer (CSE) must first install the ventilator and run an extended self test (EST), which calibrates the exhalation valve, flow sensors, and atmospheric pressure transducer, before you connect a patient to the ventilator for the first time.

Warning

- **When you lift the ventilator, use assistance and appropriate safety precautions. Figure 2-1 shows the proper technique to lift each ventilator component.**
 - **To avoid interrupted ventilator operation or possible damage to the ventilator, always use the ventilator on a level surface in its proper orientation.**
 - **To avoid the possibility of injury to the patient and ensure proper ventilator operation, do *not* attach any device to the port labeled EXHAUST unless the device is specifically authorized by Puritan Bennett.**
 - **To minimize the increased risk of fire due to an oxygen-enriched environment, do not use the ventilator in a hyperbaric chamber.**
 - **To avoid raising the oxygen concentration of room air, use the ventilator in an adequately ventilated room.**
-

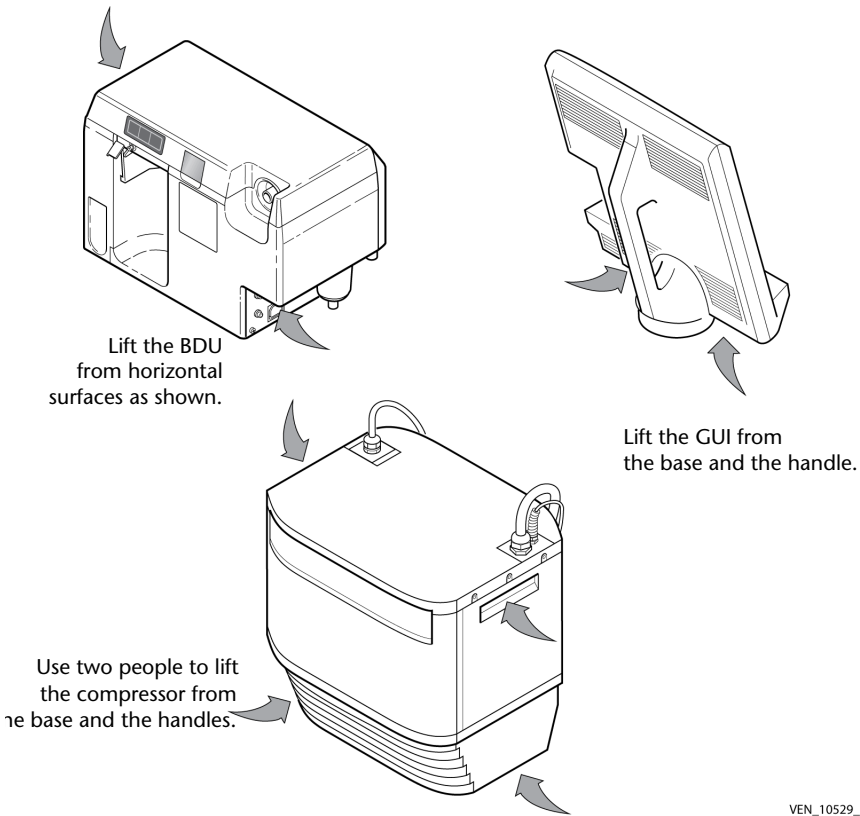

VEN_10529_A

Figure 2-1. How to lift the ventilator components

Caution

- *Do not connect or disconnect the ventilator's graphic user interface (GUI), backup power source (BPS), or compressor while the power switch is on or the ventilator is connected to AC power.*
 - *All components must be securely mounted and connected by qualified service personnel according to the appropriate Puritan Bennett installation instructions.*
 - *Do not obstruct the breath delivery unit (BDU), GUI, or compressor cooling vents or fan vents.*
 - *To avoid possible damage to ventilator components, do not use the horizontal surfaces of the ventilator to place or stack objects.*
-

NOTE:

Before you use the ventilator for the first time, wipe the ventilator exterior clean and sterilize its components according to the instructions in Chapter 7 of this manual. Follow your institution's protocol for cleaning and sterilizing the ventilator and its components.

2.1 How to connect the electrical supply

Warning

- To minimize the risk of electrical shock, always connect the ventilator power cord into a grounded AC power outlet.
 - In the US, always connect the ventilator to an AC receptacle marked "Hospital Only" or "Hospital Grade" to ensure proper grounding of the ventilator.
 - The 802 or 803 BPS must always be installed if you are using an RTA cart. Without the BPS, the ventilator is not protected against low or lost AC power. Do not use the ventilator unless a BPS with at least minimal charge is installed.
 - If you are using a newer Puritan Bennett 800 Series Ventilator Compressor Mount Cart or Puritan Bennett 800 Series Ventilator Pole Cart, you must ensure you connect the battery back-up system harness to the ventilator.
 - Do not disconnect the battery back-up system, GUI, or compressor from the ventilator while in use.
 - When possible, connect the ventilator to an outlet connected to the hospital emergency back-up power system. Refer to Section A.4 for ventilator electrical specifications.
-

Normally the Puritan Bennett 840 Ventilator System is mains-powered. The 802 or 803 BPS or battery backup system in newer Puritan Bennett 800 Series Ventilator Compressor Mount Cart and Puritan Bennett 800 Series Ventilator Pole Cart operates the ventilator when AC power is lost or drops below a minimum level.

A new, fully charged 802 BPS can operate the ventilator (without the compressor or a humidifier) for at least 60 minutes (30 minutes on ventilators built prior to July 2007); allowing the ventilator to be used for transport purposes within the healthcare facility. A new, fully charged 803 BPS (available after October

2009) can operate the ventilator (without the compressor or a humidifier) for at least four hours. The same conditions apply, respectively, to the one-hour or four-hour BPS assembly in the Puritan Bennett 800 Series Ventilator Compressor Mount Cart and the one-hour or four-hour batteries in the Puritan Bennett 800 Series Ventilator Pole Cart.

Warning

The 802 or 803 BPS and the battery backup systems in the Puritan Bennett 800 Series Ventilator Compressor Mount Cart and the Puritan Bennett 800 Series Ventilator Pole Cart are intended for short-term use only, and are not intended as primary alternative power sources. The BPS and battery backup systems are intended to power the BDU and GUI only. In case of AC power loss, power is not available to run either the compressor or the humidifier.

If you turn on the ventilator after it has been unplugged for an extended period, the LOW BATTERY alarm may sound. If this occurs, recharge the 802 or 803 BPS or battery back up system in the Puritan Bennett 800 Series Ventilator Compressor Mount Cart or Puritan Bennett 800 Series Ventilator Pole Cart by leaving it connected to a ventilator connected to AC power for up to eight hours (ventilator does not need to be turned on). Because of the larger battery capacity, the 803 BPS or four-hour BPS or battery in the Puritan Bennett 800 Series Ventilator Compressor Mount Cart or Puritan Bennett 800 Series Ventilator Pole Cart may take up to 20 hours to recharge. If, after turning the ventilator back on, the LOW BATTERY alarm is still active or if the INOPERATIVE BATTERY alarm is active, qualified service personnel must replace the battery. The batteries should be recharged whenever they have been depleted. Leaving them in a discharged state for longer than 24 hours may reduce their capacity. The same conditions apply, respectively, to the one-hour or four-hour BPS assembly in the Puritan Bennett 800 Series Ventilator Compressor Mount Cart and the one-hour or four-hour batteries in the Puritan Bennett 800 Series Ventilator Pole Cart.

Figure 2-2 shows how to connect the power cord to AC power. Built-in power cord retainer tabs protect against accidental disconnection. Ensure the power cord is securely fastened into the

AC receptacle prior to operation. To remove the cord, squeeze the tabs on the top and bottom of the plug and pull outward.

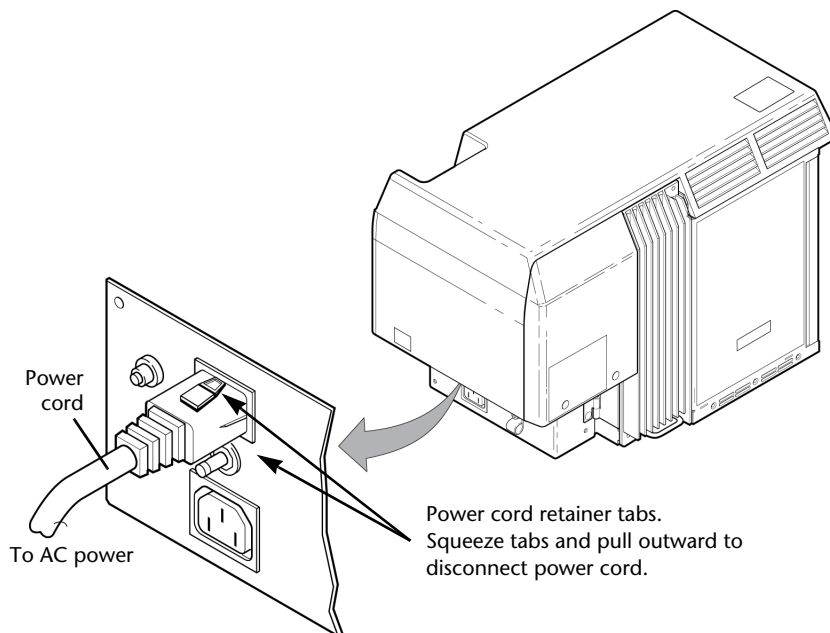

8-10034_A

Figure 2-2. How to connect the ventilator power cord

Figure 2-3 shows the power switch and AC indicator. When illuminated, the AC indicator indicates the ventilator is receiving AC power and the 802 and 803 BPS, and battery backup systems in the Puritan Bennett 800 Series Ventilator Compressor Mount Cart and the Puritan Bennett 800 Series Ventilator Pole Cart will be recharged as needed. The AC indicator is independent of the power switch, and the power switch does not turn off AC power to the ventilator power supply. When both the power switch and AC indicator are on, power is available for the humidifier and compressor.

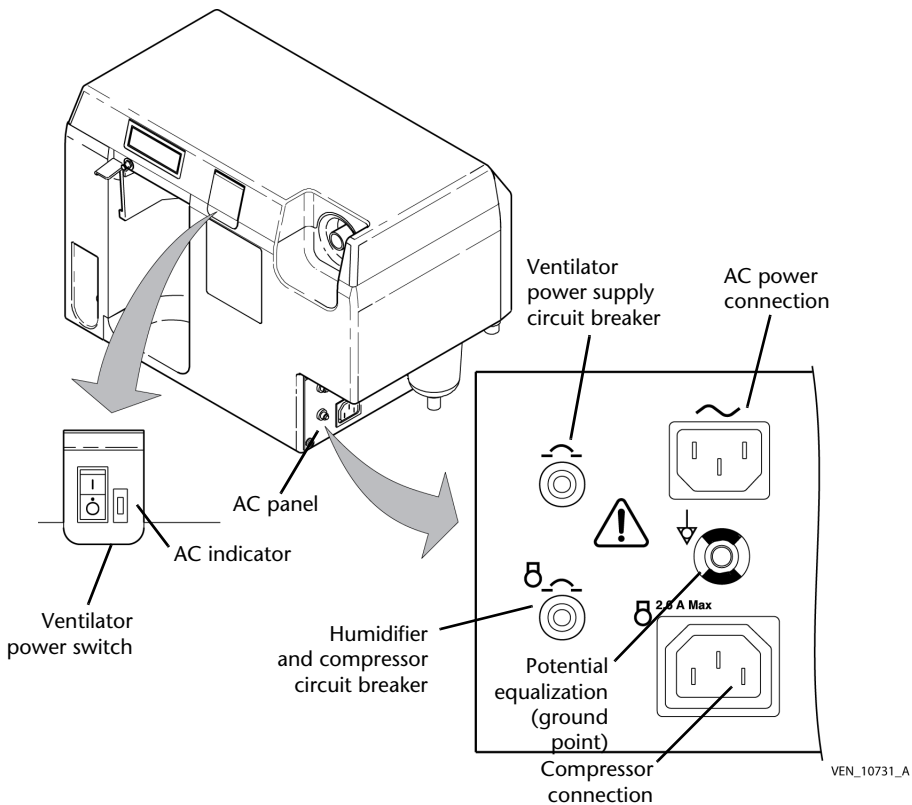
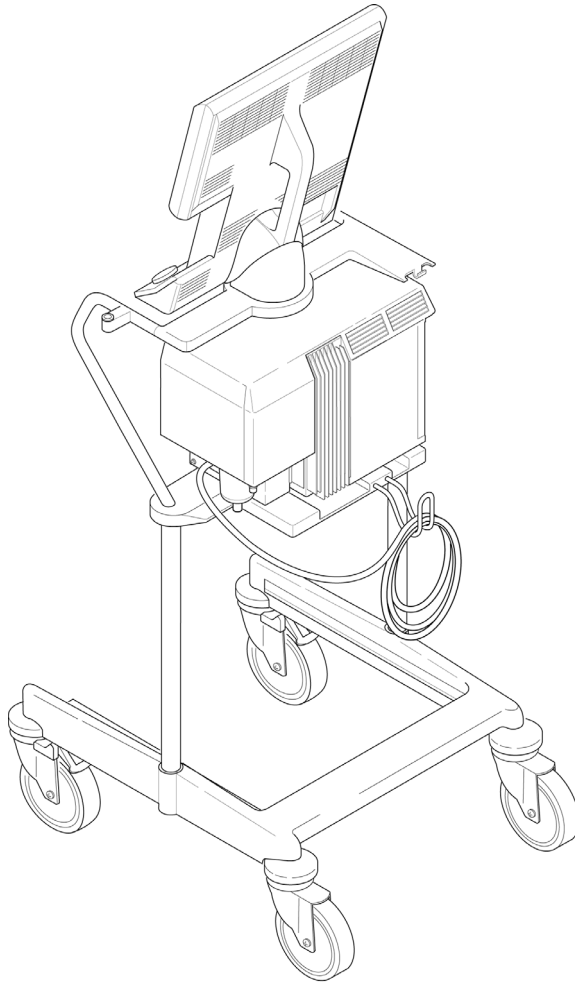

Figure 2-3. Ventilator power switch, AC indicator, and AC panel

If the ventilator power supply circuit breaker (located on the ventilator's AC panel, Figure 2-3) opens but AC power is still present and the ventilator is operating on BPS, power is still available to the humidifier and compressor connectors (although ventilator software disables compressor operation).

When the power cord is not in use, wrap the power cord around the hook on the back of the cart for convenient storage (Figure 2-4 and Figure 2-5). The power cord is stored the same way on the Puritan Bennett 800 Series Ventilator Compressor Mount Cart and the Puritan Bennett 800 Series Ventilator Pole Cart.



VEN_10732_A

Figure 2-4. Power cord storage on the RTA cart

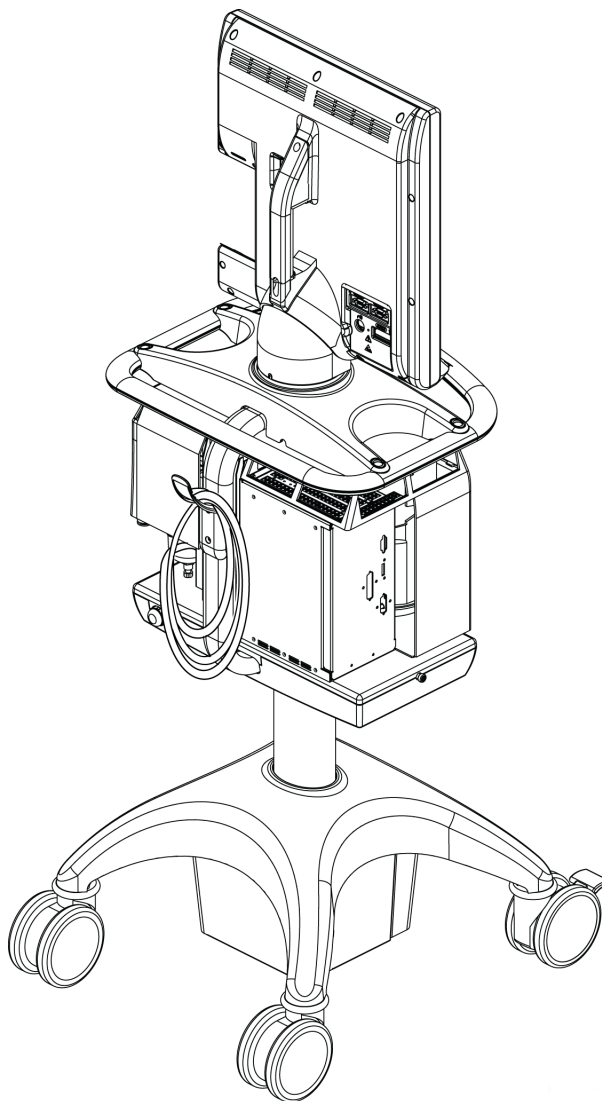

8-10027_A

Figure 2-5. Power cord storage on the newer Puritan Bennett 800 Series Ventilator Compressor Mount Cart and Puritan Bennett 800 Series Ventilator Pole Cart (shown)

2.2 How to connect the air and oxygen supplies

The Puritan Bennett 840 Ventilator System can use air and oxygen from cylinder or wall supplies. Follow these steps to connect the air and oxygen supplies:

- 1 Ensure the supply pressures are 35 to 100 psi (241 to 690 kPa), and the hospital gas piping system complies with ISO 7396:1987, Non-flammable Medical Gas Pipeline Systems, or an equivalent standard. Gas hoses must meet the requirements of EN 739:1998, Low-pressure Hose Assemblies for use with Medical Gases, and NFPA 99:2002, Standard for Healthcare Facilities.
- 2 Connect the supply hoses to the inlet connectors at the rear of the ventilator (see Figure 2-6).

Warning

- **Connect only air to the air inlet, and only oxygen to the oxygen inlet. Do not attempt to switch air and oxygen or connect any other gas.**
 - **Always connect at least two gas sources to the ventilator to ensure a constant gas supply is available to the patient. There are three gas source connections: the compressor, air inlet, and oxygen inlet.**
 - **Do not use anti-static or electrically conductive hoses in the ventilator breathing system.**
 - **Use only gas supply hoses recommended by Puritan Bennett. Other hoses may be restrictive and may cause improper ventilator operation.**
-

Caution

To prevent damage to the ventilator, ensure the connections to the air and oxygen supplies are clean and unlubricated, and there is no water in the air or oxygen supply gas.

If you suspect water in the air supply gas, use an external wall air water trap to prevent water damage to the ventilator or its components.

NOTE:

When you connect a pressurized air or oxygen source, the ventilator air and oxygen regulators have a maximum bleed rate of 3 L/min, even when the ventilator is not in use. Always take this bleed rate into account when calculating air and oxygen usage.

When the air and oxygen hoses are not in use, you can wrap them around the hook on the back of the cart for convenient storage (Figure 2-6).

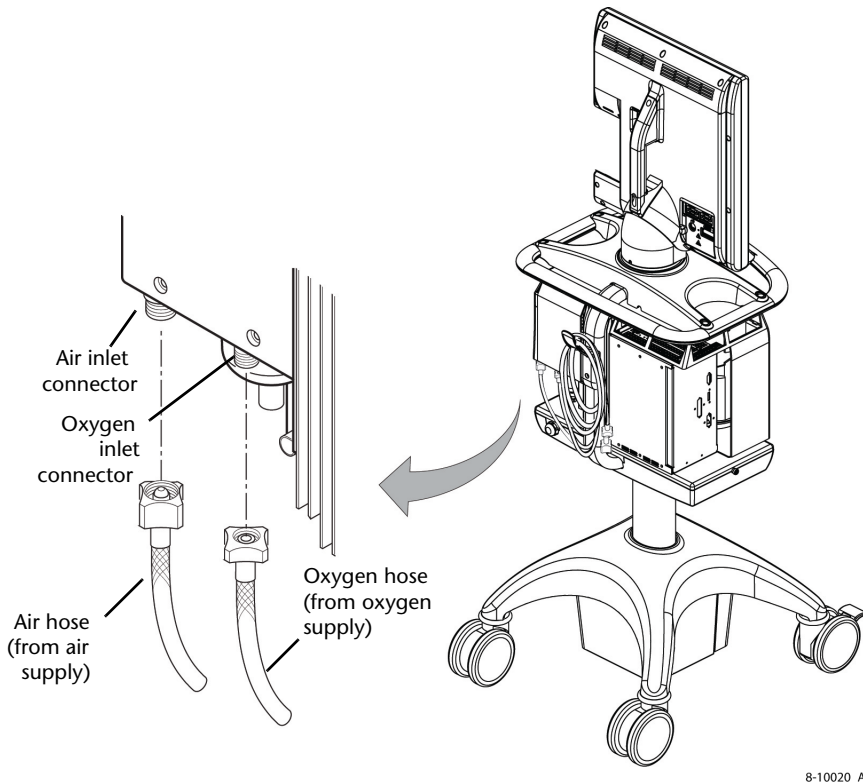

Figure 2-6. How to connect the air and oxygen supplies

2.3 How to connect the patient circuit components

Warning

- To minimize the risk of bacterial contamination or component damage, inspiratory and expiratory filters must always be handled with care and connected to the ventilator during use.
 - To minimize the risk of patient injury, use only patient circuits qualified for use in oxygen-enriched environments with the Puritan Bennett 840 Ventilator System. Do not use anti-static or electrically conductive tubing in the ventilator breathing system. To ensure a leak-tight connection, only use connectors and tubes with ISO-standard cone and socket fittings (or use adapters to connect barbed cuff fittings to ISO-standard fittings).
 - If you use an external, pneumatically-powered nebulizer with the Puritan Bennett 840 Ventilator System, it adds flow to the patient circuit and can adversely affect spirometry, delivered O₂%, delivered tidal volumes, and breath triggering. Additionally, aerosolized particulates in the ventilator circuit can lead to an increase in exhalation filter resistance.
 - Use one of the patient circuits listed in Appendix B to ensure the maximum pressure/flow values specified by IEC 60601-2-12:2001 are not exceeded (see Table A-11 on page OP A-21 for patient circuit testing specifications). Using a circuit with a higher resistance does not prevent ventilation, but can cause a short self test (SST) fault or compromise the patient's ability to breathe through the circuit.
-

NOTE:

- Puritan Bennett recommends you run Short Self Test (SST) every 15 days, between patients, and when you change the patient circuit (particularly when you change the circuit type, for example, from adult to pediatric or neonatal).
 - Puritan Bennett recognizes the protocol for running SST varies widely among health care institutions. Puritan Bennett does not specify or require specific practices that will meet the needs of all institutions, nor is Puritan Bennett responsible for the effectiveness of institutional practices.
-

2.3.1 How to select and connect a patient circuit

Use low-compliance patient circuits to ensure optimum compliance compensation, and use pediatric patient circuits when the patient ideal body weight (IBW) is greater than 7 kg (15 lb) but less than or equal to 24 kg (53 lb). Use the *NeoMode* software option and neonatal patient circuits for patients whose IBW is less than or equal to 7 kg.

For patients whose IBW is less than or equal to 24 kg, the compliance compensation volume limit is four times the set tidal volume, in addition to the set tidal volume. To avoid activating a severe occlusion alarm, only use neonatal patient circuits with the *NeoMode* software option.

Table 2-1 shows IBW values and patient circuit types. The “Allowed but not recommended” ranges require an override.

Warning

Recommended ranges exist to ensure patient safety. Only those with the expertise to judge the appropriate circumstances should override the recommended ranges.

Table 2-1: Patient circuit and IBW values

Recommendation	Ideal body weight (IBW) in kg (lb)
Recommended	Neonatal: 0.3-7.0 kg (0.66-15 lb)* Pediatric: 7.0-24 kg (15-53 lb) Adult: 25-150 kg (55-330 lb) *Assumes NeoMode 2.0 software option is installed
Allowed but not recommended	Neonatal: Not applicable Pediatric: 3.5-6.5 kg (7.7-14.3 lb), and 25-35 kg (55-77 lb) Adult: 7-24 kg (15-53 lb)

Figure 2-7 shows how to connect the patient circuit, including the inspiratory filter, humidifier (if used), inspiratory limb, patient wye, expiratory limb, collector vial, and expiratory filter.

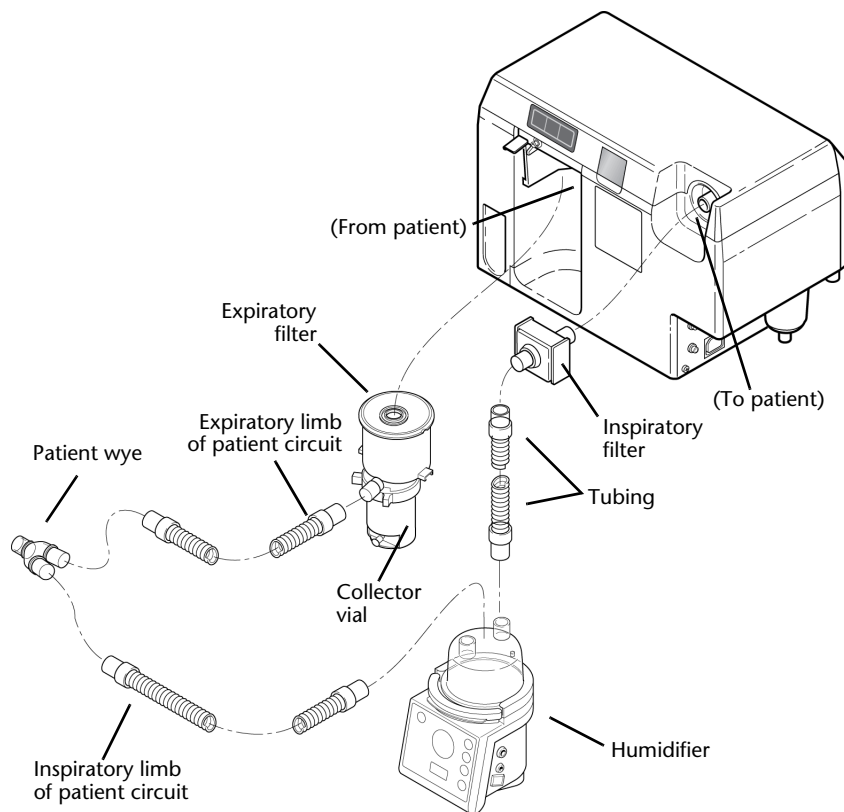

VEN_10733_A

Figure 2-7. How to connect the patient circuit**Warning**

To ensure all patient circuit connections are leak-tight, always perform a circuit leak test by running SST each time you install the expiratory filter on the ventilator.

Warning

Adding accessories to the ventilator can increase system resistance. Ensure any changes to the recommended ventilator circuit configurations do not exceed the specified values for inspiratory and expiratory resistance (Appendix A). If adding accessories to the patient circuit, always run SST to measure circuit compliance before beginning ventilation of the patient.

2.3.2 How to install the expiratory filter and collector vial

Install the expiratory filter and collector vial as follows:

- 1 Place the expiratory filter latch in the up position (see Figure 2-8).
- 2 Slide the expiratory filter into the housing area with the expiratory limb connection facing you.
- 3 Push the expiratory filter latch down; it will position the filter properly.
- 4 Attach the expiratory limb of the patient circuit to the filter's expiratory limb connection.

If you do not use a drain bag, be sure to cap the collector vial drain port on the expiratory filter (Figure 2-9).

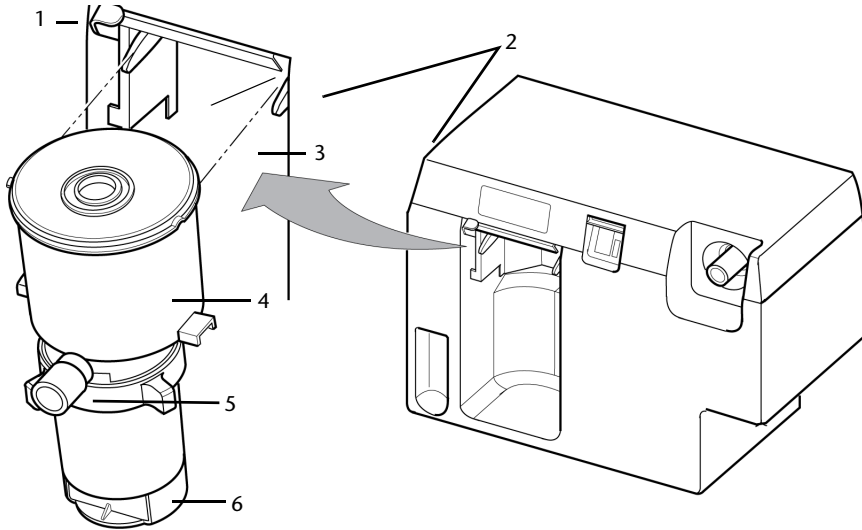

VEN_10734_A

Figure 2-8. How to install the expiratory filter and collector vial

Item	Description
1	Pull latch up to install filter, pull down to hold filter and collector vial in place
2	Slide the filter rim onto these tracks
3	Filter housing area
4	Expiratory filter
5	Expiratory limb connection (from patient)
6	Collector vial

If you use a drain bag:

- 1** Install the expiratory filter. (Refer to the instructions above.)
- 2** Install the clamp on the drain bag tubing, ensuring the clamp is closed.
- 3** Uncap collector vial drain port at the base of the collector vial.

- 4 Connect the collector bag tubing to the vial drain port.
- 5 Connect the other end of tubing to drain bag.
- 6 If the ventilator is mounted on the cart, place the drain bag in the cart drawer (if you have an older style ready-to-assemble cart) or hang the drain bag on the button provided on the side of the newer style Puritan Bennett 800 Series Ventilator Compressor Mount Cart or Puritan Bennett 800 Series Ventilator Pole Cart (Figure 2-9).

Warning

Do not attempt to clean, reprocess, or reuse the drain bag as this poses the risk of infection to medical personnel and the patient.

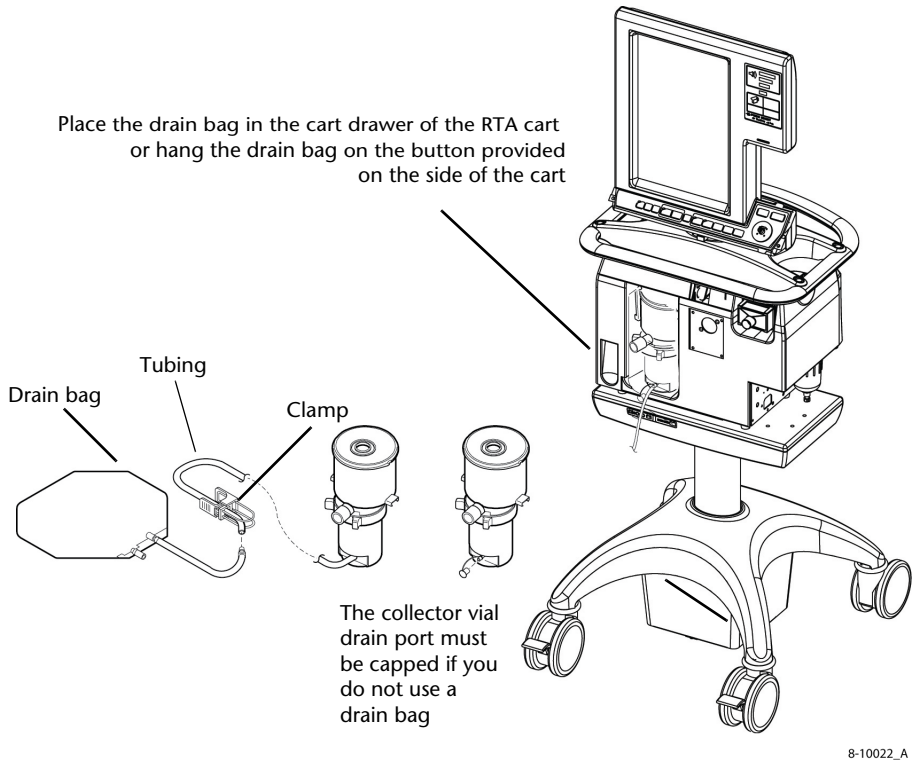

Figure 2-9. How to use the collector vial with or without the drain bag

NOTE:

Check the inspiratory and expiratory limbs of the patient circuit, the collector vial, and the in-line water traps regularly for water buildup. Under certain conditions, they can fill quickly. Empty and clean the collector vial and in-line water traps as necessary.

2.3.3 How to install the flex arm

The flex arm supports the patient circuit between the ventilator and the patient. Figure 2-10 and Figure 2-11 show how to install the flex arm onto one of the two (in ready-to-assemble carts) or

four (in newer Puritan Bennett 800 Series Ventilator Compressor Mount Cart or Puritan Bennett 800 Series Ventilator Pole Cart threaded sockets on the ventilator cart.

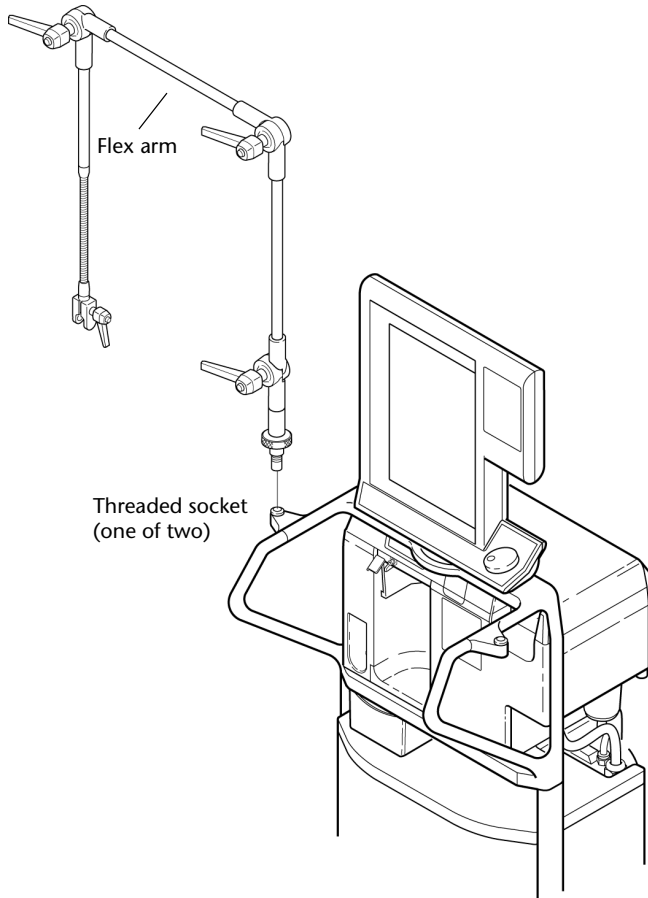

VEN_10735_A

Figure 2-10. How to install the flex arm on RTA cart

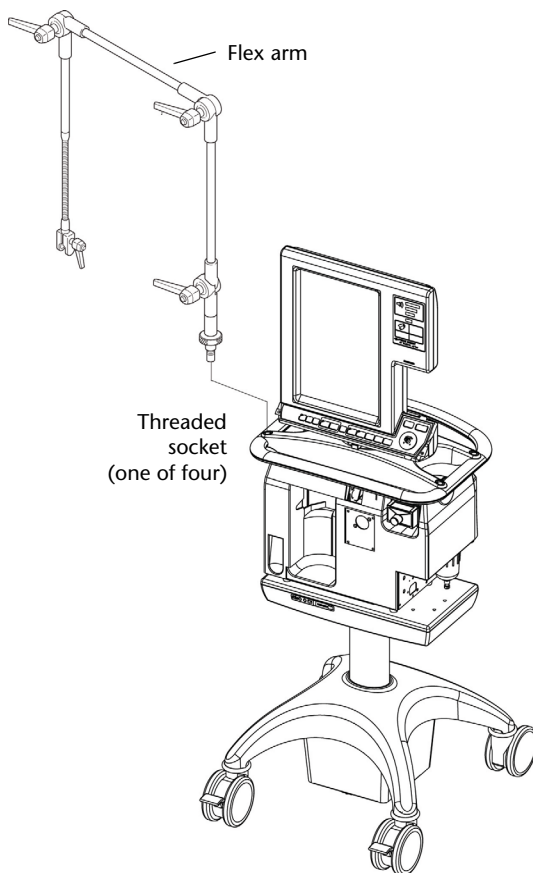

8-10021_A

Figure 2-11. How to install the flex arm on the newer Puritan Bennett 800 Series Ventilator Compressor Mount Cart or Puritan Bennett 800 Series Ventilator Pole Cart

Caution

Use only the cart handles to move the ventilator. Do not pull or push the ventilator with the flex arm.

Flex arm replacement parts can be found in the *Puritan Bennett 800 Series Ventilator Service Manual*.

2.3.4 How to install the humidifier

An electrical outlet for a humidifier is located on the front of the BDU. Figure 2-12 shows how to install a Fisher & Paykel humidifier onto the ventilator for ventilators mounted on RTA carts. Separate humidifier installation instructions are shipped with humidifier mounting kits listed in Table B-2 and Table B-3 of Appendix B for humidifiers mounted on Puritan Bennett 800 Series Ventilator Compressor Mount Carts and Puritan Bennett 800 Series Ventilator Pole Carts, respectively.

Warning

- **When using a Fisher & Paykel humidifier with the Puritan Bennett 840 ventilator, use the appropriate Fisher & Paykel humidifier chambers for adult, pediatric, and neonatal patients.**
 - **Take proper precautions to prevent water/condensate from splashing into the patient circuit during circuit disconnects and high peak flow rate conditions.**
 - **To avoid possible patient injury or damage to the ventilator system, follow your institution's protocol for proper patient circuit condensate management.**
-

Caution

- *Qualified service personnel must first install the humidifier mounting hardware.*
 - *To avoid equipment damage to the ventilator due to liquid ingress:*
 - *Install the plug cover when the humidifier is plugged into the ventilator.*
 - *Install the flat cover plate over the humidifier electrical outlet on the front of the BDU when the humidifier is not plugged into the ventilator.*
-

NOTE:

- To ensure uninterrupted ventilator operation, do not install a humidifier whose maximum current capabilities exceed 2.3 A, with a maximum power consumption of 270 VA.
 - When you install a Fisher & Paykel humidifier, make sure the humidifier has a right-angle electrical plug. A short power cord is preferable.
 - To ensure ventilator occlusion detection operates properly, do *not* use Puritan Bennett Cascade humidifiers with the Puritan Bennett 840 Ventilator System.
 - If you have further questions about humidifiers qualified for use with the Puritan Bennett 840 Ventilator System, contact Technical Services or your local Puritan Bennett representative.
-

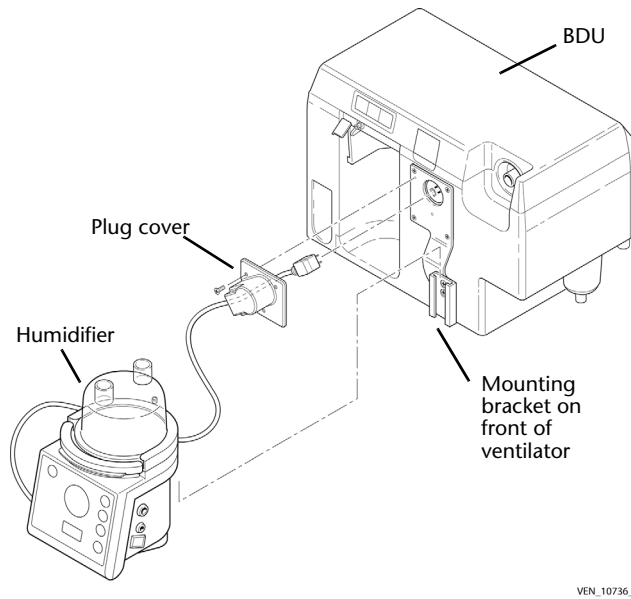

VEN_10736_A

Figure 2-12. How to install the humidifier (Fisher & Paykel version shown) for ventilators mounted on RTA carts

2.3.5 How to use the ventilator cart

Three optional carts are available for use with the Puritan Bennett 840 ventilator: the RTA (ready-to-assemble) cart, the Puritan Bennett 800 Series Ventilator Compressor Mount Cart, and the Puritan Bennett 800 Series Ventilator Pole Cart. The RTA cart can be used with the 802 or 803 BPS, and newer Puritan Bennett 800 Series Ventilator Compressor Mount Carts can be used with a BPS having a one-hour battery or an optional four-hour battery. The Puritan Bennett 800 Series Ventilator Pole Cart also has a one-

hour or optional four-hour battery as part of its battery backup system.

Warning

Install only ventilator BDUs with serial numbers starting with 3512 onto the newer Puritan Bennett 800 Series Ventilator Compressor Mount Cart and Puritan Bennett 800 Series Ventilator Pole Cart. Other ventilator serial numbers are not compatible with the newer carts.

The Puritan Bennett 800 Series Ventilator Compressor Mount Cart cart and Puritan Bennett 800 Series Ventilator Pole Cart may not be available in all regions. Please contact your local Puritan Bennett representative for more information.

To locate the cart's lot number, a label is applied underneath the cart handle on the cart's spine weldment (Figure 2-13).

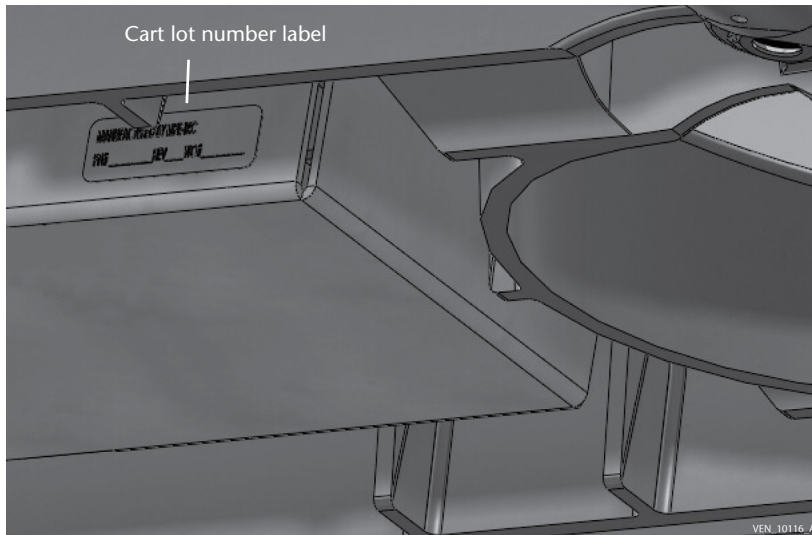

Figure 2-13. Location of cart lot number label

Warning

Lock the cart's wheels prior to installing or removing ventilator components.

Figure 2-14 and Figure 2-15 show how to lock and unlock the cart's front wheels.

Warning

To avoid interrupted ventilator operation or damage to ventilator components, use the cart to move the ventilator. Do not use the cables, the power cord, GUI, or patient circuit components to push or pull the ventilator.

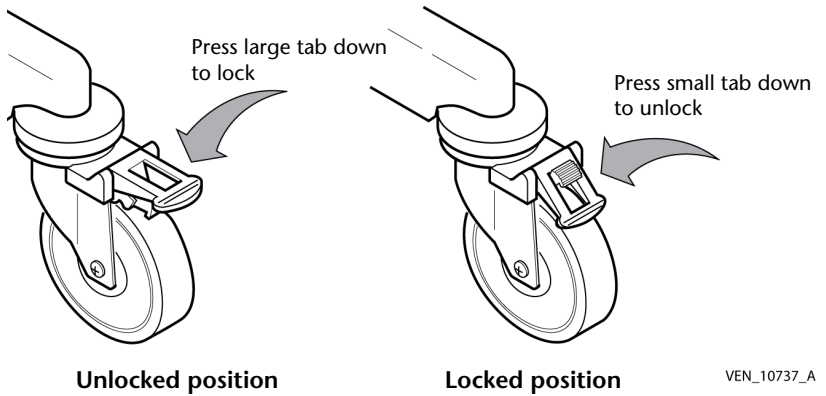

Figure 2-14. How to lock and unlock the RTA cart's front wheels

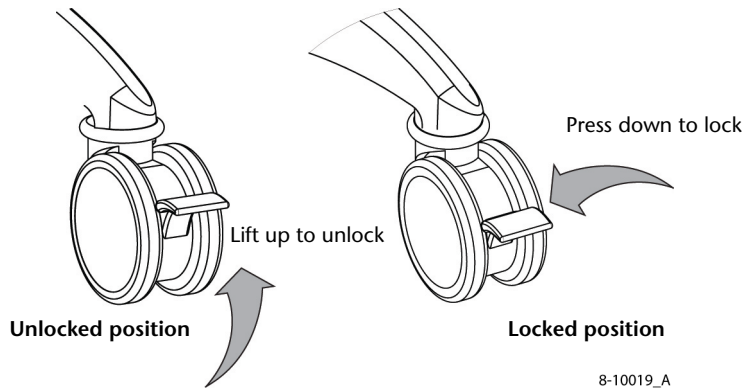

Figure 2-15. How to lock and unlock the Puritan Bennett 800 Series Ventilator Compressor Mount Cart or Puritan Bennett 800 Series Ventilator Pole Cart front wheels

This page is intentionally blank.

How to run Short Self Test (SST)

Chapter 3 tells you:

- When to run SST
- Required equipment for SST
- How to set up and run SST
- The SST tests and their functions
- How to understand the results of SST

3.1 Introduction to SST

SST uses an internal, programmed sequence of tests to:

- Verify proper function of the flow and pressure sensors
- Check the patient circuit for gas leaks
- Measure the expiratory filter resistance
- Measure patient circuit resistance
- Measure patient circuit compliance

SST requires approximately three minutes to complete.

Warning

- Always disconnect the ventilator from the patient before you run SST. If you run SST while the ventilator is connected to the patient, physical injury to the patient may occur.
 - An ALERT reported by SST indicates the ventilator or a related component has a defect. Repair the ventilator or related component before you use the ventilator on a patient, unless you can determine with certainty the defect cannot create a hazard for the patient, or add to the risks that may occur from other hazards.
 - When you run SST, configure the patient circuit exactly as it will be used on the patient (for example, with same accessories). If you add accessories to the patient circuit *after* you run SST, you must rerun SST with the new accessories installed before you begin to ventilate the patient.
-

3.2 When to run SST

NOTE:

Puritan Bennett recognizes health care institutions may have their own ventilator protocols. However, Puritan Bennett is not responsible for the effectiveness of any institution's protocols. Nor can Puritan Bennett specify, or require, specific practices to meet the internal needs of every health care institution.

Puritan Bennett recommends running SST when one or more of the events below occurs:

- When you replace the patient circuit and the exhalation filter after 15 days of use
- When you are ready to connect a new patient to the ventilator
- When you connect a different patient circuit to the ventilator
- When you install a new or sterilized expiratory filter
- When you change the patient circuit type
- When you change the humidification device type
- When you remove or add accessories to the patient circuit, such as a humidifier, water trap, or drain bag

Use SST at any time, provided a patient is *not* attached to the ventilator, to:

- Check the patient circuit for gas leaks
- Calculate patient circuit compliance and resistance
- Calculate expiratory filter resistance

After SST begins, the system prompts you to prepare the ventilator to conduct certain tests. The system waits indefinitely at a prompt until you take action and respond appropriately.

3.3 SST components and requirements

When you conduct SST, you must have available the components and equipment you will use on the patient:

- Patient tubing
- Expiratory filter and collector vial
- Inspiratory filter
- Humidifier, as applicable
- Other accessories (e.g. water traps, drain bag), as applicable

Additional requirements include:

- A No. 1 rubber stopper to block the airway at the patient wye
- Two gas sources (air and oxygen) connected to the ventilator
- Each gas source pressure must be between 35-100 psi (241 to 690 kPa)

Caution

- *To prevent SST failures due to leaks, ensure any circuit components such as collector vial drain port cap (if not using a drain bag), the seal between the expiratory filter and collector vial, and water trap (if used) seals are properly installed.*
 - *If you are using a drain bag, ensure the tubing is properly installed on the collector vial drain port and the tubing is clamped. If the drain bag tubing is not clamped during SST, large leaks and large compliance values are possible which may cause SST to report ALERTs or FAILURES.*
-

Wait at least ten minutes after you turn on the ventilator before you run SST. The warm up time of ten minutes will stabilize the ventilator and ensure the accuracy of the SST tests.

3.4 SST Procedure

Warning

Always disconnect the ventilator from the patient before you run SST. If you run SST while the ventilator is connected to the patient, physical injury to the patient may occur.

- 1 Turn the power switch (located on the front of the BDU). The system conducts the POST (power-on self test) and displays the *Ventilator Startup* screen.
- 2 Allow the ventilator to stabilize for ten minutes with the power on.
- 3 Install the patient circuit, the expiratory and inspiratory filters you will use to ventilate the patient.

Caution

The patient circuit must be unobstructed and properly connected to the ventilator to ensure accurate circuit resistance measurement.

- 4 At the *Ventilator Startup* screen, touch the SST button (lower touch screen), then press the TEST button (on the left side of the BDU) within five seconds. (Refer to Figure 3-1 for location of TEST button.)
The system displays the *SST Setup* screen (lower touch screen).

NOTE:

You must press the TEST button within five seconds of touching the SST button or SST will not start.



Figure 3-1. Test button location

Caution

Do not press the test button when powering up the ventilator. This may cause the ventilator to enter Service Mode. If you enter Service Mode, do not attempt to run Extended Self Test (EST) with a patient circuit. Doing so will cause EST to fail. If EST fails, the ventilator will remain in a Vent Inop state until EST successfully passes.

If you accidentally enter Service Mode, exit Service Mode by touching the EXIT button on the lower GUI screen and then pressing the ACCEPT key.

- 5 Touch the PATIENT CIRCUIT key in the lower touch screen, then use the knob to select either Adult, Pediatric, or Neonatal (if *NeoMode* software option is installed) patient circuit.
- 6 Touch the HUMIDIFICATION TYPE key in the lower touch screen, then use the knob to select the humidification type you will use for patient ventilation.
If you will not use a humidifier, set the humidification type to HME.
- 7 Press ACCEPT to complete your selection of the patient circuit and humidification types.

Warning

Incorrectly specifying the patient circuit type or changing the patient circuit type after you have run SST can affect the accuracy of the compliance calculation, the measured exhaled tidal volume, and delivered/measured inspired tidal volumes. You must rerun SST when you change the circuit type.

Compliance calculation and tidal volume accuracy may also be affected by incorrectly specifying or changing the humidifier after running SST. If you change humidifiers, ensure you change the humidification type as described in Section 4.8. For optimum accuracy, rerun SST using the new humidifier.

- 8 The ventilator automatically starts the test sequence. Refer to Table 3-1 for details regarding each SST test step.

The SST *Flow Sensor*, *Expiratory Filter*, *Circuit Resistance*, and *Compliance Calibration* tests require your intervention. The system will wait indefinitely for your response. Otherwise you don't need to do anything unless a test result is ALERT or FAILURE, or SST is complete.

- 9 As each test is performed, the *SST Status* screen shows test results (see Table 3-2).

Warning

To ensure reliable SST results, *do not* repeat an individual test with a different patient circuit if the test result is **FAILURE** or **ALERT**. If you suspect a defective patient circuit, replace the patient circuit and restart SST from the beginning.

- 10 You can touch EXIT SST during SST to halt testing. You can touch EXIT SST again to resume testing, or press ACCEPT to restart the ventilator (if SST has not detected an ALERT or FAILURE).

Warning

To ensure correct compensation for circuit resistance and compliance, *do not* exit SST until the entire SST is successfully completed. Do not begin normal ventilation until the entire SST is successfully completed with the correct patient circuit installed.

- 11 When all of the tests in SST are complete, the *SST Status* screen displays all individual test results and SST outcome. Table 3-3 summarizes overall SST outcomes and how to proceed in each case.
- 12 To begin normal ventilation (if SST has not detected an ALERT or FAILURE), touch EXIT SST, then press ACCEPT.
- 13 The ventilator reruns POST.
- 14 The ventilator displays the *Ventilator Startup* screen. Proceed with *Ventilator Startup* to configure the system for the patient.

Table 3-1: SST test sequence

Test step	Function	Comments
<p><i>SST Setup</i></p>	<p>The system prompts you to specify the patient circuit type and humidification type you will use for patient ventilation.</p>	<ol style="list-style-type: none"> 1 Specify the patient circuit type. 2 Specify the humidification type. <p>You can select one of three humidification types:</p> <ul style="list-style-type: none"> • Heated expiratory tube • Non-heated expiratory tube • HME (heat-moisture exchanger) <ol style="list-style-type: none"> 3 For non-HME humidifiers, specify the dry humidifier volume. Use the specified volume, not the compressible volume, of the humidifier. 4 Press the ACCEPT key. <hr/> <p>Warning</p> <p>Select the correct patient circuit type and humidification type. Otherwise, faulty occlusion detection and erroneous expiratory spirometry can result.</p> <hr/>
<p>NOTE: The HUMIDIFIER VOLUME button is not visible on the touch screen if you select <i>HME</i>.</p> <hr/>		

Table 3-1: SST test sequence (cont)

Test step	Function	Comments
<p><i>SST Flow Sensor Test</i></p>	<p>The system prompts you to connect the patient circuit to inspiratory filter. Use Figure 2-7 on page OP 2-17 to connect the patient circuit.</p>	<p>1 Connect the patient circuit to the inspiratory filter—but without the humidifier. 2 Press ACCEPT to begin the test.</p>
	<p>NOTE: Do not run the <i>Flow Sensor Test</i> with a humidifier installed, even if you will use a humidifier when you begin patient ventilation.</p>	
	<p>The system prompts you to block the patient wye.</p>	<p>3 Block the wye with a No. 1 stopper. 4 Press ACCEPT.</p>
	<p>The system checks the accuracy of the inspiratory and expiratory flow sensors. After the test completes, the system prompts you to connect the humidifier.</p>	<p>If the status of the <i>SST Flow Sensor Test</i> is FAILURE, you cannot use the OVERRIDE function.</p>
<p>NOTE: If you will use a humidifier during patient ventilation, connect the humidifier to the patient circuit after the system passes the <i>SST Flow Sensor Test</i>. Refer to Figure 2-7 on page OP 2-17 for connection information.</p>		
<p><i>Circuit Pressure Test</i></p>	<p>The system verifies proper function of the BDU pressure sensors.</p>	<p>If the status of the <i>Circuit Pressure Test</i> is FAILURE, you cannot use the OVERRIDE function.</p>

Table 3-1: SST test sequence (cont)

Test step	Function	Comments
<i>Circuit Leak Test</i>	The system determines the ability of the circuit to hold pressure.	If the system reports ALERT and you choose to override the alert status, the result can be improper compliance compensation, inaccurate tidal volume delivery, or autotriggering during patient ventilation. If the test detects excessive leaks, the system reports a FAILURE.
	The system displays the drop in circuit pressure over a 10 second interval.	
<i>Expiratory Filter Resistance Test</i>	The system prompts you to detach circuit tubing from the expiratory filter.	<ol style="list-style-type: none"> 1 Detach the patient circuit from the expiratory filter. 2 Press ACCEPT to begin the test.
	At the conclusion of the <i>Expiratory Filter Resistance Test</i> , the system displays the pressure drop across the expiratory filter.	<p>If the system reports an ALERT for the <i>Expiratory Filter Resistance Test</i> and you override the ALERT, an inaccurate patient pressure estimation can result.</p> <p>The system will report a FAILURE if the test detects an exhalation compartment occlusion or an expiratory filter occlusion.</p> <p>If you do not correctly follow the prompts to disconnect and connect the patient circuit, the system will report a FAILURE.</p>

Table 3-1: SST test sequence (cont)

Test step	Function	Comments
<i>Expiratory Filter Resistance Test (cont)</i>	The system prompts you to reattach the patient circuit.	<p>3 Reattach the patient circuit to the expiratory filter.</p> <p>4 Press ACCEPT to begin the next test.</p>
<i>Circuit Resistance</i>	The system prompts you to unblock the patient wye.	<p>1 Remove the stopper from the wye.</p> <p>2 Press ACCEPT to begin the test.</p>
	<p>The system displays the pressure drop across the inspiratory and expiratory limbs.</p> <p>The reported pressure drop includes the effect of all devices installed on each limb, such as filters, water traps, or a humidifier.</p>	<p>If the system reports an ALERT for the pressure drop across the two limbs and you override the ALERT, an inaccurate patient pressure estimation can result.</p> <p>The system reports a FAILURE if the test detects excessive high or low limb resistance, or if you do not follow the prompt to unblock the wye.</p>

Table 3-1: SST test sequence (cont)

Test step	Function	Comments
<i>Compliance Calibration</i>	The system prompts you to block the patient wye. If you selected a humidification type of either <i>Heated exp tube</i> or <i>Non-heated exp tube</i> , the ventilator prompts you to indicate if there is water in the humidifier.	<ol style="list-style-type: none"> 1 Block the wye with a No. 1 stopper. 2 Press ACCEPT to begin the patient circuit compliance test. 3 Press ACCEPT to indicate YES or CLEAR to indicate NO, as appropriate, to indicate whether or not there is water in the humidifier.
	The system displays the compliance of the patient circuit.	<p>If the system reports an ALERT for the patient circuit compliance and you override the ALERT, improper compliance compensation or inaccurate tidal volume delivery can result.</p> <p>The system reports a FAILURE if the test detects an out-of-range compliance condition.</p>
	The system prompts you to unblock the patient wye.	<ol style="list-style-type: none"> 4 Remove the stopper from the patient wye. 5 Press ACCEPT to complete the SST test sequence.

3.5 SST Results

The Puritan Bennett™ 840 Ventilator System uses four status categories to characterize the individual SST test results, and the overall SST outcome.

ALERT

You can override an ALERT reported for an individual test if you can determine with certainty the defect in the ventilator or related component cannot create a hazard for the patient, or add to the risks arising from other hazards.

NOTE:

If an ALERT is reported and you exit SST without overriding the ALERT, the ventilator will enter the safety valve open (SVO) state and cannot be used for normal ventilation until SST passes or the ALERT is overridden.

FAILURE

When the system declares a FAILURE for an individual test in the SST sequence, the ventilator enters the SVO state. When a ventilator experiences a FAILURE, immediately remove the equipment from clinical use until qualified service personnel have completed and verified the necessary repairs.

OVERRIDDEN

OVERRIDDEN is a final status of the overall SST outcome and indicates you used the override feature when the system reported an ALERT condition. (The ventilator must have ended the test with an ALERT condition.)

PASS

PASS is the final status of the overall SST outcome in which no alerts or failures were detected.

Refer to Table 3-2 and Table 3-3 to learn how to interpret and respond to each of these SST status categories.

3.5.1 How to interpret individual SST test results

SST reports a test result status for each of the individual tests. Use Table 3-2 to interpret SST test results and to determine how to respond.

Table 3-2: Individual SST test results

If the test status is:	It means:	Do this:
PASSED	The system did not detect a fault for the individual test.	You do not need to do anything, unless you are prompted by the ventilator.
ALERT	<p>The test result is not ideal, but is not critical.</p> <p>If SST is in progress, it halts further testing and prompts you to make a decision.</p>	<p>When the system prompts you, touch one of these buttons, then press ACCEPT:</p> <div style="display: flex; flex-direction: column; gap: 10px;"> <div data-bbox="646 634 793 683"> <div style="border: 1px solid black; padding: 2px 10px; display: inline-block;">EXIT SST</div> Discontinue SST </div> <div data-bbox="646 716 793 764"> <div style="border: 1px solid black; padding: 2px 10px; display: inline-block;">RESTART SST</div> Repeat SST from the beginning </div> <div data-bbox="646 797 793 846"> <div style="border: 1px solid black; padding: 2px 10px; display: inline-block;">NEXT</div> Proceed to the next test </div> <div data-bbox="646 878 793 927"> <div style="border: 1px solid black; padding: 2px 10px; display: inline-block;">REPEAT</div> Repeat the test </div> </div>
FAILURE	A critical problem has been detected, and SST cannot complete until the ventilator passes the failed test.	<p>Touch one of these buttons, then press ACCEPT:</p> <div style="display: flex; flex-direction: column; gap: 10px;"> <div data-bbox="646 1049 793 1097"> <div style="border: 1px solid black; padding: 2px 10px; display: inline-block;">EXIT SST</div> Discontinue SST </div> <div data-bbox="646 1130 793 1179"> <div style="border: 1px solid black; padding: 2px 10px; display: inline-block;">RESTART SST</div> Repeat SST from the beginning </div> <div data-bbox="646 1211 793 1260"> <div style="border: 1px solid black; padding: 2px 10px; display: inline-block;">REPEAT</div> Repeat the test </div> </div>

3.5.2 SST outcomes

When SST has completed all of the tests, use Table 3-3 to determine how to proceed.

Table 3-3: Overall SST outcomes

If the SST outcome is:	It means:	Do this:
PASSED	All tests passed.	<p>Touch one of these buttons, then press ACCEPT:</p> <div style="display: flex; flex-direction: column; gap: 10px;"> <div style="display: flex; align-items: center;"> <div style="border: 2px solid black; padding: 5px; margin-right: 10px;">EXIT SST</div> <p>Exit SST and begin normal ventilation</p> </div> <div style="display: flex; align-items: center;"> <div style="border: 2px solid black; padding: 5px; margin-right: 10px;">RESTART SST</div> <p>Repeat SST from the beginning</p> </div> </div>
ALERT	One or more faults were detected. If you can determine with certainty this cannot create a hazard for the patient, or add to the risks which may arise from other hazards, you can choose to override the ALERT status and authorize ventilation.	<p>Touch one of these buttons, then press ACCEPT:</p> <div style="display: flex; flex-direction: column; gap: 10px;"> <div style="display: flex; align-items: center;"> <div style="border: 2px solid black; padding: 5px; margin-right: 10px;">EXIT SST</div> <p>Discontinue SST</p> </div> <div style="display: flex; align-items: center;"> <div style="border: 2px solid black; padding: 5px; margin-right: 10px;">RESTART SST</div> <p>Repeat SST from the beginning</p> </div> <div style="display: flex; align-items: center;"> <div style="border: 2px solid black; padding: 5px; margin-right: 10px;">OVERRIDE</div> <p>Press ACCEPT to override the ALERT, as allowed by your institution's protocol. Touch EXIT SST, then press ACCEPT to begin normal ventilation.</p> </div> </div>
FAILURE	One or more critical faults were detected. The ventilator enters the SVO state and cannot be used for normal ventilation until SST passes. Service is required.	<p>Restart SST with a different patient circuit. Touch one of these buttons, then press ACCEPT:</p> <div style="display: flex; flex-direction: column; gap: 10px;"> <div style="display: flex; align-items: center;"> <div style="border: 2px solid black; padding: 5px; margin-right: 10px;">EXIT SST</div> <p>Discontinue SST</p> </div> <div style="display: flex; align-items: center;"> <div style="border: 2px solid black; padding: 5px; margin-right: 10px;">RESTART SST</div> <p>Press ACCEPT to repeat SST from the beginning. If the failure persists, contact qualified service personnel.</p> </div> </div>

Chapter 4 tells you:

- How the Puritan Bennett™ 840 Ventilator System user interface is structured
- How to start up the ventilator for a new or previous patient
- How to change main settings
- How to change other settings
- How to set the humidification type, expiratory sensitivity, and disconnect sensitivity
- How to enable or disable the oxygen sensor
- How to select and set the variable that remains constant when the breath rate setting is changed
- How to set the alarm limits
- How to perform inspiratory and expiratory pause maneuvers
- How to interpret inspiratory pause maneuver displays
- How to use Non-invasive ventilation (NIV)

NOTE:

The *DualView* touch screens use light beams to detect where you touch the screen. To avoid a DEVICE ALERT alarm, do not place any foreign substances or objects on the screen.

4.1 Structure of user interface

The following buttons are available on the upper and lower touch screens. These buttons appear across the bottom portion of each of the two touch screens.

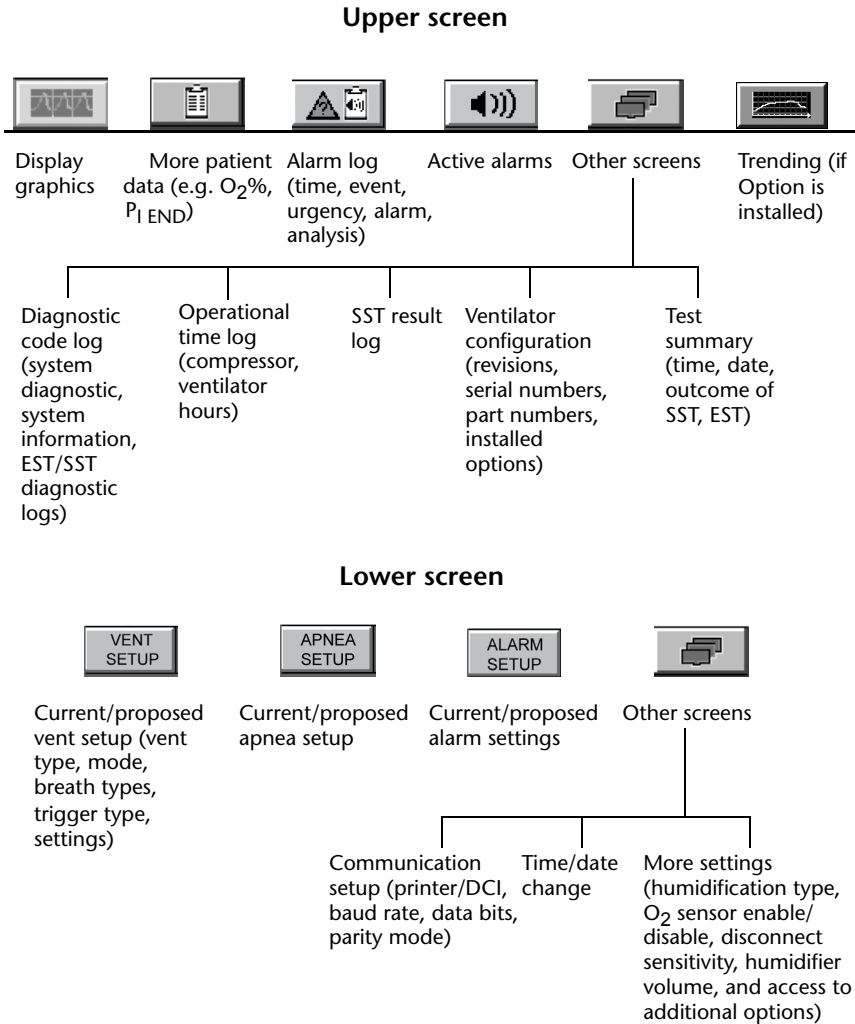



Figure 4-1. Touch screen user interface

4.2 Patient setup

Warning

Always complete the patient setup before you attach a patient to the ventilator. If you attach a patient before the setup procedure is complete, the ventilator issues a procedure error and initiates the safety ventilation mode.

When you turn on the ventilator, the ventilator automatically runs POST (Power On Self Test). After POST passes, the system displays the **Ventilator Startup** screen (Figure 4-2) on the lower screen. The prompt area, located in the lower right corner of the lower screen, contains setup instructions.

SIMV	VC		TC	P-TRIG	50 kg
f 16 $\frac{1}{\text{min}}$	V _T 365 mL	V _{MAX} 22 $\frac{\text{L}}{\text{min}}$	% Supp 100 %	P _{SENS} 2.0 $\frac{\text{cm}}{\text{H}_2\text{O}}$	O ₂ 100 %
	T _{PL} 0.0 s	 SQUARE		E _{SENS} 10 %	PEEP 3.0 $\frac{\text{cm}}{\text{H}_2\text{O}}$

Ventilator Startup

SAME
PATIENT

Ventilate with previous settings (shown above).
→ Note tube I.D. = 8.0mm, tube type = ET.

NEW
PATIENT

Initiate new patient setup.

SST

Perform Short Self Test (SST) and calibrate circuit.

Make a selection.
Complete Ventilator Startup **BEFORE** attaching patient!

YBL_10739_A

Figure 4-2. Ventilator Startup screen

4.2.1 How to ventilate with most recent control parameters

To continue ventilation with the most recent ventilator control parameters, touch **Same Patient** and press ACCEPT. Ventilation does not begin until a patient is connected. A flashing reminder arrow prompts you to consider the previous tube ID and tube type if the prior Spontaneous Type used these parameters.

4.2.2 How to ventilate with new control parameters

Refer to Table A-13 in Appendix A for the descriptions, ranges, resolutions, accuracies, and new patient values of the available ventilator control parameters.

1. Touch the **New Patient** button to select new ventilator control parameters for patient ventilation.

If you want to return to the **Ventilator Startup** screen, touch the RESTART button.

2. The system displays the **New Patient Settings** screen with the following buttons, and uses the rotary knob or drop-down menus to display the available selections.

IBW: Ideal body weight: Turn the knob to adjust the IBW. The proposed value is highlighted.

Warning

Always enter the IBW appropriate for the patient. The system uses the patient's IBW to automatically set certain values, alarm limits, and parameter boundary limits for several initial parameters. (The IBW values correlated with patient height are listed in Table 4-1.) If you are changing IBW to a new value, all settings not currently applicable shall be automatically adjusted, if necessary, to their New Patient value or to the minimum or maximum allowable value for the new IBW.

Vent Type: Determines the ventilation type

- INVASIVE — conventional ventilation using either endotracheal (ET) or tracheostomy (trach) tubes
- NIV (non-invasive) — ventilation using full-face masks, nasal masks, infant nasal prongs, or uncuffed ET tubes (see Section 4.12 for specific information on how to use NIV)

Mode: Determines the type and sequence of breath delivery

- A/C (Assist/Control)
- SIMV (Synchronous Intermittent Mandatory Ventilation)
- SPONT (Spontaneous)
- CPAP (Continuous Positive Airway Pressure, available only with NeoMode software option when Vent Type is NIV)
- BILEVEL (available only with *BiLevel* software option when Vent Type is INVASIVE)

Mandatory Type: Determines the type of mandatory breath control

- PC (Pressure Control)
- VC (Volume Control)

- VC+ (Volume Control Plus available only with the *Volume Ventilation Plus (VV+)* software option when **Vent Type** is INVASIVE)

(If the selected **Mode** is SPONT, the **Mandatory Type** applies to manual inspirations only.)

Spontaneous Type: Determines type of support for spontaneous breaths

- PS (Pressure Support)
- TC (Tube Compensation available only with the *TC* software option when Vent Type is INVASIVE)
- VS (Volume Support available only with the *VV+* software option when Vent Type is INVASIVE)
- PA (Proportional Assist available only with the *PAV+* software option when Vent Type is INVASIVE)
- NONE

(If the selected **Mode** is A/C, the **Spontaneous Type** button does not appear.)

Trigger Type: Determines the method used to detect patient inspiratory effort

- P-TRIG (Pressure) (not available when Vent Type is NIV or when using the *NeoMode* option)
- \dot{V} -TRIG (Flow)

3. Touch the button and turn the knob to adjust the desired settings. When you complete your settings changes, touch CONTINUE. (You must touch the IBW button first before the CONTINUE button will display.)

Touch the button and turn the knob to adjust the desired settings. When you complete your settings changes, touch CONTINUE.

- 4 The final **New Patient Settings** screen appears. Touch the button of each parameter you want to change, then turn the knob to select its value. To cancel this change, press the CLEAR key. To cancel all changes and start over, touch the RESTART button.

NOTE:

The ventilator control parameter you are setting may be dependent upon other ventilator settings that determine its boundaries. Refer to the prompt area on the lower GUI screen (Figure 1-2) for more information.

- 5 Press ACCEPT to put all of your ventilation control settings into effect. Normal ventilation begins once a patient is connected.
- 6 The **Apnea Setup** screen appears. Apnea settings are automatically determined based on IBW, circuit type, and mandatory breath type, but you can change them. If you change any apnea settings, press ACCEPT to apply.
Although you are not required to change or confirm apnea settings, you should verify they are appropriate for the patient prior to ventilation.
- 7 Press the ALARM SETUP button to review the current alarm limit settings on the **Alarm Settings** screen. Ensure they are appropriate for the patient. To change any limit, touch the button and turn the knob. To cancel, touch PROPOSED ALARM. To apply the settings, press the ACCEPT key.

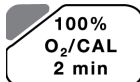

You may choose to calibrate the ventilator's oxygen sensor at this point. Press the **100% O₂ / CAL 2 min** or **INCREASE O₂ 2 min** key located on the keyboard below the touch screens. See page TR 15-6 for more information on calibrating the oxygen sensor.



During the oxygen sensor calibration, the ventilator delivers 100% oxygen (if available) for two minutes and calibrates the oxygen sensor in the Breath Delivery Unit (BDU).

The ventilator always monitors the delivery of oxygen to the patient unless you disable the oxygen sensor. Touch the MORE SETTINGS button to access oxygen sensor disable or enable functions.

- 8 After you accept the ventilation control parameters, you can attach a patient to the ventilator. Ventilation only begins when the ventilator senses a patient is attached.
If you attach a patient before completing setup, the ventilator initiates safety ventilation mode and annunciates a

PROCEDURE ERROR alarm that is reset once you complete the patient setup.

Warning

Each patient circuit type is appropriate for a specified range of IBW values. This information is summarized in Table 4-3.

The recommended ranges exist to ensure patient safety. Only those with expertise to judge the appropriate circumstances should override the recommended ranges.

4.2.3 Patient data and current settings

The top of the upper screen shows vital patient data. (Out-of-range data flashes to alert you.) The current breath type is indicated in the upper left corner:

- **C** = Control
- **S** = Spontaneous
- **A** = Assist



You can access additional patient data when you touch the MORE PATIENT DATA button.

You can display the definitions for any symbol used in the patient data, alarm log, or settings areas by touching the symbol. The symbol definitions appear at the bottom of the lower touch screen.

Current ventilator control settings are displayed across the top of the lower touch screen (Figure 4-3). If you press the *100% O₂/CAL 2 min* key or the *INCREASE O₂ 2 min* key, the lower touch screen automatically displays the IN PROGRESS indicator. If you touch the *Alarm Silence* key, the IN PROGRESS indicator will appear if there is no other higher-priority display active. Press the CANCEL button for either indicator to cancel the alarm silence or oxygen sensor calibration in progress.

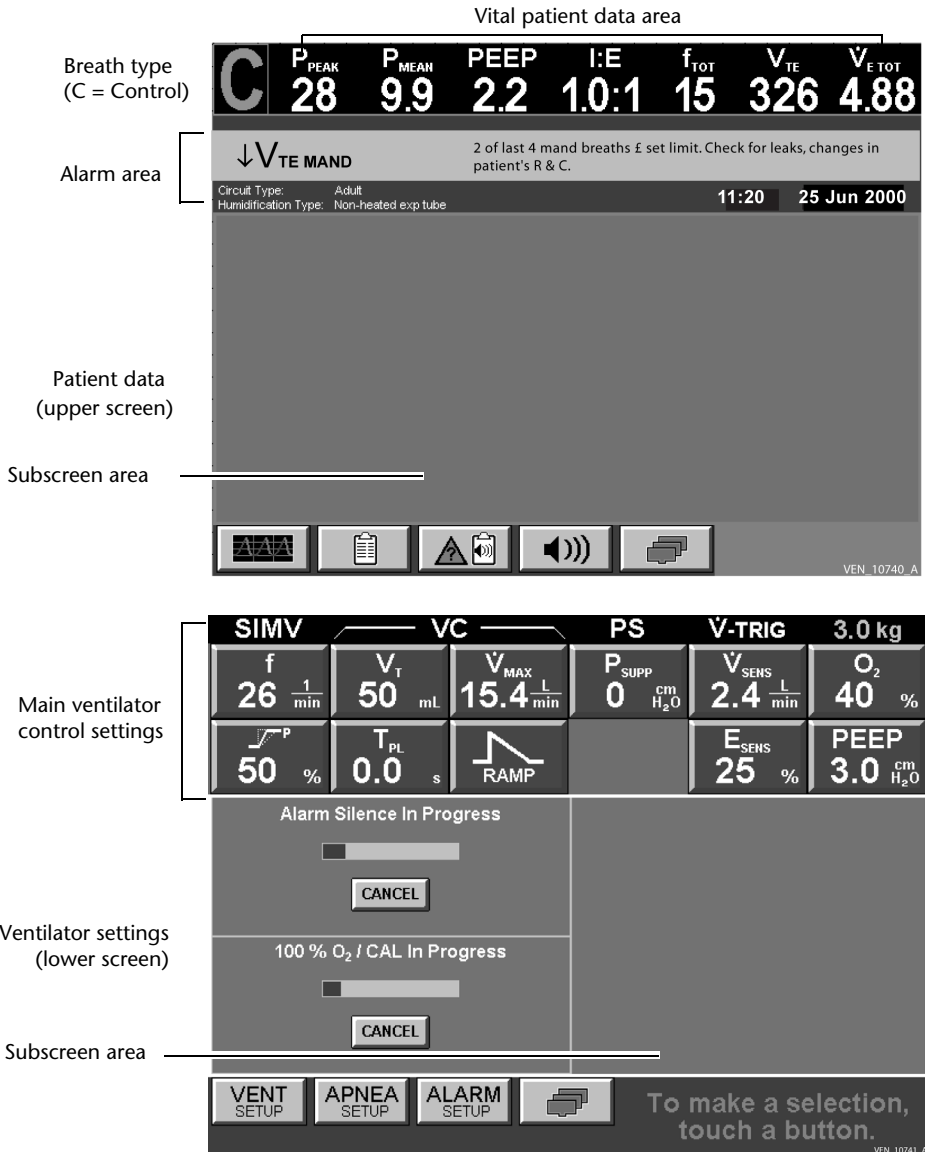

Figure 4-3. Touch screen appearance during normal ventilation (shown with alarm silence and 100% O₂/CAL in progress)

4.2.4 Ideal Body Weight (IBW)

The system initially sets most upper and lower alarm limits based on the patient's IBW. After entering the IBW, review and change these alarm settings as needed. Table 4-1 below provides the information needed to determine the patient's IBW using the patient's height.

Table 4-1: Ideal Body Weight (IBW) based on patient height

Patient height		IBW (lb)
ft	in	
1	9	8
1	10	9
1	11	10
2	0	11
2	1	13
2	2	14
2	3	15
2	4	17
2	5	18
2	6	19
2	7	21
2	8	22
2	9	24
2	10	26
2	11	29
3	0	31
3	1	33
3	2	35
3	3	37
3	4	40
3	5	42

Patient height		IBW (lb)
ft	in	
3	6	44
3	7	46
3	8	49
3	9	51
3	10	53
3	11	57
4	0	60
4	1	62
4	2	66
4	3	68
4	4	71
4	5	75
4	6	79
4	7	82
4	8	86
4	9	90
4	10	93
4	11	97
5	0	101
5	1	104
5	2	108

Table 4-1: Ideal Body Weight (IBW) based on patient height (cont)

Patient height		IBW (lb)
ft	in	
5	3	112
5	4	117
5	5	121
5	6	126
5	7	130
5	8	134
5	9	141
5	10	146
5	11	150
6	0	154
6	1	161
6	2	165
6	3	172
6	4	176
6	5	183
6	6	187
6	7	194
6	8	201
6	9	207
6	10	212
6	11	218
7	0	225

Patient height		IBW (lb)
ft	in	
7	1	231
7	2	238
7	3	245
7	4	251
7	5	258
7	7	269
7	8	278
7	9	287
7	10	293
7	11	300
8	0	309
8	1	317
8	2	324
8	3	331

The New Patient tube ID value is the high value tube ID for the chosen IBW in Table 4-2

Table 4-2: Soft bound ranges for Ideal Body Weight (IBW) and tube Internal Diameter (ID)

IBW (kg)	Low value tube ID in mm	High value tube ID in mm
< 7.0	At this IBW, tube ID is not an allowable setting	At this IBW, tube ID is not an allowable setting
7-10	NONE	4.5
11-13	NONE	5.0
14-16	NONE	5.5
17-18	NONE	6.0
19-22	5.0	6.0
23-24	5.0	6.5
25-27	5.5	6.5
28-31	5.5	7.0
32-35	6.0	7.0
36	6.0	7.5
37-42	6.5	7.5
43-49	6.5	8.0
50	7.0	8.0
55	7.0	8.5
60	7.0	9.0

Table 4-2: Soft bound ranges for Ideal Body Weight (IBW) and tube Internal Diameter (ID) (cont)

IBW (kg)	Low value tube ID in mm	High value tube ID in mm
65	7.5	9.0
70	7.5	9.5
75	8.0	9.5
80-100	8.0	NONE
110-130	8.5	NONE
140-150	9.0	NONE

The patient circuit type you specify during SST determines several default settings and the ranges available for ventilator operation (Table 4-3).

Table 4-3: Patient circuit and IBW values

Recommendation	Ideal body weight (IBW) in kg (lb)
Recommended	Neonatal patient circuit: 0.3-7.0 kg (0.66-15 lb) ^{1*} Pediatric patient circuit: 7.0-24 kg (15-53 lb) Adult patient circuit: 25-150 kg (55-330 lb) *IBW range assumes NeoMode 2.0 software option is installed
Allowed but not recommended (operator override required)	Neonatal patient circuit: Not applicable. Pediatric patient circuit: 3.5-6.5 kg (7.7-14.3 lb) and 25-35 kg (55-77 lb) Adult patient circuit: 7.0-24 kg (15-53 lb)

1. To use a neonatal patient circuit, the ventilator must have both the *NeoMode* software option and the *NeoMode* hardware installed.

4.3 How to change the main ventilator control parameters

The main ventilator control parameters are the buttons displayed at the top of the lower screen. Follow these steps to change main parameters:

- 1 Touch button of the parameter you want to change.
- 2 Turn the knob to set the desired value. To cancel this change, press the CLEAR key to go back to the previous value.
- 3 Repeat steps 1 and 2 for each parameter you want to change.
- 4 To cancel your changes, press the CANCEL ALL button, or press ACCEPT to apply the new ventilator control parameter(s).

The lower screen displays monitored control parameters (Table 4-4) if you select or change other control parameters that affect them.

Table 4-4: Monitored ventilator control parameters

Set minute volume ($\dot{V}_{E\ SET}$)	Displayed along with the breath timing bar whenever you select or change the respiratory rate (f) or volume control parameters.
Volume per weight ratio (V_T/IBW)	Displayed when you select or change the tidal volume (V_T , when breath type is VC) or target volume (V_T , when breath type is VC+).
$V_{T\ SUPP}/IBW$	Volume per weight ratio: displayed when you select or change the target support volume ($V_{T\ SUPP}$, when breath type is VS) control parameter.

4.4 Ideal Body Weight (IBW), vent type, mode, and other changes

- 1 Touch the VENT SETUP button on the lower screen. The **Current Vent Setup** screen appears.
- 2 To change ventilation setup (IBW, vent type, mode, mandatory breath type, spontaneous type, or trigger type), *touch* its button then *turn* the knob to set the value. Proposed changes are highlighted. To cancel the change just made, press the CLEAR key to go back to the previous setting. Press PROPOSED SETUP to cancel all changes and start over.
- 3 Once you change IBW, you cannot change the mode, vent type, mandatory type, or spontaneous type, but you can, however, change the trigger type. If you change the IBW back to its original value, you can change any of the main control settings again. Similarly, if you change any of the main control settings, the GUI will prevent you from changing the IBW until you change the main control settings back to their original values. Also, if you are ventilating with TC or PA as the spontaneous type, you must ensure the tube ID specified is appropriate for the new IBW.

NOTE:

- The intent of allowing IBW to be changed was ventilator settings would not be automatically changed. An exception is when tube ID < 6 mm.
- Given the current ventilator settings, if PAV would otherwise be an allowable Spontaneous Type (except that tube ID < 6 mm), then PAV becomes selectable.
- If PAV is selected when tube ID < 6 mm, tube ID shall be automatically set to its New Patient value, based on the new IBW (see Table 4-2 for tube ID ranges corresponding with IBW).

An attention icon for tube ID (whether new or unchanged) displays whenever PAV is selected.

- 4 After making any necessary changes, touch CONTINUE. Appropriate settings for the ventilation setup selected appear on the lower screen.
 - 5 For each ventilator setting you want to change, touch its button, then turn the knob to set its value. To cancel this value, press the CLEAR key. Press PROPOSED SETUP to cancel all changes and start over.
 - 6 After making all necessary changes, review the control parameters, then press ACCEPT to apply all the new control parameters at the same time.
-

NOTE:

Once the changes are in effect, the PREVIOUS SETUP button appears at the bottom of the lower screen when you press VENT SETUP. This allows you to restore the entire previous setup (including alarm and apnea settings) in effect immediately before you made settings changes using the **Ventilator Setup** screen. To restore the previous setup, touch PREVIOUS SETUP, then press ACCEPT.

4.5 How to select a constant timing variable during respiratory rate changes

If Pressure Control (PC) or VC+ is the mandatory breath type in the ventilator setup, or if you have selected BILEVEL mode, you can select one of three available timing variables to be held constant when the respiratory rate setting changes. The selected timing variable is the one held constant during rate changes, and also the only one of the three timing variables you can adjust directly.

The three available timing variables for PC or VC+ mandatory breaths are defined as follows:

- T_I represents the inspiratory time. This timing variable determines the inspiratory interval for PC mandatory breaths.
- I:E represents the inspiratory to expiratory ratio. This timing variable determines the ratio of inspiratory time to expiratory time for PC mandatory breaths.
- T_E represents the expiratory time. This timing variable determines the duration of expiration for PC mandatory breaths.

The three available timing variables for BILEVEL mode are defined as follows:

- T_H represents the time interval for the high PEEP level ($PEEP_H$)
- $T_H:T_L$ determines the ratio of the high PEEP time interval to the low PEEP time interval for *BiLevel* breaths.
- T_L represents the time interval for the low PEEP level ($PEEP_L$).

Follow these steps to view or change the timing variable held constant during respiratory rate changes:

- 1 Touch VENT SETUP.
- 2 Touch CONTINUE. A graphic of the breath timing bar appears in the lower screen, with a lock icon above each of the three timing variables (Figure 4-4).

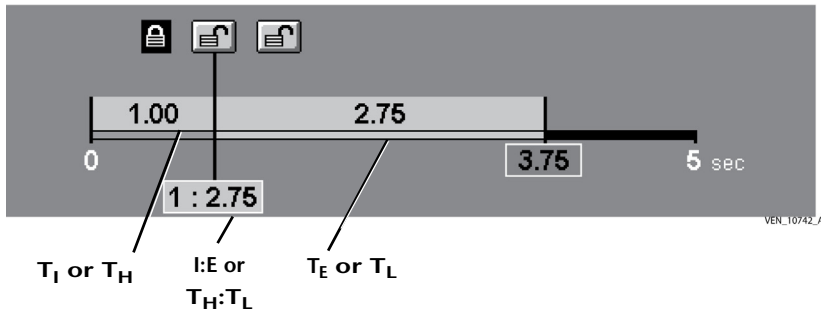

Figure 4-4. T_I (or T_H) selected as the constant during rate change

- 3 Touch the lock icon of the timing variable you want to remain constant when the respiratory rate setting changes. The lock icon of your selection should now be a closed lock, as it appears above the T_I/T_H timing variable in Figure 4-4.
In addition, the current value of your selected timing variable is highlighted within the breath timing graphic, and both this variable name and its current value are displayed in a highlighted box under the ventilator control parameter PC.
- 4 Turn the knob to set the value of your constant timing variable.
- 5 Review the selected timing variable and its value. Make changes if necessary, then press ACCEPT.

NOTE:

You can change the value of the constant timing variable at any time, but the value does not change as a result of changing the respiratory rate setting. For example, if you select T_I to remain constant during rate change, you can still change the value of T_I . Otherwise, the value of T_I does not change (and the values of I:E and T_E do change) when you change the respiratory rate setting. This also holds true for the *BiLevel* variables T_H , $T_H:T_L$, and T_L .

4.6 How to change apnea ventilation settings

- 1 Touch the APNEA SETUP button on the lower screen. The current **Apnea Setup** screen appears.
- 2 If you select the apnea mandatory type setting (CHANGE VC/PC button), a button appears indicating the current mandatory type setting. Touch the button to reveal a drop-down menu of the available selections with the current selection highlighted. If desired, turn the knob to select a new mandatory type, then press CONTINUE to review the settings applicable to the chosen apnea mandatory type.
- 3 For each setting you want to change, touch its button, then turn the knob to set its value. Proposed changes are highlighted. Press PROPOSED APNEA to cancel changes and start over.

NOTE:

The CHANGE VC/PC button disappears when you change other apnea settings until you press the ACCEPT key to apply the changes.

- 4 Once you've made any changes you want, review the settings, then press ACCEPT to apply all the new settings at the same time.

4.7 How to set alarms

The system initially sets most alarm settings based on the patient's IBW. You should review all alarm settings, but you are not required to confirm or change them at startup.

- 1 Touch the ALARM SETUP button (lower screen) to view the current alarm setup (see Figure 4-5). The pointer to the left of each bar shows the current patient data value for each parameter, and highlighted blocks represent the recent range of corresponding patient data. The buttons to the right of each bar show the alarm limit(s) for each parameter.
- 2 Touch the button for each alarm limit you want to change.
- 3 Turn the knob to set the value you want (the active alarm limit button moves up or down with the selected value). Proposed values are highlighted. You can change more than one alarm setting before applying the changes. To cancel the last change made, press the CLEAR key to go back to the previous setting. Press PROPOSED ALARM to cancel all changes and start over.

NOTE:

- You cannot set the upper and lower limits of an alarm to conflict with each other.
 - The upper limits for the spontaneous exhaled tidal volume and mandatory exhaled tidal volume alarms are always the same value. Changing the upper limit of one alarm automatically changes the upper limit of the other.
-

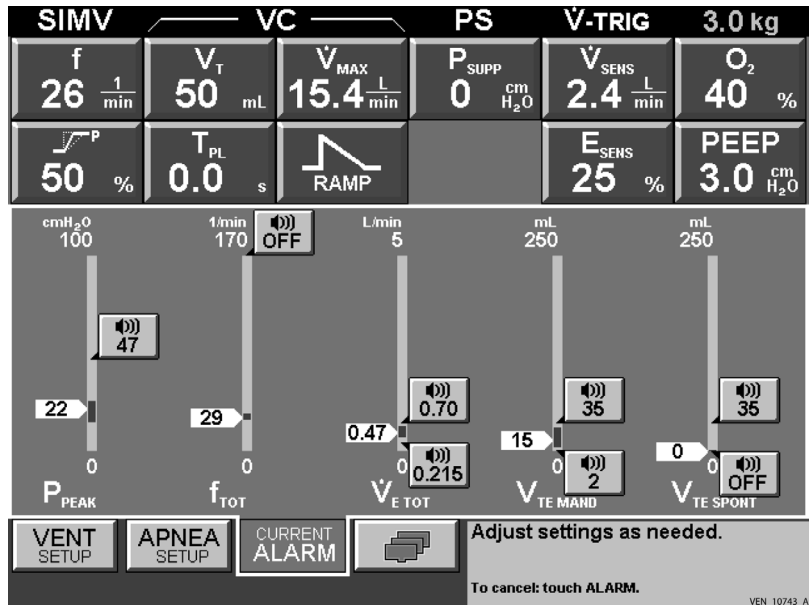

Figure 4-5. Alarm setup

- Once you have made all of the desired changes and have reviewed the settings, press ACCEPT to apply.

You can touch the ALARM SETUP button at any time during ventilation to show the current limits and the monitored patient value (shown inside the white arrows in Figure 4-5) for each alarm limit.

4.8 How to change other settings



The **Other Screens** button allows you to configure the communications (RS-232) ports, set or change the time and date, and access settings for the humidifier, oxygen (O₂) sensor, and disconnect sensitivity.

To configure the communications ports, refer to Appendix E Remote alarm and RS-232 ports.

The **Time/Date Change** button allows you to set the current time of day and calendar date. The date format is selectable and includes a check for correct number of days in a month. For example, you cannot enter February 30. Available date formats are:

- DD MMM 'YY (DD.MM) (default)
- 'YY MMM DD (MM-DD)
- 'YY/MM/DD (MM-DD)
- MM/DD/'YY (MM-DD)
- MM/DD/'YY (MM/DD)
- DD/MM/'YY (DD.MM)

The time is shown in hours and minutes in a 24-hour clock format.

To set or change the time and date:

- 1 Touch the **Other Screens** button, then touch the **Time/Date Change** button.
- 2 Touch the **Date Format** button and turn the knob to select your desired date format.
- 3 Touch the corresponding button and turn the knob to change the values for day, month, year, hour, and minute. To cancel your changes, touch the **Other Screens** button again.
- 4 Press ACCEPT to apply the new settings.

The **More Settings** button leads to settings that usually change infrequently. Three settings, listed below, are available:

- Humidification type
- Oxygen (O₂) sensor
- D_{SENS} (disconnect sensitivity)

To change humidification type, humidifier volume (for non-HME humidifiers, or disconnect sensitivity (D_{SENS}), or to enable or disable the O₂ sensor, and to change tube type or tube ID when using the TC option, follow these steps:

- 1 Touch the **Other Screens** button, then touch the **More Settings** button.
- 2 Touch the button of a parameter you want to change, then turn the knob to set the parameter value. (You can change multiple parameters and then apply the changes all at once.)
For non-HME humidifiers, touch the Humidifier Volume button, then turn the knob to select the dry humidifier volume. (The Humidifier Volume button is not visible when **HME** is selected.)
To leave settings unchanged, touch the **Other Screens** button again.
- 3 Review the proposed parameters.
- 4 Press ACCEPT to apply the new settings.

4.9 Expiratory pause maneuvers

Pressing the EXP PAUSE key seals the breathing circuit during the expiratory phase of a designated breath. The designated breath can be mandatory or spontaneous, and must be followed by a mandatory inspiration. The expiratory pause maneuver allows pressure in the patient's lungs to equilibrate with the pressure in the ventilator breathing circuit, and results in elevated circuit pressure if intrinsic PEEP ($PEEP_I$) is present. An expiratory pause is used to estimate $PEEP_{TOT}$ and $PEEP_I$.

There are two types of expiratory pause maneuvers:

- An *automatic pause* begins when you press the EXP PAUSE key momentarily. An automatic pause maneuver continues until the pressure stabilizes. An automatic expiratory pause lasts at least 0.5 second, but no longer than 3.0 seconds.

An automatic expiratory pause maneuver is most appropriate for patients whose airways remain open throughout exhalation. To cancel an automatic expiratory pause maneuver, press the CANCEL button on the lower screen.

- A *manual pause* begins when you press and hold the EXP PAUSE key down. The manual expiratory pause continues until you release the key, up to a maximum of 20 seconds.

A manual expiratory pause maneuver is most appropriate for patients whose near end-expiratory flow shows signs of obstruction.

The most recently selected graphics are displayed and frozen when an expiratory pause maneuver begins, so you can see when the expiratory pressure stabilizes. At the end of the maneuver, the system displays the values for $PEEP_I$ and $PEEP_{TOT}$.

NOTE:

- If the patient triggers breaths during the waiting period prior to the start of the Expiratory Pause maneuver, the ventilator will wait approximately one minute while it detects the appropriate conditions to start the maneuver. If the conditions are not met during the wait period, the ventilator cancels the maneuver.
 - If the patient initiates a breath or an alarm occurs during the Expiratory Pause maneuver, the ventilator cancels the maneuver, and returns to normal ventilation. A message appears in the graphics display indicating the maneuver has been canceled.
-

4.10 Inspiratory pause maneuvers

When you press the INSP PAUSE key, the breathing circuit seals after the end of the gas delivery phase of a designated, volume- or pressure-based mandatory inspiration. This allows pressure in the lungs to equilibrate with the pressure in the breathing circuit, which results in a pressure plateau. An inspiratory pause maneuver begins at the end of gas delivery (VC breath) or when the set inspiratory time (T_I) elapses (PC or VC+ breath). The maneuver begins at the end of the gas delivery phase of the current or the next breath.

This maneuver allows you to measure the patient's static lung-thoracic compliance (C_{STAT}), static resistance (R_{STAT}), and plateau pressure (P_{PL}), or to maintain the inflated state of the lungs.

There are two types of inspiratory pause maneuver:

- *An automatic pause* begins when you press the INSP PAUSE key momentarily. An automatic pause maneuver continues until the pressure stabilizes, and lasts at least 0.5 second but no longer than 2.0 seconds.

Use an automatic pause to measure C_{STAT} , R_{STAT} (only on square wave, VC breaths), and P_{PL} . To cancel an automatic inspiratory pause maneuver, press the CANCEL button on the lower screen.

- *A manual pause* begins when you press and hold the INSP PAUSE key down, and continues until the INSP PAUSE key is released, up to a maximum of 7 seconds.

Use a manual pause to maintain lung inflation; for example, during an X-ray.

If you select a plateau time (T_{PL}), you can extend the inspiratory pause or T_{PL} . For example, during an automatic pause, T_{PL} can be extended to up to 2.0 seconds. If T_{PL} exceeds 2.0 seconds and the pause maneuver ends before T_{PL} elapses, the plateau lasts the full T_{PL} interval. During a manual pause, the pause lasts the T_{PL} setting or the manual interval, but never longer than 7 seconds.

It is possible to compute C_{STAT} and R_{STAT} with invalid data. For example, a leak can prevent the achievement of a plateau, or the lungs may not be empty when an inspiration begins. While the pause maneuver is in progress, software checks the quality of the data, and indicates when estimates for C_{STAT} and R_{STAT} are questionable.

The most recently selected graphics are displayed and frozen when an inspiratory pause maneuver begins, so you can assess the inspiratory pressure. P_{PL} is continuously updated and displayed during the inspiratory pause. C_{STAT} and R_{STAT} are displayed at the start of the next inspiratory phase. The value of R_{STAT} is computed and displayed only if the mandatory breath type is VC with square flow waveform.

4.11 How to interpret inspiratory pause maneuver results for static compliance and resistance

Compliance (C_{STAT}) is an estimate of the elasticity of the patient's lungs; it is expressed in mL/cmH₂O. Resistance (R_{STAT}) is the total inspiratory resistance across the artificial airway and respiratory system. It is an estimate of how restrictive the patient's airway is, based on the pressure drop at a given flow. It is expressed in cmH₂O/L/second. These values are computed during an operator-initiated inspiratory pause, in which the inspiratory valves and exhalation valve are closed. C_{STAT} is computed during a mandatory breath. R_{STAT} is computed during a VC mandatory breath with a square waveform.

During the pause, the most recently selected graphics are displayed and frozen, so you can see when inspiratory pressure stabilizes. C_{STAT} and R_{STAT} are displayed at the start of the next inspiration following the inspiratory pause. They take this format:

C_{STAT} xxx

or

R_{STAT} yyy

If the software determines variables in the equations or the resulting C_{STAT} or R_{STAT} values are out of bounds, it identifies the questionable C_{STAT} and R_{STAT} values with special formatting and text messages:

- Parentheses () signify questionable C_{STAT} or R_{STAT} values, derived from questionable variables.
- Flashing C_{STAT} or R_{STAT} values are out of bounds.
- Asterisks (*****) mean variables fall below noise-level bounds.
- R_{STAT} (-----) means resistance could not be computed, because the breath was not of a mandatory, VC type with square flow waveform.

Refer to Section 14.12 in the Technical Reference portion of this manual for detailed information on static compliance and resistance. Table 4-1 summarizes the significance and possible corrective actions for the C_{STAT} and R_{STAT} displays.

4.12 How to use NIV

When setting up or changing ventilation control parameters, you must select NIV (non-invasive ventilation) using the VENT TYPE button that appears on the *New Patient Setup* or *Current Setup* screens.

Choosing NIV allows ventilation with various non-invasive interfaces and with uncuffed endotracheal tubes in *NeoMode*.

4.12.1 NIV intended use

NIV is intended for use by neonatal, pediatric, and adult patients possessing adequate neural-ventilatory coupling and stable, sustainable, respiratory drive.

4.12.2 NIV breathing interfaces

Puritan Bennett has successfully tested the following non-vented interfaces with NIV:

Full-face Mask: Puritan Bennett® Benefit Full Face Mask (large, part number 4-005253-00), ResMed Mirage™ Non-Vented Full Face Mask (medium)

Nasal Mask: ResMed Ultra Mirage™ Non-vented Mask (medium)

Infant Nasal Prongs: Sherwood Davis & Geck Argyle® CPAP Nasal Cannula (small), Hudson RCI® Infant Nasal CPAP System (No. 3)

Uncuffed neonatal ET tube: Mallinckrodt Uncuffed Tracheal Tube, Murphy (3.0 mm)

Warning

- Use only non-vented patient interfaces with NIV.
 - Full-faced masks used for non-invasive ventilation should provide visibility of the patient's nose and mouth to reduce the risk of emesis aspiration.
 - Do not ventilate patients intubated with cuffed endotracheal or tracheostomy tubes using NIV Vent Type.
-

4.12.3 NIV setup

NIV can be initiated from either the *New Patient Setup* screen during Vent start-up or while the patient is being ventilated invasively. Figure 4-6 shows the New Patient Setup screen when NIV is the selected Vent Type.

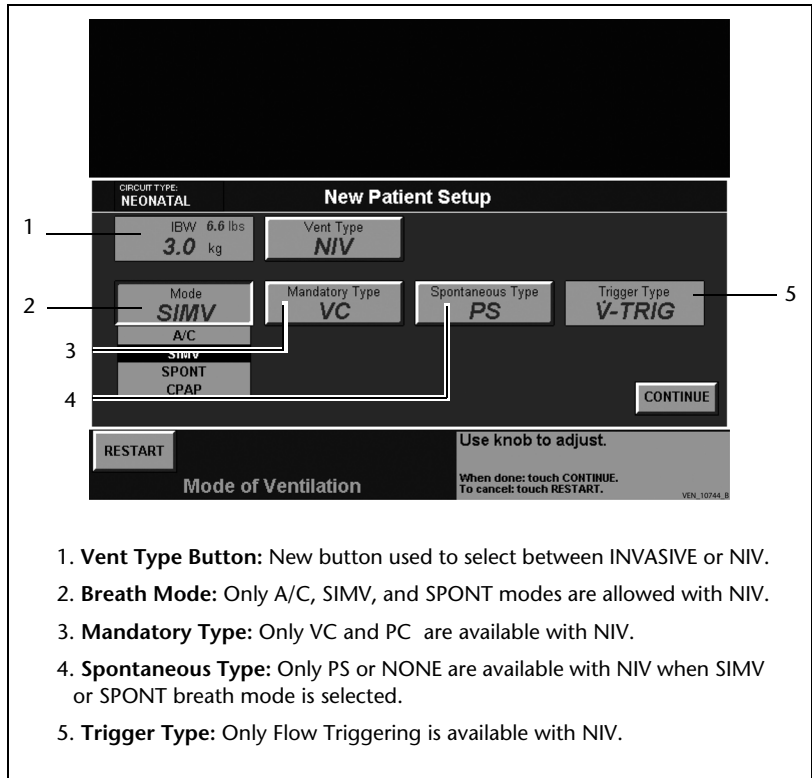

Figure 4-6. New patient setup screen — NIV

Refer to the sections “Changing patient from INVASIVE to NIV Vent Type” on page OP 4-36 and “Changing patient from NIV to INVASIVE Vent Type” on page OP 4-37 for information on automatic settings changes that occur when switching between Vent Types.

Follow these steps to set up the ventilator for NIV:

To set up a new patient:	To set up a patient currently being ventilated:
1. Turn the ventilator on.	1. Touch the VENT SETUP button. Proceed to step 3.
2. Select NEW PATIENT .	
3. Enter the patient's Ideal Body Weight (IBW).	
4. Touch the VENT TYPE button and turn the rotary knob to change to NIV.	
5. Touch the MODE button and turn the knob to select AC, SIMV, or SPONT. (BILEVEL mode is not available with NIV).	
6. Touch the MANDATORY TYPE button and turn the knob to choose pressure control (PC) or volume control (VC). (VC+ is not available with NIV.)	
7. If either SIMV or SPONT was selected in step 5, touch the SPONTANEOUS TYPE button and turn the knob to select PS or NONE. (TC, PA, and VS are not available with NIV.)	
<p>NOTE: With NIV selected as Vent Type, the only allowable trigger type is flow triggering (V -TRIG).</p>	

8. Press CONTINUE and adjust settings as needed. See Section 4.12.4, below, for information on the high spontaneous inspiratory time limit ventilator setting.

NOTE:

With NIV selected as Vent Type, the DISCONNECT SENSITIVITY (D_{SENS}) button appears on the *Settings* screen set to OFF. If desired, touch the button and turn the knob to set a value. To change the disconnect sensitivity after you have applied the ventilator settings, touch the OTHER SCREENS button, then the MORE SETTINGS button and make your changes.

Figure 4-7 shows the NIV settings screen.

9. Press ACCEPT to apply the settings. Review the apnea and alarm settings as described below.

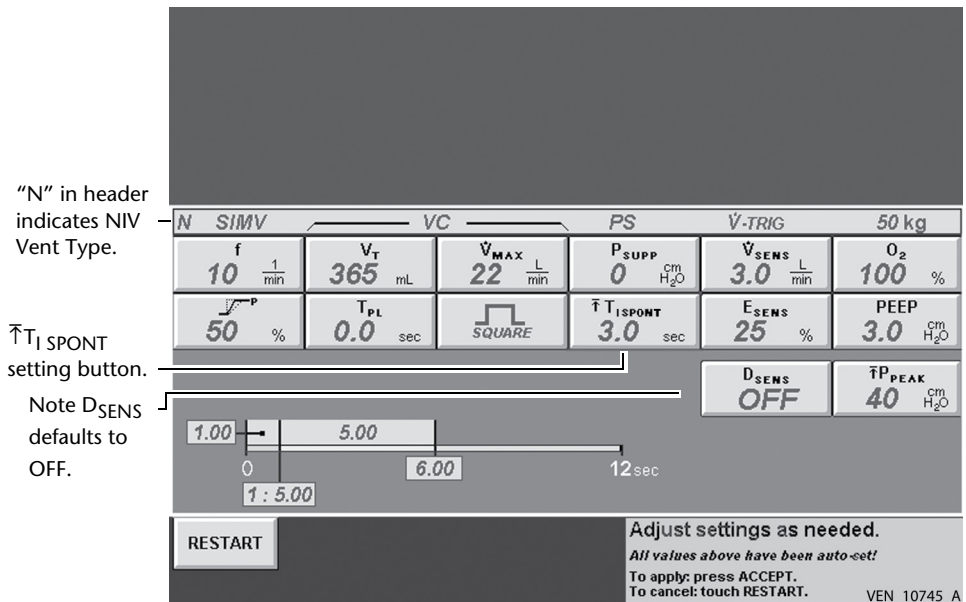

Figure 4-7. NIV ventilator settings screen

4.12.4 High spontaneous inspiratory time limit setting

NIV includes a setting in SIMV or SPONT modes for High Spontaneous Inspiratory Time limit ($\uparrow T_{I\text{ SPONT}}$). When a patient's inspiratory time reaches or exceeds the set limit, the ventilator transitions from inspiration to exhalation, and the $\uparrow T_{I\text{ SPONT}}$ symbol appears on the upper GUI screen, indicating the ventilator has truncated the breath (see Figure 4-9). The $\uparrow T_{I\text{ SPONT}}$ setting does not restrict changes to IBW; if the IBW is decreased, $\uparrow T_{I\text{ SPONT}}$ may be decreased automatically to remain within its allowable limits.

Warning

No audible alarm sounds in conjunction with the visual $\uparrow T_{I\text{ SPONT}}$ indicator, nor does the indicator appear in any alarm log or alarm message.

It is possible the target inspiratory pressure may not be reached if the $\uparrow T_{I\text{ SPONT}}$ setting is not long enough, or if system leaks are so large as to cause the ventilator to truncate the breath at the maximum allowable $\uparrow T_{I\text{ SPONT}}$ setting.

NOTE:

To reduce the potential for not reaching the target pressure, minimize the leaks in the system and increase the Rise time % and/or decrease the E_{SENS} setting, if appropriate.

4.12.5 Apnea setup

Set the patient's apnea parameters as described in Section 4.6. NIV does not change the way apnea parameters are set.

4.12.6 Alarm setup

Touch the ALARM SETUP button to display the current alarm settings and change the alarm settings as needed. A low circuit pressure ($\downarrow P_{PEAK}$) alarm is available during NIV to detect potential circuit disconnects or large system leaks based upon pressure measurements in the patient circuit. Refer to Table 5-1, Table A-14, and Table 13-2 for more information regarding the $\downarrow P_{PEAK}$ alarm. The $\downarrow P_{PEAK}$ alarm may be turned OFF, if desired. Figure 4-8 shows the NIV alarm screen with new patient default settings.

Yellow background with black letters on lower GUI screens indicates NIV Vent Type and current breath mode.

$\downarrow P_{PEAK}$ alarm limit

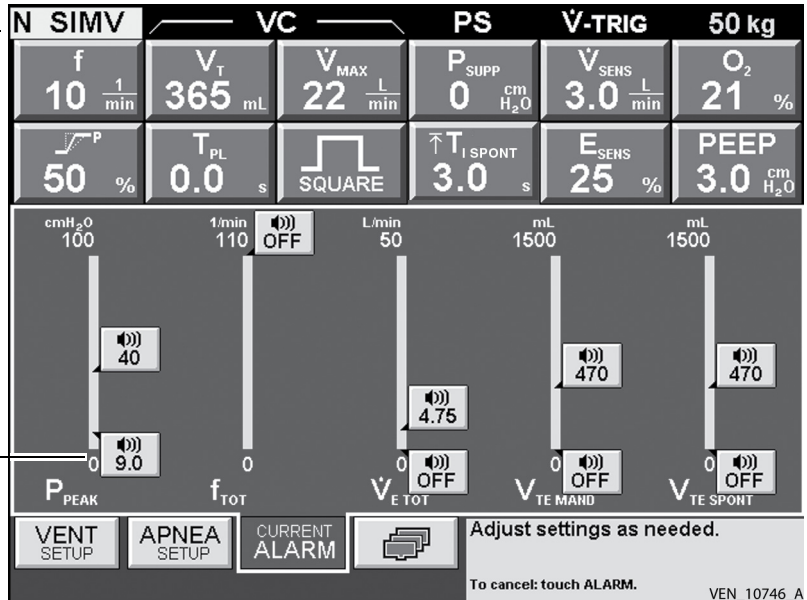

Figure 4-8. New patient default alarm settings

Warning

With NIV selected as the Vent Type, the new patient value for each of the following alarm limits is OFF:

$\uparrow f_{TOT}$ $\downarrow V_{E\ TOT}$ $\downarrow V_{TE\ MAND}$ $\downarrow V_{TE\ SPONT}$

Additionally, the $\downarrow P_{PEAK}$ alarm can be set to OFF.

Ensure you have set these alarms appropriately before connecting the patient to the ventilator.

4.12.7 Changing patient from INVASIVE to NIV Vent Type

Some ventilator settings available during INVASIVE ventilation are not available during NIV.

Table 4-4: Automatic settings changes — INVASIVE to NIV on same patient

Current INVASIVE setting	New NIV setting
Breath Mode: BILEVEL	Breath mode: A/C
Breath Mode: SIMV or SPONT	High $T_{I\ SPONT}$ ($\uparrow T_{I\ SPONT}$) limit setting available
Mandatory Type: VC+	Mandatory type: Adult/pediatric: VC Neonatal: PC
Spontaneous Type: Any type except NONE or PS	Spontaneous type: PS If Spontaneous Type set to NONE or PS during INVASIVE ventilation, NIV Spontaneous Type does not change.
<p>NOTE: In any delivered spontaneous breath, either INVASIVE or NIV, if Pressure Support is set to NONE or 0, there is always a target inspiratory pressure of 1.5 cmH₂O applied.</p>	

Table 4-4: Automatic settings changes — INVASIVE to NIV on same patient (cont)

Current INVASIVE setting	New NIV setting
Trigger type: Pressure	Trigger type: Flow (Flow triggering is the only allowable trigger type during NIV)
Alarm settings: $\downarrow P_{PEAK}$ (if applicable), $\downarrow \dot{V}_{E\ TOTAL}$, $\downarrow \dot{V}_{E\ MAND}$, $\downarrow \dot{V}_{E\ SPONT}$, INSPIRATION TOO LONG (not user-settable)	Alarm settings: $\downarrow P_{PEAK}$, $\downarrow \dot{V}_{E\ TOTAL}$, $\downarrow \dot{V}_{E\ MAND}$, $\downarrow \dot{V}_{E\ SPONT}$ default to NIV new patient values (see Table A-14). INSPIRATION TOO LONG alarm not available.
D_{SENS}	D_{SENS} setting defaults to OFF.

4.12.8 Changing patient from NIV to INVASIVE Vent Type

Table 4-5: Automatic settings changes — NIV to INVASIVE on same patient

Current NIV setting	New INVASIVE setting
Ventilator settings: $\uparrow T_{I\ SPONT}$	N/A
Alarm settings: $\downarrow P_{PEAK}$, $\downarrow \dot{V}_{E\ TOTAL}$, $\downarrow \dot{V}_{E\ MAND}$, $\downarrow \dot{V}_{E\ SPONT}$	Alarm settings: Default to new patient values dependent upon selected INVASIVE ventilator settings (see Table A-13). INSPIRATION TOO LONG alarm becomes available.
D_{SENS}	D_{SENS} setting defaults to INVASIVE new patient value (see Table A-13).

Warning

When changing the Vent Type on the same patient, review the automatic settings changes described in Tables 4-4 and 4-5 and adjust appropriately.

4.12.9 NIV patient data

Displayed patient data during NIV is different from data displayed during INVASIVE ventilation. During NIV, the upper GUI screen indicates that NIV is the selected Vent Type by displaying a yellow “NIV” indicator on the *More Patient Data* subscreen. Inspired tidal volume (V_{TI}) is displayed in the vital patient data area, and the monitored PEEP value is shown when you press the MORE PATIENT DATA button.

During NIV, V_{TI} appears in the *Vital patient data area* instead of PEEP.

NIV and $\uparrow T_{I\ SPONT}$ indicators on *More patient data* subscreen. Hidden if two or more alarms present.

PEEP moved to *More patient data* subscreen during NIV.

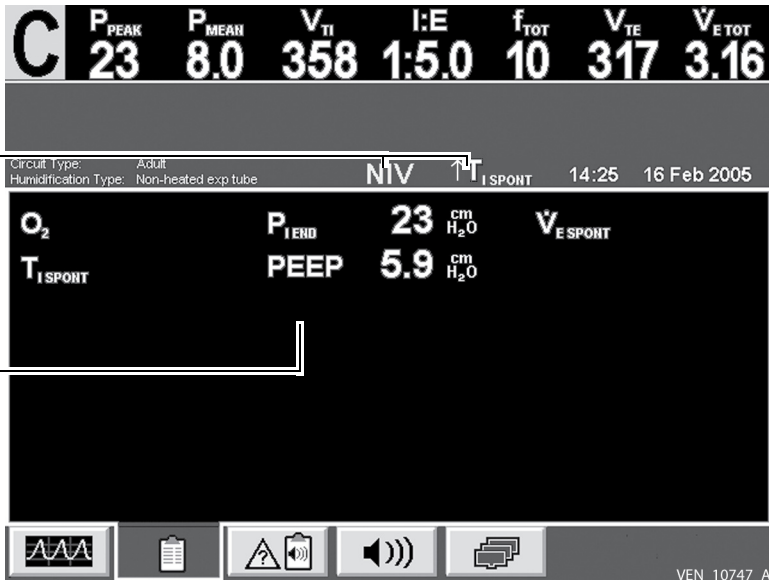

Figure 4-9. More patient data screen — NIV

How to handle alarms

Chapter 5 tells you:

- What the ventilator alarms are
- What to do if a ventilator alarm occurs
- What the ventilator alarm indicators are
- What the ventilator alarm classifications are

5.1 Ventilator alarm classifications

Alarms on the Puritan Bennett™ 840 Ventilator System are classified as high-, medium-, or low-urgency.

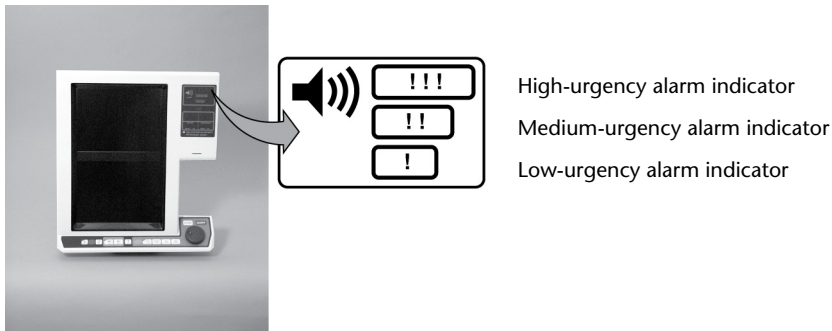

VEN_10748_A

Figure 5-1. Alarm indicators

- **!!!** *High-urgency alarms* require immediate attention to ensure patient safety. During a high-urgency alarm, the red high-urgency indicator flashes rapidly, the high-urgency audible alarm (a sequence of five tones that repeats twice, pauses, then repeats again) sounds, and the top of the upper screen flashes an alarm message. If a high-urgency alarm goes away spontaneously (autoresets), its indicator remains lit (not flashing) until you press the alarm reset key.

- !! • *Medium-urgency alarms* require prompt attention. During a medium-urgency alarm, the yellow medium-urgency indicator flashes slowly, the medium-urgency audible alarm (a repeating sequence of three tones) sounds, and the upper screen flashes an alarm message. If a medium-urgency alarm autoresets, the indicator turns off and the autoreset is entered in the alarm history log.
- ! • *Low-urgency alarms* tell you that there has been a change in the patient-ventilator system. During a low-urgency alarm, the yellow low-urgency indicator lights, the low-urgency audible alarm (two tone, non-repeating) sounds, and the upper screen displays an alarm message. If a low-urgency alarm autoresets, the indicator turns off and the autoreset is entered in the alarm history log.

NOTE:

You can change an alarm parameter even when alarms are active. You do not need to press the alarm reset key or wait for the alarm to autoreset. If the alarm had escalated to high urgency and you change its setting, the high urgency alarm indicator remains lit until the reset key is pressed.

5.2 Alarm silence

Warning

Never leave patient unattended when the alarm silence is active.



Press the alarm silence key to mute the alarm sound for two minutes. The key lights during the silence period, and turns off if the ALARM RESET key is pressed. An ALARM SILENCE IN PROGRESS indicator displays on the lower touch screen, along with a CANCEL button, if there is not a higher-priority alarm display active. To exit out of the alarm silence, touch the CANCEL button or press ALARM RESET.

The system automatically exits the alarm silence when the two-minute interval times out. A new high-urgency alarm (non-patient data related) (e.g. occlusion) cancels the alarm silence and the alarm sound turns on. Patient data alarms (e.g. INSPIRATION TOO LONG, $V_{TE\ MAND}$) and circuit disconnect alarms do not cancel an alarm silence.

Each time you press the alarm silence key, the silence period resets to two minutes. Each time you press the alarm silence key (whether or not there is an active alarm), the keypress is recorded in the alarm log. The ventilator makes another entry into the alarm log when the alarm silence ends (whether due to an elapsed alarm silence interval, the detection of a high-urgency alarm, or an alarm reset).

If no higher-priority screens are displayed on the lower screen (i.e., Vent setup, Apnea setup, Alarm setup, Other Screens or a new high urgency non-patient data related alarm), the Alarm Silence in Progress indicator appears (Figure 5-2).

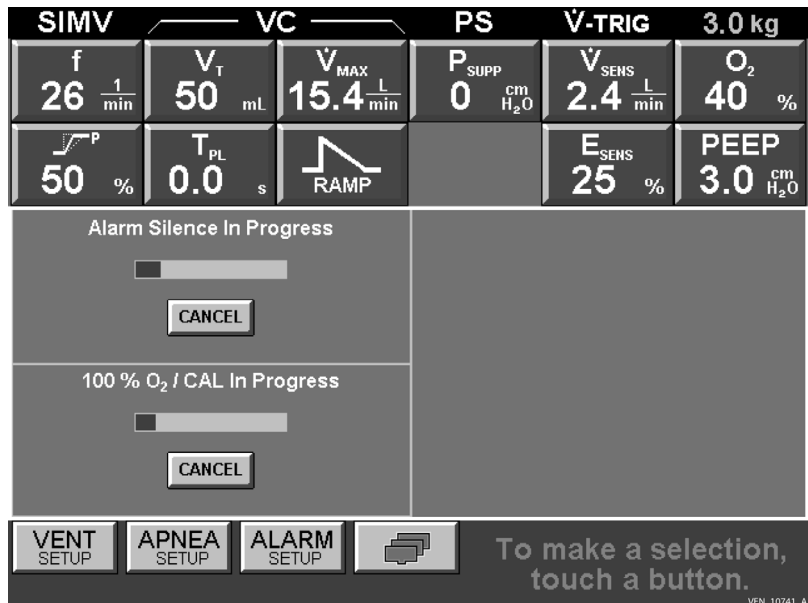

Figure 5-2. Alarm Silence in Progress indicator (lower screen)

5.3 Alarm reset



If you press the ALARM RESET key, the system resets the detection algorithms of all active alarms, except for these:

- AC POWER LOSS
- COMPRESSOR INOPERATIVE
- DEVICE ALERT
- INOPERATIVE BATTERY
- LOW AC POWER
- LOW BATTERY
- NO AIR SUPPLY
- NO O₂ SUPPLY
- O₂ SENSOR
- PROCEDURE ERROR
- SCREEN BLOCK

If you press the ALARM RESET key, there is no effect on the 100% O₂/CAL 2 min function, if it is active. The ventilator makes an entry into the alarm log when an active alarm is reset, and when an alarm silence is terminated by pressing the alarm reset key. No key press is recorded unless there is an active alarm.

If an alarm condition persists, the alarm becomes active again, according to the detection algorithm for that alarm. For example, if the APNEA alarm is active, the alarm reset key resets the apnea detection algorithm to its initial state and returns the ventilator to normal ventilation.

If you press the alarm reset key, the system cancels the alarm silence, if active (this avoids silencing an alarm condition that arises shortly after pressing the alarm reset key). If you press the alarm reset key, the system clears any high-urgency alarm that has autoreset (and the steadily lit high-urgency alarm indicator turns off).

The alarm reset key returns the ventilator to normal operation if an alarm condition has been resolved, without having to wait for alarm detection algorithms to reset the alarm. The ventilator

reannunciates any alarm condition that persists after pressing the alarm reset key.

5.4 Alarm log



To view the alarm log (Figure 5-3), touch the alarm log button on the upper screen. The alarm log shows alarm events (including time-stamped alarms, silences, and resets) in order of occurrence, with the most recent event at the top of the list.

Time	Event	Urgency	Alarm	Analysis
11:18:47 25 Jun 03	Manual Reset	Normal	APNEA	
11:16:53 25 Jun 03	End Alarm Silence	Normal	End Alarm Silence	
11:15:06 25 Jun 03	Autoreset	Normal	JV _{TE} MAND	
11:15:02 25 Jun 03	Augmented	LOW	JV _{TE} MAND	2 of last 4 mand breaths \leq set limit.
11:14:58 25 Jun 03	Augmented	MEDIUM	JV _{TE} MAND	3 of last 4 mand breaths \leq set limit.
11:14:52 25 Jun 03	Alarm Silence	Normal	Alarm Silence	

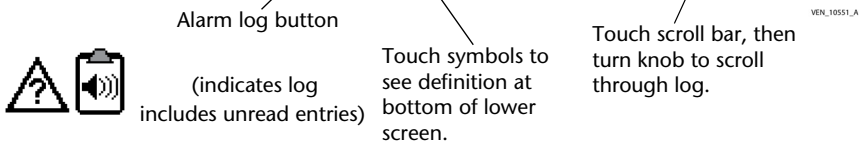

Figure 5-3. Alarm log



A question mark in a triangle appears on the ALARM LOG button if the log includes an event not yet viewed. To scroll through the alarm log, touch the scroll bar located at the right side of the alarm log, then turn the knob.

The ventilator makes a time-stamped entry into the alarm log whenever:

- an alarm is detected
- an alarm changes urgency level

- an alarm autoresets
- you press the alarm reset key when there is an active alarm
- you press the ALARM SILENCE key
- the alarm silence times out
- an alarm reset terminates the alarm silence
- a new high-urgency alarm terminates the alarm silence

The alarm log stores a maximum of the 80 most recent entries. When you complete a NEW PATIENT setup, the system erases the previous patient's alarm log.

5.5 Alarm volume



The off-screen alarm volume key adjusts the volume of all audible alarms, regardless of urgency level. To adjust alarm volume, press and hold the alarm volume key while turning the knob. The sound you hear when making an adjustment is equivalent in volume to the sound of an audible alarm, and is distinct from the sounds of low-, medium-, and high-urgency audible alarms. This sound continues as long as you hold down the key, and takes priority over active audible alarms.

The selected alarm volume remains unchanged after ventilator power is cycled. Because an alarm can require immediate clinical attention, you cannot turn alarm volume off.

Warning

The selectable alarm volume range is designed to ensure you can discern a ventilator alarm above background noise levels. Consider the existing noise levels and verify you have properly adjusted the alarm volume by pressing and holding the alarm volume key. If necessary, use the procedure described above to re-adjust the alarm volume.

Refer to Section A.4 for alarm volume specifications.

5.6 Alarm messages

The upper screen displays the two highest-urgency active alarms. An alarm icon flashes on the MORE ALARMS button if there are other active alarms. Touch the MORE ALARMS button to view a full screen of up to eight active alarms.

Each alarm message consists of a *base message*, an *analysis message* (supplementary information that includes any associated alarm conditions), and a *remedy message* that suggests corrective actions.

An alarm augmentation scheme is built into the Puritan Bennett 840 Ventilator System software to handle situations where the initial cause of an alarm has the potential to precipitate one or more related alarms. When an alarm occurs, any subsequent alarm related to the cause of this initial alarm “augments” the initial alarm instead of appearing on the upper GUI screen as a new alarm. The initial alarm’s displayed analysis message is updated with the related alarm’s information, and the Alarm Log Event column shows the initial alarm as “Augmented.”

Figure 5-4 shows how an alarm message is displayed on the upper screen. Table 5-1 lists possible alarm messages.

NOTE:

When more than one alarm is active and their alarm messages vary in their degree of seriousness, you should assume the most serious message is applicable.

The base message identifies the alarm. Touch alarm symbol to view definition on lower screen.

The analysis message gives the root cause of the alarm. May also include dependent alarms that have arisen due to the initial alarm.

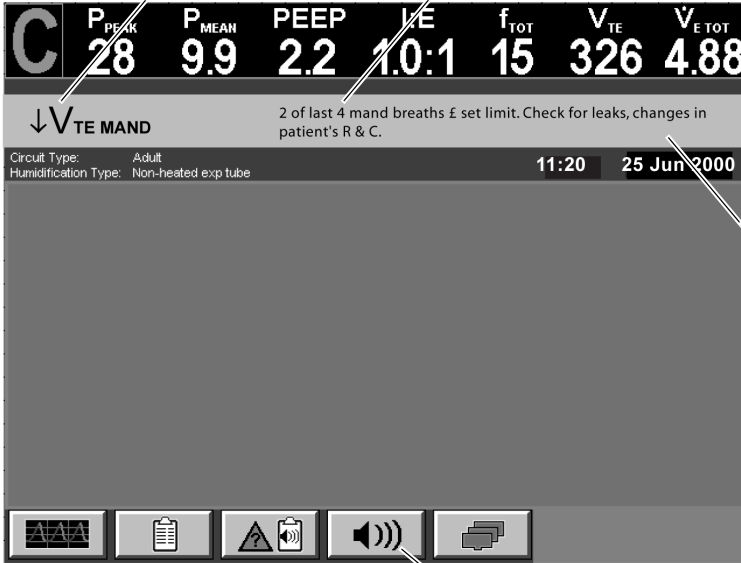

The two highest-priority active alarm messages are displayed here.

The remedy message suggests how to resolve the alarm condition.

Touch flashing more alarms button to view messages for up to six additional active alarms.

Figure 5-4. Alarm message format

Table 5-1: Alarm messages

When you see this message...	It means...	Do this...
AC POWER LOSS	The power switch is ON, AC power is not available, and the ventilator is being powered by the BPS.	<ul style="list-style-type: none"> • Prepare for power loss. • Obtain alternate ventilation source. • Check the integrity of AC power source. • Obtain service, if necessary.
APNEA	The set apnea interval has elapsed without the ventilator, patient, or operator triggering a breath. The ventilator has entered apnea ventilation.	<ul style="list-style-type: none"> • Check the patient. • Check the ventilator control parameters.
CIRCUIT DISCONNECT	There is a disconnection in the patient circuit. The ventilator switches to idle mode and displays the length of time without ventilator support.	<ul style="list-style-type: none"> • Check the patient. • Reconnect the patient circuit. • Press the alarm reset key.
COMPLIANCE LIMITED V_T	The compliance compensation limit has been reached. The inspired volume may be less than the control parameter value.	<ul style="list-style-type: none"> • Check the patient. • Verify the selected patient circuit type and the installed patient circuit match.
COMPRESSOR INOPERATIVE	The compressor is unable to maintain sufficient supply pressure, due to low AC power, AC power loss, or compressor malfunction.	<ul style="list-style-type: none"> • Check the patient. • Obtain alternative ventilation source. • If due to low or no power, alarm resets when full AC power is restored. • If due to compressor malfunction, remove ventilator from use and obtain service.

Table 5-1: Alarm messages (cont)

When you see this message...	It means...	Do this...
COMPRESSOR INOPERATIVE	The compressor is not connected properly to the BDU.	<ul style="list-style-type: none"> • Check the patient. • Reconnect the compressor air hose, compressor power cable, and compressor data cable.
DEVICE ALERT	The POST or a background test has detected a problem.	<ul style="list-style-type: none"> • Check the patient. • If prompted to do so, obtain alternate ventilation and obtain service.
$\uparrow P_{PEAK}$ (High circuit pressure)	The measured airway pressure is equal to or greater than the set limit. Reduced tidal volume likely.	<ul style="list-style-type: none"> • Check the patient. • Check the patient circuit. • Check the endotracheal tube.
$\uparrow O_2\%$ (High delivered $O_2\%$)	<p>The $O_2\%$ measured during any phase of a breath cycle is 7% (12% during the first hour of operation) or more above the set $O_2\%$ parameter for at least 30 seconds.</p> <p>When you decrease the set $O_2\%$ parameter, the percentages increase by 5% for the next four minutes of ventilation.</p>	<ul style="list-style-type: none"> • Check the patient, the air and oxygen supplies, the oxygen analyzer, and the ventilator.
$\uparrow V_{TE}$ (High exhaled tidal volume)	The patient's exhaled tidal volume for any breath is equal to or greater than the set limit.	<ul style="list-style-type: none"> • Check the patient and the ventilator control parameters. • Check for changes in patient compliance or resistance.
$\uparrow \dot{V}_{E\text{ TOT}}$ (High exhaled total minute volume)	The patient's expiratory minute volume is equal to or greater than the set limit.	<ul style="list-style-type: none"> • Check the patient and the ventilator control parameters.

Table 5-1: Alarm messages (cont)

When you see this message...	It means...	Do this...
$\uparrow f_{TOT}$ (High respiratory rate)	The breath rate from all breaths is greater than or equal to the set limit.	<ul style="list-style-type: none"> • Check the patient and the ventilator control parameters.
$\uparrow P_{VENT}$ (High internal ventilator pressure)	The inspiratory pressure transducer has measured a pressure of at least 100 cmH ₂ O. The ventilator transitions to exhalation. A reduced tidal volume is likely.	<ul style="list-style-type: none"> • Check the patient, the patient circuit (including filters), and the endotracheal tube. Ensure the ET tube ID is the correct size. Check the ventilator flow and/or volume settings. • Re-run SST. • Obtain alternate ventilation source. • Remove the ventilator from clinical use and obtain service.
INOPERATIVE BATTERY	The BPS is installed but is not functioning.	<ul style="list-style-type: none"> • Remove the ventilator from clinical use and obtain service.
INSPIRATION TOO LONG	The IBW-based inspiratory time for a spontaneous breath exceeds the ventilator-set limit. Active only when Vent Type is INVASIVE.	<ul style="list-style-type: none"> • Check the patient. • Check the patient circuit for leaks. • Check Rise time and E_{SENS} settings.
LOSS OF POWER	The ventilator power switch is on, but there is insufficient power from the mains AC and the BPS. There may not be a visual indicator for this alarm, but an independent audio alarm sounds for at least 120 seconds.	<ul style="list-style-type: none"> • Check the integrity of the AC power and BPS connections. • Obtain alternative ventilation if necessary. • Turn the power switch off to reset alarm.

Table 5-1: Alarm messages (cont)

When you see this message...	It means...	Do this...
<p>LOW AC POWER</p>	<p>The mains AC power dropped below 80% of the nominal voltage for at least one second. The error message signals the AC power has dropped significantly, and a more severe power drop may be imminent. The ventilator turns off the compressor (if installed), but otherwise operates normally.</p>	<ul style="list-style-type: none"> • Prepare for possible loss of power. • Check the integrity of the AC power connection. • Check the AC power supply.
<p>LOW BATTERY</p>	<p>The BPS is installed, but it has less than two minutes of operational time remaining.</p>	<ul style="list-style-type: none"> • Replace the BPS or allow it to recharge during normal ventilator operation.
<p>↓O₂% (Low delivered O₂%)</p>	<p>The O₂% measured during any phase of a breath cycle is 7% (12% during the first hour of operation) or more below the O₂% parameter for at least 30 seconds. The percentage increases by 5% for four minutes after you increase the set O₂% value.</p>	<ul style="list-style-type: none"> • Check the patient, the air and oxygen supplies, the oxygen analyzer, and the ventilator. • Calibrate oxygen sensor (press 100% O₂/CAL 2 min key or INCREASE O₂ 2 min key). See page TR 15-6 for more information on calibrating the oxygen sensor. • Use an external O₂ monitor and disable the O₂ sensor.

Table 5-1: Alarm messages (cont)

When you see this message...	It means...	Do this...
$\downarrow P_{PEAK}$ (Low circuit pressure)	<p>The peak inspiratory pressure in the patient circuit has dropped below the set alarm limit.</p> <p>This alarm is only available when NIV is the selected Vent Type or when VC+ is the selected Mandatory type during INVASIVE ventilation.</p> <hr/> <p>Warning</p> <p>Because the VC+ pressure control algorithm does not allow the target inspiratory pressure to fall below PEEP + 5 cmH₂O, attempting to set the $\downarrow P_{PEAK}$ alarm limit at or below this level will turn the alarm off.</p> <hr/>	<ul style="list-style-type: none"> • Check the breathing system for leaks.
$\downarrow V_{TE MAND}$ (Low exhaled mandatory tidal volume)	<p>The patient's exhaled mandatory tidal volume is less than or equal to the set limit.</p>	<ul style="list-style-type: none"> • Check the patient. • Check for leaks in the patient circuit. • Check for changes in the patient resistance or compliance.
$\downarrow V_{TE SPONT}$ (Low exhaled spontaneous tidal volume)	<p>The patient's exhaled spontaneous tidal volume is less than or equal to the set limit.</p>	<ul style="list-style-type: none"> • Check the patient. • Check the ventilator control parameters.

Table 5-1: Alarm messages (cont)

When you see this message...	It means...	Do this...
$\downarrow V_{E\text{ TOT}}$ (Low exhaled total minute volume)	The minute volume for all breaths is less than or equal to the set limit.	<ul style="list-style-type: none"> • Check the patient. • Check the ventilator control parameters.
NO AIR SUPPLY	The air supply pressure is less than the minimum pressure required for correct ventilator operation. The ventilator delivers 100% O ₂ if available. O ₂ % delivery may be compromised. If an oxygen supply is not available, the safety valve opens. The ventilator displays the elapsed time without ventilator support. This alarm cannot be set or disabled.	<ul style="list-style-type: none"> • Check patient. • Check the air and oxygen sources. • Obtain alternative ventilation if necessary.
NO O ₂ SUPPLY	The oxygen supply pressure is less than the minimum pressure required for correct ventilator operation. The ventilator delivers 100% air if available. O ₂ % delivery may be compromised. If an air supply is not available, the safety valve opens. The ventilator displays the elapsed time without ventilatory support. This alarm cannot be set or disabled.	<ul style="list-style-type: none"> • Check the patient. • Check the oxygen and air sources. • Obtain alternative ventilation if necessary.

Table 5-1: Alarm messages (cont)

When you see this message...	It means...	Do this...
O ₂ SENSOR	Background checks have detected a problem with the oxygen sensor (sensor failure or it is out of calibration). Patient ventilation is unaffected.	<ul style="list-style-type: none"> • Press 100% O₂ CAL 2 min or INCREASE O₂ 2 min key to recalibrate the oxygen sensor. See page TR 15-6 for more information on calibrating the oxygen sensor. • Disable the oxygen sensor • Replace the oxygen sensor.
PROCEDURE ERROR	The patient is attached before ventilator startup is complete. Safety ventilation is active.	<ul style="list-style-type: none"> • Provide alternate ventilation if necessary. • Complete ventilator startup procedure.
SCREEN BLOCK	A possible blocked beam or touch screen fault.	<ul style="list-style-type: none"> • Remove obstruction from the touch screen or obtain service.
SEVERE OCCLUSION	The patient circuit is severely occluded. The ventilator enters occlusion status cycling. The elapsed time without ventilatory support is displayed. If the <i>NeoMode</i> is in use, the ventilator delivers 40% O ₂ if available.	<ul style="list-style-type: none"> • Check the patient. • Obtain alternative ventilation. • Check patient circuit for bulk liquid, crimps, blocked filter. • If problem persists, remove ventilator from use and obtain service.

This page is intentionally blank.

How to view graphics

Chapter 6 tells you:

- How to set up graphic displays of patient data.
- How to freeze a graphic display of patient data.
- How to adjust the vertical and horizontal scales of a graphic display.

6.1 Graphics display function

The graphics function displays real-time patient data. Five patient data formats are available:

- Pressure-time curve
- Flow-time curve
- Volume-time curve
- Pressure-volume loop
- Flow-volume loop

Figure 6-1 shows an example of a pressure-volume loop.

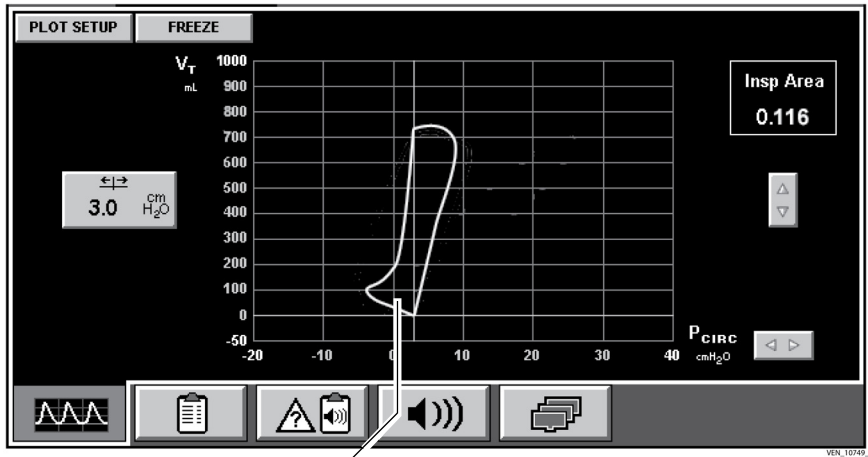

Figure 6-1. Pressure-volume loop

The flow-volume loop can be used with or without the *Respiratory Mechanics (RM)* software option (Figure 6-2).

Scaling is selectable by the user, from -2000 to 6000 mL for volume (x-axis), and up to 200 L/min for flow (y-axis). The plot begins at the start of inspiration with the inspiratory flow curve plotted above the x-axis, and the expiratory flow curve plotted below the x-axis.

NOTE:

Traditionally, Flow-Volume loops are presented with inspired flow plotted below the horizontal axis, and exhaled flow plotted above, with the plot beginning at the start of exhalation.

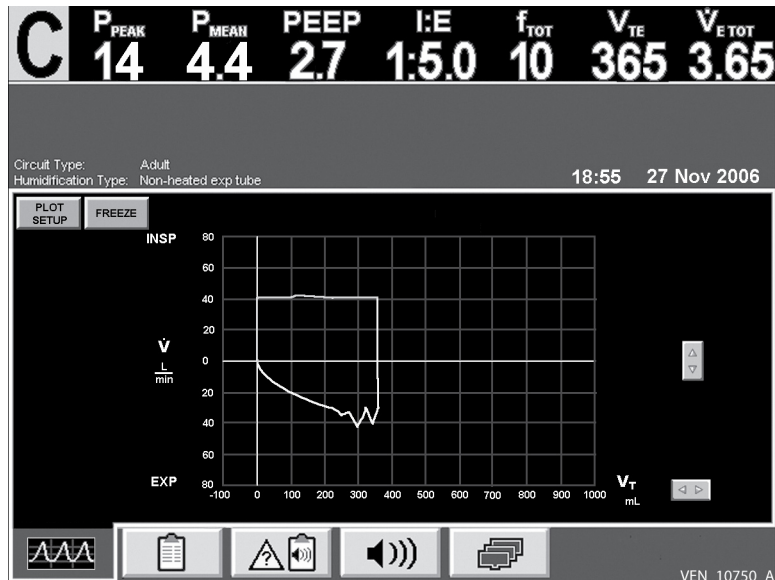
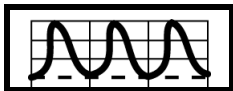

Figure 6-2. Flow-volume loop

6.2 How to set up a graphics display

You can choose to display one or two time curves in a single graph. However, if you choose the pressure-volume loop, it uses the entire screen when it is displayed, so you cannot select a second waveform for display in this instance.



- 1 Touch the GRAPHICS button at the lower left of the upper screen. Graphics appear.



- 2 Touch PLOT SETUP at the upper left of the screen.

Shadow Trace
Enabled

- 3 If TC or PA is selected as Spontaneous Type, touch the Shadow Trace button and turn the knob to disable or enable the Shadow Trace feature.

Plot 1
Pressure-Time

- 4 Touch PLOT 1: A drop-down menu of available selections appears with the current selection highlighted. Turn the knob to select the graphics display function.

If you select pressure-volume, which uses the entire screen, the PLOT 2 button disappears.

Plot 2
Flow-Time

- 5 Touch PLOT 2, if applicable. Turn the knob to highlight the selection from the drop-down menu.

If you select NONE, only one enlarged plot (with higher resolution) appears.

CONTINUE

- 6 Touch CONTINUE to display the graphics you have selected. You do not need to touch ACCEPT.

6.3 Graphics display details and calculations

- If you select the pressure-volume loop, the loop for the next full breath is displayed, then the graphics display is updated every other breath.
- The pressure-time curve shows an estimate of carinal pressure (P_{CARI}) as a shaded area within the waveform when the TC option is active and shadow trace is enabled.
- The pressure-time curve shows an estimate of lung pressure (P_{LUNG}) as a shaded area within the waveform when the PA option is active and shadow trace is enabled.

NOTE:

The graphic displays of carinal and lung pressures are estimates, *not* actual measurements.

- The inspiratory area is calculated based on the area inside the loop to the left of the baseline.
- Curves (pressure-time, flow-time, and volume-time) are drawn on the screen at the start of a breath, beginning with the last ½ second of the previous breath.

6.4 How to adjust displayed graphics



- To move the baseline on a pressure-volume loop, touch the baseline pressure button, then use the knob to position the baseline.

The default position of the baseline is the positive end-expiratory pressure (PEEP) parameter. If the PEEP parameter changes, the baseline resets to PEEP.

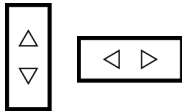

- To adjust vertical and horizontal scales, touch the arrow buttons, then turn the knob to select. You do not need to touch ACCEPT.

6.5 The graphics display FREEZE function

Follow these steps to freeze graphics on the screen so you can view them for an extended period of time.

FREEZE

- 1 Touch FREEZE. The screen flashes the message *FREEZING*, the UNFREEZE button appears, and the scaling buttons disappear. Plotting continues until the screen is full.

NOTE:

The screen freezes automatically when INSP PAUSE and EXP PAUSE maneuvers are performed.

- 2 After the screen is filled with data and frozen, the other on-screen scaling buttons reappear. You can now redo the plot setup and adjust the scales for the last 48 seconds of frozen data. The pressure-volume display shows only the most recent full breath within the 48-second freeze period.

Graphics remain frozen even if you switch to another screen (for example, MORE ALARMS) and then return to the graphics screen.

UNFREEZE

- 3 Touch the UNFREEZE button at any time to view current graphics.

6.6 How to print patient data graphics

When graphics are frozen, the PRINT button appears in the upper left corner of the screen. Follow these steps to print frozen graphics on the screen:



- 1 Touch the PRINT button. The flashing message *PRINTING* replaces the PLOT SETUP, UNFREEZE, and PRINT buttons. You may stop printing by touching the CANCEL button.
- 2 After all of the graphics data has been sent to the printer, the PLOT SETUP, UNFREEZE, and PRINT buttons reappear.

NOTE:

To print graphics, you must have a printer attached to RS-232 serial port 1, the RS-232 serial port must be configured with *PRINTER* as the selected device, and the printer and 840 ventilator communications settings must match. Refer to Section E.3 for instructions on how to configure the RS-232 port, and Section E.4 for information on cables and printers.

6.7 Automatic display of graphics

Whenever you press the EXP PAUSE or the INSP PAUSE key, the most recently selected graphics are displayed and frozen. You can then observe when expiratory or inspiratory pressure stabilizes.

6.8 When graphics are not accessible

When certain conditions exist, the graphics display is not accessible:

- If the ventilator goes into apnea ventilation or safety ventilation, patient data graphics are not displayed. However, you can touch the GRAPHICS button to redisplay graphics.
- If you touch the MORE PATIENT DATA, ALARM LOG, MORE ALARMS, or OTHER SCREENS button, any currently displayed graphics disappear.

If you touch the graphics button while graphics are already displayed, the graphics screen disappears. Unless the screen has been frozen, the waveform plots will be erased.

Preventive maintenance

Chapter 7 tells you:

- How to clean, disinfect, and sterilize the Puritan Bennett™ 840 Ventilator System components and accessories.
- How to perform routine preventive maintenance procedures.
- How to store the ventilator for an extended period of time.
- How to repack and ship the ventilator.

To ensure proper ventilator operation, perform the maintenance procedures at the recommended intervals. You should adapt all procedures given in Chapter 7 to your institution's policies and protocol.

Puritan Bennett recommends only qualified personnel perform additional maintenance procedures. Contact Puritan Bennett technical support or your local representative for additional information.

7.1 How to dispose of used parts

Discard all parts removed from the ventilator during the maintenance procedures in accordance with your institution's protocol. Sterilize parts before nondestructive disposal. Follow local governing ordinances and recycling plans regarding disposal or recycling of device components.

7.2 How to clean, disinfect and sterilize parts

Table 7-1 describes how to clean, disinfect, and sterilize ventilator components.

Warning

- Do not attempt to remove, clean, or flush the flow sensor with liquids or pressurized air.
 - To avoid patient exposure to sterilizing agents, be sure to sterilize parts in accordance with the techniques described in Table 7-1. Exposure to sterilizing agents may reduce the useful life of some parts.
 - Handle filters with care, to minimize the risk of bacterial contamination or physical damage.
 - Always follow your institution's infection control guidelines.
-

NOTE:

Puritan Bennett recognizes sanitation practices vary widely among health care institutions. It is not possible for Puritan Bennett to either specify or require specific practices to meet all needs. Puritan Bennett is not responsible for the effectiveness of procedures used to clean, disinfect, and sterilize parts, or other practices carried out in the patient care environment. This manual can only provide general guidelines to clean, sterilize, and disinfect parts. It is the user's responsibility to ensure the validity and effectiveness of the methods used.

Table 7-1: Procedures to clean, disinfect, and sterilize parts

Part	Procedure	Comments
Ventilator exterior (including touch screen and flex arm)	<p>Wipe clean with a damp cloth and mild soap solution or with one of the chemicals listed below or its equivalent. Use a damp cloth and water to rinse off chemical residue as necessary.</p> <ul style="list-style-type: none"> • Mild dishwashing detergent • Isopropyl alcohol (70% solution) • Bleach (10% solution) • Window cleaning solution (with isopropyl alcohol and ammonia) • Ammonia (15% solution) • Hydrogen peroxide (3% solution) • Formula 409® cleaner (Clorox Company) • Amphyl® disinfectant (National Laboratories, Reckitt & Colman Inc.) • Cavicide® surface disinfectant (Metrex Research Corporation) • Control III® germicide (Meril Products Inc.) • Glutaraldehyde (3.4% solution) <p>Vacuum the vents at the back of the graphic user interface (GUI) to remove dust.</p>	<ul style="list-style-type: none"> • Do not allow liquid or sprays to penetrate the ventilator or cable connections. • Do not attempt to sterilize the ventilator by exposure to ethylene oxide (ETO) gas. • Do not use pressurized air to clean or dry the ventilator, including the GUI vents.
<div style="background-color: black; color: white; padding: 5px;">Caution</div> <ul style="list-style-type: none"> • <i>To avoid damaging filter materials used on the back of the GUI, do not use hydrogen peroxide to clean the GUI. (This is applicable to the 9.4-inch GUI, which is an earlier version of the GUI.)</i> • <i>To prevent damage to ventilator labeling and ventilator surfaces in general, use only the listed chemicals to clean the ventilator exterior.</i> 		

Table 7-1: Procedures to clean, disinfect, and sterilize parts (cont)

Part	Procedure	Comments
Patient circuit tubing	Disassemble and clean, then autoclave, pasteurize, or chemically disinfect. Single-patient use patient circuits: Discard.	<ul style="list-style-type: none"> • If you submerge the patient circuit in liquid, use pressurized air to blow the moisture from inside the tubing before use. • Inspect for nicks and cuts, and replace if damaged. • Run SST to check for leaks when a new circuit is installed.
	<div style="background-color: black; color: white; padding: 2px;">Caution</div> <p><i>Steam sterilization is a viable sterilization method for 840 ventilator patient circuits supplied by Puritan Bennett , but it may shorten the tubing’s life span. Discoloration (yellowing) and decreased tubing flexibility are expected side effects of steam sterilizing this tubing. These effects are cumulative and irreversible.</i></p>	
In-line water traps	Disassemble and clean, then autoclave, pasteurize, or chemically disinfect.	Inspect water traps for cracks. Replace traps if damaged.
Couplings and connectors	Autoclave, pasteurize, or chemically disinfect.	<ul style="list-style-type: none"> • If you submerge the couplings and connectors in liquid, use pressurized air to blow moisture from the inside of the components before use. • Inspect components for nicks and cuts. Replace if damaged.
Expiratory collector vial	Reusable expiratory filter assembly: Clean, then autoclave or chemically disinfect the collector vial. Single-patient use expiratory filter assembly: Discard.	Inspect the collector vial for cracks. Replace collector vial if damaged.

Table 7-1: Procedures to clean, disinfect, and sterilize parts (cont)

Part	Procedure	Comments
Expiratory and inspiratory bacteria filters	Reusable filters: Autoclave. Single-patient use: Discard. Before discarding, disinfect or sterilize according to your institution's protocol.	<ul style="list-style-type: none"> • Effective sterilization of Puritan Bennett inspiratory and expiratory filters occurs by steam autoclaving at 132 °C (270 °F) for 20 minutes for gravity displacement cycles. • Do not chemically disinfect or expose to ETO gas. • Check filter resistance before reuse. • Follow manufacturer's recommendations for reusability.
Compressor inlet filter	Clean every 250 hours or as necessary: wash in mild soap solution, rinse, and air-dry.	Replace filter element if torn or damaged.
Drain bag, tubing, and clamp	Discard the drain bag when filled to capacity or when you change the patient circuit. Clean and autoclave the reusable tubing. Wipe the reusable clamp with alcohol or pasteurize.	<ul style="list-style-type: none"> • Do not autoclave clamp. • Replace clamp if visibly damaged.
Air inlet filter bowl	Wash the bowl exterior with mild soap solution if needed.	<ul style="list-style-type: none"> • Avoid exposure of the air inlet filter bowl to aromatic solvents, especially ketones. • Replace if cracks or crazing are visible.
Other accessories	Follow manufacturer's instructions.	

7.2.1 How to clean components

Do not clean or reuse single-patient use or disposable components. When cleaning reusable components, do not use hard brushes or other implements that could damage surfaces.

- 1 Wash the parts in warm water and mild soap solution.
- 2 Rinse the parts thoroughly in clean, warm water (tap water is acceptable) and wipe dry.
- 3 After you clean the components, inspect them for damage, such as cracks and crazing. Replace any damaged components.

Whenever you replace or reinstall parts on the ventilator, always run short self test (SST) before you begin to ventilate a patient.

Caution

Follow the soap manufacturer's instructions. Product exposure to soap solution more highly concentrated than necessary can shorten the useful life of the product. Soap residue can cause blemishes or fine cracks, especially on parts exposed to elevated temperatures during sterilization.

7.3 Disinfection and sterilization

Do not disinfect, sterilize, or reuse single-patient use or disposable components.

When you sterilize reusable tubing, coil the tubing in a large loop. Avoid kinks and do not cross the tubing. The tubing lumen should be free of any visible droplets before you wrap it in muslin or equivalent paper, in preparation for the autoclave.

Table 7-2 summarizes disinfection and sterilization procedures.

Caution

Formaldehyde and phenol-based disinfectants are not recommended because they can cause plastic parts to crack and craze.

Table 7-2: Disinfection and sterilization procedures

Autoclave sterilization	Pasteurization	Chemical disinfection
<p>Effective sterilization occurs by steam autoclaving at 132 °C (270 °F) for 20 minutes for gravity displacement cycles. Follow the steam sterilizer manufacturer's instructions.</p>	<p>Place the parts in a heat pasteurizer at 76 to 79 °C (169 to 174 °F) for 30 minutes.</p>	<p>Immerse the parts in disinfectant, and follow the manufacturer's instructions.</p> <p>Acceptable disinfectants include the following or their equivalents:</p> <ul style="list-style-type: none"> • ammonia (15% solution) • Amphyl® • bleach (10% solution) • CaviCide® • Cidex™, Control III® • isopropyl alcohol (70% solution) <hr/> <p>NOTE:</p> <p>The exposure of the parts to more concentrated disinfectant for excessive time may shorten the life of the product.</p> <hr/>
<p>1 Disassemble the component.</p> <p>2 Clean the component parts. (See Section 7.2.1 for details.)</p>	<p>1 Disassemble the component.</p> <p>2 Clean the component parts. (See Section 7.2.1 for details.)</p>	<p>1 Disassemble the component.</p> <p>2 Clean the component parts. (See Section 7.2.1 for details.)</p>

Table 7-2: Disinfection and sterilization procedures (cont)

Autoclave sterilization	Pasteurization	Chemical disinfection
<p>3 Wrap each component part in muslin or equivalent paper for autoclaving.</p>	<p>3 Place parts in the heat pasteurizer and pasteurize.</p>	<p>3 Place parts in the cleaning solution to disinfect.</p>
<p>4 Place the wrapped parts in the steam autoclave and sterilize.</p>	<p>4 Inspect the pasteurized parts for damage. Discard the component if you detect damage.</p>	<p>4 Inspect the disinfected parts for damage. Discard the component if you detect damage.</p>
<p>5 Inspect the sterilized parts for damage. Discard the component if you detect damage.</p>	<p>5 Reassemble the component.</p>	<p>5 Reassemble the component.</p>
<p>6 Reassemble the component.</p>	<p>6 Install the component on the ventilator.</p>	<p>6 Install the component on the ventilator.</p>
<p>7 Install the component on the ventilator.</p>	<p>7 Run SST.</p>	<p>7 Run SST.</p>
<p>8 Run SST.</p>		
<p>NOTE: To prevent the occurrence of spots and blemishes on parts exposed to elevated temperatures, thoroughly rinse and dry parts prior to autoclave sterilization or pasteurization.</p>		

7.4 Preventive maintenance procedures for the operator

Table 7-3 summarizes preventive maintenance procedures and the frequency Puritan Bennett recommends. The operator should routinely perform these preventative maintenance procedures at the recommended intervals. Instructions for the preventative maintenance procedures follow Table 7-3.

7.4.1 Total operational hours

Determine the total number of operational hours of the ventilator and the compressor as follows:

- 1 Press OTHER SCREENS on the touch screen of the ventilator.
- 2 Press OPERATIONAL TIME LOG to obtain operational hours.

Caution

To avoid component damage due to excessive wear, perform preventive maintenance and replace components at recommended intervals. You may find it convenient to note anticipated replacement dates for all components based on typical use rates or recommended intervals.

Table 7-3: Operator preventive maintenance procedures and frequency

Frequency	Part	Maintenance
Several times a day or as required by your institution's policy	Patient circuit: inspiratory and expiratory limbs	<ul style="list-style-type: none"> • Check both limbs for water build-up • Empty and clean each limb as necessary
	Inspiratory and expiratory bacteria filters	<ul style="list-style-type: none"> • Inspect the filters for damage and replace if necessary. If you replace a filter, rerun SST before you return the ventilator to clinical use. • Check the resistance across inspiratory and expiratory filters as follows: <ul style="list-style-type: none"> – before every use – after 15 days of continuous use in the exhalation limb – whenever you suspect excess resistance Run an SST to check the resistance of the expiratory filter.
	Collector vial, water traps, and drain bag	Check and empty as needed.

Table 7-3: Operator preventive maintenance procedures and frequency (cont)

Frequency	Part	Maintenance
Daily or as necessary	Oxygen sensor	Press the 100% O ₂ /CAL 2 MIN key or INCREASE O ₂ 2 min key to calibrate the oxygen sensor. See page TR 15-6 for more information on calibrating the oxygen sensor. Refer to Appendix D in this manual to test the oxygen sensor calibration.
	Air inlet filter bowl	<ul style="list-style-type: none"> • Replace the bowl if it is cracked. • If any sign of moisture is visible, remove ventilator from use and contact service or maintenance.
Every 250 hours (or more often, if required)	Compressor inlet filter	Clean.

Table 7-3: Operator preventive maintenance procedures and frequency (cont)

Frequency	Part	Maintenance
Every year or as needed	Reusable expiratory bacteria filters	Inspect and replace if you see cracks or crazing. Sterilize between patients and circuit changes, or according to your institution's policy. Sterilize before nondestructive disposal.
	Oxygen sensor	<ul style="list-style-type: none"> • Replace the oxygen sensor as needed. • Actual sensor life depends on operating environment. Operation at higher temperature or O₂% levels will result in shorter sensor life. Refer to Appendix D for the oxygen sensor replacement procedure.
Every year maximum or as needed	Reusable inspiratory bacteria filters	<ul style="list-style-type: none"> • Replace the filter. • Sterilize between patients and circuit changes, or according to your institution's policy. • Sterilize before nondestructive disposal.

7.4.2 Inspiratory and expiratory bacteria filters

Warning

The use of nebulized medication can cause a build-up of exhalation flow resistance and may even block the expiratory filter. Inspect and test expiratory filters at patient setup and frequently while in use.

- Inspect the inspiratory and expiratory filters before every use, and after 15 days of continuous use in the exhalation limb.

- Run SST to check the resistance across the inspiratory and expiratory filters before every use and after 15 days of continuous use in the exhalation limb.
- At every patient circuit change, autoclave reusable filters or discard and replace single-patient use filters.
- Replace reusable inspiratory filters after one year of service (maximum). Check filter resistance after each autoclave. Discard filter if it exceeds recommended filter resistance.
- Replace reusable expiratory filters after a maximum of one year of service. When you put a new filter into service, write the anticipated replacement date on the filter.

Acceptable resistance for inspiratory filters:

- Filter resistance of 4 cmH₂O (4 hPa) or less at 60 L/min flow or 0.5 cmH₂O (0.5 hPa) or less at 30 L/min flow can indicate a ruptured filter. Discard the filter.
- Filter resistance greater than 4 cmH₂O at 100 L/min flow or greater than 2 cmH₂O (2 hPa) at 30 L/min flow can indicate an occluded filter.

For reusable filters, autoclave and check the resistance again.
For single-patient use filters, discard and replace with a new filter.

Acceptable resistance for expiratory filters:

- Filter resistance of 0.6 cmH₂O (0.6 hPa) or less at 60 L/min flow or 0.3 cmH₂O (0.3 hPa) or less at 30 L/min flow can indicate a ruptured filter. Discard the filter.
- Filter resistance greater than 2.4 cmH₂O (2.4 hPa) at 60 L/min flow or 1.2 cmH₂O (1.2 hPa) at 30 L/min flow can indicate an occluded filter.

For reusable filters, autoclave and check the resistance again.
For single-patient use filters, discard and replace with a new filter.

7.4.3 Daily or as required: collector vial and drain bag

Warning

- Empty the collector vial before fluid reaches the maximum fill line. Collector vial overflow can allow fluid to enter the filter or patient circuit, and can increase flow resistance.
 - If you remove the collector vial while the patient is connected to the ventilator, the result can be loss of circuit pressure, ventilator autotriggering, or direct contact with biohazardous liquid.
-

- When you change the patient circuit, autoclave or disinfect the reusable collector vials. Discard single-use collector vials.
- To avoid increased expiratory resistance, empty the collector vial before liquid reaches the maximum fill line (see Figure 7-1). Under certain conditions, the collector vial can fill in as little as two (2) hours.

7.4.3.1 How to remove the collector vial

- 1 Turn the ring at the bottom of the exhalation filter to release the vial.
- 2 Replace the empty vial.
- 3 Turn the ring to lock the vial into place on the expiratory filter.

NOTE:

If you remove the collector vial during normal ventilation, the ventilator will announce a CIRCUIT DISCONNECT alarm.

7.4.3.2 How to remove the drain bag

- 1 Squeeze the clamp to drain liquid from the collector vial into the drain bag.
- 2 When the drain bag is full, disconnect the bag from the tubing.
- 3 Install the bag fitting onto tab to seal the bag before disposal.
- 4 Discard bag. (See Figure 7-1).

Discard the drain bag and tubing every 24 hours (or as needed), and at every circuit change.

Warning

Do not attempt to clean, reprocess, or reuse the drain bag as this poses the risk of infection to medical personnel and the patient.

NOTE:

The clamp is reusable. Be sure to remove it before you discard the bag.

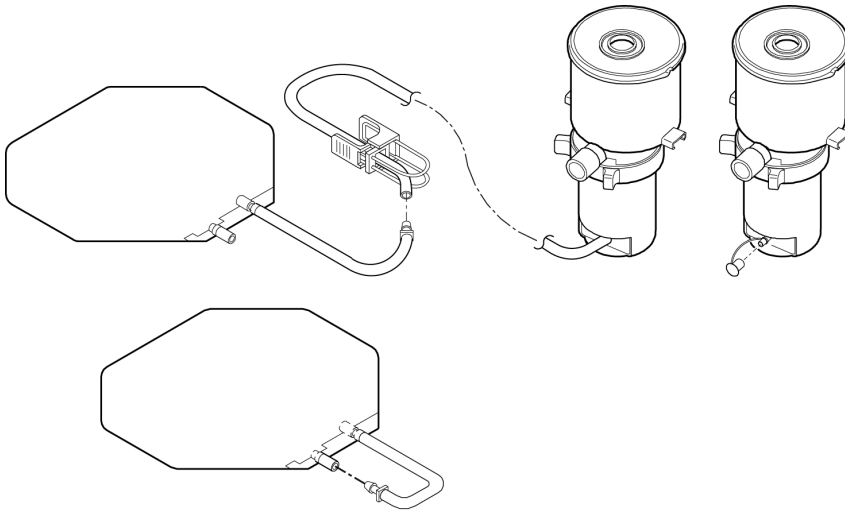

VEN_10751_A

Figure 7-1. How to empty the collector vial and seal the drain bag

7.4.4 Daily or as required: in-line water traps

Drain as required.

7.4.5 Every 250 hours: compressor inlet filter

The compressor inlet filter provides pre-filtration for the compressor inlet silencer filter. The inlet filter is located in the upper portion of the front panel of the compressor.

Remove and clean the filter more often than the recommended preventive maintenance schedule of every 250 hours if necessary. Some environments can cause particulate to collect more quickly.

- 1** To remove inlet filter, gently pull at one corner.
- 2** Wash the filter in a mild soap solution.
- 3** Rinse filter well and dry thoroughly to ensure an unrestricted flow of air through the compressor compartment.

Replace filter if it is damaged.

- 4 To install the inlet filter, align the clean dry filter over the opening in the front panel of the compressor. Gently tuck in the edges of the filter.



Figure 7-2. 806 compressor with inlet filter

7.4.6 Every year: ventilator inspection

Inspect the ventilator exterior for evidence of mechanical damage and for label illegibility. If damage or label illegibility is noted, have a qualified service person service the ventilator.

7.4.6.1 Every year or as necessary: oxygen sensor

The ventilator's oxygen sensor has a nominal life of one year. Its actual life depends on the operating environment. Operation at higher temperatures or FIO₂ levels can result in shorter sensor life.

The 840 BDU with a removable cover located on the right hand top edge of the BDU allows the operator to conveniently replace the oxygen sensor.

Earlier 840 ventilators that do not have this access cover require replacement of the oxygen sensor by qualified service personnel.

7.4.6.2 Oxygen sensor replacement procedure

Warning

To prevent bodily injury or death, do not attempt any ventilator service while a patient, or other person, is connected to the ventilator.

Warning

To prevent possible personal injury, always disconnect air and oxygen sources from the ventilator before replacing the oxygen sensor.

Warning

To prevent electrical shock hazard and possible personal injury, always disconnect electrical power sources before replacing the oxygen sensor.

Warning

Use personal protective equipment whenever exposure to toxic fumes, vapor, dust particles, blood pathogens, and other transmittable diseases and hazardous material can be expected. If in doubt, consult an environmental, health, and safety specialist or an industrial hygienist before performing routine maintenance procedures.

Warning

When you replace the oxygen sensor, be sure to familiarize yourself with, and adhere to all posted and stated safety warning and caution labels on the ventilator and its components. Failure to adhere to such warnings and cautions at all times may result in injury or property damage.

Warning

To prevent possible personal injury, never attempt to push or pull a ventilator installed on a cart, while the brakes are set on the casters.

Warning

To prevent possible personal injury and equipment damage, make sure the brakes on the casters are locked to prevent inadvertent movement of the ventilator during routine maintenance.

Warning

To prevent possible personal injury and equipment damage, have someone assist you when lifting the ventilator or any of its major components.

Warning

Investigate and determine the cause of any detected ventilator abnormality. Before you place a patient on the ventilator, have the ventilator repaired or contact Puritan Bennett Technical Support or your local representative for additional assistance.

- 1 Locate the flexible oxygen sensor access cover on the top edge of the cabinet.
- 2 Firmly push the center of the lower flap of the access cover until the lower flap is dislodged from the cabinet.

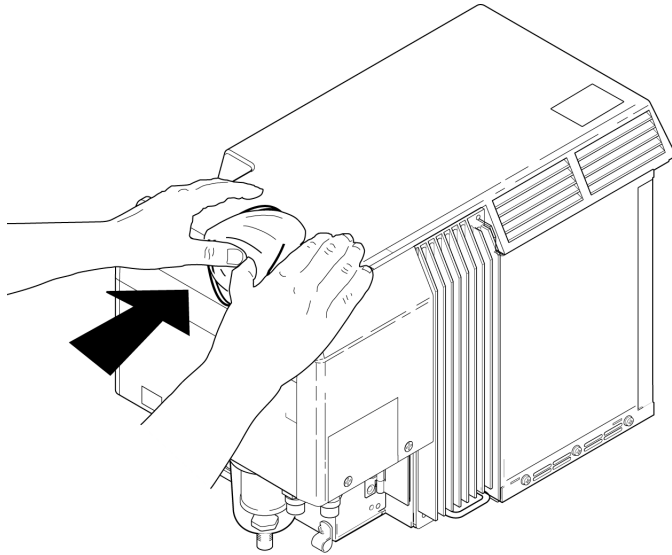

VEN_10623_A

Figure 7-3. Dislodge the O₂ sensor access cover

- 3 Pinch the bottom and top flaps of the access cover firmly together and pull the access cover away from the cabinet to remove. The oxygen sensor is the white component mounted in the check valve housing.

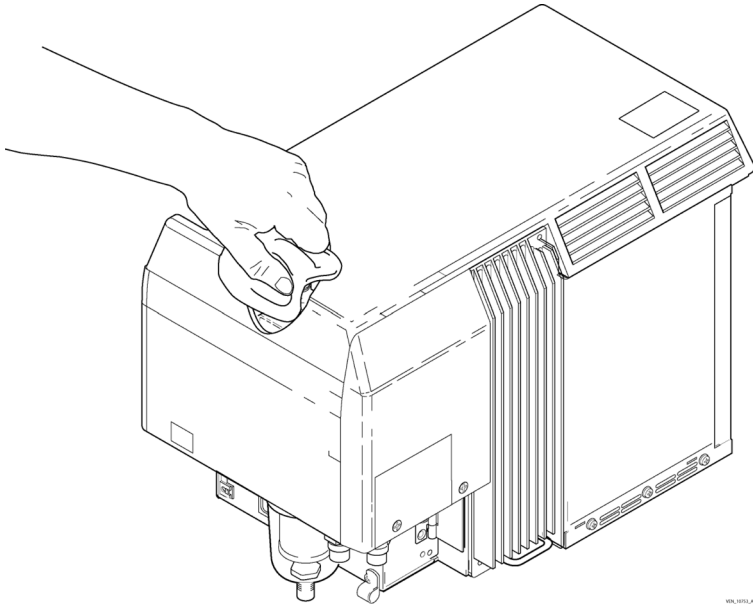
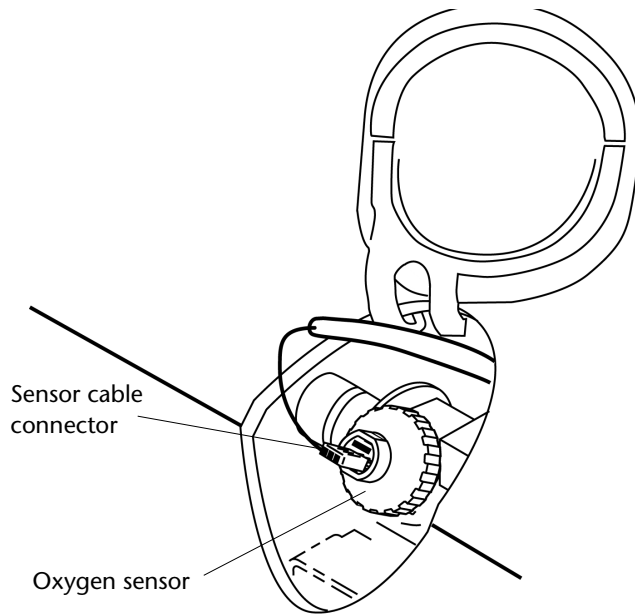

Figure 7-4. Open O₂ sensor access port

NOTE:

The access cover is permanently attached to the instrument by a retaining strap.



VEN_10624_A

Figure 7-5. Locate O₂ sensor

- 4 Locate the small white tab next to the sensor cable connector inside of the recessed top of the sensor. Press this tab away from the sensor cable connector to release the sensor cable connector. Continue to depress this tab while you gently pull the connector from the oxygen sensor.

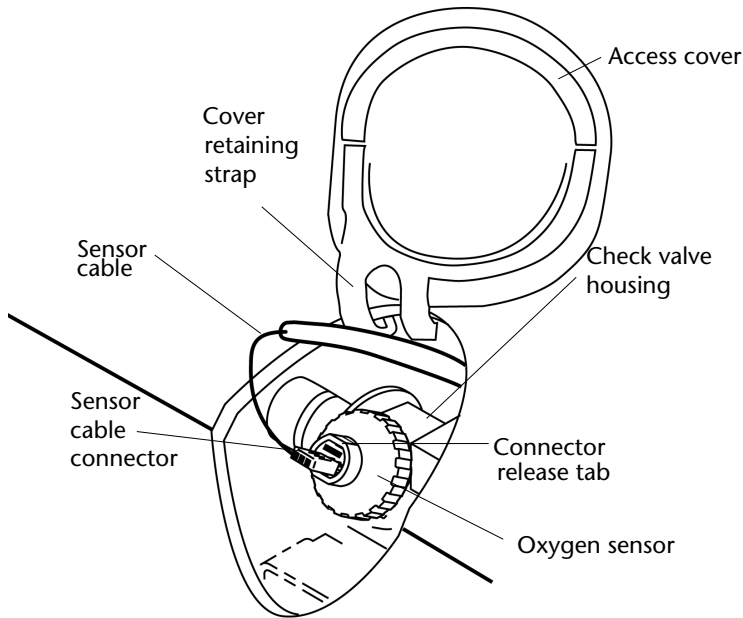

VEN_10624_A

- 5 Unscrew (counter-clockwise) and remove the oxygen sensor.
- 6 Remove the replacement oxygen sensor and its O-ring from the packaging.
- 7 Slide the O-ring onto the threaded base of the sensor. Seat the O-ring at the base of the sensor, above the threads.

Caution

The O-ring must be properly seated on the oxygen sensor before installation in the ventilator. Failure to properly seat the O-ring can result in leaks.

- 8 Insert the threaded base of the oxygen sensor into the check valve housing and screw (clockwise) the oxygen sensor into the housing until snug.

Caution

Finger-tighten the oxygen sensor without using excessive force. If the sensor is overtightened, the sensor body can crack. Ensure the sensor is not cross-threaded as it is screwed into the check valve housing.

- 9 Connect the sensor cable connector to the oxygen sensor, orienting the ridge on the cable connector towards the white release tab on the oxygen sensor. Align the pins of the sensor with the cable connector and push the connector into place.
- 10 Replace the access port cover by first sliding the top flap of the cover into the opening on the top of the ventilator cabinet.
- 11 Then, using both thumbs, simultaneously press the two outside corners of the lower flap at the cabinet's edge, fitting them into the cabinet opening.
- 12 Continue to use both thumbs and firmly press the lower flap into place. Work your thumbs around the flap from the outside corners to the bottom center to seal the access cover. Ensure the cover properly seals the cabinet opening.
- 13 Calibrate oxygen sensor by pressing 100% O₂/CAL 2 min key or INCREASE O₂ 2 min key. See page TR 15-6 for more information on calibrating the oxygen sensor. Verify that this calibration passes.
- 14 Run an SST to check the system before you place a patient on the ventilator.

7.5 Additional preventive maintenance procedures

There are additional preventive procedures that must be performed only by qualified service personnel.

Table 7-4 provides a summary of these preventive maintenance intervals and procedures. Complete details for each service preventive maintenance procedure are contained in the *Puritan Bennett 800 Series Ventilator System Service Manual*.

Table 7-4: Service preventive maintenance procedures and intervals

Frequency	Part	Maintenance
Every 6 months	Entire ventilator	Run Extended Self Test (EST).
Every year	Atmospheric pressure transducer, expiratory valve, flow sensors, and vent inop test	Perform calibration/test.
	Entire ventilator	Run performance verification. This includes running an electrical safety test and inspecting ventilator for mechanical damage and for label illegibility.
When ventilator location changes by 1000 feet of altitude	Atmospheric pressure transducer	Perform atmospheric pressure transducer calibration.
Every 2 years or as necessary	BPS internal battery pack	Replace BPS internal battery pack. Actual BPS life depends on the history of use and ambient conditions.
Every 10,000 hours	Various parts	Install appropriate preventive maintenance kits.

7.6 Storage

If you are storing the ventilator for 6 months or longer, Puritan Bennett recommends disconnecting the BPS or recharging it every 3 to 6 months, depending on storage temperatures (see specifications, Appendix A).

Caution

- *Disconnect the oxygen supply if you do not intend to use the ventilator immediately.*
 - *To avoid damaging the ventilator, do not place the cart on its back or side with the breath delivery unit (BDU) or GUI installed. To store or move the cart on its back or side, disconnect and remove the GUI and BDU from the cart first.*
-

NOTE:

An audible alarm will sound for at least 2 minutes after power is lost if no batteries are connected.

7.7 Repacking and shipping

If it is necessary to ship the ventilator for any reason, use the original packing materials. If those materials are not available, order a repacking kit. Refer to the *Puritan Bennett 800 Series Ventilator System Service Manual* for repacking instructions.

This page is intentionally blank.

Specifications

Appendix A provides the following specifications for the Puritan Bennett™ 840 Ventilator System:

- Physical
- Environmental
- Power
- Compliance and approvals
- Technical
- Ranges, resolutions, and accuracies for ventilator settings, alarm settings, and monitored data

A.1 Physical characteristics

This page is intentionally blank.

Table A-1: Physical characteristics

Weight	<p>Breath delivery unit (BDU): 19.5 kg (43.0 lb)</p> <p>Graphic user interface (GUI): 6.7 kg (14.7 lb)</p> <p>802 Backup power source (BPS) (for use with RTA cart): 7.6 kg (16.8 lb)</p> <p>803 Extended BPS (for use with RTA cart): (with battery pack, mounting bracket, and backstop) 19.5 kg (43 lb)</p> <p>RTA Cart: 15.5 kg (34.2 lb)</p> <p>Puritan Bennett 800 Series Ventilator Compressor Mount Cart (with one-hour BPS): 31.6 kg (69.7 lb)</p> <p>Puritan Bennett 800 Series Ventilator Compressor Mount Cart (with four-hour BPS): 37.7 kg (83.1 lb)</p> <p>Puritan Bennett 800 Series Ventilator Pole Cart (with one-hour battery): 34.4 kg (75.8 lb)</p> <p>Puritan Bennett 800 Series Ventilator Pole Cart (with four-hour battery): 40.5 kg (89.3 lb)</p> <p>804 Compressor unit (no longer available): 31.6 kg (69.7 lb)</p> <p>806 Compressor unit (100 V, 120 V): 23.6 kg (52 lb)</p> <p>806 Compressor unit (220 V): 24.5 kg (54 lb)</p>
--------	--

Table A-1: Physical characteristics (cont)

Dimensions	<p>BDU: 330 mm high x 457 mm wide x 254 mm deep (13 in. high x 18 in. wide x 10 in. deep)</p> <p>GUI: 460 mm high x 394 mm wide x 170 mm deep (18.1 in. high x 15.5 in. wide x 6.7 in. deep)</p> <p>802 BPS: 83 mm high x 244 mm wide x 254 mm deep (3.25 in. high x 9.6 in. wide x 10 in. deep)</p> <p>803 BPS (extended BPS for use with RTA cart): 95 mm high x 438 mm wide x 260 mm deep includes housing and bracket(3.75 in. high x 17.25 in. wide x 10.25 in. deep)</p> <p>RTA Cart: 998 mm high x 582 mm wide x 602 mm deep (39.3 in. high x 22.9 in. wide x 23.7 in. deep)</p> <p>Puritan Bennett 800 Series Ventilator Compressor Mount Cart: 1041 mm high x 686 mm wide x 839 mm deep (41 in. high x 27 in. wide x 33 in. deep with wheels in outermost position)</p> <p>Puritan Bennett 800 Series Ventilator Pole Cart: 1041mm high x 686 mm wide x 839 mm deep (41 in. high x 27 in. wide x 33 in. deep with wheels in outermost position)</p> <p>804 Compressor (no longer available): 417 mm high x 458 mm wide x 362 mm deep (16.4 in. high x 18 in. wide x 14.25 in. deep)</p> <p>806 Compressor: 425 mm high x 458 mm wide x 362 mm deep (17 in. high x 18 in. wide x 14.25 in. deep)</p>
------------	--

Table A-1: Physical characteristics (cont)

Connectors	<p>Inspiratory limb connector: ISO 22-mm conical male</p> <p>Expiratory limb connector (on expiratory filter): ISO 22-mm conical male</p> <p>Air and oxygen inlets: DISS male, DISS female, NIST, Air Liquide, or SIS fitting (depending on country and configuration)</p>
Gas mixing system	<p>Range of flow from the mixing system: Can be set to 150 L/min standard temperature and pressure, dry (STPD).</p> <p>Additional flow is available (up to 30 L/min for neonatal circuit type, up to 80 L/min for pediatric circuit type, and up to 200 L/min for adults circuit type) for compliance compensation.</p> <p>Leakage from one gas system to another: Meets standard</p> <p>Operating pressure range: 35 to 100 psi (241 to 690 kPa)</p> <p>Air/oxygen regulator bleed: Up to 3 L/min</p>
Alarm volume	45 dB(A) to 85 dB(A)

A.2 Environmental requirements

Table A-2: Environmental requirements

Temperature	Operating: 10 to 40 °C (50 to 104 °F) at 10 to 95% relative humidity, noncondensing Storage: -20 to 50 °C (-4 to 122 °F) at 10 to 95% relative humidity, noncondensing
Atmospheric pressure	Operating: 10.2 to 15.4 psi (700 to 1060 hPa) Storage: 7.3 to 15.4 psi (500 to 1060 hPa)
Altitude	Operating: -1350 to 10,000 ft (-443 to 3280 m) Storage: 20,000 ft (Up to 6560 m)

A.3 Pneumatic specifications

Table A-3: Pneumatic specifications

Oxygen and air inlet supplies	Pressure: 35 to 100 psi (241 to 690 kPa)
Warning Due to excessive restriction of the Air Liquide, SIS, and Dräger hose assemblies, reduced ventilator performance levels may result when oxygen or air supply pressures < 50 psi (345 kPa) are employed.	
	Flow: Maximum of 200 L/min

Table A-3: Pneumatic specifications (cont)

<p>Oxygen sensor life</p>	<p>The oxygen sensor should be replaced one year after the date of its manufacture, <i>or as often as necessary</i>. Actual sensor life depends on operating environment; operation at higher temperature or O₂% levels can shorten the sensor life.</p>
<p>Gas mixing system</p>	<p>Range of flow from the mixing system: Can be set to 150 L/min standard temperature and pressure, dry (STPD). Additional flow is available (up to 30 L/min for neonatal circuit type, up to 80 L/min for pediatric circuit type, and up to 200 L/min for adult circuit type) for compliance compensation.</p> <p>Leakage from one gas system to another: Meets standard IEC 60601-2-12:2001.</p> <p>Operating pressure range: 35 to 100 psi (241 to 690 kPa)</p> <p>Air/oxygen regulator bleed: Up to 3 L/min</p>

A.4 Electrical specifications

Table A-4: Electrical specifications

Input power	Ventilator operation without compressor: 120 V~, 60 Hz; 4.5 A Ventilator operation with compressor: 120 V~, 60 Hz; 10.1 A Mains overcurrent release: Ventilator: 5 A Auxiliary mains: 10 A
<p>NOTE:</p> <p>The input power specifications listed above are for ventilators with Fisher & Paykel MR730 humidifiers, and set up with the following ventilator parameters at 22 °C ambient temperature:</p> <ul style="list-style-type: none">• Mode: A/C• Mandatory type: PC• IBW: 85 kg• f_{TOT}: 20/min• P_{SUPP}: 30 cmH₂O• T_i: 1 second• Rise time percent: 50%• O₂ %: 50%• P_{PEAK}: 50 cmH₂O• P_{SENS}: 3 cmH₂O	

Table A-4: Electrical specifications (cont)

Leakage current	Earth leakage current: 300 μ A Enclosure/patient leakage current: 100 μ A maximum Humidifier leakage current: 50 μ A maximum Patient auxiliary leakage current: Not applicable.
<p>Warning</p> <p>In the event of a defective earth conductor, an increase in patient leakage current to a value that exceeds the allowable limit may occur if you connect equipment to the auxiliary mains socket outlet(s) (that is, the humidifier or compressor connection).</p>	
Alarm volume	45 dB(A) to 85 dB(A)

Table A-4: Electrical specifications (cont)

<p>802 Backup Power Source (BPS) and newer Puritan Bennett 800 Series Ventilator carts with one-hour BPS or battery</p>	<p>24 V DC, 7 Ah</p> <p>Operating time (for a new, fully charged battery): At least 60 minutes (30 minutes on ventilators built prior to July 2007). Actual duration depends on ventilator settings, battery age, and level of battery charge.</p> <p>Recharge time: Automatically recharges within 8 hours maximum while ventilator is connected to AC power.</p> <p>Shelf life: 24 months from date of manufacture.</p> <p>Storage conditions: Store at -20 to 50 °C (-4 to 122 °F), 25 to 85% relative humidity; avoid direct sunlight.</p> <p>Recharge requirements:</p> <p>Every 6 months when storage temperature is -20 to 29 °C (-5 to 84 °F)</p> <p>Every 3 months when storage temperature is 30 to 40 °C (86 to 104 °F)</p> <p>Every 2 months when storage temperature is 41 to 50 °C (105 to 122 °F).</p>
<p>803 Extended Backup Power Source and newer carts with four-hour BPS or battery</p>	<p>24 V DC, 17 Ah</p> <p>Operating time (for a new, fully charged battery): At least 4 hours. Actual duration depends on ventilator settings, battery age, and level of battery charge.</p> <p>Recharge time: Automatically recharges within 20 hours maximum while ventilator is connected to AC power.</p> <p>Shelf life: 24 months from date of manufacture.</p> <p>Storage conditions: Store at -20 to 50 °C (-4 to 122 °F), 25 to 85% relative humidity; avoid direct sunlight.</p> <p>Recharge requirements:</p> <p>Every 6 months when storage temperature is -20 to 29 °C (-5 to 84 °F)</p> <p>Every 3 months when storage temperature is 30 to 40 °C (86 to 104 °F)(86 to 104 °F)</p> <p>Every 2 months when storage temperature is 41 to 50 °C (105 to 122 °F).</p>

Table A-4: Electrical specifications (cont)

	<p>NOTE: BPS battery life specifications are approximate. To ensure maximum battery life, maintain full charge and minimize the number of complete discharges.</p>
--	---

A.5 Compliance and approvals

The Puritan Bennett 840 Ventilator System was developed in accordance with pertinent FDA guidances and North American and International standards (Table A-5).

The ventilator's IEC 60601-1/EN 60601-1 classification is Protection class I, Type B, internally powered, IPX1 drip-proof equipment, continuous operation.

Table A-5: Compliance and approvals



Standards/certifications	Configurations	Certification agency
North America		
Authorized to bear the CSA certification mark, signifying the product has been evaluated to the applicable ANSI/Underwriters Laboratories Inc. (UL) and CSA standards for use in the US and Canada. CSA Std. No. 601-1-M90 CSA 601-1 Supplement 1:1994 CSA Std. No. 60601-2.12-1994 UL No. 60601-1 (1st Edition) IEC 60601-1:1988 IEC 60601-1 Amendment 1:1991 IEC 60601-1 Amendment 2:1995 IEC 60601-2-12:2001  NRTL/C IEC 60601-1-2:2007	120 V, 60 Hz 220 – 240 V, 50 Hz 220 – 240 V, 60 Hz	Canadian Standards Association (CSA)
International		
CB scheme certification: IEC 60601-1:1988 IEC 60601-1 Amendment 1:1991 IEC 60601-1 Amendment 2:1995 IEC 60601-2-12:2001	100 V, 50/60 Hz 120 V, 60 Hz 220 – 240 V, 50 Hz 220 – 240 V, 60 Hz	Canadian Standards Association (CSA)

Table A-5: Compliance and approvals (cont)

Standards/certifications	Configurations	Certification agency
IEC 60601-1-2: 2001+A1:2004	100 V, 50/60 Hz 120 V, 60 Hz 220 – 240 V, 50 Hz 220 – 240 V, 60 Hz	Manufacturer self-certification
European		
Approved to the type test requirements of Annex III of the Medical Device Directive. EN 60601-1:1990 EN 60601-1 Amendment 1:1993 EN 60601-1 Amendment 11:1993 EN 60601-1 Amendment 12:1993 EN 60601-1 Amendment 2:1995 EN 60601-1 Amendment 13:1996 IEC 60601-2-12:2001 	220 – 240 V, 50 Hz 220 – 240 V, 60 Hz	TÜV Product Service
EN 60601-1-2:2001+A1:2006		Manufacturer self-certification

A.5.1 Manufacturer’s Declaration

The following tables contain the manufacturer’s declarations for the Puritan Bennett 840 Ventilator System electromagnetic emissions, electromagnetic immunity, recommended separation distances between ventilator and portable and mobile RF communications equipment, and a list of compliant cables.

Warning

Portable and mobile RF communications equipment can affect the performance of the Puritan Bennett 840 Ventilator System. Install and use this device according to the information contained in this manual.

Warning

The Puritan Bennett 840 Ventilator System should not be used adjacent to or stacked with other equipment, except as may be specified elsewhere in this manual. If adjacent or stacked use is necessary, the Puritan Bennett 840 Ventilator System should be observed to verify normal operation in the configurations in which it will be used.

NOTE: This is a class A product and is intended to be used in a hospital environment only. If used outside of the hospital environment, this equipment may not offer adequate protection to radio-frequency communication services. The user may be required to take mitigation measures, such as relocating or re-orienting the equipment.

Table A-6: Electromagnetic Emissions

The Puritan Bennett 840 Ventilator System is intended for use in the electromagnetic environment specified below. The customer or the user of the Puritan Bennett 840 Ventilator System should ensure it is used in such an environment.		
Emissions Test	Compliance	Electromagnetic environment-guidance
Radiated RF emissions CISPR 11	Group 1 Class A	The Puritan Bennett 840 Ventilator System uses RF energy only for its internal functions. Therefore, its RF emissions are very low and are not likely to cause any interference in nearby electronic equipment.

Table A-6: Electromagnetic Emissions (cont)

<p>The Puritan Bennett 840 Ventilator System is intended for use in the electromagnetic environment specified below. The customer or the user of the Puritan Bennett 840 Ventilator System should ensure it is used in such an environment.</p>		
<p>Conducted RF emissions CISPR 11</p>	<p>Group 1 Class A</p>	<p>The Puritan Bennett 840 Ventilator System is suitable for use in all establishments including domestic establishments and those directly connected to the public low-voltage power supply network that supplies buildings used for domestic purposes.</p>
<p>Harmonic emissions IEC 61000-3-2</p>	<p>Class A</p>	
<p>Voltage fluctuations/ flicker emissions IEC 61000-3-3</p>	<p>Complies</p>	

Table A-7: Electromagnetic Immunity

<p>The Puritan Bennett 840 Ventilator System is intended for use in the electromagnetic environment specified below. The customer or the user of the Puritan Bennett 840 Ventilator System should ensure it is used in such an environment.</p>			
<p>Immunity test</p>	<p>IEC 60601-1-2 test level</p>	<p>Compliance level</p>	<p>Electromagnetic environment– guidance</p>
<p>Electrostatic discharge (ESD) IEC 61000-4-2</p>	<p>± 6 kV contact ± 8 kV air</p>	<p>± 6 kV contact ± 8 kV air</p>	<p>Floors should be wood, concrete, or ceramic tile. If floors are covered with synthetic material, the relative humidity should be at least 30%.</p>
<p>Electrical fast transient/burst IEC 61000-4-4</p>	<p>± 2 kV for power supply lines ± 1 kV for input/output lines</p>	<p>± 2 kV for power supply lines ± 1 kV for input/output lines</p>	<p>Mains power quality should be that of a typical commercial or hospital environment.</p>
<p>Surge IEC 61000-4-5</p>	<p>± 1 kV lines/lines ± 2 kV lines/earth</p>	<p>± 1 kV lines/lines ± 2 kV lines/earth</p>	<p>Mains power quality should be that of a typical commercial or hospital environment.</p>

Table A-7: Electromagnetic Immunity (cont)

<p>The Puritan Bennett 840 Ventilator System is intended for use in the electromagnetic environment specified below. The customer or the user of the Puritan Bennett 840 Ventilator System should ensure it is used in such an environment.</p>			
Immunity test	IEC 60601-1-2 test level	Compliance level	Electromagnetic environment-guidance
<p>Voltage dips, short interruptions and voltage variations on power supply input lines IEC 61000-4-11</p>	<p>< 5% U_T (> 95% dip in U_T for 0.5 cycle)</p>	<p>< 5% U_T (> 95% dip in U_T for 0.5 cycle)</p>	<p>Mains power quality should be that of a typical commercial or hospital environment. If the user of the Puritan Bennett 840 Ventilator System requires continued operation during power mains interruptions, it is recommended that the Puritan Bennett 840 Ventilator System be powered from an uninterruptible power supply or a battery.</p>
	<p>40% U_T (60% dip in U_T for 5 cycles)</p>	<p>40% U_T (60% dip in U_T for 5 cycles)</p>	
	<p>70% U_T (30% dip in U_T for 25 cycles)</p>	<p>70% U_T (30% dip in U_T for 25 cycles)</p>	
	<p>< 5% U_T (> 95% dip in U_T for 5 s)</p>	<p>< 5% U_T (> 95% dip in U_T for 5 s)</p>	
<p>Power frequency (50/60 Hz) magnetic field IEC 61000-4-8</p>	<p>3 A/m</p>	<p>3 A/m</p>	<p>Power frequency magnetic fields should be at levels characteristic of a typical location in a typical commercial or hospital environment.</p>
<p>NOTE: U_T is the AC mains voltage prior to application of the test level.</p>			

Table A-8: Electromagnetic Immunity – conducted and radiated RF

<p>The Puritan Bennett 840 Ventilator System is intended for use in the electromagnetic environment specified below. The customer or the user of the Puritan Bennett 840 Ventilator System should ensure it is used in such an environment.</p>			
Immunity test	IEC 60601-1-2 test level	Compliance level	Electromagnetic environment-guidance
<p>Conducted RF IEC 61000-4-6</p>	<p>3 Vrms 150 kHz to 80 MHz outside ISM bands^a</p> <p>10 Vrms inside ISM bands^a</p>	<p>3 Vrms 150 kHz to 80 MHz outside ISM bands</p> <p>10 Vrms inside ISM bands</p>	<p>Portable and mobile RF communications equipment should be used no closer to any part of the Puritan Bennett 840 Ventilator System, including cables, than the recommended separation distance calculated from the equation applicable to the frequency of the transmitter.</p> <p>Recommended separation distance</p> $d = 0.35\sqrt{P}$ $d = 1.2\sqrt{P}$ <p>$d = 1.2\sqrt{P}$ 80 MHz to 800 MHz</p> <p>$d = 2.3\sqrt{P}$ 800 MHz to 2.5 GHz</p>
<p>Radiated RF IEC 61000-4-3</p>	<p>10 V/m 80 MHz to 2.5 GHz</p>	<p>10 V/m 80 MHz to 2.5 GHz</p>	<p>$d = 1.2\sqrt{P}$ 80 MHz to 800 MHz</p> <p>$d = 2.3\sqrt{P}$ 800 MHz to 2.5 GHz</p>

Table A-8: Electromagnetic Immunity – conducted and radiated RF (cont)

where P is the maximum output power rating of the transmitter in watts (W) according to the transmitter manufacturer and d is the recommended separation distance in meters (m)^b. Field strengths from fixed RF transmitters, as determined by an electromagnetic site survey^c, should be less than the compliance level in each frequency range^d.

Interference may occur in the vicinity of equipment marked with the following symbol:



NOTE:

- At 80 MHz and 800 MHz, the higher frequency range applies.
- These guidelines may not apply in all situations. Electromagnetic propagation is affected by absorption and reflection from structures, objects, and people.

^a The ISM (industrial, scientific, and medical) bands between 150 kHz and 80 MHz are 6.765 MHz to 6.795 MHz; 13.553 MHz to 13.567 MHz; 26.957 MHz to 27.283 MHz; and 40.66 MHz to 40.70 MHz.

^b The compliance levels in the ISM frequency bands between 150 kHz and 80 MHz and in the frequency range 80 MHz to 2.5 GHz are intended to decrease the likelihood mobile/portable communications equipment could cause interference if it is inadvertently brought into patient areas. For this reason, an additional factor of 10/3 is used in calculating the recommended separation distance for transmitters in these frequency ranges.

^c Field strengths from fixed transmitters, such as base stations for radio (cellular/cordless) telephones and land mobile radios, amateur radio, AM and FM radio broadcast and TV broadcast cannot be predicted theoretically with accuracy. To assess the electromagnetic environment due to fixed RF transmitters, an electromagnetic site survey should be considered. If the measured field strength in the location in which the Puritan Bennett 840 Ventilator System is used exceeds the applicable RF compliance level above, the Puritan Bennett 840 Ventilator System should be observed to verify normal operation. If abnormal performance is observed, additional measures may be necessary, such as reorienting or relocating the Puritan Bennett 840 Ventilator System.

^d Over the frequency range 150 kHz to 80 MHz, field strengths should be less than 10 V/m.

Table A-9: Recommended separation distances between portable and mobile RF communications equipment and the Puritan Bennett 840 Ventilator System

<p>The Puritan Bennett 840 Ventilator System is intended for use in an electromagnetic environment in which radiated RF disturbances are controlled. The customer or the user of the Puritan Bennett 840 Ventilator System can help prevent electromagnetic interference by maintaining a minimum distance between portable and mobile RF communications equipment (transmitters) and the ventilator as recommended below, according to the maximum output power of the communications equipment.</p>				
<p>Rated maximum output power of transmitter (W)</p>	<p>Separation distance according to frequency of transmitter (m)</p>			
	<p>150 kHz to 80 MHz outside ISM bands $d = 0.35\sqrt{P}$</p>	<p>150 kHz to 80 MHz in ISM bands $d = 1.2\sqrt{P}$</p>	<p>80 MHz to 800 MHz $d = 1.2\sqrt{P}$</p>	<p>800 MHz to 2.5 GHz $d = 2.3\sqrt{P}$</p>
0.01	0.035	0.12	0.12	0.23
0.1	0.11	0.38	0.38	0.73
1	.35	1.2	1.2	2.3
10	1.1	3.8	3.8	7.3
100	3.5	12	12	23
<p>For transmitters rated at a maximum output power not listed above, the recommended separation distance d in meters (m) can be determined using the equation applicable to the frequency of the transmitter, where P is the maximum output power rating of the transmitter in watts (W) according to the transmitter manufacturer.</p>				
<p>NOTES:</p> <ul style="list-style-type: none"> • At 80 MHz and 800 MHz, the separation distance for the higher frequency range applies. • The ISM (industrial, scientific, and medical) bands between 150 kHz and 80 MHz are 6.765 MHz to 6.795 MHz; 13.553 MHz to 13.567 MHz; 26.957 MHz to 27.283 MHz; and 40.66 MHz to 40.70 MHz. • An additional factor of 10/3 is used in calculating the recommended separation distance for transmitters in the ISM frequency bands between 150 kHz and 80 MHz and in the frequency range 80 MHz to 2.5 GHz to decrease the likelihood mobile/portable communications equipment could cause interference if it is inadvertently brought into patient areas. • These guidelines may not apply in all situations. Electromagnetic propagation is affected by absorption and reflection from structures, objects, and people. 				

Table A-10: Compliant cables

Puritan Bennett does not supply remote alarm (nurse call) or serial port cables. In order to maintain compliance to International Electromagnetic Compatibility (EMC) standards, Puritan Bennett recommends using shielded cables for these applications.

Warning

The use of accessories and cables other than those specified, with the exception of parts sold by Puritan Bennett as replacements for internal components, may result in increased emissions or decreased immunity of the Puritan Bennett 840 Ventilator System.

4-078107-00, 4-078107-SP Power cord, latching, North America	10 ft (3 m)
4-078108-00, 4-078108-SP Power cord, latching, Europe	10 ft (3 m)
4-078109-00, 4-078109-SP Power cord, latching, Japan	10 ft (3 m)
4-078110-00, 4-078110-SP Power cord, latching, Australia	10 ft (3 m)
4-071421-00 Power cord, Denmark	10 ft (3 m)
4-071422-00 Power cord, India/S. Africa	10 ft (3 m)
4-071423-00 Power cord, Israel	10 ft (3 m)
4-078144-00 Power cord, UK	10 ft (3 m)
4-078107-00, 4-078107-SP Power cord, latching, North America	10 ft (3 m)
4-031323-00 Power cord, Italy	10 ft (3 m)
4-031325-00 Power cord, Switzerland	10 ft (3 m)

Table A-10: Compliant cables (cont)

<p>Puritan Bennett does not supply remote alarm (nurse call) or serial port cables. In order to maintain compliance to International Electromagnetic Compatibility (EMC) standards, Puritan Bennett recommends using shielded cables for these applications.</p>	
<p>Warning</p> <p>The use of accessories and cables other than those specified, with the exception of parts sold by Puritan Bennett as replacements for internal components, may result in increased emissions or decreased immunity of the Puritan Bennett 840 Ventilator System.</p>	
<p>4-075864-00 Cable assembly, GUI to BDU</p>	<p>3 ft (91 cm)</p>
<p>4-071441-00 Cable assembly, GUI to BDU</p>	<p>10 ft (3 m)</p>

A.6 Technical specifications

NOTE:

When the Puritan Bennett 840 Ventilator System pressure units are set to hPa, pressure delivery and spirometry are subject to an additional 2% error.

Table A-11: Technical Specifications

<p>Maximum limited pressure</p>	<p>127.5 cmH₂O (125 hPa)</p>
<p>Maximum working pressure</p>	<p>100 cmH₂O (98.1hPa), ensured by high pressure limit 90 cmH₂O (pressure-based ventilation)</p>

Table A-11: Technical Specifications (cont)

Measuring and display devices	<p>Pressure</p> <p>Type: Silicon solid-state differential pressure transducer</p> <p>Sensing position: Inspiratory and expiratory limbs (used to algorithmically approximate circuit wye pressure)</p> <p>Measurements:</p> <p>Mean circuit pressure Range: - 20 to 120 cmH₂O (- 20.4 to 122 hPa)</p> <p>Peak circuit pressure Range: - 20 to 130 cmH₂O (- 20.4 to 133 hPa)</p>
	<p>Volume</p> <p>Type: Hot film anemometer</p> <p>Sensing position: Exhalation compartment</p> <p>Measurements:</p> <p>Exhaled tidal volume Range: 0 to 6,000 mL</p> <p>Total minute volume Range: 0 to 99.9 L</p>
	<p>Oxygen</p> <p>Type: Galvanic cell</p> <p>Sensing position: Inspiratory manifold</p> <p>Measurement: Delivered % O₂ Range: 0 to 103%</p>
	<p>Display of settings, alarms, and monitored data</p> <p>Type: Two liquid crystal display (LCD) touch screens</p>
Minute volume (V _{E TOT}) capability	25 to 75 L/min

Table A-11: Technical Specifications (cont)

<p>Results of ventilator patient circuit testing (using circuits identified for use with the Puritan Bennett 840 Ventilator System (Figure A-1.))</p>	<p>Inspiratory pressure drop from inlet of open safety valve to outlet port without inspiratory filter: At 5 standard liters per minute (SL/min): 0.06 cmH₂O At 30 SL/min: 0.28 cmH₂O At 60 SL/min: 0.95 cmH₂O</p>
	<p>Inspiratory pressure drop across inspiratory filter: At 5 SL/min: 0.17 cmH₂O At 30 SL/min: 0.56 cmH₂O At 60 SL/min: 1.37 cmH₂O</p>
	<p>Inspiratory pressure drop from inlet of open safety valve with inspiratory filter: At 5 SL/min: 0.17 cmH₂O At 30 SL/min: 0.84 cmH₂O At 60 SL/min: 2.32 cmH₂O</p>
	<p>Pressure drop across 1.68 m (5.5 ft) inspiratory or expiratory limb with water trap, to patient wye: Neonatal patient circuit¹: Not applicable (no water trap) Pediatric patient circuit at 30 SL/min: 0.73 cmH₂O Adult patient circuit at 60 SL/min: 1.05 cmH₂O</p>

¹ Use only a neonatal patient circuit in conjunction with the *NeoMode* software option and the *NeoMode* hardware.

Table A-11: Technical Specifications (cont)

<p>Results of ventilator patient circuit testing (cont)</p>	<p>Pressure drop across 1.22 m (4 ft) inspiratory or expiratory limb without water trap, to patient wye:</p> <p>Neonatal patient circuit at 5 SL/min: 0.45 cmH₂O (inspiratory limb)</p> <p>Neonatal patient circuit at 5 SL/min: 0.40 cmH₂O (expiratory limb)</p> <p>Pediatric patient circuit at 30 SL/min: 0.56 cmH₂O</p> <p>Adult patient circuit at 60 SL/min: 0.70 cmH₂O</p>
	<p>Pressure drop across Fisher & Paykel humidifier and lead-in tube:</p> <p>Neonatal patient circuit at 5 SL/min: 0.14 cmH₂O</p> <p>Pediatric patient circuit at 30 SL/min: 0.28 cmH₂O</p> <p>Adult patient circuit at 60 SL/min: 0.93 cmH₂O</p>
	<p>Total inspiratory pressure drop:</p> <p>Neonatal patient circuit with neonatal filter/vial at 5 SL/min: 0.76 cmH₂O</p> <p>Pediatric patient circuit with water traps at 30 SL/min: 1.85 cmH₂O</p> <p>Pediatric patient circuit without water traps at 30 SL/min: 1.68 cmH₂O</p> <p>Adult patient circuit with water traps at 60 SL/min: 4.30 cmH₂O</p> <p>Adult patient circuit without water traps at 60 SL/min: 3.95 cmH₂O</p>
	<p>Expiratory pressure drop across exhalation compartment:</p> <p>At 5 SL/min: 0.21 cmH₂O (with neonatal filter and vial)</p> <p>At 30 SL/min: 1.5 cmH₂O</p> <p>At 60 SL/min: 3.40 cmH₂O</p>

Table A-11: Technical Specifications (cont)

<p>Results of ventilator patient circuit testing (cont)</p>	<p>Total expiratory pressure drop: Neonatal patient circuit with neonatal filter and vial at 5 SL/min: 0.61 cmH₂O Pediatric patient circuit with water traps at 30 SL/min: 2.23 cmH₂O Pediatric patient circuit without water traps at 30 SL/min: 2.06 cmH₂O Adult patient circuit with water traps at 60 SL/min: 4.45 cmH₂O Adult patient circuit without water traps at 60 SL/min: 4.10 cmH₂O</p> <p>Internal volume: Inspiratory pneumatics: 50 mL ± 5 mL Expiratory pneumatics: 1000 mL ± 25 mL (including expiratory filter and collector vial) The Puritan Bennett 840 Ventilator System automatically adjusts for volume losses due to gas compressibility (that is, automatic compliance compensation), subject to a maximum delivered volume of 2500 mL.</p> <p>Patient circuit testing specifications are with the ventilator powered off, and are based on the recommended configurations shown in Figure A-1. (heated wire humidifier without water traps and non-heated wire humidifier with water traps). Patient circuit part numbers are listed in Appendix B. To ensure compliance compensation functions correctly, the user must run SST with the circuit configured as intended for use on the patient.</p>
<p>Bacteria filter efficiency</p>	<p>99.97% for nominal particle size of 0.3 μm (micron) at 100 L/min</p>

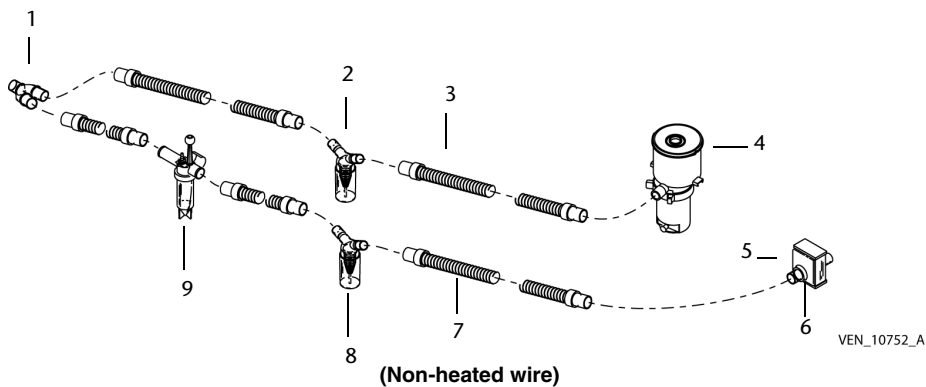
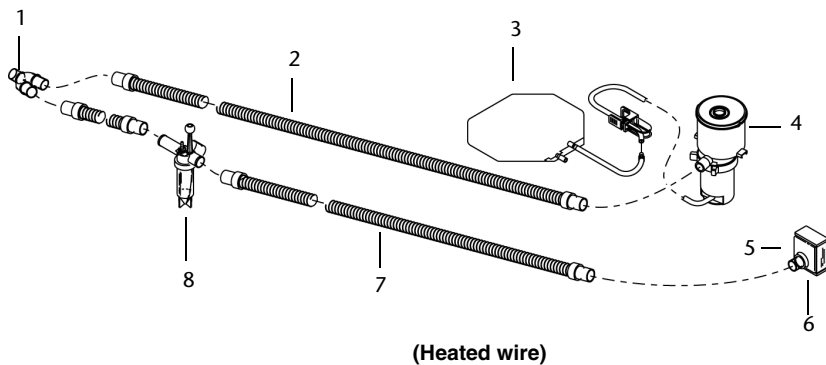

Figure A-1. Recommended patient circuit configurations

NOTE:

Refer to the *NeoMode* option addendum for the recommended neonatal patient circuit configurations.

Table A-12: Patient circuit configurations

Heated wire configuration	
Item	Description
1	Patient wye
2	Expiratory limb (smooth-bore tubing)
3	Drain bag/tubing
4	PB <i>Re/X 800</i> or <i>D/X 800</i> expiratory filter and collector vial
5	To patient connector
6	PB <i>Re/Flex</i> or <i>D/Flex</i> inspiratory filter
7	Inspiratory limb (smooth-bore tubing)
8	Nebulizer (for position only)
Non-heated wire configuration	
Item	Description
1	Patient wye
2	Water trap
3	Expiratory limb (smooth-bore tubing)
4	PB <i>Re/X 800</i> or <i>D/X 800</i> expiratory filter and collector vial
5	To patient connector
6	PB <i>Re/Flex</i> or <i>D/Flex</i> inspiratory filter
7	Inspiratory limb (smooth-bore tubing)
8	Water trap
9	Nebulizer (for position only)

A.7 Ranges, resolutions, and accuracies

- Table A-13 contains ranges, resolutions, and accuracies for ventilator settings. It also contains, where applicable, dependent ventilator settings.
- Table A-14 contains alarm settings.
- Table A-15 contains patient data.
- Table A-16 contains descriptions of other displayed data including diagnostic codes, operational time, software revision level, and date/time setting.

A.7.1 Recommended limits

Some settings have recommended limits you can override, called soft bounds. When you enter a proposed setting that exceeds the recommended limits, the ventilator sounds an alert and asks you for confirmation to override the recommended range.

Warning

The displayed pressure values are estimates and are not directly measured pressures. Displayed pressures are often good approximations of the actual pressure at the wye, but under some conditions, such as partial occlusions of the inspiratory limb, the displayed pressures will be closer to the pressure at the inspiratory port.

If the clinical circumstances suggest the validity of the displayed pressure estimates is questionable, examine the breathing circuit. Correct any occlusion and rerun SST. You can also use a separate portable manometer to measure the pressure.

A.7.2 Software options

Refer to the appropriate software option addendum for information regarding ventilator settings, alarm settings, and monitored data specific to an installed ventilation option, which include:

BILEVEL (*BiLevel* Option)

NeoMode (*NeoMode* Option)

NeoMode Update (Updated *NeoMode* Option)

NeoMode 2.0 (*NeoMode* Option capable of delivering tidal volumes as low as 2 mL)

TC (*Tube Compensation* Option)

LC (*Leak Compensation* Option)

VS, VC+ (*Volume Ventilation Plus* Option)

PAV+ (*Proportional Assist Ventilation Plus* Option)

RM (*Respiratory Mechanics* Option)

Trending (*Trending* Option)

Table A-13: Ventilator settings

Setting	Function	Range, resolution, accuracy
Apnea ventilation	A safety mode initiated if the patient does not receive a breath for an elapsed time exceeding the apnea interval.	See individual apnea settings.
Apnea expiratory time (T_E)	Same as expiratory time for non-apnea ventilation.	Range: $T_E \geq 0.2$ second Resolution: Same as for non-apnea. Accuracy: Same as for non-apnea.
Apnea flow pattern	Same as flow pattern for non-apnea ventilation.	See <i>flow pattern</i> below.

Table A-13: Ventilator settings (cont)

Setting	Function	Range, resolution, accuracy
Apnea I:E ratio	Same as I:E ratio for non-apnea ventilation.	Range: $\leq 1.00:1$ Resolution: See <i>I:E ratio</i> below. Accuracy: See <i>I:E ratio</i> below.
Apnea inspiratory pressure (P_I)	Same as inspiratory pressure for non-apnea ventilation.	See <i>inspiratory pressure</i> below.
Apnea inspiratory time (T_I)	Same as inspiratory time for non-apnea ventilation.	See <i>inspiratory time</i> below.
Apnea interval (T_A)	Defines apnea time interval after which the ventilator declares apnea. $T_A \geq 60/f_A$	Range: 10 to 60 seconds Resolution: 1 second Accuracy: +0.350 second New patient value: Neonatal: 10 s Pediatric: 15 s Adult: 20 s
Apnea mandatory type	Same as mandatory type for non-apnea ventilation.	See <i>mandatory type</i> below. New patient value: Neonatal: Same as non-apnea mandatory type when non-apnea mandatory type is PC or VC. PC when non-apnea mandatory type is VC+. Pediatric/Adult: Same as non-apnea mandatory type when non-apnea mandatory type is PC or VC. VC when non-apnea mandatory type is VC+.
Apnea $O_2\%$	Same as $O_2\%$ for non-apnea ventilation.	Range: 21 to 100%, and not below non-apnea $O_2\%$ Resolution: 1% Accuracy: See $O_2\%$ below.

Table A-13: Ventilator settings (cont)

Setting	Function	Range, resolution, accuracy
Apnea peak inspiratory flow (\dot{V}_{MAX})	Same as peak inspiratory flow for non-apnea ventilation.	See <i>peak inspiratory flow</i> below.
Apnea respiratory rate (f)	Same as respiratory rate for non-apnea ventilation. Apnea $f \geq 60/T_A$	Range: 2.0 to 40/min Resolution: 0.1/min for 2.0 to 9.9/min 1/min for 10 to 40/min Accuracy: $\pm 0.1/\text{min}$ (+ 0.6% of setting) New patient value: Neonatal: 20/min Pediatric: 14/min Adult: 10/min
Apnea tidal volume (V_T)	Sets the volume of gas delivered to the patient's lungs during a mandatory volume-based apnea breath (VC only is allowed during apnea ventilation). Apnea tidal volume is compensated for body temperature and pressure, saturated (BTPS) and the compliance of the patient circuit.	Range: Neonatal: 3 mL to 315 mL* Pediatric/Adult: 25 mL to 2500 mL (IBW-based range is 1.16 x IBW minimum; 45.7 x IBW maximum) Resolution: 0.1 mL for 3 to 5 mL* 1 mL for 5 to 100 mL 5 mL for 100 to 400 mL 10 mL for 400 to 2500 mL Accuracy: Compliance- and BTPS-compensated: For $TI < 600$ ms: ± 10 mL (+ 10% x (600 ms/ TI) of setting) For $TI > 600$ ms: ± 10 mL (+ 10% of setting) New patient value: MAX (3 mL, (7.25 * IBW))* *Assumes NeoMode 2.0 software option is installed

Table A-13: Ventilator settings (cont)

Setting	Function	Range, resolution, accuracy
Constant during rate change	Specifies which of the three breath timing variables is directly operator-adjustable and remains constant when the set respiratory rate changes. Applicable in pressure control (PC) ventilation and Volume Control Plus ventilation (VC+) only.	Timing variables: Inspiratory time, I:E ratio, or expiratory time; T_H , T_L , $T_H:T_L$ in BILEVEL Resolution: Not applicable Accuracy: Not applicable New patient value: Inspiratory time
	<hr/> <p>NOTE: You can change the value of the selected variable at any time, but the value does not change as a result of changing the respiratory rate setting.</p> <hr/>	
Disconnect sensitivity (D_{SENS})	Sets the allowable loss (in %) of returned volume which, if exceeded, causes the ventilator to detect a CIRCUIT DISCONNECT alarm. The greater the setting, the more returned volume must be lost before CIRCUIT DISCONNECT is detected. For example, a setting of 95% means more than 95% of the returned volume must be lost before the ventilator detects a CIRCUIT DISCONNECT alarm.	Range: 20 to 95% Resolution: 1% Accuracy: Not applicable New patient value (INVASIVE Vent Type): 75% New patient value (NIV Vent Type): OFF
Expiratory sensitivity (E_{SENS})	The percent of peak inspiratory flow at which the ventilator cycles from inspiration to exhalation for spontaneous breaths.	Range: 1 to 80% (1 to 10 L/min when Spontaneous Type is PA) Resolution: 1% Accuracy: Not applicable New patient value: 25% (3 L/min when Spontaneous Type is PA)

Table A-13: Ventilator settings (cont)

Setting	Function	Range, resolution, accuracy
Expiratory time (T_E)	Sets the expiratory period for pressure control (PC or VC+) mandatory breaths.	Range: $T_E \geq 0.2$ second Resolution: 0.01 second Accuracy: ± 0.01 second New patient value: 60/f (new patient) - T_I (new patient) seconds Depends on: I:E ratio, T_I , f
Flow pattern (available only when mandatory type is VC)	The gas flow pattern of mandatory volume-controlled (VC) breaths. Flow pattern is not selectable when the mandatory type is PC or VC+.	Range: Square or descending ramp Resolution: Not applicable Accuracy: Not applicable New patient value: All circuit types: Descending ramp
Flow sensitivity (V_{SENS})	The flow inspired by the patient triggers the ventilator to deliver a mandatory or spontaneous breath (when flow triggering is selected).	Range: Neonatal: 0.1 to ≤ 10 L/min Pediatric/Adult: 0.2 to ≤ 20 L/min Resolution: 0.1 L/min Accuracy: Not applicable New patient value: Neonatal: 0.5 L/min Pediatric: 2.0 L/min Adult: 3.0 L/min
High spontaneous inspiratory time limit ($\uparrow T_{I\ SPONT}$) (Available when Vent Type is NIV, only)	Sets the maximum inspiratory time allowed during non-invasive ventilation. If the inspiratory time reaches the set limit, the ventilator transitions to exhalation.	Range: Neonatal: ≥ 0.2 sec to $(1 + (0.1 \times IBW))$ sec Pediatric/Adult: ≥ 0.4 sec to $(1.99 + (0.02 \times IBW))$ sec New patient value: Neonatal: $(1 + (0.1 \times IBW))$ sec Pediatric/Adult: $(1.99 + (0.02 \times IBW))$ sec Depends on: Circuit type, IBW

Table A-13: Ventilator settings (cont)

Setting	Function	Range, resolution, accuracy
Humidification type	Indicates the type of humidification device used on the ventilator. Type can be changed during SST and normal ventilation (see the <i>More Settings</i> screen).	Range: HME, non-heated expiratory tube, or heated expiratory tube Resolution: Not applicable Accuracy: Not applicable New patient value: Previous setting
Humidifier volume	The empty volume of the currently installed humidifier (specified volume, not compressible volume).	Range: 100 mL to 1000 mL Resolution: 10 mL New patient value: Previous setting

Table A-13: Ventilator settings (cont)

Setting	Function	Range, resolution, accuracy
Ideal body weight (IBW)	<p>Indicates an approximate value for patient's body weight, assuming normal fat and fluid levels.</p> <p>The IBW establishes the absolute limits on tidal volume and peak flow. The ventilator uses IBW to determine the initial new patient settings for tidal volume, peak flow, and volume-related alarms.</p>	<p>Range:</p> <p>Neonatal: 0.3 kg (0.66 lb) to 7.0 kg* (15 lb)</p> <p>Pediatric: 3.5 kg (7.7 lb) to 35 kg (77 lb)</p> <p>Soft bounds at 7 kg and 24 kg</p> <p>Adult: 7.0 kg (15 lb) to 150 kg (330 lb)</p> <p>Soft bound at 25 kg</p> <p>Resolution:</p> <p>0.1 kg for 0.3 to 3.5 kg* 0.5 kg for 3.5 to 10 kg 1.0 kg for 10 to 50 kg 5 kg for 50 to 100 kg 10 kg for 100 to 150 kg</p> <p>Accuracy: Not applicable</p> <p>New patient value:</p> <p>Neonatal: 3.0 kg Pediatric: 15.0 kg Adult: 50 kg</p> <p>Depends on: Circuit type</p> <p>*Assumes NeoMode 2.0 software option is installed</p>

Table A-13: Ventilator settings (cont)

Setting	Function	Range, resolution, accuracy
I:E ratio or $T_H:T_L$ in BILEVEL	Sets the ratio of inspiratory time to expiratory time. Applicable to pressure control (PC) mandatory breaths in SIMV, VC+, BILEVEL or A/C only.	Range: $1:299 \leq I:E \leq 4.00:1$ $1:299 < T_H:T_L < 149:1$ (BILEVEL mode only) Resolution: 1 for 1:299 to 1:100 0.1 for 1:99.9 to 1:10.0 0.01 for 1:9.99 to 4.00:1 Accuracy: ± 0.01 second of the inspiratory time determined by the I:E ratio and respiratory rate settings Depends on: T_I , T_E or T_H , T_L
Inspiratory pressure (P_I)	Sets the inspiratory pressure at the patient wye (above PEEP) during a pressure control (PC) mandatory breath.	Range: 5 to 90 cmH ₂ O; $P_I + PEEP < 90$ cmH ₂ O; $P_I + PEEP + 2$ cmH ₂ O $\leq \uparrow P_{PEAK}$ Resolution: 1.0 cmH ₂ O Accuracy: ± 3.0 (+ 2.5% of setting) cmH ₂ O, measured at patient wye (end inspiratory pressure after 1 second) when Rise Time Percent is 100% New patient value: 15 cmH ₂ O Depends on: PEEP, $\uparrow P_{PEAK}$

Table A-13: Ventilator settings (cont)

Setting	Function	Range, resolution, accuracy
<p>Inspiratory time (T_I)</p>	<p>Sets the duration of inspiration during pressure control (PC or VC+) mandatory breaths. Not settable in VC, but T_I is displayed on breath timing bar and changes based upon changes to VC settings.</p>	<p>Range: 0.20 to 8.00 seconds T_{IH} 0.2 s to 30 s (BILEVEL mode only)</p> <p>Resolution: 0.01 s when mandatory breath type is PC or VC+; 0.02 s when mandatory breath type is VC</p> <p>Accuracy: ± 0.01 s</p> <p>New patient value: Based on circuit type, IBW, and VC settings</p> <p>Depends on: I:E, f, T_E</p>
<p>Mandatory type</p>	<p>Sets the type of mandatory breath: volume control (VC), pressure control (PC), or volume control plus (VC+). VC+ is only available with INVASIVE Vent type selected and with the <i>Volume Ventilation Plus</i> (VV+) option installed, when the mode is A/C or SIMV.</p>	<p>Range: VC, PC, or VC+</p> <p>Resolution: Not applicable</p> <p>Accuracy: Not applicable</p> <p>New patient value: Neonatal: PC Pediatric/Adult: VC</p>

Table A-13: Ventilator settings (cont)

Setting	Function	Range, resolution, accuracy
Mode	<p>Defines ventilatory mode, which defines the allowable breath types:</p> <p>A/C allows PC (pressure control) or VC (volume control) or VC+ mandatory breaths. When Vent Type is NIV, A/C allows PC or VC mandatory breaths, only.</p> <p>SIMV allows mandatory breaths (PC, VC or VC+) and spontaneous breaths (with or without PS or TC). When Vent Type is NIV, SIMV allows PC or VC mandatory breaths and spontaneous breaths with or without PS.</p> <p>SPONT allows only spontaneous breaths [with or without pressure support (PS), tube compensation (TC), volume support (VS), or proportional assist (PA)], except for manual inspirations, which may be PC or VC mandatory breaths. These same settings are also allowed when Vent Type is NIV, except that TC, VS, and PA are not available.</p> <p>BILEVEL (optional) allows PC mandatory breaths and spontaneous breaths (with or without PS or TC). BILEVEL establishes two levels of positive airway pressure. BILEVEL is not available when Vent Type is NIV.</p> <hr/> <p>NOTE:</p> <p>Ventilator settings unique to the BILEVEL mode are described in the <i>BiLevel</i> option addendum to this manual.</p> <hr/>	<p>Range: A/C, SIMV, SPONT, CPAP (optional), or BILEVEL (optional)</p> <p>Resolution: Not applicable</p> <p>Accuracy: Not applicable</p> <p>New patient value: Neonatal: SIMV Pediatric/Adult: A/C</p>

Table A-13: Ventilator settings (cont)

Setting	Function	Range, resolution, accuracy
O ₂ %	Sets the percentage of oxygen in the delivered gas.	Range: 21 to 100% Resolution: 1% O ₂ Accuracy: ± 3% by volume over the entire breath New patient value: Neonatal: 40% Pediatric/Adult: 100%
	<hr/> <p>NOTE: A significant change to the O₂% setting can cause the V_{TE} (exhaled tidal volume) to be transiently displayed as lower or higher than the actual exhaled volume. This is a result of initial spirometry calculations and does not reflect actual volume exhaled by the patient.</p> <hr/>	
Patient circuit type	Indicates the type of circuit used on the ventilator. Setting can be changed only during SST.	Range: Neonatal, Pediatric, or Adult Neonatal is only available with the <i>NeoMode</i> software option installed Resolution: Not applicable Accuracy: Not applicable
	<hr/> <p>NOTE: To ensure optimum compliance compensation, specify PEDIATRIC patient circuit when patient IBW ≤ 24 kg.</p> <hr/>	

Table A-13: Ventilator settings (cont)

Setting	Function	Range, resolution, accuracy
Peak inspiratory flow (\dot{V}_{MAX})	Sets the peak (maximum) inspiratory flow during VC mandatory breaths.	<p>Range:</p> <p>Neonatal: ≥ 1.0 L/min to ≤ 30 L/min</p> <p>Pediatric: ≥ 3.0L/min to ≤ 60 L/min</p> <p>Adult: ≥ 3.0 L/min to ≤ 150 L/min</p> <p>Resolution:</p> <p>0.1 L/min for flows of 1 to 20 L/min</p> <p>1 L/min for flows of 20 L/min and above</p> <p>Accuracy:</p> <p>$\pm (0.5 + 10\%$ of setting) L/min</p> <p>Body temperature and pressure, saturated (BTSP) after the first 100 ms of inspiration and without compliance compensation</p> <p>New patient value: When circuit type is Adult and flow pattern is Descending Ramp: $2 \times 0.435 \times$ IBW. When flow pattern is Square:$0.435 \times$ IBW. When circuit type is Pediatric and flow pattern is Square: $MAX(0.572 \times$ IBW), 3.0. When flow pattern is Descending Ramp: $2 \times 0.572 \times$ IBW. When circuit type is Neonatal: $MAX (2 \times 0.750 \times$ IBW) 1.0</p> <p>Depends on: Circuit type, IBW, V_T, f, flow pattern, T_{PL}, I:E, T_E</p>

Table A-13: Ventilator settings (cont)

Setting	Function	Range, resolution, accuracy
PEEP	Sets the positive end-expiratory pressure, defined as the positive pressure targeted in the patient circuit during exhalation (also called <i>baseline</i>).	<p>Range: 0 to 45 cmH₂O</p> <p>Resolution: 0.5 cmH₂O for 0 to 19.5 cmH₂O 1 cmH₂O for 20 to 45 cmH₂O</p> <p>Accuracy: ± (2.0 + 4% of setting) cmH₂O measured at patient wye PEEP measured with returned flow: < 5 L/min</p> <p>New patient value: 3 cmH₂O</p> <p>Depends on: $\uparrow P_{PEAK}$, P_I</p>
Plateau time (T _{PL})	Sets the extension of a VC mandatory breath during which gas delivery stops and exhalation is blocked. Increases the residence time of delivered gas in the patient's lungs.	<p>Range: 0.0 to 2.0 seconds</p> <p>Resolution: 0.1 second</p> <p>Accuracy: ±0.01 second</p> <p>New patient value: 0.0 seconds</p> <p>Depends on: V_T, f, flow pattern, \dot{V}_{MAX}, I:E, T_E</p>
Pressure sensitivity (P _{SENS})	Sets the pressure drop below PEEP required to begin a patient-initiated breath (when pressure triggering is selected).	<p>Range: 0.1 to 20 cmH₂O below PEEP</p> <p>Resolution: 0.1 cmH₂O</p> <p>Accuracy: Not applicable</p> <p>New patient value: 2 cmH₂O</p>

Table A-13: Ventilator settings (cont)

Setting	Function	Range, resolution, accuracy
Pressure support (P_{SUPP})	Sets the inspiratory assist pressure (above PEEP) at the patient wye during a spontaneous breath, when spontaneous breath type is pressure support (PS).	<p>Range: 0 to 70 cmH₂O; $P_{SUPP} + PEEP \leq 90$ cmH₂O; $P_{SUPP} + PEEP + 2$ cmH₂O \leq $\uparrow P_{PEAK}$</p> <p>Resolution: 1 cmH₂O</p> <p>Accuracy: $\pm (3.0 + 2.5\%$ of setting) cmH₂O measured at patient wye (end inspiratory pressure after 1 second)</p> <p>New patient value: 0 cmH₂O</p> <p>Depends on: $\uparrow P_{PEAK}$</p>
Respiratory rate (f)	Sets the minimum number of mandatory breaths the patient receives per minute. Active in A/C, SIMV, and BILEVEL.	<p>Range: Neonatal: 1.0 to 150/min Pediatric/Adult: 1.0 to 100/min</p> <p>Resolution: 0.1/min for 1.0 to 10/min 1/min for 10 to 150/min</p> <p>Accuracy: $\pm(0.1 + 0.6\%$ of setting) 1/min averaged over 60 s or 5 breaths, whichever occurs last</p> <p>New patient value: Neonatal: 20/min Pediatric: 14/min Adult: 10/min</p>

Table A-13: Ventilator settings (cont)

Setting	Function	Range, resolution, accuracy
<p>Rise time percent</p> 	<p>Sets how quickly inspiratory pressure rises to achieve the set (target) inspiratory pressure in pressure control (PC) or pressure support (PS) breaths. A higher value means the target pressure is reached more quickly.</p> <hr/> <p>Warning</p> <p>Under certain clinical circumstances, for example, stiff lungs or high airway resistance, a rise time percent > 50% could cause a transient pressure overshoot and premature transition to exhalation. Carefully evaluate the patient's condition before setting the rise time percent above the default setting of 50%.</p>	<p>Range: 1 to 100% Resolution: 1% Accuracy: Not applicable New patient value: 50%</p>
<p>Safety ventilation (safe state)</p>	<p>A safe mode of ventilation becomes active if you connect the patient circuit before you complete ventilator startup. (You cannot modify the default safety ventilation settings.)</p> <p>Safety ventilation annunciates a high-urgency PROCEDURE ERROR alarm and sets these alarm limits:</p> <ul style="list-style-type: none"> High circuit pressure = 20 cmH₂O Low exhaled minute volume = 0.05 L <p>All other alarms are inactive.</p>	<p>Safety ventilation settings include:</p> <ul style="list-style-type: none"> Mode = A/C Mandatory type = PC Respiratory rate = 16/min Inspiratory time = 1 second Inspiratory pressure = 10 cmH₂O PEEP = 3 cmH₂O Trigger type = pressure Pressure sensitivity = 2 cmH₂O Rise time percent = 50% O₂% = 100% or 40% in NeoMode (21% if O₂ not available)

Table A-13: Ventilator settings (cont)

Setting	Function	Range, resolution, accuracy
Spontaneous type	<p>Sets the type of spontaneous breath: not pressure supported (NONE), pressure supported (PS), Tube Compensated (TC), Volume Supported (VS), or Proportionally Assisted (PA). TC is only available with the <i>Tube Compensation</i> option when the patient circuit type is pediatric or adult. PA is only available with the <i>PAV+</i> option when the circuit type is adult, IBW \geq 25.0 kg, and tube I.D. \geq 6.0 mm. VS is only available with the <i>Volume Ventilation Plus</i> option.</p>	<p>Range: When Vent Type is INVASIVE: Neonatal: PS, NONE, VS Pediatric: NONE, PS, TC, VS Adult: NONE, PS, TC, VS, PA When Vent Type is NIV: Neonatal/Pediatric/Adult: PS, NONE Resolution: Not applicable Accuracy: Not applicable New patient value: PS</p>

Table A-13: Ventilator settings (cont)

Setting	Function	Range, resolution, accuracy
<p>Tidal volume (for VC) or Target volume (for VC+) (V_T)</p>	<p>Sets the volume of gas delivered to the patient's lungs during a mandatory volume-based breath.</p> <p>Tidal volume is compensated for body temperature and pressure, saturated (BTPS) and the compliance of the patient circuit.</p>	<p>Range:</p> <p>Neonatal: 2 mL to 315 mL*</p> <p>Pediatric/Adult: 25 mL to 2500 mL (IBW-based range is 1.16 x IBW minimum; 45.7 x IBW maximum)</p> <p>Resolution:</p> <p>0.1 mL for 2 to 5 mL*</p> <p>1 mL for 5 to 100 mL</p> <p>5 mL for 100 to 400 mL</p> <p>10 mL for 400 to 2500 mL</p> <p>Accuracy:</p> <p>Compliance- and BTPS-compensated:</p> <p>For $T_I < 600$ ms: ± 10 mL (+ 10% x (600 ms/T_I) of setting)</p> <p>For $T_I > 600$ ms: ± 10 mL (+10% of setting)</p> <p>New patient value:</p> <p>Neonatal: MAX(2 mL, (7.25 * IBW)); when circuit type = NEONATAL and Mandatory Type = VC+*</p> <p>MAX (3 mL, (7.25 * IBW)); when circuit type = NEONATAL and Mandatory Type = VC*</p> <p>Pediatric/Adult: (7.25 X IBW)</p> <p>Depends on: Circuit type, IBW, f, VMAX, flow pattern, TPL, I:E, TE</p> <p>*Assumes NeoMode 2.0 software option is installed</p>

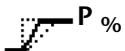
Table A-13: Ventilator settings (cont)

Setting	Function	Range, resolution, accuracy
Trigger type	Determines whether flow or pressure triggers patient breaths. See also flow sensitivity and pressure sensitivity.	Range: Neonatal: Flow (\dot{V} -TRIG) Pediatric/Adult: INVASIVE Vent Type: Pressure (P-TRIG) or Flow (\dot{V} -TRIG) NIV Vent Type: Flow (\dot{V} -TRIG) Resolution: Not applicable Accuracy: Not applicable New patient value: Flow (\dot{V} -TRIG)
Vent Type	Allows user to select invasive or non-invasive ventilation type based upon the type of breathing interface used. INVASIVE: ET or Trach tubes NIV: masks, infant nasal prongs, or uncuffed ET tubes.	Range: INVASIVE or NIV (non-invasive) Resolution: Not applicable Accuracy: Not applicable New patient value: INVASIVE

Table A-14: Alarm settings

Setting	Function	Range and resolution
Apnea interval (T_A)	Sets the maximum time from the start of one inspiration to the start of the next inspiration, after which the ventilator enters apnea ventilation. Press the APNEA button to change the T_A setting.	Range: MAX (10 s, 60/ Apnea f) seconds Resolution: 1 second New patient value: Neonatal: 10 seconds Pediatric: 15 seconds Adult: 20 seconds
High circuit pressure limit ($\uparrow P_{PEAK}$)	Sets the maximum circuit pressure (relative to ambient) allowed during inspiration. When the high circuit pressure limit is reached during inspiration, the ventilator halts inspiration and begins exhalation.	Range: 7 to 100 cmH ₂ O Resolution: 1 cmH ₂ O New patient value: Neonatal: 30 cmH ₂ O Pediatric/Adult: 40 cmH ₂ O
O ₂ sensor	Enabling the O ₂ sensor will allow the High/Low delivered O ₂ % alarm to function. This alarm indicates the O ₂ % measured during any phase of a breath cycle is higher or lower than the internally programmed limits. The alarm limits are automatically adjusted during 100% O ₂ suction, apnea ventilation, patient circuit disconnect, low pressure gas inlet, and when the O ₂ % setting is changed.	Range: O ₂ sensor Enabled, Disabled, or Calibration New patient value: Enabled NOTE: Alarm only occurs if O ₂ sensor is Enabled.

Table A-14: Alarm settings (cont)

Setting	Function	Range and resolution
High exhaled minute volume limit ($\uparrow \dot{V}_{E\text{TOT}}$)	Sets the maximum exhaled minute volume limit for spontaneous or mandatory breaths.	<p>Range: OFF</p> <p><i>or</i></p> <p>≥ 0.10 L/min and $>$ low exhaled minute volume limit</p> <p><i>and</i></p> <p>Neonatal: ≤ 10 L/min Pediatric: ≤ 30 L/min Adult: ≤ 100 L/min</p> <p>Resolution: 0.005 L for 0.100 to 0.495 L 0.05 L for 0.50 to 4.95 L 0.5 L for 5.0 to 100.0 L</p> <p>New patient value: Neonatal: $[(20 \times 0.001 \text{ L/mL} \times (7.25 \text{ mL/kg} \times \text{IBW}) \times 1.30) + 0.05]$ Pediatric: $[(14 \times 0.001 \text{ L/mL} \times (7.25 \text{ mL/kg} \times \text{IBW}) \times 1.30) + 0.05]$ Adult: $[(10 \times 0.001 \text{ L/mL} \times (7.25 \text{ mL/kg} \times \text{IBW}) \times 1.30) + 0.05]$</p>

Table A-14: Alarm settings (cont)

Setting	Function	Range and resolution
High exhaled tidal volume limit ($\uparrow V_{TE}$)	Sets the maximum exhaled tidal volume limit for spontaneous or mandatory breaths.	Range: OFF <i>or</i> > low exhaled spontaneous tidal volume limit > low exhaled mandatory tidal volume limit <i>and</i> Neonatal: 5 mL to 500 mL Pediatric: 25 mL to 1500 mL Adult: 25 mL to 3000 mL Resolution: 1 mL for 5 mL to 100 mL 5 mL for 100 to 400 mL 10 mL for 400 to 3000 mL New patient value: MAX [(7.25 mL/kg x IBW x 1.30), 5] mL
High respiratory rate limit ($\uparrow f_{TOT}$)	Sets the maximum breath rate limit.	Range: OFF <i>or</i> Neonatal: 10/min to 170/min Pediatric/Adult: 10/min to 110/min Resolution: 1/min New patient value: OFF

Table A-14: Alarm settings (cont)

Setting	Function	Range and resolution
Low exhaled mandatory tidal volume limit ($\downarrow V_{TE\ MAND}$)	Sets the minimum exhaled mandatory tidal volume limit.	Range: OFF or ≥ 1 mL < high exhaled tidal volume limit and Neonatal: ≤ 300 mL Pediatric: ≤ 1000 mL Adult: ≤ 2500 mL Resolution: 1 mL for 1 to 100 mL 5 mL for 100 to 400 mL 10 mL for 400 to 2500 mL New patient value (INVASIVE Vent Type): (7.25 mL/kg x IBW x 0.70) New patient value (NIV Vent Type): OFF

Table A-14: Alarm settings (cont)

Setting	Function	Range and resolution
Low exhaled minute volume limit ($\downarrow \dot{V}_{E\text{TOT}}$)	Sets the minimum exhaled minute volume limit for mandatory and spontaneous breath types.	Range: OFF or < high exhaled minute volume limit <i>and</i> Neonatal: OFF or 0.010 L/min to 10 L/min Pediatric: 0.05 L/min to 30 L/min Adult: 0.05 L/min to 60 L/min Resolution: 0.005 L/min for 0.010 to 0.495 L/min 0.05 L/min for 0.05 to 4.95 L/min 0.5 L/min for 5.0 L to 60.0 L/min New patient value (INVASIVE Vent Type): Neonatal: MAX [(20 x 0.001 L/mL x (7.25 mL/kg x IBW) x 0.70) - 0.05], 0.01] Pediatric: [(14 x 0.001 L/mL x (7.25 mL/kg x IBW) x 0.70) - 0.05] Adult: [(10 x 0.001 L/mL x (7.25 mL/kg x IBW) x 0.70) - 0.05] New patient value (NIV Vent Type): OFF

Table A-14: Alarm settings (cont)

Setting	Function	Range and resolution
Low exhaled spontaneous tidal volume limit ($\downarrow V_{TE\ SPONT}$)	Sets the minimum exhaled spontaneous tidal volume limit.	Range: OFF <i>or</i> ≥ 1 mL $<$ high exhaled tidal volume limit <i>and</i> Neonatal: ≤ 300 mL Pediatric: ≤ 1000 mL Adult: ≤ 2500 mL Resolution: 1 mL for 1 to 100 mL 5 mL for 100 to 400 mL 10 mL for 400 to 2500 mL New patient value (INVASIVE Vent type): ($7.25 \text{ mL/kg} \times \text{IBW} \times 0.70$) New patient value (NIV Vent Type or when Spontaneous Type is PA): OFF
Low circuit pressure alarm limit ($\downarrow P_{PEAK}$)	Sets the minimum allowable circuit pressure. Available only during NIV or when VC+ is selected as Mandatory Type in INVASIVE ventilation.	Range: NIV: OFF to $\uparrow P_{PEAK} - 1 \text{ cmH}_2\text{O}$ VC+: PEEP to $\uparrow P_{PEAK} - 1 \text{ cmH}_2\text{O}$ <hr/> NOTE: When VC+ is selected, $\downarrow P_{PEAK}$ can be set to OFF only if PEEP is set to 0. <hr/> New patient value: PEEP + 6 cmH ₂ O Resolution: 0.5 cmH ₂ O for pressures $<$ 20 cmH ₂ O 1 cmH ₂ O for pressures \geq 20 cmH ₂ O

Table A-15: Patient data

Parameter	Function	Range, resolution, accuracy
Breath type	<p>Indicates the type of breath and its delivery phase, either inspiratory or expiratory. The background is light during inspiration, dark during exhalation.</p> <p>This display stays on throughout the entire breath cycle, and is updated at the beginning of each inspiration and exhalation. The breath indicator display is not synchronized with the exhaled tidal volume (V_{TE}) display, which applies to the previous breath cycle.</p>	<p>Type: Control (C), assist (A), or spontaneous (S)</p> <p>Phase: Inspiration or exhalation</p> <p>Resolution: Not applicable</p> <p>Accuracy: Not applicable</p>
Delivered O ₂ % (O ₂ %)	<p>Indicates the percentage of oxygen in the gas delivered to the patient, measured at the ventilator outlet upstream of the inspiratory filter. The high and low O₂% alarms are set internally and are based on the set O₂% value.</p>	<p>Range: 0 to 103%</p> <p>Resolution: 1% O₂</p> <p>Accuracy: ± 3% O₂ of full scale</p>
End expiratory pressure (PEEP)	<p>Indicates the pressure at the end of the expiratory phase of the previous breath. Updated at the beginning of the next inspiration. If expiratory pause is active, the displayed value reflects the level of any active lung PEEP.</p>	<p>Range: -20.0 to 130 cmH₂O</p> <p>Resolution:</p> <ul style="list-style-type: none"> 0.1 cmH₂O for -20.0 to 9.9 cmH₂O 1 cmH₂O for 10 to 130 cmH₂O <p>Accuracy:</p> <p>± (2 + 4% of reading) cmH₂O relative to the pressure measured at the exhalation side of the patient wye</p>

Table A-15: Patient data (cont)

Parameter	Function	Range, resolution, accuracy
End inspiratory pressure ($P_{I\text{ END}}$)	Indicates the pressure at the end of the inspiratory phase of the current breath. Updated at the beginning of the exhalation phase. If plateau is active, the displayed value reflects the level of end-plateau pressure.	Range: -20.0 to 130 cmH ₂ O Resolution: 0.1 cmH ₂ O for -20.0 to 9.9 cmH ₂ O 1 cmH ₂ O for 10 to 130 cmH ₂ O Accuracy: ± (2 + 4% of reading) cmH ₂ O relative to the patient wye for pressure control breaths with inspiratory times of 1 second or longer
Exhaled minute volume ($\dot{V}_{E\text{ TOT}}$)	Displays a calculated total of the volumes exhaled by the patient for mandatory and spontaneous breaths for the previous one-minute interval. The displayed value is compliance- and BTPS-compensated. Exhaled minute volume updates at the beginning of the next inspiration.	Range: 0.00 to 99.9 L Resolution: 0.01 L for 0.00 to 9.99 L 0.1 L for 10.0 to 99.9 L Accuracy: For $T_E < 600$ ms: ± 10 x respiratory rate (+ 10% x (600 ms/ T_E) of reading) mL For $T_E > 600$ ms: ± 10 x respiratory rate (+ 10% of reading) mL

Table A-15: Patient data (cont)

Parameter	Function	Range, resolution, accuracy
<p>Exhaled tidal volume (V_{TE})</p>	<p>Indicates the volume exhaled by the patient for the previous mandatory or spontaneous breath. The displayed value is compliance- and BTPS-compensated. Exhaled tidal volume updates at the beginning of the next inspiration.</p>	<p>Range: 0 to 6000 mL Resolution: 0.1 mL for 0.0 to 9.9 mL 1 mL for 10 to 6000 mL Accuracy: For $T_I < 600$ ms: $\pm (10 + 10\% (600 \text{ ms}/T_E) \text{ of setting})$ mL For $T_I > 600$ ms: $\pm (10 + 10\% \text{ of setting})$ mL Compliance- and BTPS-compensated T_E = time to exhale 90% of exhaled volume</p>
	<p>NOTE: A significant change to the $O_2\%$ setting can cause the V_{TE} (exhaled tidal volume) to be transiently displayed as lower or higher than the actual exhaled volume. This is a result of initial spirometry calculations and does not reflect actual volume exhaled by the patient.</p>	
<p>I:E ratio</p>	<p>Indicates the ratio of inspiratory time to expiratory time for the previous breath, regardless of type. Updated at the beginning of the next inspiration. Due to limitations in setting the I:E ratio in PC ventilation, the monitored data display and the setting may not match precisely.</p>	<p>Range: 1:599 to 149:1 Resolution: 0.1 for 1:9.9 to 9.9:1 1 for 1:599 to 1:10 and 10:1 to 149:1 Accuracy: $\pm 1\%$</p>

Table A-15: Patient data (cont)

Parameter	Function	Range, resolution, accuracy
Intrinsic PEEP (PEEP _I)	Indicates a calculated estimate of the pressure above the PEEP level at the end of exhalation. Determined during an expiratory pause maneuver.	Range: -20.0 to 130 cmH ₂ O Resolution: 0.1 cmH ₂ O for -20.0 to 9.9 cmH ₂ O 1 cmH ₂ O for 10 to 130 cmH ₂ O
Peak circuit pressure (P _{PEAK})	Indicates the maximum pressure during the previous breath, relative to the patient wye, including the inspiratory and expiratory phases. Updated at the end of inspiration.	Range: -20.0 to 130 cmH ₂ O Resolution: 0.1 cmH ₂ O for -20.0 to 9.9 cmH ₂ O 1 cmH ₂ O for 10 to 130 cmH ₂ O
Mean circuit pressure (P _{MEAN})	Indicates the average circuit pressure over the previous one-minute interval, regardless of type. Updated at the beginning of the next inspiration.	Range: -20.0 to 130 cmH ₂ O Resolution: 0.1 cmH ₂ O for -20.0 to 9.9 cmH ₂ O 1 cmH ₂ O for 10 to 130 cmH ₂ O Accuracy: ± (3 + 4% of reading) cmH ₂ O
Plateau pressure (P _{PL})	Displays the pressure in the ventilator breathing circuit at the end of an inspiratory pause maneuver. An estimate of the pressure in the patient's lungs. P _{PL} updates continuously.	Range: -20.0 to 130 cmH ₂ O Resolution: 0.1 cmH ₂ O for -20.0 to 9.9 cmH ₂ O 1 cmH ₂ O for 10 to 130 cmH ₂ O Accuracy: ± (2 + 4% of reading) cmH ₂ O

Table A-15: Patient data (cont)

Parameter	Function	Range, resolution, accuracy
Rapid shallow breathing index (f/V_T)	Displays the ratio of respiratory rate to inspired volume measurements on the MORE PATIENT DATA screen. Available for spontaneous breaths (SPONT mode) only. Accessible during normal ventilation by touching the MORE PATIENT DATA button on the upper GUI screen.	Range: 0.0 to 600 1/min-L Resolution: 0.1 for $f/V_T < 10$ 1/min-L 1 for $f/V_T \geq 10$ 1/min-L Accuracy: Not applicable
Spontaneous inspiratory time ($T_{I \text{ SPONT}}$)	Displays the measured patient inspiratory time on the MORE PATIENT DATA screen. Available for spontaneous breaths only. Accessible during normal ventilation by pressing the MORE PATIENT DATA button on the upper GUI screen.	Range: 0.00 to 10.00 s Resolution: 0.01 s Accuracy: Not applicable
Spontaneous minute volume ($V_{E \text{ SPONT}}$)	Displays a calculated total of the volumes exhaled by the patient for spontaneous breaths for the previous one-minute interval. Values for mandatory breaths during this period are not included. The displayed value is compliance- and BTPS-compensated. Updated at the beginning of the next inspiration.	Range: 0.00 to 99.9 L Resolution: 0.01 L for 0.00 to 9.99 L 0.1 L for 10.0 to 99.9 L Accuracy: For $T_E < 600$ ms: $\pm [10 \times \text{respiratory rate} + 10\% (600 \text{ ms}/T_E) \text{ of reading}] \text{ mL}$ For $T_E > 600$ ms: $\pm (10 \times \text{respiratory rate} + 10\% \text{ of reading}) \text{ mL}$

Table A-15: Patient data (cont)

Parameter	Function	Range, resolution, accuracy
Spontaneous percent inspiratory time (T_I/T_{TOT})	Displays the ratio of the inspiratory time to total breath cycle time measurements on the MORE PATIENT DATA screen. Available for spontaneous breaths (SPONT mode) only. Accessible during normal ventilation by pressing the MORE PATIENT DATA button on the upper screen.	Range: 0.00 to 1.00 Resolution: 0.01
Static compliance (C_{STAT})	Displays an estimate of the elasticity of the patient's lungs.	Range: 0 to 500 mL/cmH ₂ O Resolution: 0.1 mL/cmH ₂ O for 0 to 9.9 mL/cmH ₂ O 1 mL/cmH ₂ O for 10 to 500 mL/cmH ₂ O Accuracy: ± (1 + 20%) of actual value mL/cmH ₂ O for 1 to 100 mL/cmH ₂ O
Static resistance (R_{STAT})	Displays an estimate of restrictiveness of the patient's airway.	Range: 0 to 500 cmH ₂ O/L/s Resolution: 0.1 cmH ₂ O/L/s for 0 to 9.9 cmH ₂ O/L/s 1 cmH ₂ O/L/s for 10 to 500 cmH ₂ O/L/s Accuracy: ± (3 + 20%) of actual value cmH ₂ O/L/s (Does not apply if $C_{STAT} < 5$ mL/cmH ₂ O or $\dot{V}_{MAX} < 20$ L/min)

Table A-15: Patient data (cont)

Parameter	Function	Range, resolution, accuracy
Total PEEP (PEEP _{TOT})	Displays the pressure during an expiratory pause maneuver. It is an estimate of the total pressure at the end of exhalation, referenced to atmosphere.	Range: -20.0 to 130 cmH ₂ O Resolution: 0.1 cmH ₂ O for -20.0 to 9.9 cmH ₂ O 1 cmH ₂ O for 10 to 130 cmH ₂ O
Total respiratory rate (f _{TOT})	Displays a calculated value of the number of mandatory and spontaneous breaths delivered to the patient for the previous one-minute interval. f _{TOT} updates at the beginning of the next inspiration.	Range: 0 to 200/min Resolution: 0.1/min for 0.0 to 9.9/min 1/min for 10 to 200/min Accuracy: ± 0.8/min

Table A-16: Other Screens — displayed data

Data displayed	Function
In Service Mode, touch the button at the bottom of the upper GUI screen, or during normal ventilation, touch the Other Screens button at the bottom of the upper GUI screen to reveal the following buttons for other displayed data:	
Diagnostic codes	Information to assist qualified service personnel to troubleshoot the ventilator.
Operational time	Displays operational times for the ventilator and compressor. Use this information to schedule operator maintenance procedures and preventative maintenance conducted by qualified service personnel. The accuracy of reported operational times is ± 2% over 10,000 hours.
SST Results	Displays results from each test performed during the most recent SST.

Table A-16: Other Screens — displayed data (cont)

Data displayed	Function
Ventilator configuration	Displays the GUI and BDU serial numbers and software revision levels, compressor serial number, SAAS firmware revision level, and installed software options. Upgrades or modifications change the software revision level information.
Test summary	Displays overall outcomes for most recently performed SST and EST.

Part numbers

This appendix lists user-replaceable 840 ventilator parts and accessories. Figure B-1 shows Puritan Bennett™ 840 Ventilator System parts corresponding to the part numbers listed in Table B-1. Figure B-2 shows the same accessories mounted on the ventilator (Puritan Bennett 800 Series Ventilator Compressor Mount Cart shown). Table B-2 lists those ventilator parts and accessories. Figure B-3 shows the ventilator mounted on the Puritan Bennett 800 Series Ventilator Pole Cart, and Table B-3 lists the parts and accessories.

NOTE: Accessories listed in Table B-1 (except for the wall air water trap and humidifier mounting kit) and Table B-2 may be ordered for ventilators mounted on Puritan Bennett 800 Series Ventilator Pole Carts. Table B-2 and Table B-3 contain part numbers for humidifier, wall air water trap, and cylinder mounting kits used with ventilators mounted on the Puritan Bennett 800 Series Ventilator Compressor Mount Cart and the Puritan Bennett 800 Series Ventilator Pole Cart.

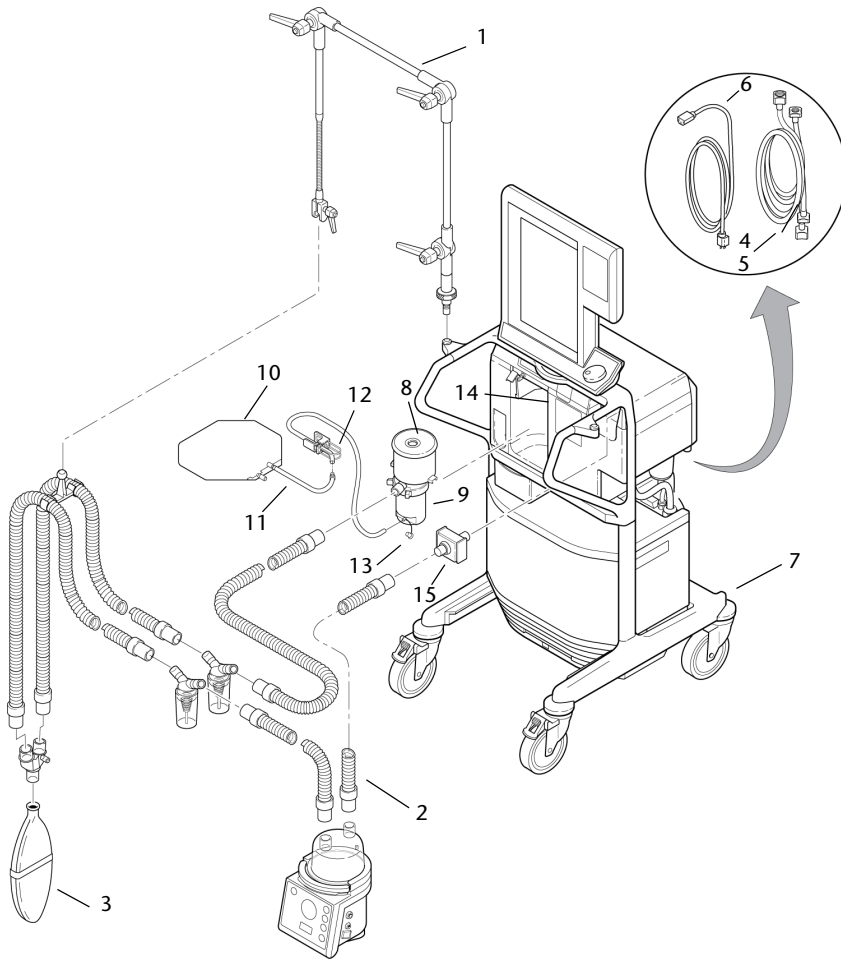

VEN_10754_A

Figure B-1. Ventilator accessories

Table B-1: Ventilator parts and accessories

Item number	Description	Part number
1	Flex arm assembly	4-032006-00
2	Ventilator breathing circuit, adult, reusable. Includes: Tube, adult, 120-cm (2 included) Tube, adult, 40-cm (2 included) Tube, adult, 15-cm (2 included) Wye, adult, with temperature port Water trap, in-circuit (2 included) Adapter, 22-mm male x 22-mm male Tube hanger Wye, adult, reusable	G-061208-SP G-061213-00
	Ventilator breathing circuit, adult, reusable, with heated wire, for use with Fisher & Paykel humidifiers*. Includes: Tube, adult, 15-cm (2 included) Tube, adult, 150-cm (2 included) Wye, adult, with temperature port Adapter, 22-mm male x 22-mm male Tube hanger Adapter, hose heater Temperature probe, dual-airway Heater wire, inspiratory limb Heater wire, expiratory limb Draw wire, 1.5-m	G-061235-00

* Not shown in Figure B-1

Table B-1: Ventilator parts and accessories (cont)

Item number	Description	Part number
2 (cont)	Ventilator breathing circuit, pediatric, reusable.* Includes: Tube, pediatric, 120-cm (2 included) Tube, pediatric, 40-cm (2 included) Tube, pediatric, 15-cm (2 included) Wye, pediatric, straight Water trap, in-circuit (2 included) Adapter, 22-mm male/15-mm female, with temperature port Adapter, 22-mm male/15-mm female (2 included) Tube hanger Adapter, 15-mm male x 15-mm male Adapter, 22-mm male/15-mm female x 22-mm male/15-mm female	G-061223-00
	Ventilator breathing circuit, pediatric, reusable, with heated wire, for Fisher & Paykel humidifiers.* Includes: Tube, pediatric, 15-cm (2 included) Tube, pediatric, 150-cm (2 included) Wye, pediatric, straight Adapter, 15-mm male x 15-mm male Adapter, 22-mm male/15-mm female x 22-mm male/15-mm female Tube hanger Adapter, hose heater Temperature probe, dual-airway Heater wire, inspiratory limb Heater wire, expiratory limb Draw wire, 1.5-m Adapter, 22-mm male/15-mm female, with temperature port Adapter, 22-mm male/15-mm female (2 included)	G-061237-00

* Not shown in Figure B-1

Table B-1: Ventilator parts and accessories (cont)

Item number	Description	Part number
2 (cont)	Ventilator breathing circuit, adult, disposable* Includes: Trach elbow Patient wye w/o port Tube connector Ventilator tube, 72 in. (183 cm) Rubber cuff, ventilator tube Wye port cap Protective cap Tube hanger	6-003030-00
3	Test lung	4-000612-00
4	Hose assembly, oxygen, DISS, for USA	4-001474-00
5	Hose assembly, air, for USA (DISS)	4-006541-00
6	Power cord, North America	4-071420-00
7	RTA Cart, ventilator	4-076102-00
8	Expiratory bacteria filter, 22-mm ISO connectors, with collector vial, single-patient use (<i>D/X800</i> , carton of 12)	4-076887-00
9	Collector vial, reusable (<i>Re/X800</i> , each)	4-074647-00
10	Drain bag, single-patient use (package of 25)	4-048491-00
11	Tubing, drain bag, single-patient use (package of 10)	4-048493-00
12	Clamp, reusable (carton of 5)	4-048492-00
13	Drain cap	4-074613-00
14	Seal, expiratory filter	4-070311-00

* Not shown in Figure B-1

Table B-1: Ventilator parts and accessories (cont)

Item number	Description	Part number
15	Inspiratory bacteria filter, 22-mm ISO connectors, disposable (<i>D/Flex</i> , carton of 12)	4-074601-00
	Inspiratory bacteria filter, 22-mm ISO connectors, reusable (<i>Re/Flex</i> , each)	4-074600-00
	Wall Air Water Trap kit, cart-mount, DISS male (Includes water trap, bracket with mounting hardware, and interconnect hose)*	4-075315-00
	Mounting kit, Fisher & Paykel 480/730 humidifier*	4-075313-00
	Mounting kit, Hudson RCI ConchaTherm humidifier (Includes only parts that allow humidifier to be plugged into ventilator. Contact Hudson RCI to obtain brackets to install humidifier to ventilator cart.)*	4-075312-00
	Operator's manual, US English*	4-075609-00
	Service manual, English*	4-070496-00
	Oxygen sensor (To be replaced every year or as necessary. See Section 7.4.6.1 on page OP 7-17.)*	4-072214-00
	Filter, compressor inlet*	4-074374-00
	Test (gold standard) hose, 21 inches (53 cm) (for use with EST)*	4-018506-00
	Cable assembly, GUI-to-BDU extension, 10 ft*	4-071441-00
	Mask assembly, large (for Non-invasive ventilation)*	4-005253-00

* Not shown in Figure B-1

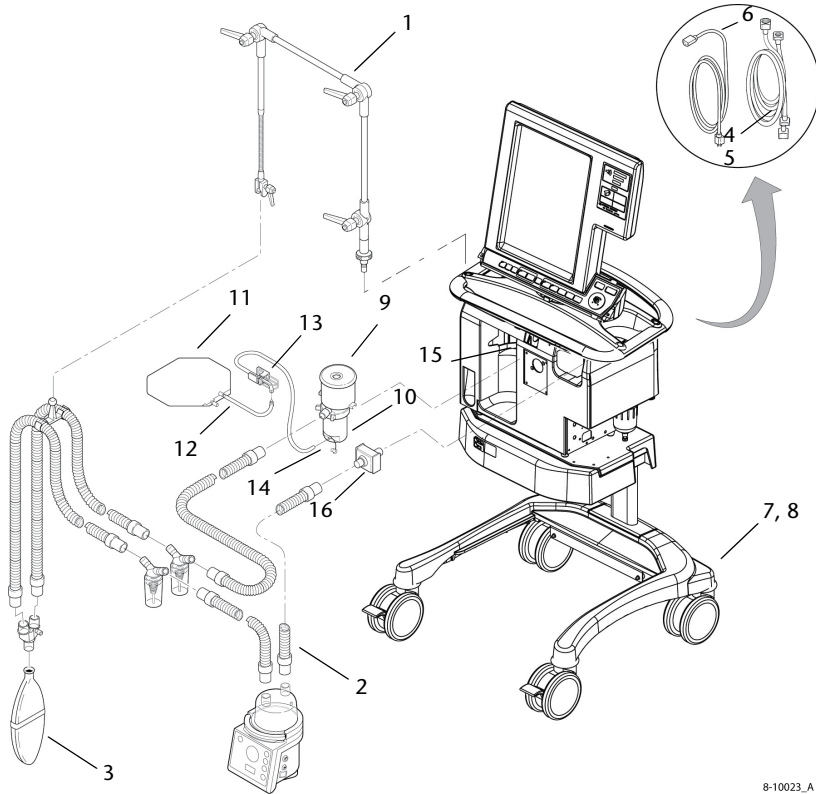

8-10023_A

Figure B-2. Ventilator accessories (Puritan Bennett 800 Series Ventilator Compressor Mount Cart shown)

Table B-2: Ventilator parts and accessories

Item number	Description	Part number
1	Flex arm assembly	4-032006-00
2	Ventilator breathing circuit, adult, reusable. Includes: Tube, adult, 120-cm (2 included) Tube, adult, 40-cm (2 included) Tube, adult, 15-cm (2 included) Wye, adult, with temperature port Water trap, in-circuit (2 included) Adapter, 22-mm male x 22-mm male Tube hanger Wye, adult, reusable	G-061208-SP G-061213-00
	Ventilator breathing circuit, adult, reusable, with heated wire, for use with Fisher & Paykel humidifiers*. Includes: Tube, adult, 15-cm (2 included) Tube, adult, 150-cm (2 included) Wye, adult, with temperature port Adapter, 22-mm male x 22-mm male Tube hanger Adapter, hose heater Temperature probe, dual-airway Heater wire, inspiratory limb Heater wire, expiratory limb Draw wire, 1.5-m	G-061235-00

* Not shown in Figure B-2

Table B-2: Ventilator parts and accessories (cont)

Item number	Description	Part number
2 (cont)	Ventilator breathing circuit, pediatric, reusable.* Includes: Tube, pediatric, 120-cm (2 included) Tube, pediatric, 40-cm (2 included) Tube, pediatric, 15-cm (2 included) Wye, pediatric, straight Water trap, in-circuit (2 included) Adapter, 22-mm male/15-mm female, with temperature port Adapter, 22-mm male/15-mm female (2 included) Tube hanger Adapter, 15-mm male x 15-mm male Adapter, 22-mm male/15-mm female x 22-mm male/15-mm female	G-061223-00
	Ventilator breathing circuit, pediatric, reusable, with heated wire, for Fisher & Paykel humidifiers.* Includes: Tube, pediatric, 15-cm (2 included) Tube, pediatric, 150-cm (2 included) Wye, pediatric, straight Adapter, 15-mm male x 15-mm male Adapter, 22-mm male/15-mm female x 22-mm male/15-mm female Tube hanger Adapter, hose heater Temperature probe, dual-airway Heater wire, inspiratory limb Heater wire, expiratory limb Draw wire, 1.5-m Adapter, 22-mm male/15-mm female, with temperature port Adapter, 22-mm male/15-mm female (2 included)	G-061237-00

* Not shown in Figure B-2

Table B-2: Ventilator parts and accessories (cont)

Item number	Description	Part number
2 (cont)	Ventilator breathing circuit, adult, disposable* Includes: Trach elbow Patient wye w/o port Tube connector Ventilator tube, 72 in. (183 cm) Rubber cuff, ventilator tube Wye port cap Protective cap Tube hanger	6-003030-00
3	Test lung	4-000612-00
4	Hose assembly, oxygen, DISS, for USA	4-001474-00
5	Hose assembly, air, for USA (DISS)	4-006541-00
6	Power cord, North America	4-071420-00
7	Puritan Bennett 800 Series Ventilator Compressor Mount Cart with one-hour battery	10046822
8	Puritan Bennett 800 Series Ventilator Compressor Mount Cart with four-hour battery	10046823
9	Expiratory bacteria filter, 22-mm ISO connectors, with collector vial, single-patient use (<i>D/X800</i> , carton of 12)	4-076887-00
10	Collector vial, reusable (<i>Re/X800</i> , each)	4-074647-00
11	Drain bag, single-patient use (package of 25)	4-048491-00
12	Tubing, drain bag, single-patient use (package of 10)	4-048493-00
13	Clamp, reusable (carton of 5)	4-048492-00
14	Drain cap	4-074613-00
15	Seal, expiratory filter	4-070311-00

* Not shown in Figure B-2

Table B-2: Ventilator parts and accessories (cont)

Item number	Description	Part number
16	Inspiratory bacteria filter, 22-mm ISO connectors, disposable (<i>D/Flex</i> , carton of 12)	4-074601-00
	Inspiratory bacteria filter, 22-mm ISO connectors, reusable (<i>Re/Flex</i> , each)	4-074600-00
	Wall Air Water Trap kit*	10045588
	Humidifier Mounting kit*	10045589
	Cylinder Mounting kit*	10045586
	Operator’s manual, US English*	4-075609-00
	Service manual, English*	4-070496-00
	Oxygen sensor (To be replaced every year or as necessary. See Section 7.4.6.1 on page OP 7-17)*	4-072214-00
	Filter, compressor inlet*	4-074374-00
	Test (gold standard) hose, 21 inches (53 cm) (for use with EST)*	4-018506-00
	Cable assembly, GUI-to-BDU extension, 10 ft*	4-071441-00
	Mask assembly, large (for Non-invasive ventilation)*	4-005253-00

* Not shown in Figure B-2

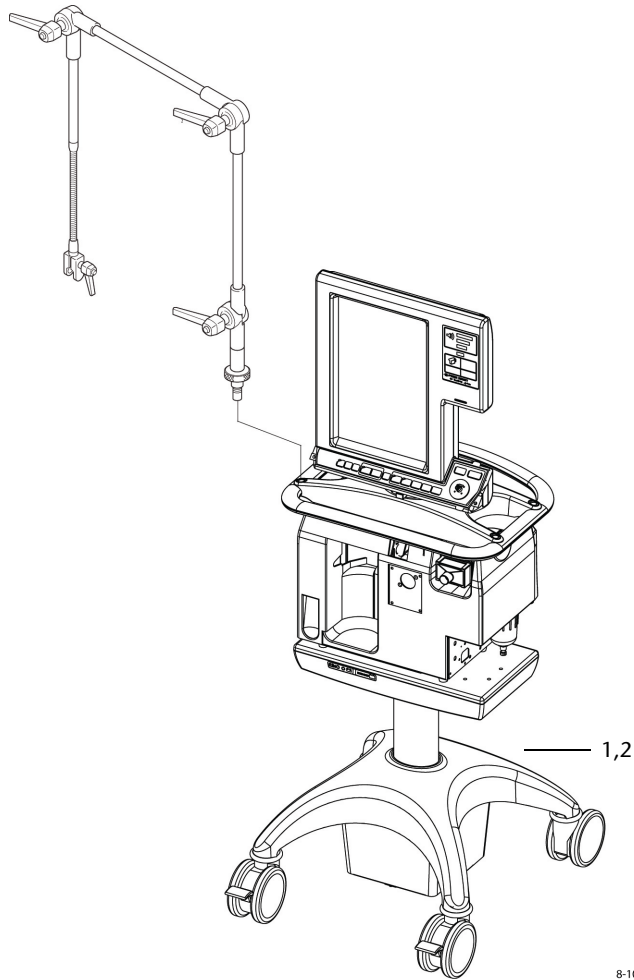

8-10021_A

Figure B-3. Puritan Bennett 840 Ventilator System shown mounted on Puritan Bennett 800 Series Ventilator Pole Cart

Table B-3: Ventilator Pole cart and accessories

Item number	Description	Part number
1	Puritan Bennet 800 Series Ventilator Pole Cart with one-hour battery	10046826
2	Puritan Bennet 800 Series Ventilator Pole Cart with four-hour battery	10046827
	Kit, humidifier mounting*	10042364
	Kit, cylinder mounting*	10045578
	Kit, wall air water trap*	10045588

* Not shown in Figure B-3

This page is intentionally blank.

Pneumatic schematic

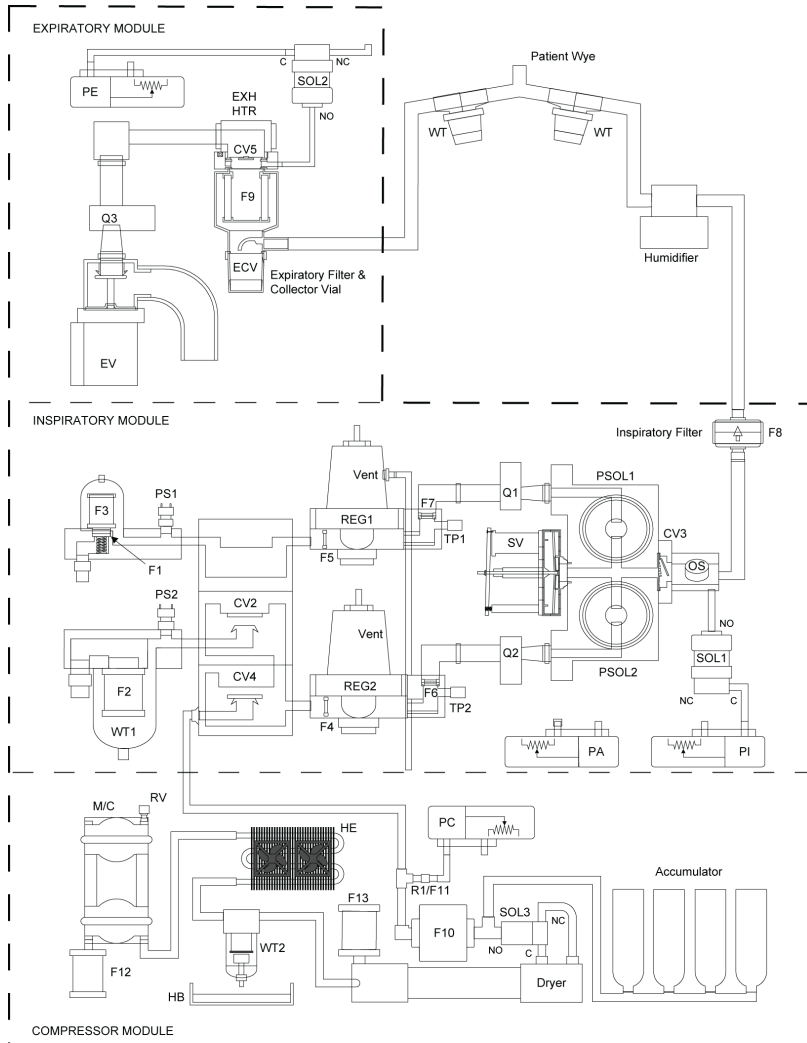

VEN_10755_A

Figure C-1. Pneumatic schematic

This page is intentionally blank.

Alarm and oxygen sensor calibration testing

Test the alarms and the oxygen sensor calibration as required, using the procedures below.

NOTE:

When performing the alarm tests, use a ventilator configured for use with an adult patient circuit.

D.1 Alarm test

Alarm tests require an oxygen and air source and stable AC facility power. High and low delivered O₂ alarm testing requires a length of adult disposable flex tubing and a length of low-pressure oxygen supply tubing with an oxygen connector on one end. If any alarm does not annunciate as indicated, verify ventilator setup, ventilator settings, and repeat the alarm test. Alarm testing checks the operation of the following alarms:

- CIRCUIT DISCONNECT
- LOW EXHALED MANDATORY TIDAL VOLUME ($\downarrow V_{TE\ MAND}$)
- LOW EXHALED TOTAL MINUTE VOLUME ($\downarrow \dot{V}_{E\ TOT}$)
- HIGH VENTILATOR PRESSURE ($\uparrow P_{VENT}$)
- HIGH CIRCUIT PRESSURE ($\uparrow P_{PEAK}$)
- SEVERE OCCLUSION
- AC POWER LOSS
- APNEA
- LOW EXHALED SPONTANEOUS TIDAL VOLUME ($\downarrow V_{TE\ SPONT}$)
- NO O₂ SUPPLY
- LOW DELIVERED O₂% ($\downarrow O_2\%$)
- HIGH DELIVERED O₂% ($\uparrow O_2\%$)

- 1 Disconnect patient circuit from ventilator and turn off ventilator for at least 5 minutes.
- 2 Turn the ventilator on. Ventilator automatically runs power on self test (POST).
- 3 In the GUI lower subscreen, select NEW PATIENT.
- 4 Set up new patient as follows:
 - IBW:** 70 kg
 - Vent Type:** INVASIVE
 - Mode:** A/C
 - Mandatory Type:** VC
 - Trigger Type:** \dot{V} -TRIG
- 5 Set new patient settings as follows:
 - f:** 6/min
 - V_T :** 500 mL
 - \dot{V}_{MAX} :** 30 L/min
 - T_{PL} :** 0 seconds
 - Flow pattern:** SQUARE
 - \dot{V}_{SENS} :** 3 L/min
 - O_2 :** 21%
 - PEEP:** 5 cmH₂O
- 6 Set apnea settings as follows:
 - T_A :** 10 seconds
 - f:** 6.0/min
 - O_2 :** 21%
 - V_T :** 500 mL

- 7 Set alarm settings as follows:
 - \bar{P}_{PEAK} : 70 cmH₂O
 - f_{TOT} : OFF
 - $\downarrow\dot{V}_{\text{E TOT}}$: 1 L/min, $\bar{V}_{\text{E TOT}}$: 3.5 L/min
 - $\downarrow V_{\text{TE MAND}}$: 300 mL, $\bar{V}_{\text{TE MAND}}$: OFF
 - $\downarrow V_{\text{TE SPONT}}$: OFF, $\bar{V}_{\text{TE SPONT}}$: OFF
- 8 Set the graphics display to a Volume-Time plot (for use in APNEA alarm test).
- 9 Connect an adult patient circuit to the ventilator and attach a test lung (P/N 4-000612-00) to the patient wye.

NOTE:

To ensure proper test results, do not touch the test lung or patient circuit during the next three steps.

10 CIRCUIT DISCONNECT alarm test:

Allow the ventilator to deliver at least four breaths. During the inspiratory phase of a breath, disconnect the inspiratory filter from the *To patient* port.

The ventilator annunciates a CIRCUIT DISCONNECT alarm after the inspiratory filter is disconnected.

Connect the inspiratory filter to the *To patient* port.

11 LOW EXHALED MANDATORY TIDAL VOLUME alarm test:

Set V_T to 200 mL.

The ventilator annunciates a LOW EXHALED MANDATORY TIDAL VOLUME ($\downarrow V_{\text{TE MAND}}$) alarm on the third consecutive breath after ACCEPT is pressed.

Press the alarm reset key to reset the alarm.

12 LOW EXHALED TOTAL MINUTE VOLUME alarm test:

Set $\downarrow\dot{V}_{\text{E TOT}}$ alarm limit to 3.45 L/min.

The ventilator annunciates a LOW EXHALED TOTAL MINUTE VOLUME alarm on the next breath after ACCEPT is pressed.

13 HIGH VENTILATOR PRESSURE alarm test:

Set patient and alarm settings as follows:

V_T : 1000 mL

\dot{V}_{MAX} : 100 L/min

$\uparrow P_{PEAK}$: 100 cmH₂O

$\downarrow \dot{V}_{E\ TOTAL}$: 0.050 L/min, $\uparrow \dot{V}_{E\ TOTAL}$: OFF

$\downarrow V_{TE\ MAND}$: OFF

Allow the ventilator to deliver at least four breaths.

Remove the test lung and block the wye.

The GUI annunciates a HIGH VENTILATOR PRESSURE alarm ($\uparrow P_{VENT}$) during the first breath after blocking the wye.

Unblock the wye and attach the test lung to the patient wye. The alarm autoresets (may take several breaths to autoreset).

14 HIGH CIRCUIT PRESSURE alarm test:

Set patient and alarm settings as follows:

\dot{V}_{MAX} : 30 L/min

$\uparrow P_{PEAK}$: 20 cmH₂O

After one breath, the ventilator annunciates a HIGH CIRCUIT PRESSURE alarm ($\uparrow P_{PEAK}$). If alarm does not sound, check the patient circuit for leaks.

15 SEVERE OCCLUSION alarm test:

Set patient and alarm settings as follows:

V_T : 500 mL

$\uparrow P_{PEAK}$: 50 cmH₂O

Press the alarm reset key to reset all alarms.

Slowly pinch the patient circuit expiratory limb at any point until the GUI annunciates a SEVERE OCCLUSION alarm.

While you maintain the occlusion, ensure the safety valve open indicator lights, the upper screen shows the elapsed time without normal ventilation support, and the test lung inflates periodically as the ventilator delivers pressure-based breaths.

Release the expiratory limb. The ventilator should return to normal ventilation within three breaths. Press the alarm reset key to reset all alarms.

16 AC POWER LOSS alarm test: Allow the ventilator to deliver at least four breaths, press the alarm reset key to reset all alarms, then disconnect the power cord from AC facility power.

If the BPS is charged, the GUI annunciates an AC POWER LOSS alarm. If less than 2 minutes of battery backup are available, the GUI annunciates a LOW BATTERY alarm. If a BPS is not installed, the BDU annunciates a LOSS OF POWER alarm.

Connect the power cord to AC facility power. The AC POWER LOSS, LOW BATTERY, or LOSS OF POWER alarm autoresets.

17 APNEA alarm test:

Set up patient and alarm settings as follows:

$\uparrow P_{PEAK}$: 70 cmH₂O

Mode: SPONT

Spontaneous Type: PS

NOTE:

To avoid triggering a breath during the apnea interval, do not touch the test lung or patient circuit.

The GUI annunciates an APNEA alarm within 10 seconds after pressing ACCEPT.

Squeeze the test lung twice to simulate two subsequent patient-initiated breaths. The APNEA alarm autoresets.

NOTE:

The exhaled tidal volume (V_{TE}) displayed in the monitored patient data area must be greater than half the delivered volume shown on the Volume-Time plot in the graphics display in order for apnea to autoreset (refer to Technical Reference Chapter 9 for a technical description of apnea ventilation).

Let the ventilator return to apnea ventilation.

18 LOW EXHALED SPONTANEOUS TIDAL VOLUME alarm test:

Set patient and alarm settings as follows:

Trigger type: P_{TRIG}

P_{SENS}: 4.0 cmH₂O

$\downarrow V_{TE SPONT}$: 2500 mL

Press the alarm reset key to reset the apnea alarm.

Slowly squeeze the test lung to simulate spontaneous breaths. The ventilator annunciates a LOW EXHALED SPONTANEOUS

TIDAL VOLUME ALARM at the start of the third consecutive spontaneous inspiration.

Set up patient as follows:

Mode: A/C

$\downarrow V_{TE\ SPONT}$: OFF

Press the alarm reset key to reset the $\downarrow V_{TE\ SPONT}$ alarm.

19 NO O₂ SUPPLY alarm test:

Disconnect the oxygen inlet supply.

The ventilator annunciates a NO O₂ SUPPLY alarm within one breath.

Connect the oxygen inlet supply.

The NO O₂ SUPPLY alarm autoresets within 2 breaths after oxygen is reconnected.

20 LOW DELIVERED O₂% and HIGH DELIVERED O₂% alarm test:

Set patient and alarm settings as follows:

P_{SENS}: 2 cmH₂O

O₂: 100%

Set apnea settings as follows:

T_A: 60 seconds

Replace the inspiratory filter with a 6-inch piece of adult disposable flex tubing with a ¼-inch slit in its side, about 3 inches from the end. Insert a length of low-pressure oxygen supply tubing into the slit and about 1½ inches into the *To patient* port. Attach the other end of the oxygen supply tubing to a known air supply (for example, a medical-grade air cylinder).

Set the flow from the air supply to 1 L/min, and watch the upper GUI screen. The value for O₂ (delivered O₂%) should decrease, and the ventilator should annunciates a $\downarrow O_2\%$ alarm within 30 seconds.

Remove the oxygen supply tubing from the air supply and attach it to a known 100% O₂ source (for example, a medical-

grade oxygen cylinder). Set O₂% to 21%. Set the flow from the oxygen source to 1 L/min, and watch the upper GUI screen. The value for O₂ (delivered O₂%) should increase, and the ventilator should annunciate a ↑O₂% alarm within 30 seconds.

Remove the disposable flex tubing and oxygen supply tubing, replace inspiratory filter and standard patient circuit, then press the alarm reset key to clear all alarms.

D.2 Oxygen sensor calibration test

Test the oxygen sensor calibration as follows:

- 1 Connect the ventilator's oxygen hose to a known 100% O₂ source (for example, a medical-grade oxygen cylinder). Press the 100% O₂/CAL 2 min key or the INCREASE O₂ 2 min key to calibrate the oxygen sensor. Proceed to the next step once the key light turns off.
- 2 Connect the ventilator oxygen hose to another known 100% O₂ source (for example, a second medical-grade oxygen cylinder).
- 3 Set O₂% to each of the following values, and allow one minute after each for the monitored value to stabilize:
 - 21%
 - 40%
 - 90%
- 4 Watch the upper screen to ensure the value for O₂ (delivered O₂%) is within 3% of each setting within one minute of selecting each setting.

Remote alarm and RS-232 ports

Appendix E tells you how to use the Puritan Bennett™ 840 Ventilator System's remote alarm (nurse call) and the three RS-232 communication ports. The remote alarm and RS-232 ports are located on the rear of the GUI.

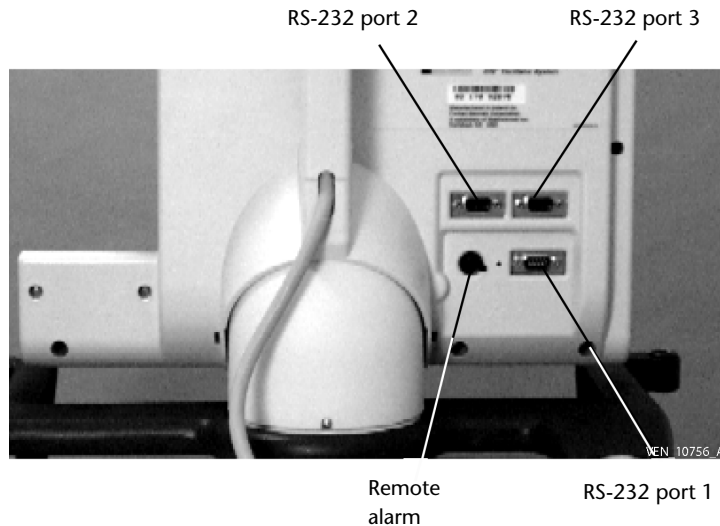

Figure E-1. Remote alarm and RS-232 ports

Warning

To ensure the ventilator is properly grounded and to protect against electrical hazard, always connect the ventilator AC power cord to a grounded wall power outlet (even if the ventilator is operating from the 802 or 803 BPS (Backup Power Source) or Puritan Bennett 800 Series Ventilator battery backup system when the ventilator is connected to an external device via the RS-232 or remote alarm ports.

Caution

To prevent the risk of excessive enclosure leakage current from external equipment connected to the RS-232 and remote alarm ports, a means for external separation of the conductive earth paths must be provided. Refer to the Puritan Bennett 800 Series Ventilator System Service Manual for information and instructions for construction of cable assemblies providing electrical separation, or contact Puritan Bennett for assistance.

E.1 Remote alarm port

The ventilator's remote alarm (nurse call) annunciates medium- and high-urgency alarm conditions at locations away from the ventilator (for example, when the ventilator is in an isolation room). The ventilator signals an alarm using a normally open or a normally closed signal. The ventilator asserts a remote alarm when there is an active medium- or high-urgency alarm condition, unless the alarm silence function is active.

NOTE:

The remote alarm also annunciates when the ventilator power switch is turned off.

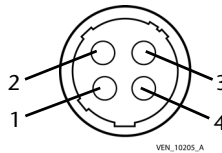

Figure E-2. Remote alarm port pinout (view from back of GUI)

1	Normally closed (NC)
2	Relay common
3	Normally open (NO)
4	Not connected

NOTE:

Allowable current is 100 mA at 12 V DC (minimum) and 500 mA at 30 V DC (maximum).

E.2 RS-232 port

The RS-232 serial ports are 9-pin male connectors configured as data terminal equipment (DTE). Figure E-3 shows the serial port pinout.

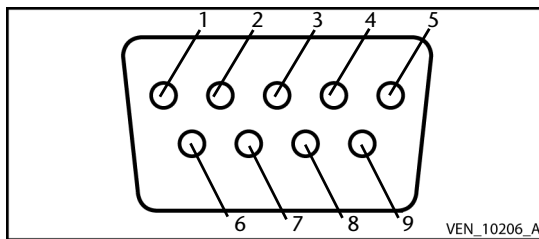

Figure E-3. RS-232 serial port pinout

Pin	Signal
1	Not connected
2	Receive data (RxD)
3	Transmit data (TxD)
4	Data terminal ready (DTR), terminated high
5	Ground (GND)
6	Not connected
7	Request to send (RTS)
8	Clear to send (CTS)
9	Not connected

E.3 How to configure the RS-232 ports

The RS-232 ports must be configured to select the attached device, baud rate, data bits, and parity. Follow these steps to configure the RS-232 ports:

1. From the VENTILATOR SETTINGS screen, press the OTHER SCREENS button.
2. Press the Communications Setup button. The *Current Communication Screen* appears.

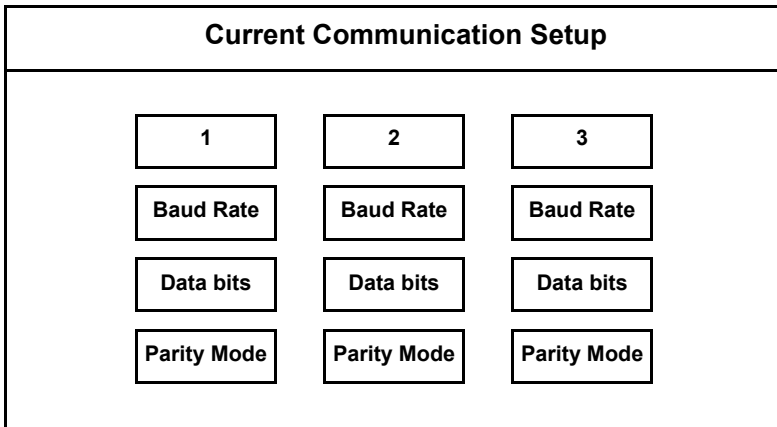

Note: For reference only. Drawing not to scale. Some detail has been omitted for clarity.

3. Touch the button for port 1 then turn the knob to select the attached device (DCI, Printer, SpaceLabs, or Phillips). Choose *DCI* if the attached device is a ventilator monitor or *CliniVision* handheld device, *Printer* for a printer, *SpaceLabs* for a SpaceLabs ventilator monitor, or *Phillips* for Phillips IntelliBridge. If you want to select real-time waveforms, choose either port 2 or 3 and the Waveforms setting.
4. Touch the BAUD RATE button, then turn the knob to select the baud rate (1200, 2400, 4800, 9600, 19200, or 38400). The baud rate will automatically switch to 38400 if you are setting the ventilator for real-time waveforms.
5. Touch the DATA BITS button, then turn the knob to select the data bits (7 or 8).

6. Touch the PARITY MODE button, then turn the knob to select parity (NONE, EVEN, or ODD).

NOTE: The allowable selections for data bits and parity mode are shown here:

Data bits	Parity Mode
7	None, Even, Odd
8	None

7. Press ACCEPT to apply the changes, or press the OTHER SCREENS button to cancel the changes.
8. Real-time waveforms continuously transmits pressure, flow, and sequence numbers in ASCII format from the selected serial port (2 or 3), at a baud rate of 38400 pulses/s, and the operator selected stop bits, and parity. A line of pressure and flow readings is taken every 20 msec. The collection of readings shall be transmitted on the selected serial port at the end of each breath at breath rates of 10/min and higher. For longer duration breaths, at least the first eight seconds of the breath is transmitted. The format of the data is as follows: The beginning of inspiration is indicated by: "BS, S:nnn,<LF>" where 'BS' identifies the Breath Start, 'S:nnn' is a sequence number incremented at every breath, and <LF> is a line feed character. The fff, and ppp fields show the breath flow and pressure data. The end of exhalation is indicated by: "BE<LF>" where 'BE' indicates Breath End, and <LF> is a line feed character. The pressure will be less than the ventilator setting if there is a leak in the test lung or circuit.

E.4 Printers and cables

The following equipment can be used to print graphical displays from the Puritan Bennett 840 Ventilator System:

Printers

RS-232 serial printers using the Hewlett-Packard PCL5 communication protocol can be used with the Puritan Bennett 840 Ventilator System. Printers using the HP PCL5 communication protocol, but with other connector interfaces such as USB or parallel, may be able to be used with the appropriate RS-232 serial converter cable.

Cables

A serial cable (DB9 to DB9 or DB25 connectors) is required to connect to RS-232 serial printers. An RS-232 serial-to-parallel converter cable (DB9 to 36-pin Centronics male connectors) is required for use with a printer connected to a parallel port. An RS-232 serial-to-USB converter cable (DB9 to USB connectors) is needed to use a printer connected via a USB port. These cables must contain electronics to convert the RS-232 signals into the appropriate signals read by parallel or USB printers, and may need to be configured to match the baud rate, parity, and data bits of the printer.

To set up the ventilator, printer, and cable for printing:

- 1 Determine the baud rate, parity, and data bits configuration of the printer you are using. Refer to your printer's Operator's Manual for this information.
- 2 Configure serial port 1 for a printer as in Section E.3 using the same settings as the printer.
- 3 If using a converter cable, configure it to use the same settings as the printer and the Puritan Bennett 840 Ventilator System. Refer to the instructions supplied with your cable.
- 4 With the printer turned OFF, connect the cable to the Puritan Bennett 840 Ventilator System and the printer.
- 5 Turn the printer ON.
- 6 Print the desired graphics display as described in Section 6.6 on page OP 6-7.

E.5 RS-232 port commands

Refer to Technical Reference Chapter 19 for information regarding RS-232 port command protocol.

Introduction to breath delivery

The Puritan Bennett™ 840 Ventilator System delivers and measures exhaled volumes to the specified accuracies when using conventional humidification, heated-wire systems, or heat-moisture exchangers (HMEs). In volume control (VC) ventilation, the ventilator compliance-compensates tidal volumes to ensure the clinician-set tidal volume is delivered to the lung. Regardless of mode and breath type, all expiratory volumes are compliance-compensated. Both inspiratory and expiratory volumes are reported in body temperature and pressure, saturated (BTPS) units.

Oxygen and air connect directly to the breath delivery unit (BDU), supplying gas to each of two proportional solenoid (PSOL) valves. Software controls each valve independently and, according to the operator-set O₂%, mixes the breathing gas as it is delivered. Mixed breathing gas passes by a safety valve, then through a one-way valve, bacteria filter, and humidification device on the way to the patient. Exhaled gas is directed to the exhalation compartment, which includes a collector vial, bacteria filter, a one-way valve, a flow sensor, and an active exhalation valve (“active” means the exhalation valve can open and close in precise increments throughout inspiration and exhalation, allowing the ventilator to deliver breaths aggressively while minimizing pressure overshoots, controlling PEEP, and relieving excess pressures). The ventilator does not normally use the safety valve to regulate pressure.

Rather than measure flow and pressure in the harsh environment of the patient wye, the ventilator uses two flow sensors at the delivery (“To patient”) side of the BDU to deliver and measure inspired flow, and a flow sensor in the exhalation compartment (“From patient”) to measure exhaled flow. Circuit pressure referenced to the wye fitting is measured by two pressure transducers: one in the exhalation compartment, and one in the inspiratory pneumatic system, just downstream of the PSOLs.

For the purposes of calculating patient data (including waveforms), the ventilator uses the inspiratory and expiratory pressure transducers to calculate “wye” pressure. All sensors (including flow, pressure, and temperature sensors) are monitored continuously by background tests to ensure gas delivery and exhalation occur according to ventilator settings.

Detecting and initiating inspiration

To deliver a mandatory or spontaneous breath, the breath delivery unit (BDU) uses the operator settings in conjunction with one of the following triggering strategies to initiate a mandatory or spontaneous breath:

- *Internal triggering:* Patient effort or a clock signal. A clock signal can be based on a ventilator setting (for example, respiratory rate or apnea interval) or breath timing within a mode (for example, in SIMV the ventilator delivers a mandatory breath if the patient doesn't initiate a breath in the early part of a breath interval). A clock signal can also occur during alternate ventilation modes such as apnea ventilation, ventilation during occlusion, and safety ventilation.
- *Operator triggering:* The operator presses MANUAL INSP.

The BDU does not allow a second mandatory inspiration during a mandatory or spontaneous inspiration. To prevent autotriggering and allow a minimum expiratory time, a mandatory breath cannot be delivered during the restricted phase of exhalation. The restricted phase of exhalation is complete when either a) or b) and c) (below) have occurred, or if d) occurs regardless of the conditions described in a) through c):

- a Measured expiratory flow falls to less than 50% of the peak expiratory flow
- b Expiratory flow is less than or equal to 0.5 L/min
- c The first 200 ms of exhalation (regardless of breath type) have elapsed
- d at least 5 seconds of exhalation have elapsed

A mandatory breath can be delivered if a mandatory inspiration is internally time-cycled, regardless of the exhaled flow rate.

2.1 Internally triggered inspiration

The ventilator triggers inspiration internally based on:

- pressure sensitivity
- flow sensitivity
- time-cycling
- other software-generated signals

Mandatory breaths triggered using pressure or flow sensitivity are called *patient-initiated mandatory (PIM)* breaths. The ventilator is designed to prevent autotriggering when pressure sensitivity is greater than 1 cmH₂O, or when flow sensitivity is greater than 1 L/min for neonatal or pediatric patients or 1.5 L/min for adult patients, or 1.5 L/min for neonatal and pediatric patients, and 2.0 L/min for adult patients if using a compressor.

2.1.1 Pressure sensitivity

When pressure triggering (P_{TRIG}) is selected, the ventilator initiates breaths based on the monitored pressure at two locations in the patient circuit: inspiratory pressure (P_I) is monitored inside the inspiratory manifold downstream of the proportional solenoid (PSOL) valves, and expiratory pressure (P_E) is monitored just after the expiratory check valve.

As the patient draws gas from the circuit (event A), airway pressure drops below baseline (Figure 2-1). When airway pressure drops below baseline by the value selected for pressure sensitivity (event B), the ventilator initiates a patient-triggered inspiration. The A-B interval depends on two factors:

- How quickly circuit pressure declines (that is, the aggressiveness of the inspiratory effort). The more aggressive the inspiratory effort, the shorter the A-B interval.
- The pressure sensitivity (P_{SENS}) setting. The smaller the setting, the shorter the A-B interval. (The minimum P_{SENS} setting is limited by autotriggering, and the triggering criteria include filtering algorithms that minimize the probability of autotriggering.)

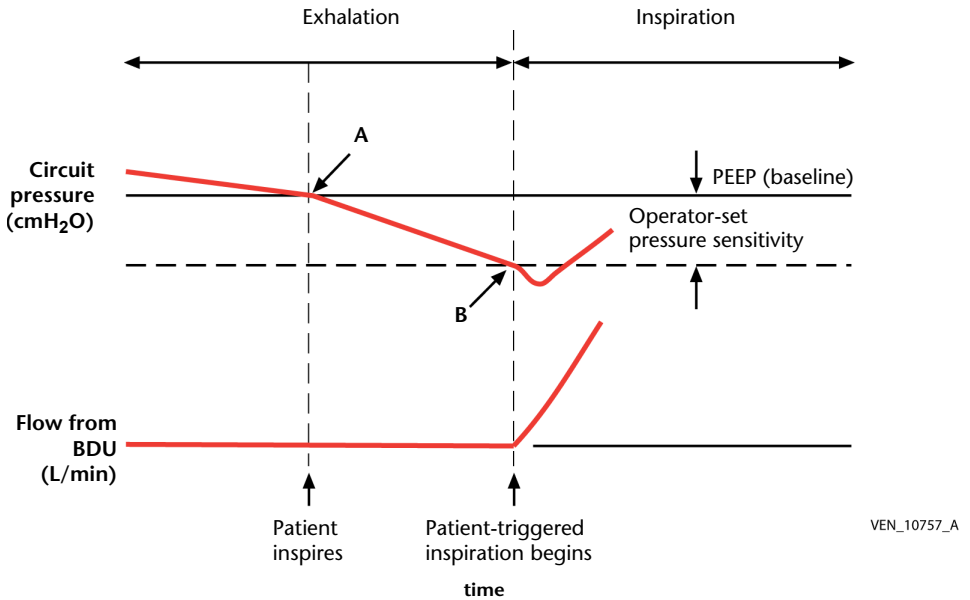

Figure 2-1. Declaring inspiration using pressure sensitivity

2.1.2 Flow sensitivity

When flow triggering (\dot{V} -TRIG) is selected, the BDU maintains a constant flow of gas through the patient circuit (called *base flow*) during the latter part of exhalation. The value of this base flow is 1.5 L/min greater than the operator-selected value for flow sensitivity (state A), shown in Figure 2-2.

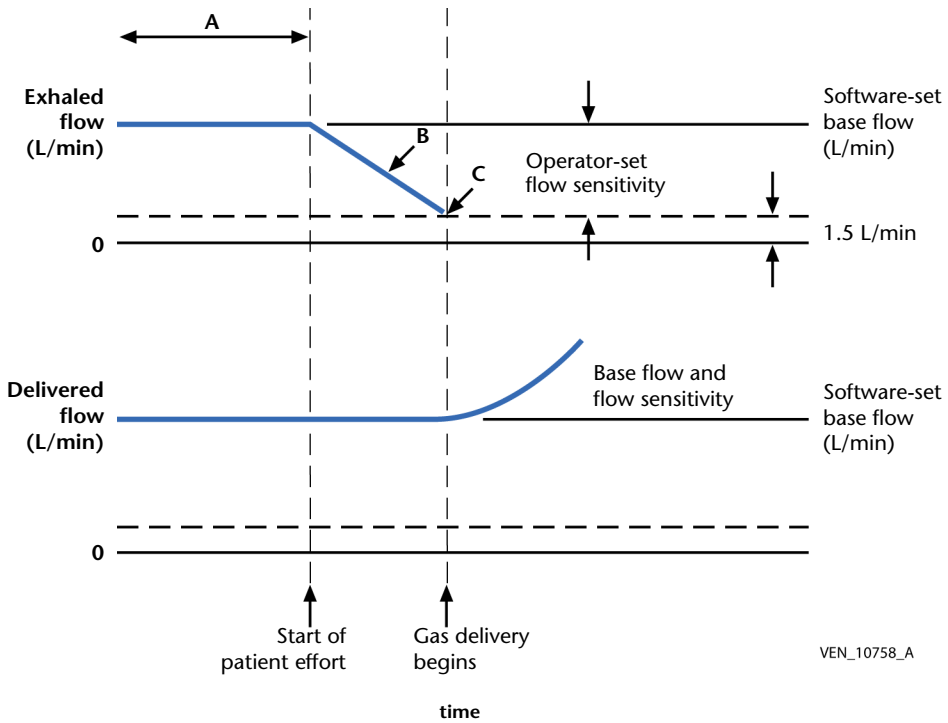

Figure 2-2. Declaring inspiration using flow sensitivity

The ventilator’s inspiratory flow sensors measure the delivered flow, and the expiratory flow sensor measures the exhaled flow. The ventilator indirectly measures patient flow (assuming minimal leaks) by monitoring the difference between the two flow measurements. If the patient is not inspiring, any difference between the delivered and exhaled flow is due to sensor inaccuracy or leaks in the patient system. To compensate for leaks in the patient system, the operator can increase the flow sensitivity, which ideally equals desired flow sensitivity + leak flow.

As the patient inspires from the base flow, the ventilator measures less exhaled flow (event B), while delivered flow remains constant. As the patient continues to inspire, the difference between the two flows measured by the inspiratory and expiratory transducers increases.

The ventilator declares an inspiration when the flow inspired by the patient (that is, the difference between the measured flows) is equal to or greater than the operator-selected value for flow sensitivity (event C). As with pressure triggering, the delay between the start of patient effort and gas delivery depends on two factors:

- How quickly exhaled flow declines (that is, the aggressiveness of the inspiratory effort). The more aggressive the inspiratory effort, the shorter the interval.
- The flow sensitivity (\dot{V}_{SENS}) setting. The smaller the setting, the shorter the interval.

When *flow triggering* is selected, the patient experiences flow during the interval between the start of patient effort and the beginning of gas delivery. When *pressure triggering* is selected, the patient experiences an isometric effort during this interval.

As a backup method of triggering inspiration, a pressure sensitivity of 2 cmH₂O is also in effect. This setting is the most sensitive setting still large enough to avoid autotriggering, yet triggers with acceptable patient effort.

2.1.3 Time-cycled inspiration

The ventilator monitors time intervals from a specific event (for example, triggering a PIM or the transition from inspiration to exhalation). During A/C in the absence of patient effort, the ventilator delivers one inspiration at the beginning of every breath period, as shown in Figure 2-3. Such a breath is called a *ventilator-initiated mandatory (VIM)* breath. If the patient's inspiratory efforts generate a pressure or flow trigger before the breath cycle has elapsed, the ventilator delivers a PIM.

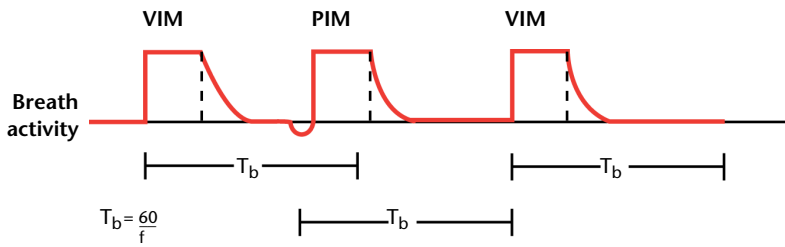

VEN_10759_A

Figure 2-3. Time-cycled inspiration

2.2 Operator-triggered inspiration

Mandatory breaths triggered when the operator presses the MANUAL INSP key are called *operator-initiated mandatory (OIM)* breaths. The ventilator does *not* deliver an OIM during:

- an ongoing inspiration
- the restricted phase of exhalation
- occlusion and disconnect alarm conditions

Detecting and initiating exhalation

The Puritan Bennett™ 840 Ventilator System can declare exhalation based on internal methods or backup limits.

3.1 Internally initiated exhalation

Internal exhalation initiation methods include:

- the *time-cycling method*
- the *end-inspiratory flow method*
- the *airway pressure method*

3.1.1 Time-cycled exhalation

The time-cycling method uses a specified inspiratory time to terminate inspiration and transition to exhalation. The ventilator terminates inspiration based on the set or computed value for inspiratory time. The time-cycling method operates during pressure- and volume-based mandatory breaths.

For pressure-based (including VC+) mandatory breaths, the inspiratory time (T_I) directly defines the length of the inspiratory phase. For volume-based mandatory breaths, the settings for tidal volume, peak flow, flow pattern, and plateau time define the inspiratory time. Compliance compensation increases peak flow as necessary to ensure the set tidal volume is delivered to the patient, in the inspiratory time prescribed.

3.1.2 End-inspiratory flow method

During spontaneous breaths (with or without pressure support), the ventilator preferentially uses measurements of end-inspiratory flow to initiate exhalation. The ventilator monitors delivered flow throughout the inspiratory phase. Regardless of whether the patient begins to exhale, delivered flow decreases due to the decreasing pressure gradient from the patient wye to the alveoli (event A in Figure 3-1). When end-inspiratory flow is equal to or less than $(\text{peak flow} \times E_{\text{SENS}} \%) / 100$, the ventilator initiates exhalation (event B).

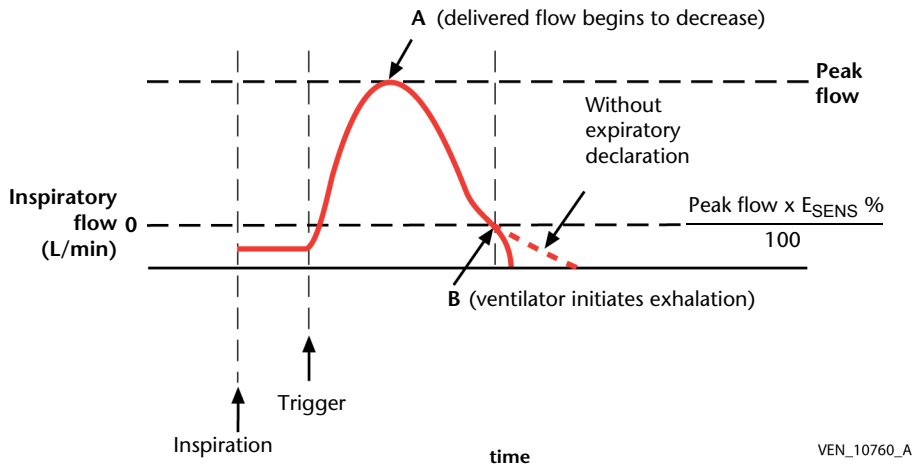

Figure 3-1. Initiating exhalation using the end-inspiratory flow method

3.1.3 Airway pressure method

If expiratory sensitivity (E_{SENS}) is set to a value too low for the patient-ventilator combination, a vigorous expiratory effort could cause circuit pressure (P_{PEAK}) to rise to the pressure cycling threshold. The ventilator monitors circuit pressure throughout the inspiratory phase, and initiates an exhalation when the pressure equals the inspiratory pressure target value + an incremental value. Figure 3-2 shows an example of an exhalation initiated using the airway pressure method.

NOTE:

The allowable incremental value above the target pressure is 1.5 cmH₂O once a portion of inspiration time (T_n) has elapsed. Before T_n , the incremental value is higher to allow for transient pressure overshoots. For the first 200 ms of inspiration, the incremental pressure is 10% of the target pressure, up to a maximum of 8 cmH₂O. From 200 ms to T_n , the incremental pressure decreases in a linear fashion from the initial value to 1.5 cmH₂O.

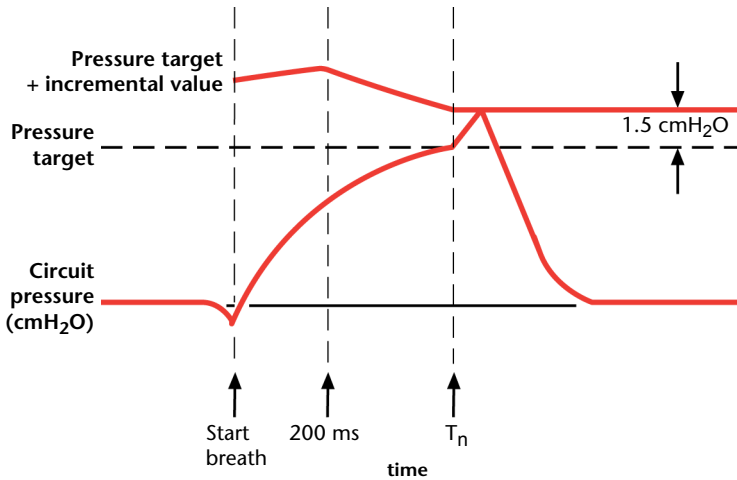

VEN_10761_A

Figure 3-2. Initiating exhalation using the airway pressure method

3.2 Backup limits

In addition to the internal methods of declaring exhalation, backup limits are intended to prevent inspirations of excessive duration or pressure. If a particular breath is subject to more than one backup limit, exhalation is declared by whichever limit is violated first.

3.2.1 Time limit

The time limit applies only to spontaneous breaths, which normally have no inspiratory time limit. If exhalation has not been declared by the time $1.99 + 0.02 \times \text{IBW}$ seconds (adult and pediatric circuit type) or $1.0 + 0.1 \times \text{IBW}$ seconds (neonatal circuit type) of inspiration have elapsed, the ventilator initiates exhalation. When Vent type is NIV, the high spontaneous inspiratory time limit setting ($\uparrow T_{I \text{ SPONT}}$) serves as the time limit for initiating exhalation.

3.2.2 High circuit pressure limit

The high circuit pressure limit applies to all breaths. If the airway pressure equals or exceeds the high circuit pressure limit during any inspiration (except during occlusion status cycling, OSC), the ventilator terminates the inspiration and initiates exhalation.

3.2.3 High ventilator pressure limit

The high ventilator pressure limit applies to volume-based mandatory breaths and spontaneous TC or PA breaths only. If the inspiratory pressure equals or exceeds 100 cmH₂O, the ventilator transitions to exhalation.

Mandatory breath delivery

Chapter 4 describes the following aspects of mandatory breath delivery:

- Pressure- and volume-based mandatory breaths (includes VC+)
- Compliance and body temperature and pressure, saturated (BTPS) compensation for volume-based mandatory breaths
- Manual inspirations

4.1 Comparison of pressure- and volume-based mandatory breaths

Table 4-1 compares pressure- and volume-based breath delivery.

NOTE:

As a general rule, when there are multiple methods of detection, inspiration or exhalation is initiated by the method that declares it first.

Table 4-1: Comparison of pressure- and volume-based mandatory breaths

Characteristic	Pressure-based	Volume-based
Inspiratory detection	Pressure sensitivity, flow sensitivity (including the pressure trigger backup), or time-cycling. Inspiration can also be operator-triggered using MANUAL INSP.	See pressure-based.
Pressure or flow during inspiration	Pressure is targeted to the sum of the operator-selected PEEP + inspiratory pressure. The maximum flow is 200 L/min when using an adult circuit, 80 L/min when using a pediatric circuit, and 30 L/min for neonatal circuits. The wye pressure trajectory depends upon the settings for inspiratory pressure, inspiratory time, and rise time %. The flow-delivery profile is a function of the rise time % setting, the patient's compliance and resistance, and the patient's inspiratory effort (if any). As the rise time % setting is increased from minimum to maximum, the time to achieve the pressure target decreases.	Inspiratory flow trajectories are defined by the settings for tidal volume, peak inspiratory flow, and flow pattern (including compliance compensation). The maximum setting for peak flow is 150 L/min for adult circuit type, 60 L/min for pediatric circuit type, and 30 L/min for neonatal circuit type. Additional flow is available (up to 200 L/min) for compliance compensation.
Exhalation valve during inspiration	Adjusts to minimize pressure overshoot and maintain target pressure.	Closed.
Inspiratory valves during inspiration	Adjust flow to maintain target pressure.	Adjusts to achieve target flow trajectory.

Table 4-1: Comparison of pressure- and volume-based mandatory breaths (cont)

Characteristic	Pressure-based	Volume-based
Expiratory detection	Exhalation is initiated by the time-cycling method. When the time elapsed since the beginning of inspiration equals the inspiratory time (an operator-selected value), the ventilator initiates exhalation. The high pressure limit can also initiate exhalation as a backup strategy.	The operator specifies tidal volume, peak flow, flow pattern, and plateau time, and the ventilator computes an inspiratory time. Exhalation is initiated when the computed inspiratory time has elapsed. The $\uparrow P_{PEAK}$ and $\uparrow P_{VENT}$ alarms can also declare exhalation as a backup strategy.
Pressure or flow during exhalation	Pressure is controlled to PEEP. If flow-triggering is selected, base flow is re-established near the end of expiratory flow. Various strategies operate to minimize autotriggering.	
Inspiratory valve during exhalation	For pressure triggering: near the end of expiratory flow, opens to establish 1 L/min bias flow. For flow triggering: set to deliver base flow.	
Exhalation valve during exhalation	Adjusts to maintain the operator-selected value for PEEP.	

4.2 Compliance compensation for volume-based mandatory breaths

When the ventilator delivers a volume of gas into the patient circuit, not all of the gas actually enters the patient's respiratory system. Part of the delivered volume, called the *compliance volume* (V_C), remains in the patient circuit.

$$V_C = C_{pt\ ckt} (P_{end\ insp} - P_{end\ exh})$$

where:

- $C_{pt\ ckt}$ is the compliance of the patient circuit
- $P_{end\ insp}$ is the pressure at the patient wye at the end of the current inspiration
- $P_{end\ exh}$ is the pressure at the patient wye at the end of the current exhalation

For volume ventilation, practitioners often compute V_C to estimate the loss of volume in the patient circuit, then increase the V_T setting by that amount. Increasing the tidal volume by a single increment to compensate for compliance volume provides only partial compensation, and requires extra effort and understanding on the part of the practitioner. In addition, $P_{\text{end insp}}$ and $P_{\text{end exh}}$ can change with time.

In the Puritan Bennett™ 840 Ventilator System, an iterative algorithm automatically computes the compliance volume. For all flow patterns, compliance compensation does not change inspiratory time (T_I). Compliance compensation is achieved by increasing flow (increasing the amplitude of the flow patterns). Keeping T_I constant maintains the original I:E ratio.

There is a maximum compliance volume to reduce the potential for overinflation due to an erroneous compliance volume calculation. The maximum compliance volume is determined by the selected patient circuit type and ideal body weight (IBW), and is summarized by this equation:

$$V_{\text{comp,max}} = \text{Factor} \times \text{Tidal volume}$$

where:

$V_{\text{comp,max}}$ is the maximum compliance volume

Factor is the linear interpolation of the values in Table 4-2 for adult and pediatric patient circuit types, or for neonatal circuit type:

$$\text{MIN}(10, \text{MAX}(2.5, 1.0 + (2.0/0.3 \times \text{IBW})))$$

For example, let the neonate IBW = 1 kg

1. Calculate $1.0 + (2.0/0.3 \times 1) = 7.67$
2. Compare result with 2.5 and use the maximum value:
 $7.67 > 2.5$
3. Compare result from previous step with 10 and use the minimum value: $7.67 < 10$

Compliance volume factor for a neonatal circuit with IBW = 1 kg is 7.67.

Table 4-2: Compliance volume factors

Adult patient circuit type		Pediatric patient circuit type	
IBW (kg)	Factor	IBW (kg)	Factor
≤ 10	5	≤ 10	5
15	4.6	11	3.5
30	3.4	12.5	2.9
60	2.75	15	2.7
≥ 150	2.5	≥ 30	2.5

4.3 BTPS compensation for volume-based mandatory breaths

The goal of volume ventilation is to deliver a specified volume of gas of known oxygen concentration to the patient's lungs. Since gas volume depends on gas temperature, pressure, and composition, clinicians report and specify tidal volume under the conditions of body temperature (37 °C), existing barometric pressure, and fully saturated with water vapor (100% humidity). This is called *body temperature and pressure, saturated (BTPS)*. All volumes (flows) set or reported by the ventilator are at existing barometric pressure, 37 °C, and fully saturated with water vapor (BTPS). Graphics data is not BTPS-compensated.

4.4 Manual inspiration

A manual inspiration is an operator-initiated mandatory (OIM) inspiration. When the operator presses MANUAL INSP, the ventilator delivers the currently specified mandatory breath (if permitted), either volume- or pressure-based. A volume-based manual inspiration is compliance-compensated.

This page is intentionally blank.

Spontaneous breath delivery

Table 5-1 lists various breath delivery characteristics and how they are implemented during spontaneous breaths (available in SIMV, SPONT, and BILEVEL modes).

NOTE:

As a general rule, when there are multiple methods of detection, inspiration or exhalation is initiated by the method that declares it first.

Table 5-1: Spontaneous breath delivery characteristics

Characteristic	Implementation												
Inspiratory detection	Either pressure or flow sensitivity, whichever is selected.												
Pressure or flow during inspiration Spontaneous type = NONE	Pressure rises according to the selected rise time % and IBW setting, with target pressure 1.5 cmH ₂ O above PEEP to improve work of breathing.												
Pressure or flow during inspiration Spontaneous type = PS $P_{SUPP} < 5 \text{ cmH}_2\text{O}$	Pressure rises according to the selected rise time % and IBW setting, with target pressure equal to the effective pressure + PEEP: <table border="1" style="margin-left: 20px;"> <thead> <tr> <th>P_{SUPP}</th> <th>Effective Pressure (cmH₂O)</th> </tr> </thead> <tbody> <tr> <td>0</td> <td>1.5</td> </tr> <tr> <td>1</td> <td>2.2</td> </tr> <tr> <td>2</td> <td>2.9</td> </tr> <tr> <td>3</td> <td>3.6</td> </tr> <tr> <td>4</td> <td>4.3</td> </tr> </tbody> </table>	P_{SUPP}	Effective Pressure (cmH ₂ O)	0	1.5	1	2.2	2	2.9	3	3.6	4	4.3
P_{SUPP}	Effective Pressure (cmH ₂ O)												
0	1.5												
1	2.2												
2	2.9												
3	3.6												
4	4.3												
Pressure or flow during inspiration Spontaneous type = PS $P_{SUPP} \geq 5 \text{ cmH}_2\text{O}$	Pressure rises according to the selected rise time % and IBW setting, and target pressure equals $P_{SUPP} + \text{PEEP}$.												

Table 5-1: Spontaneous breath delivery characteristics (cont)

Characteristic	Implementation
Inspiratory flow profile	The inspiratory flow profile is determined by patient demand and the rise time % setting. As the rise time % setting is increased from minimum to maximum, the time to achieve the pressure target decreases. The maximum available flow is up to 30 L/min for Neonatal circuit types, 80 L/min for Pediatric circuit types, and up to 200 L/min for Adult circuit types.
Exhalation valve during inspiration	Adjusts to minimize pressure overshoot and maintain the target pressure.
Inspiratory valves during inspiration	Adjust to maintain target pressure. Because the exhalation valve acts as a relief valve venting any excess flow, inspiratory flow can be delivered aggressively and allows improved work of breathing.
Expiratory detection	The end-inspiratory flow or airway pressure method, whichever detects exhalation first. Time backup and the $\uparrow P_{PEAK}$ alarm are also available as backup strategies.
Pressure or flow during exhalation	Pressure is controlled to PEEP. For pressure triggering: set to deliver a bias flow of 1 L/min near the end of expiratory flow. For flow triggering: set to deliver base flow.
Inspiratory valve during exhalation	For pressure triggering: set to deliver a bias flow of 1 L/min near the end of expiratory flow. For flow triggering: set to deliver base flow near the end of expiratory flow.
Exhalation valve during exhalation	Adjusts to maintain the operator-selected value for PEEP.

Assist/control (A/C) mode

In A/C mode, the Puritan Bennett™ 840 Ventilator System delivers only mandatory breaths. When the ventilator detects patient inspiratory effort, it delivers a patient-initiated mandatory (PIM) breath (also called an *assisted* breath). If the ventilator does not detect inspiratory effort, it delivers a ventilator-initiated mandatory (VIM) breath (also called a *control* breath) at an interval based on the set respiratory rate. Breaths can be pressure- or flow-triggered in A/C mode.

6.1 Breath delivery in A/C

In A/C mode, the ventilator calculates the breath period (T_b) as:

$$T_b = 60/f$$

where:

T_b is the breath period in seconds

f is the set respiratory rate in breaths per minute

The length of the inspiratory phase depends on the current breath delivery settings. The ventilator transitions to the expiratory phase at the end of the inspiratory phase. The ventilator calculates the length of the expiratory phase as:

$$T_E = T_b - T_I$$

where:

T_E is the length of the expiratory phase in seconds

T_b is the breath period in seconds

T_I is the length of the inspiratory phase in seconds (including T_{PL} , the plateau time)

Figure 6-1 shows A/C breath delivery when no patient inspiratory effort is detected and all inspirations are VIMs.

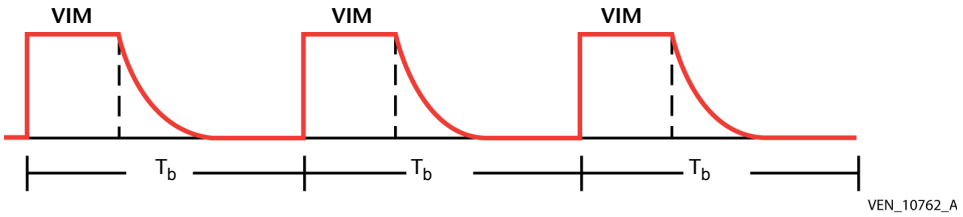

Figure 6-1. A/C mode, no patient effort detected

Figure 6-2 shows A/C breath delivery when patient inspiratory effort is detected. The ventilator delivers PIM breaths at a rate greater than or equal to the set respiratory rate.

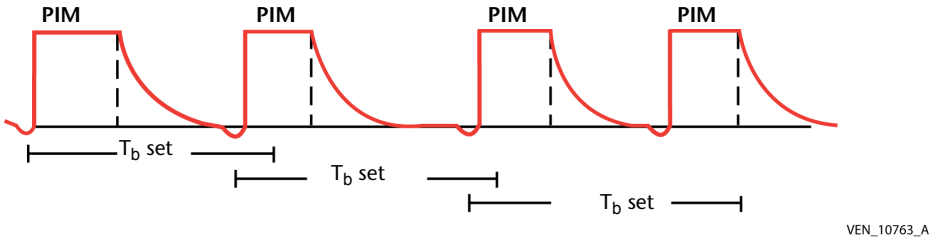

Figure 6-2. A/C mode, patient effort detected

Figure 6-3 shows A/C breath delivery when there is a combination of VIM and PIM breaths.

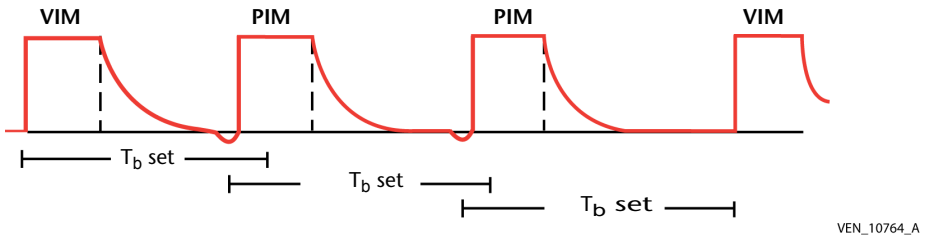

Figure 6-3. A/C mode, VIM and PIM breaths

6.2 Rate change during A/C

Changes to the respiratory rate setting are phased in during exhalation only. The new breath period, based on the new respiratory rate, is based on the start of the current breath, and follows these rules:

- The inspiratory time of current breath is not changed.
- A new inspiration is not delivered until at least 200 ms of exhalation have elapsed.
- The maximum time t until the first VIM for the new respiratory rate will be delivered is 3.5 times the current inspiratory time *or* the length of the new breath cycle (whichever is greater), but t is no longer than the old breath period.
- If the patient generates a PIM after the ventilator recognizes the rate change and before time t , the new rate begins with the PIM.

6.3 Changing to A/C mode

Switching the ventilator to A/C from any other mode causes the ventilator to phase in a VIM and set the start time for the beginning of the next A/C breath cycle. Following this VIM, and before the next A/C cycle begins, the ventilator responds to the patient's inspiratory efforts by delivering mandatory breaths.

The first A/C breath (the VIM breath) is phased in according to these rules:

- The breath is not delivered during an inspiration.
- The breath is not delivered during the restricted phase of exhalation.
- The ventilator ensures the apnea interval elapses at least five seconds after the beginning of exhalation.
- Any other specially scheduled event (such as a respiratory mechanics maneuver or any pause maneuver) is canceled and rescheduled at the next interval.

When the first VIM of the new A/C mode is delivered depends on the mode and breath type active when the mode change is requested.

- If the current mode is SIMV or SPONT and the current or last breath type is spontaneous or an OIM, the time t until the first VIM of the new A/C mode is whichever is less:
 - 3.5 x current inspiratory time, or
 - the length of the apnea interval.
- If the mode is SIMV and the current or last breath is or was mandatory (but not an OIM), the time t until the first VIM of the new A/C mode is whichever is less:
 - 3.5 x current inspiratory time, or
 - the length of the apnea interval, or
 - the length of the current breath cycle.
- If the current mode is BILEVEL in the PEEP_H state and the current breath is mandatory:
 - the PEEP level will be reduced once the exhalation phase is detected.

The time t until the first VIM of the new A/C mode is the lesser of:

- PEEP transition time + 2.5 x duration of the active gas delivery phase, or
 - the length of the apnea interval, or
 - the length of the current breath cycle.
- If the current mode is BILEVEL in the PEEP_H state and the current breath is spontaneous:
 - the PEEP level will be reduced once the exhalation phase is detected.

The time t until the first VIM of the new A/C mode is the lesser of:

- PEEP transition time + 2.5 x duration of the spontaneous inspiration, or
- the start time of the spontaneous breath + the length of the apnea interval.

- If the current mode is BILEVEL in the PEEP_L state and the current breath is mandatory, the time t until the first VIM of the new A/C mode is the lesser of:
 - PEEP transition time + 2.5 x duration of the active gas delivery phase, or
 - the length of the apnea interval, or
 - the length of the current breath cycle.
- If the current mode is BILEVEL in the PEEP_L state and the current breath is spontaneous and the spontaneous start time has occurred during PEEP_L, the time t until the first VIM of the new A/C mode is the lesser of:
 - 3.5 x duration of the spontaneous inspiration, or
 - the length of the apnea interval.
- If the current mode is BILEVEL in the PEEP_L state and the current breath is spontaneous and the spontaneous start time has occurred during PEEP_H, the time t until the first VIM of the new A/C mode is the lesser of:
 - PEEP transition time + 2.5 x duration of the spontaneous inspiration, or
 - the start time of the spontaneous breath + the length of the apnea interval.

This page is intentionally blank.

SIMV is a mixed ventilatory mode allowing both mandatory and spontaneous breaths. The mandatory breaths can be volume- or pressure-based, and the spontaneous breaths can be pressure-assisted (for example, when pressure support is in effect). You can select pressure- or flow-triggering in SIMV.

The SIMV algorithm is designed to guarantee one mandatory breath each SIMV breath cycle. This mandatory breath is either a patient-initiated mandatory (PIM) breath (also called an *assisted* breath) or a ventilator-initiated mandatory (VIM) breath (in case the patient's inspiratory effort is not sensed within the breath cycle).

As Figure 7-1 shows, each SIMV breath cycle (T_b) has two parts: the first part of the cycle is the mandatory interval (T_m) and is reserved for a PIM. If a PIM is delivered, the T_m interval ends and the ventilator switches to the second part of the cycle, the spontaneous interval (T_s), which is reserved for spontaneous breathing throughout the remainder of the breath cycle. At the end of an SIMV breath cycle, the cycle repeats. If a PIM is not delivered, the Puritan Bennett™ 840 Ventilator System delivers a VIM at the end of the mandatory interval, then switches to the spontaneous interval.

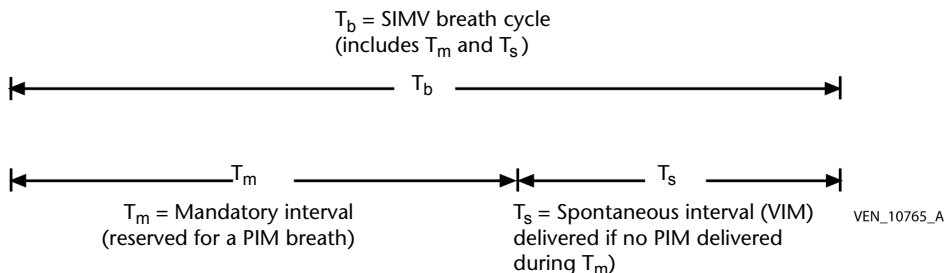

Figure 7-1. SIMV breath cycle (mandatory and spontaneous intervals)

Figure 7-2 shows an SIMV breath cycle where a PIM is delivered within the mandatory interval.

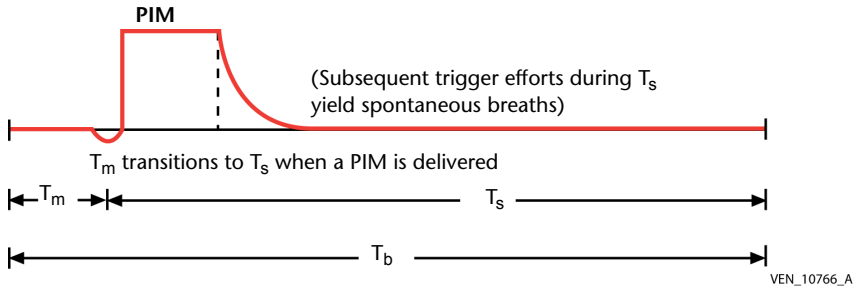

Figure 7-2. SIMV breath cycle, PIM delivered within mandatory interval

Figure 7-3 shows an SIMV breath cycle where a PIM is *not* delivered within the mandatory interval.

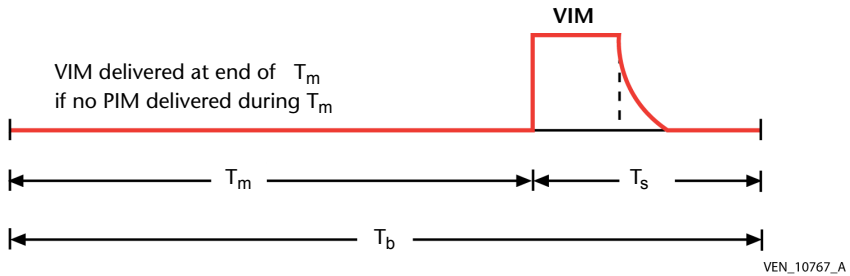

Figure 7-3. SIMV breath cycle, PIM *not* delivered within mandatory interval

7.1 Breath delivery in SIMV

Mandatory breaths in SIMV are identical to mandatory breaths in A/C mode, and spontaneous breaths in SIMV are identical to spontaneous breaths in SPONT mode. Patient triggering must meet the requirements for flow and pressure sensitivity.

The procedure for setting the SIMV respiratory rate is the same as in A/C. Once the respiratory rate (f) is set, the SIMV interval cycle (T_b) in seconds is:

$$T_b = 60/f$$

The SIMV breathing algorithm delivers one mandatory breath each cycle interval, regardless of the patient's ability to breath spontaneously. Once a PIM or VIM is delivered, all successful patient efforts yield spontaneous breaths until the cycle interval ends. The ventilator delivers one mandatory breath during the mandatory interval, regardless of the number of successful patient efforts detected during the spontaneous interval. (An OIM delivered during the mandatory interval satisfies the mandatory breath requirement, and causes T_m to transition to T_s .)

During the mandatory interval, if the patient triggers a breath according to the current setting for pressure or flow sensitivity, the ventilator delivers a PIM. Once a mandatory breath is triggered, T_m ends, T_s begins, and any further trigger efforts yield spontaneous breaths. During the spontaneous interval, the patient can take an unlimited number of spontaneous breaths. If no PIM or OIM is delivered by the end of the mandatory interval, the ventilator delivers a VIM and transitions to the spontaneous interval at the beginning of the VIM.

The maximum mandatory interval for any valid respiratory rate setting in SIMV is defined as whichever is less:

- 0.6 x the SIMV interval cycle (T_b), or
- 10 seconds

In SIMV, the interval from mandatory breath to mandatory breath can be as long as 1.6 x the SIMV cycle interval (but no longer than the cycle interval + 10 seconds). At high respiratory rates and too-large tidal volumes, *breath stacking* (the delivery of a second inspiration before the first exhalation is complete) is inevitable. In volume ventilation, breath stacking during inspiration and early exhalation leads to hyperinflation and increased airway and lung pressures, which can be detected by a high pressure limit alarm. In pressure control ventilation (with inspiratory pressure remaining constant), breath stacking leads to reduced tidal volumes, which can be detected by the low tidal volume and minute ventilation alarms.

If a spontaneous breath occurs toward the end of the spontaneous interval, inspiration or exhalation can still be in progress when the SIMV interval ends. No VIM, PIM, or OIM is allowed during the restricted phase of exhalation. In the extreme, one or more expected mandatory breaths could be omitted. When the expiratory phase of the spontaneous breath ends, the ventilator reverts to its normal criteria for delivering mandatory breaths.

In SIMV mode it is possible for the respiratory rate to drop temporarily below the f setting (unlike A/C mode, in which f_{TOT} is always greater than or equal to the f setting). If the patient triggers a breath at the beginning of a breath cycle, then does not trigger another breath until the maximum mandatory interval for the following breath has elapsed, a monitored respiratory rate less than the respiratory rate setting can result.

7.2 Apnea ventilation in SIMV

The following strategy is designed to allow SIMV to avoid triggering apnea ventilation if a VIM breath can be delivered instead:

- If the apnea interval (T_A) elapses at any time during the mandatory interval, the ventilator delivers a VIM rather than begin apnea ventilation.
- If T_A elapses during the spontaneous interval, apnea ventilation begins.

Figure 7-4 shows how SIMV is designed to deliver a VIM rather than trigger apnea ventilation when possible.

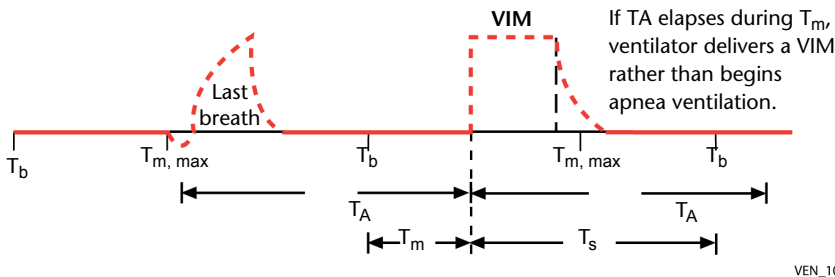

VEN_10768_A

Figure 7-4. Apnea ventilation in SIMV

7.3 Changing to SIMV mode

Switching the ventilator to SIMV from any other mode causes the ventilator to phase in a VIM and set the start time for the next SIMV cycle. Following this VIM, and before the next SIMV cycle begins, the ventilator responds to successful inspiratory efforts by delivering spontaneous breaths. The first SIMV VIM breath is phased in according to these rules:

- The VIM breath is not delivered during an inspiration or during the restricted phase of exhalation.
- If the current mode is A/C, the first SIMV VIM is delivered after the restricted phase of exhalation plus the shortest of the following intervals, referenced to the beginning of the last or current inspiration: $3.5 \times T_I$, current T_A , or the length of the current breath cycle.
- If the current mode is SPONT, and the current or last breath type was spontaneous or OIM, the first SIMV VIM is delivered after the restricted phase of exhalation plus the shortest of the following intervals, referenced to the beginning of the last or current inspiration: $3.5 \times T_I$, or current T_A .
- If the current mode is BILEVEL in the PEEP_H state and the current breath is mandatory:
 - the PEEP level will be reduced once the exhalation phase is detected.

The time t until the first VIM of the new A/C mode is the lesser of:

- PEEP transition time + $2.5 \times$ duration of the active gas delivery phase, or
- the length of the apnea interval, or
- the length of the current breath cycle.

- If the current mode is BILEVEL in the $PEEP_H$ state and the current breath is spontaneous:
 - the PEEP level will be reduced once the exhalation phase is detected.

The time t until the first VIM of the new A/C mode is the lesser of:

- PEEP transition time + 2.5 x duration of the spontaneous inspiration, or
 - the start time of the spontaneous breath + the length of the apnea interval.
- If the current mode is BILEVEL in the $PEEP_L$ state and the current breath is mandatory, the time t until the first VIM of the new A/C mode is the lesser of:
 - PEEP transition time + 2.5 x duration of the active gas delivery phase, or
 - the length of the apnea interval, or
 - the length of the current breath cycle.
 - If the current mode is BILEVEL in the $PEEP_L$ state and the current breath is spontaneous and the spontaneous start time has occurred during $PEEP_L$, the time t until the first VIM of the new A/C mode is the lesser of:
 - 3.5 x duration of the spontaneous inspiration, or
 - the length of the apnea interval.
 - If the current mode is BILEVEL in the $PEEP_L$ state and the current breath is spontaneous and the spontaneous start time has occurred during $PEEP_H$, the time t until the first VIM of the new A/C mode is the lesser of:
 - PEEP transition time + 2.5 x duration of the spontaneous inspiration, or
 - the start time of the spontaneous breath + the length of the apnea interval.

If the command to change to SIMV occurs after the restricted phase of exhalation has ended, and before a next breath or the apnea interval has elapsed, the ventilator delivers the first SIMV VIM the moment the command is recognized.

7.4 Rate change during SIMV

A change to the respiratory rate is phased in during exhalation only. The new SIMV interval is determined by the new respiratory rate and is referenced to the start of the current SIMV cycle interval, following these rules:

- Inspiratory time of current breath is neither truncated nor extended.
- The new inspiration is not delivered until 200 ms of exhalation have elapsed.

The time until the new SIMV interval begins is:

- whichever is greater: the new SIMV cycle interval *or* 3.5 x the last or current T_I ,
- but not greater than the current SIMV cycle interval.

The point at which the new rate is phased in depends on the current phase of the SIMV interval and when the rate change command is accepted. If the rate change occurs during the mandatory interval, the maximum mandatory interval is that for the new or old rate, whichever is less. If the patient generates a successful inspiratory effort during the spontaneous interval, the ventilator responds by giving a spontaneous breath.

This page is intentionally blank.

Spontaneous (SPONT) mode

In spontaneous (SPONT) mode, inspiration is usually initiated by patient effort. Breaths are initiated via pressure- or flow-triggering, whichever is currently active. An operator can also initiate a manual inspiration during SPONT. VIM breaths are not possible in SPONT mode.

8.1 Breath delivery in SPONT

The inspiratory phase begins when the Puritan Bennett™ 840 Ventilator System detects patient effort during exhalation. Unless the breath is an OIM breath, breath delivery during the inspiratory phase is determined by the settings for pressure support, PEEP, rise time %, and expiratory sensitivity.

If Tube Compensation (TC) or Proportional Assist (PA) is selected as the spontaneous type, breath delivery during the inspiratory phase is determined by the settings for % support, expiratory sensitivity, tube I.D., and tube type.

If Volume Support (VS) is selected as the spontaneous type, breath delivery during the inspiratory phase is determined by rise time %, volume support level ($V_{T\ SUPP}$), expiratory sensitivity, and PEEP.

Inspiratory pauses are only possible following OIM breaths, and expiratory pauses are not allowed during SPONT.

8.2 Changing to SPONT mode

If the operator changes to SPONT mode during an A/C or SIMV inspiration (mandatory or spontaneous), the inspiration is completed unaffected by the mode change. Because SPONT mode has no special breath timing requirements, the ventilator then enters the exhalation phase and waits for the detection of patient inspiratory effort, a manual inspiration, or apnea detection.

This page is intentionally blank.

Apnea ventilation

The Puritan Bennett™ 840 Ventilator System's apnea detection strategy follows these rules:

- Apnea is not declared when the apnea interval setting equals or exceeds the breath period. For example, if the respiratory rate setting is 4/min, an apnea interval of 15 seconds or more means apnea cannot be detected.
- The ventilator bases apnea detection on inspiratory (not expiratory) flow, and allows detection of a disconnect or occlusion during apnea ventilation.
- Apnea detection is designed to accommodate interruptions to the typical breathing pattern due to other ventilator features (for example, expiratory pause), but still detect a true apnea event.

9.1 Apnea detection

The ventilator declares apnea when no breath has been delivered by the time the operator-selected apnea interval elapses, plus a small increment of time (350 ms). This increment allows time for a patient who has begun to initiate a breath to trigger inspiration and prevent the ventilator from declaring apnea when the apnea interval is equal to the breath period.

The apnea timer resets whenever an inspiration begins, regardless of whether the inspiration is patient-, ventilator-, or operator-initiated. The ventilator then sets a new apnea interval beginning from the start of the current inspiration. To hold off apnea ventilation, another inspiration must be delivered before (the current apnea interval + 350 ms) elapses. Apnea detection is suspended during a disconnect, occlusion, or safety valve open (SVO) state.

Figure 9-1 shows an apnea interval equal to the breath period.

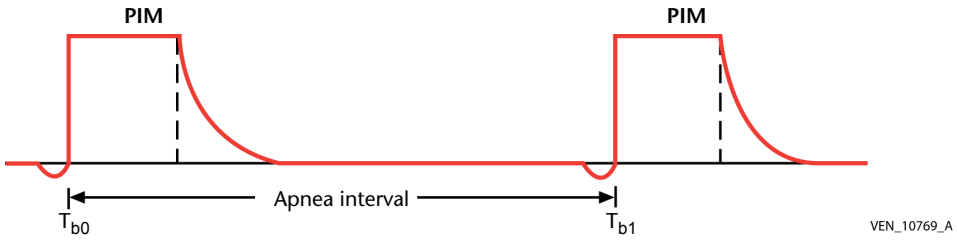

Figure 9-1. Apnea interval equals breath period

Figure 9-2 shows an apnea interval greater than the breath period.

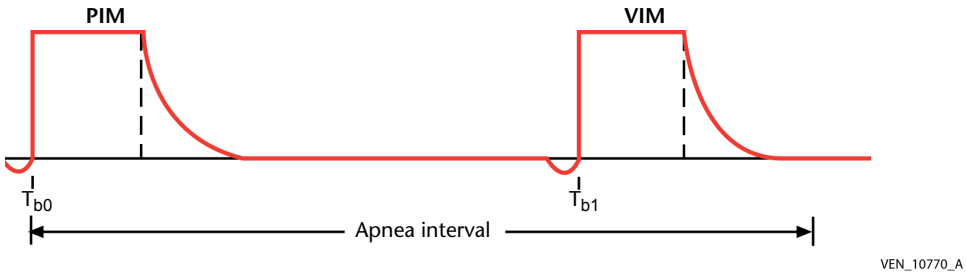

Figure 9-2. Apnea interval greater than breath period

Figure 9-3 shows an apnea interval less than the breath period.

PIM or OIM needed to block apnea ventilation

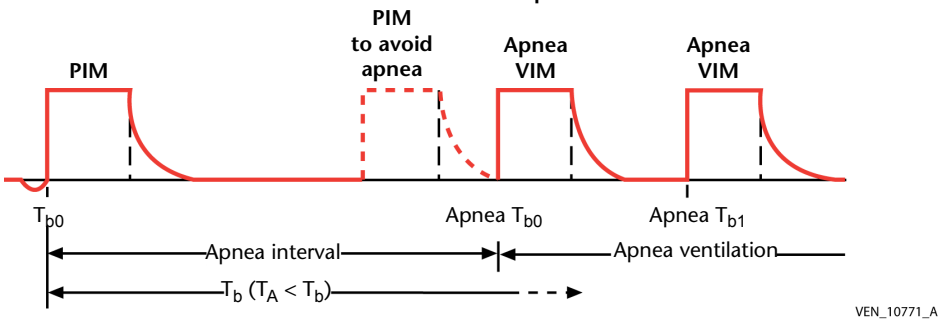

Figure 9-3. Apnea interval less than breath period

9.2 Transition to apnea ventilation

When apnea is declared, the ventilator delivers apnea ventilation according to the current apnea ventilation settings and displays the apnea settings on the upper screen of the graphic user interface (GUI). Regardless of the apnea interval setting, apnea ventilation cannot begin until inspiration is complete and the restricted phase of exhalation has elapsed.

9.3 Key entries during apnea ventilation

All apnea and non-apnea settings remain active on the GUI during apnea ventilation. Both non-apnea and apnea settings changes are phased in according to the applicable rules (see Technical Reference Chapter 11 for information on phasing in settings). If apnea ventilation is active, new settings are accepted but not implemented until non-apnea ventilation begins. Allowing key entries after apnea detection allows you to adjust the apnea interval at setup, regardless of whether apnea has been detected. During apnea ventilation, the MANUAL INSP key is active, but the EXP PAUSE and INSP PAUSE keys are not active. The 100% O₂/CAL 2 min key or INCREASE O₂ 2 min key is active during apnea ventilation, because apnea detection is likely during suctioning.

9.4 Resetting apnea ventilation

Apnea ventilation is intended as a backup mode of ventilation when there is no patient inspiratory effort. Apnea ventilation can be reset to normal ventilation by the operator (manual reset) or the patient (autoreset). It is also reset when a rate change is made that renders apnea ventilation inapplicable.

If the patient regains inspiratory control, the ventilator returns to the operator-selected mode of non-apnea ventilation. The ventilator determines whether the patient has regained respiratory control by monitoring triggered inspirations and exhaled volume. If the patient triggers two consecutive inspirations, and the exhaled volume is equal to or greater than 50% of the delivered volume (including any compliance volume), the ventilator resets to non-apnea ventilation. Exhaled volume is

monitored to avoid resetting due to autotriggering caused by large leaks in the patient circuit.

9.4.1 Resetting to A/C

Switching to A/C from apnea ventilation causes the ventilator to deliver a VIM and set the start time for the beginning of the first A/C cycle. The second VIM breath is phased in according to these rules:

- The VIM is not delivered during an inspiration.
- The VIM is not delivered until the first 200 ms of exhalation have elapsed and the expiratory flow is $\leq 50\%$ of peak expiratory flow.
- The time until the first VIM is delivered is 3.5 times the apnea inspiratory time, or the apnea breath period, whichever occurs first.

9.4.2 Resetting to SIMV

Switching to SIMV from apnea ventilation causes the ventilator to deliver a VIM and set the start time for the beginning of the first SIMV cycle. Unless the patient triggers a synchronized PIM first, the VIM breath is phased in according to these rules:

- The VIM is not delivered during an inspiration.
- The VIM is not delivered during the restricted phase of exhalation.
- The time until the first VIM is delivered is 3.5 times the apnea inspiratory time, or the apnea breath period, whichever occurs first.

9.4.3 Resetting to SPONT

Once the ventilator switches to SPONT from apnea ventilation, the apnea interval begins at the start of the last or current apnea breath. The ventilator waits for detection of inspiratory effort, a manual inspiration, or apnea detection. If a valid breath is not delivered before the apnea interval elapses, the ventilator re-enters apnea ventilation.

9.5 Phasing in new apnea intervals

These rules apply to apnea settings:

- The apnea respiratory rate must be greater than or equal to $60/T_A$.
- Apnea settings cannot result in an I:E ratio greater than 1.00:1.

How a new apnea interval is phased in depends on whether or not apnea ventilation is active. If apnea ventilation *is* active, the ventilator accepts and implements the new setting immediately. During normal ventilation (that is, apnea ventilation is not active), these rules apply:

- If the new apnea interval setting is shorter than the current (or temporarily extended) apnea interval, the new value is implemented at the next inspiration.
- If the new apnea interval setting is longer than the current (or temporarily extended) apnea interval, the old interval is extended to match the new interval immediately.

This page is intentionally blank.

The Puritan Bennett™ 840 Ventilator System detects severe patient circuit occlusions to protect the patient against excessive airway pressures over extended periods of time. The ventilator is also designed to detect patient circuit disconnects because they can cause the patient to receive little or no gas from the ventilator, and require immediate clinical attention.

10.1 Occlusion

The ventilator detects a severe occlusion if:

- The inspiratory or expiratory tube is partially or completely occluded (condensate or secretions collected in a gravity-dependent loop, kinked or crimped tubing, etc.).
- The ventilator EXHAUST port or device attached to it is fully blocked.
- The exhalation valve fails in the closed position (occlusion detection at the “From patient” port begins after 200 ms of exhalation has passed).

The ventilator does *not* declare a severe occlusion if:

- The pressure difference between the inspiratory and the expiratory transducers is less than or equal to 5 cmH₂O.
- The exhalation valve fails in the closed position and the pressure in the exhalation limb is less than 2 cmH₂O.
- Silicone tubing is attached to the EXHAUST port of the ventilator (e.g. for metabolic monitoring purposes).

The ventilator checks the patient circuit for occlusions during all modes of breathing (except idle mode and safety valve open) at every breath delivery cycle. Once the circuit check begins, the ventilator detects a severe occlusion of the patient circuit within 200 ms. The ventilator checks the EXHAUST port for occlusions during the expiratory phase of every breath (except during disconnect and safety valve open). Once the EXHAUST port check begins, the ventilator detects a severe occlusion within 100 ms

following the first 200 ms of exhalation. All occlusion checking is disabled during pressure sensor autozeroing.

The ventilator uses different algorithms for detecting occlusions in the breathing circuit and at the exhalation exhaust port. For occlusions of the breathing circuit, a pressure-drop limit threshold has been established based on circuit type (Adult, Pediatric, or Neonatal) and the maximum of the inspiratory or expiratory flows. For occlusions at the exhalation exhaust port, a pressure-drop limit threshold has been established using exhaled flow, expiratory pressure and PEEP values. During ventilation, the actual pressure-drops across the patient circuit and expiratory valve are continuously monitored and compared with their respective limit threshold values. If the actual values exceed their threshold limit values for specified time intervals, a severe occlusion is detected.

Once a severe occlusion is detected, the ventilator acts to minimize airway pressure. Because any severe occlusion places the patient at risk, the ventilator minimizes the risk while displaying the length of time the patient has been without ventilatory support. Severe occlusion is detected regardless of what mode or triggering strategy is in effect. When a severe occlusion is detected, the ventilator terminates normal ventilation, terminates any active alarm silence, annunciates an occlusion alarm, and enters the safe state (exhalation and inspiratory valve de-energized and safety valve open) for 15 seconds or until inspiratory pressure drops to 5 cmH₂O or less, whichever comes first.

During a severe occlusion, the ventilator enters *occlusion status cycling* (OSC), in which it periodically attempts to deliver a pressure-based breath while monitoring the inspiration and expiration phases for the existence of a severe occlusion. If the severe occlusion is corrected, the ventilator detects the corrected condition after two complete OSC breath cycles during which no occlusion is detected. When the ventilator delivers an OSC breath, it closes the safety valve and waits 500 ms for the safety valve to close completely, delivers a breath with a target pressure of 15 cmH₂O for 2000 ms, then cycles to exhalation. This breath is followed by a mandatory breath according to the current settings, but with PEEP=0 and O₂% equal to 100% (adult/

pediatric) or 40% (neonatal). During OSC (and only during OSC), the $\bar{\uparrow}P_{PEAK}$ (high circuit pressure) alarm limit is disabled to ensure it does not interfere with the ability of the ventilator to detect a corrected occlusion. When the ventilator does not detect a severe occlusion, it resets the occlusion alarm, re-establishes PEEP, and reinstates breath delivery according to current settings.

Apnea detection, inspiratory and expiratory pause, and manual inspirations are suspended during a severe occlusion. Pause maneuvers are canceled by a severe occlusion. During a severe occlusion, you can change ventilator settings.

10.2 Disconnect

The ventilator bases its disconnect detection strategy on variables specific to each breath type. The ventilator's disconnect detection strategy is designed to detect actual disconnects (at the inspiratory limb, expiratory limb, or patient wye) while rejecting false detections.

The ventilator monitors the expiratory pressure and flow, delivered volume, and exhaled volume to declare a disconnect using any of these methods:

- The ventilator detects a disconnect when the expiratory pressure transducer measures no circuit pressure and no exhaled flow during the first 200 ms of exhalation. The ventilator postpones declaring a disconnect for another 100 ms to allow an occlusion (if detected) to be declared first, because it is possible for an occlusion to match the disconnect detection criteria.
- Despite many possible variations of circuit disconnections and/or large leaks, it is possible for a patient to generate some exhaled flow and pressure. The ventilator then uses the *disconnect sensitivity* (D_{SENS} , the percentage of delivered volume lost during the exhalation phase of the same breath to declare a disconnect) setting to detect a disconnect.
- If the disconnect occurs during a spontaneous breath, a disconnect is declared when the inspiration is terminated by maximum inspiratory time (or the $\bar{\uparrow}T_{I_{SPONT}}$ limit setting when Vent Type is NIV) and the ventilator detects inspiratory flow rising to the maximum allowable.

- If the disconnect occurs at the patient side of the endotracheal tube, the exhaled volume will be much less than the delivered volume for the previous inspiration. The ventilator declares a disconnect if the exhaled volume is lower than the D_{SENS} setting for 3 consecutive breaths. The D_{SENS} setting helps avoid false detections due to leaks in the circuit or the patient's lungs, and the 3 consecutive breaths requirement helps avoid false detections due to a patient out-drawing the ventilator during volume control (VC) breaths.
- Flow less than a value determined using the D_{SENS} setting and pressure less than 0.5 cmH₂O detected for 10 consecutive seconds during exhalation.

Warning

When Vent Type is NIV, and D_{SENS} setting is turned OFF, the system may not detect large leaks and some disconnect conditions it would declare as alarms during INVASIVE ventilation.

Once the ventilator detects a patient circuit disconnect, the ventilator declares a high-urgency alarm and enters *idle mode*, regardless of what mode (including apnea) was active when the disconnect was detected. If there is an active alarm silence when the disconnect occurs, the alarm silence is NOT cancelled. The ventilator displays the length of time the patient has been without ventilatory support. During idle mode, the exhalation valve opens, *idle flow* (10 L/min flow at 100% O₂ (or 40% O₂ in *NeoMode*), if available) begins, and breath triggering is disabled.

The ventilator monitors both expiratory flow and circuit pressures to detect reconnection. The ventilator declares a reconnect if any of the following criteria are met for the applicable time interval: exhaled idle flow within the reconnect threshold is detected; inspiratory and expiratory pressures are both above or both below reconnect threshold levels; or inspiratory pressure rises to a reconnect level. If the disconnect condition is corrected, the ventilator detects the corrected condition within 100 to 1000 ms.

Flow or pressure triggering, apnea detection, expiratory and inspiratory pause, manual inspirations, and programmed maneuvers or one-time events are suspended during a patient

circuit disconnect condition. Spirometry is not monitored during a disconnect, and all alarms based on spirometry values are disabled. During a disconnect condition, you can change ventilator settings.

If the disconnect alarm is autoreset or manually reset, the ventilator re-establishes PEEP. Once PEEP is reestablished, the ventilator reinstates breath delivery according to settings in effect before the disconnect was detected. Pause maneuvers are canceled during a disconnect.

10.3 Occlusions and disconnect annunciation

Occlusion and disconnection cannot be declared at the same time. Therefore, the ventilator annunciates only the first event to be declared. If an occlusion occurs during *idle mode*, however, it can be detected if the breathing circuit becomes disconnected at the wye or expiratory filter.

This page is intentionally blank.

Phasing in setting changes

These rules govern how the Puritan Bennett™840 Ventilator System phases in setting changes:

- Individual settings are handled separately and phased in according to the rule for each setting.
- Batch settings and individual settings not yet phased in are merged together. If there are conflicting settings, the most recently entered value is used.
- Breath delivery batch settings are phased in according to the phase-in requirements of the individual settings. Settings are phased in using the most economical manner, applying the most restrictive rules.
- Apnea interval, flow sensitivity, pressure sensitivity, exhalation sensitivity, and disconnect sensitivity are considered batch-independent and are phased in according to their individual rules.
- During non-apnea ventilation, apnea-specific settings are ready when apnea ventilation begins.
- During apnea ventilation, non-apnea settings are ready when normal ventilation begins. Apnea settings and shared settings (for example, PEEP) are phased in according to batch setting rules.

This page is intentionally blank.

Ventilator settings

This chapter provides supplementary information about selected ventilator settings for the Puritan Bennett™ 840 Ventilator System. For settings ranges, resolutions, new patient values, and accuracy of all ventilator settings, see Table A-13 in Appendix A of this manual.

Current settings are saved in non-volatile memory. All ventilator settings have absolute limits, which are intended to prevent settings outside the permissible operational range of the ventilator. Some settings require an acknowledgement to proceed beyond the recommended limit. Most setting limits are restricted by ideal body weight (IBW), circuit type, or the interrelationship with other settings.

12.1 Apnea ventilation

Apnea ventilation is a backup mode. Apnea ventilation starts if the patient fails to breathe for a time that exceeds the apnea interval (T_A) currently in effect. T_A is an operator setting that defines the maximum allowable time between the start of inspiration and the start of the next inspiration. Apnea ventilation settings include respiratory rate (f), $O_2\%$, mandatory type (volume control, VC, or pressure control, PC), tidal volume (V_T), flow pattern, peak inspiratory flow (\dot{V}_{MAX}), inspiratory pressure (P_I), and inspiratory time (T_I). If the apnea mandatory breath type is VC, plateau time (T_{PL}) is 0.0 seconds. If the apnea mandatory breath type is PC, rise time % is 50%, and T_I is constant during rate change.

Because the minimum value for T_A is 10 seconds, apnea ventilation cannot be invoked when non-apnea f is greater than or equal to 5.8/min. The ventilator does not enter apnea ventilation if T_A is equal to the breath cycle interval. You can set T_A to a value less than the expected or current breath cycle interval as a way of allowing the patient to initiate breaths while protecting the patient from the consequences of apnea.

Apnea settings are subject to these rules:

- Apnea ventilation $O_2\%$ must be set equal to or greater than non-apnea ventilation $O_2\%$.
- Minimum apnea f is $(60/T_A)$.
- Apnea ventilation settings cannot result in an I:E ratio greater than 1.00:1.

If apnea is possible (that is, if $(60/f) > T_A$) and you increase the non-apnea $O_2\%$ setting, apnea ventilation $O_2\%$ automatically changes to match if it is not already set higher than the new non-apnea $O_2\%$. Apnea ventilation $O_2\%$ does not automatically change if you decrease the non-apnea $O_2\%$. Whenever there is an automatic change to an apnea setting, a message is displayed on the graphic user interface (GUI), and the subscreen for apnea settings appears.

During apnea ventilation you can change T_A and all non-apnea settings, but the new settings do not take effect until the ventilator resumes normal ventilation. Being able to change T_A during apnea ventilation can avoid immediately re-entering apnea ventilation once normal ventilation resumes.

12.2 Circuit type and Ideal Body Weight (IBW)

Together, the circuit type and IBW settings determine the new patient values and absolute limits on various apnea and non-apnea settings including V_T and \dot{V}_{MAX} . You must run SST to change the circuit type. While IBW is being set or viewed, its value is displayed in kilograms (kg) and pounds (lb).

Based on the circuit type and IBW, the ventilator calculates V_T settings as follows:

Circuit type	New patient default V_T	Minimum V_T	Maximum V_T
Neonatal	greater of 2 mL or 7.25 mL/kg x IBW	2 mL	45.7 mL/kg x IBW and $< V_{TI, MAND}$ alarm limit setting in VC+
Pediatric	7.25 mL/kg x IBW	25 mL	
Adult	7.25 mL/kg x IBW	1.16 mL/kg x IBW	

Based on the circuit type, the ventilator calculates \dot{V}_{MAX} settings as follows:

- Maximum $\dot{V}_{MAX} = 30$ L/min for Neonatal patient circuits
- Maximum $\dot{V}_{MAX} = 60$ L/min for Pediatric patient circuits
- Maximum $\dot{V}_{MAX} = 150$ L/min for Adult patient circuits

The IBW setting also determines the constants used in breath delivery algorithms, some user-settable alarms, the non-settable INSPIRATION TOO LONG alarm, and the high spontaneous inspiratory time limit setting ($\uparrow T_{I SPONT}$).

12.3 Disconnect sensitivity (D_{SENS})

The D_{SENS} setting defines the percentage of returned volume lost, above which the ventilator declares a CIRCUIT DISCONNECT alarm. When D_{SENS} is set to its lowest value (20%), it has the highest sensitivity for detecting a disconnect or leak. When D_{SENS} is set to its highest value (95%), the ventilator has the least sensitivity for detecting a circuit disconnection, as greater than 95% of the returned volume must be lost before the alarm occurs. During NIV, the default D_{SENS} setting is OFF, which is equivalent to a returned volume loss of 100%.

NOTE:

If D_{SENS} is set to OFF during NIV, the ventilator is still capable of declaring a CIRCUIT DISCONNECT alarm.

12.4 Expiratory sensitivity (E_{SENS})

The E_{SENS} setting defines the percentage of the projected peak inspiratory flow at which the ventilator cycles from inspiration to exhalation. When inspiratory flow falls to the level defined by E_{SENS} , exhalation begins. E_{SENS} is active during every spontaneous breath. E_{SENS} is a primary setting and is accessible from the lower GUI screen. Changes to the E_{SENS} setting are phased in any time during inspiration or exhalation.

E_{SENS} complements rise time %. Rise time % should be adjusted to match the patient's inspiratory drive, and the E_{SENS} setting should cause ventilator exhalation at a point most appropriate for the

patient. The higher the E_{SENS} setting, the shorter the inspiratory time. Generally, the most appropriate E_{SENS} is compatible with the patient's condition, neither extending nor shortening the patient's intrinsic inspiratory phase.

12.5 Expiratory time (T_E)

The T_E setting defines the duration of exhalation for PC mandatory and VC+ breaths only. Changes to the T_E setting are phased in at the start of inspiration. Setting f and T_E automatically determines the value for I:E ratio and T_I .

12.6 Flow pattern

The flow pattern setting defines the gas flow pattern of volume-controlled (VC) mandatory breaths. The selected values for V_T and \dot{V}_{MAX} apply to either the square or descending ramp flow pattern. If V_T and \dot{V}_{MAX} are held constant, T_I approximately halves when the flow pattern changes from descending ramp to square (and approximately doubles when flow pattern changes from square to descending ramp), and corresponding changes to the I:E ratio also occur. Changes in flow pattern are phased in during exhalation or at the start of inspiration.

The settings for flow pattern, V_T , f , and \dot{V}_{MAX} are interrelated, and changing any of these settings causes the ventilator to generate new values for the other settings. If any setting change would cause any of the following, the ventilator does not allow you to select that setting and displays a limit-violation message:

- I:E ratio > 4:1
- $T_I > 8.0$ seconds or $T_I < 0.2$ second
- $T_E < 0.2$ second

12.7 Flow sensitivity (\dot{V}_{SENS})

The \dot{V}_{SENS} setting defines the rate of flow inspired by a patient that triggers the ventilator to deliver a mandatory or spontaneous breath. When \dot{V}_{SENS} is on, a base flow of gas travels through the patient circuit. The patient inhales from the base flow. When the patient's inspiratory flow equals the \dot{V}_{SENS} setting, the ventilator

delivers a breath. Once a value for flow sensitivity is selected, the ventilator delivers a base flow equal to $\dot{V}_{\text{SENS}} + 1.5 \text{ L/min}$ (base flow is not user-selectable). Changes in \dot{V}_{SENS} are phased in at the start of exhalation or during inspiration.

For example, if you select a \dot{V}_{SENS} of 4 L/min, the ventilator establishes a base flow of 5.5 L/min through the patient circuit. When the patient inspires at a rate of 4 L/min, the corresponding 4 L/min decrease in the base flow triggers the ventilator to deliver a breath.

When \dot{V}_{SENS} is active, it replaces pressure sensitivity (P_{SENS}). The \dot{V}_{SENS} setting has no effect on the P_{SENS} setting. \dot{V}_{SENS} can be active in any ventilation mode (including pressure supported, volume controlled, pressure controlled, and apnea ventilation). When \dot{V}_{SENS} is active, a backup P_{SENS} setting of 2 cmH₂O is in effect to detect the patient's inspiratory effort, even if the flow sensors do not detect flow.

Although the minimum \dot{V}_{SENS} setting of 0.2 L/min (adult/pediatric circuit types) or 0.1 L/min (neonatal circuit type) can result in autotriggering (that is, when the ventilator delivers a breath based on fluctuating flows not caused by patient demand), it can be appropriate for very weak patients. The maximum setting of 20 L/min (adult/pediatric circuit types) or 10 L/min (neonatal circuit type) is intended to avoid autotriggering when there are significant leaks in the patient circuit. The selected \dot{V}_{SENS} is phased in during inspiration or at the start of exhalation in case the patient cannot trigger a breath using the previous sensitivity setting.

12.8 High spontaneous inspiratory time limit ($\uparrow T_{\text{I SPONT}}$)

The high spontaneous inspiratory time limit setting is available only in SIMV or SPONT modes during NIV, and provides a means for setting a maximum inspiratory time after which the ventilator automatically transitions to exhalation. It replaces the non-settable INSPIRATION TOO LONG alarm active when Vent Type is INVASIVE. The $\uparrow T_{\text{I SPONT}}$ setting is based upon circuit type and IBW. For neonatal circuit types, the new patient default value is:

$$(1 + (0.1 \times \text{IBW})) \text{ sec}$$

For pediatric/adult circuit types, the new patient default value is:
(1.99 + (0.02 x IBW)) sec

The $\uparrow T_{I\text{ SPONT}}$ indicator appears at the beginning of a ventilator-initiated exhalation and remains visible for as long as the ventilator truncates breaths in response to the $\uparrow T_{I\text{ SPONT}}$ setting. The $\uparrow T_{I\text{ SPONT}}$ indicator disappears when the patient's inspiratory time returns to less than the $\uparrow T_{I\text{ SPONT}}$ setting, or after 15 seconds has elapsed after the beginning of exhalation of the last truncated breath.

12.9 Humidification type

The humidification type setting allows you to select the type of humidification system (heated expiratory tube, non-heated expiratory tube, or heat-moisture exchanger -- HME) being used on the ventilator and can be changed during normal ventilation or short self test (SST). Changes in humidification type are phased in at the start of inspiration.

SST calibrates spirometry partly based on the humidification type. If you change the humidification type without rerunning SST, then the accuracy of spirometry and delivery may be affected.

The output of the exhalation flow sensor varies depending on the water vapor content of the expiratory gas, which depends on the type of humidification system in use. Because the temperature and humidity of gas entering the expiratory filter differ based on the humidification type, spirometry calculations also differ according to humidification type. For optimum accuracy, rerun SST to change the humidification type.

12.10 I:E ratio

The I:E setting defines the ratio of inspiratory time to expiratory time for mandatory PC breaths. The ventilator accepts the specified range of direct I:E ratio settings as long as the resulting T_I and T_E settings are within the ranges established for mandatory breaths. You cannot directly set the I:E ratio in VC mandatory breaths. Changes in the I:E ratio are phased in at start of inspiration.

Setting f and I:E automatically determines the value for T_I and T_E . The maximum I:E ratio setting of 4.00:1 is the maximum that allows adequate time for exhalation and is intended for inverse ratio pressure control ventilation.

12.11 Ideal body weight (IBW)

Refer to Section 12.2.

12.12 Inspiratory pressure (P_I)

The P_I setting determines the pressure at which the ventilator delivers gas to the patient during a PC mandatory breath. The P_I setting only affects the delivery of PC mandatory breaths. The selected P_I is the pressure above PEEP. (For example, if PEEP is set to 5 cmH₂O, and P_I is 20 cmH₂O, the ventilator delivers gas to the patient at 25 cmH₂O.) Changes to the P_I setting are phased in during exhalation or at the start of inspiration.

The sum of PEEP + P_I + 2 cmH₂O cannot exceed the high circuit pressure (\bar{P}_{PEAK}) limit. To increase this sum of pressures, you must first raise the \bar{P}_{PEAK} limit before increasing the settings for PEEP or P_I .

12.13 Inspiratory time (T_I)

The T_I setting defines the time during which an inspiration is delivered to the patient for PC mandatory breaths. You cannot set T_I in VC mandatory breaths. The ventilator accepts a T_I setting as long as the resulting I:E ratio and T_E settings are valid. Changes in the T_I are phased in at the start of inspiration.

The ventilator rejects T_I settings that result in an I:E ratio greater than 4.00:1, a T_I greater than eight seconds or less than 0.2 second, or a T_E less than 0.2 second to ensure the patient has adequate time for exhalation. (For example, if the f setting is 30/min, a T_I setting of 1.8 seconds would result in an I:E ratio of 9:1 - which is out of range for I:E ratio settings.)

Inspiratory time is offered in addition to I:E ratio because the T_I setting is commonly used for pediatric and infant ventilation and may be a more useful setting at lower respiratory rates. Setting f and T_I automatically determines the value for I:E and T_E ($60/f - T_I = T_E$). This equation summarizes the relation between T_I , I:E, T_E , and cycle time ($60/f$):

$$T_I = (60/f) [(I:E)/(1 + I:E)]$$

If the f setting remains constant, any one of the three variables (T_I , I:E, or T_E) can define the inspiratory and expiratory intervals. If the f setting is low (and additional spontaneous patient efforts are expected), T_I can be a more useful variable to set than I:E. As the f setting increases (and the fewer patient-triggered breaths are expected), the I:E setting becomes more relevant. Regardless of which variable you choose to set, a breath timing bar always shows the interrelationship between T_I , I:E, T_E , and f .

12.14 Mode and mandatory breath type

Specifying the mode defines the types and sequences of breaths allowed for both INVASIVE and NIV Vent Types, as summarized in Table 12-1.

Table 12-1: Puritan Bennett 840 ventilator modes and breath types

Mode	Mandatory breath type	Spontaneous breath type	Sequence
A/C	INVASIVE: VC, VC+, or PC NIV: VC or PC	Not allowed	All mandatory (ventilator-, patient-, or operator-initiated)
SIMV	INVASIVE: PC, VC, or VC+ NIV: VC or PC	INVASIVE: Pressure-supported (PS), Tube-compensated (TC), or none (that is, CPAP breath) NIV: PS or none	Each new breath begins with a mandatory interval, during which a patient effort yields a synchronized mandatory breath. If no patient effort is seen during the mandatory interval, the ventilator delivers a mandatory breath. Subsequent patient efforts before the end of the breath yield spontaneous breaths.
SPONT	Not allowed (PC or VC allowed only for manual inspirations)	INVASIVE: pressure supported (PS), tube compensated (TC), volume supported (VS), proportionally assisted (PA), or none (that is, CPAP breath) NIV: PS or none	All spontaneous (except for manual inspirations)
BILEVEL (INVASIVE Vent Type only)	PC	PS, TC, or none	Combines mandatory and spontaneous breathing modes. Refer to the <i>BiLevel</i> Software Option Addendum for more information.
CPAP	PC or VC	N/A	All spontaneous (except for manual inspirations) Refer to the NeoMode Option Addendum for more information on Neo nCPAP

Breath types must be defined before settings can be specified. There are only two kinds of breath type: mandatory and spontaneous. Mandatory breaths are volume controlled (VC) or pressure controlled (PC or VC+). The Puritan Bennett 840 Ventilator System currently offers spontaneous breaths that are pressure supported (PS), volume supported (VS), tube compensated (TC), proportionally assisted (PA), or not pressure supported (that is, the “classic” CPAP breath with no pressure support). Figure 12-1 shows the modes and breath types available on the Puritan Bennett 840 Ventilator System.

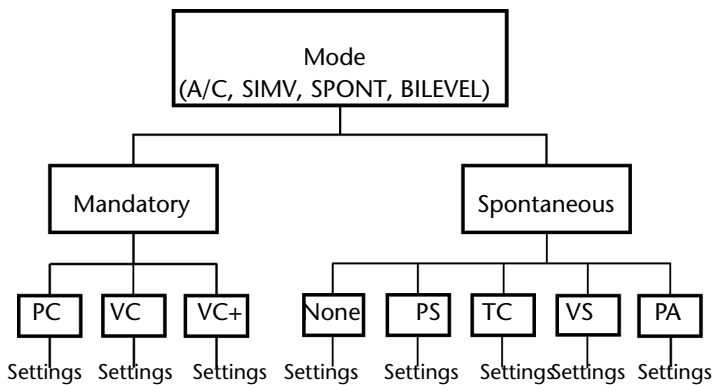

VEN_10772_A

Figure 12-1. Puritan Bennett 840 Ventilator System modes and breath types

The mode setting defines the interaction between the ventilator and the patient.

- *Assist/control (A/C) mode* allows the ventilator to control ventilation within boundaries specified by the practitioner. All breaths are mandatory, and can be PC, VC, or VC+.
- *Spontaneous (SPONT) mode* allows the patient to control ventilation. The patient must be able to breathe independently, and exert the effort to trigger ventilator support.

- *Synchronous intermittent mandatory ventilation (SIMV)* is a mixed mode that allows a combination of mandatory and spontaneous interactions. In SIMV, the breaths can be spontaneous or mandatory, mandatory breaths are synchronized with the patient's inspiratory efforts, and breath delivery is determined by the f setting.
- *BiLevel* is a mixed mode that combines both mandatory and spontaneous breath types. Breathes are delivered in a manner similar to SIMV mode with PC selected, but providing two levels of PEEP. The patient is free to initiate spontaneous breaths at either PEEP level during *BiLevel*.

Changes to the mode are phased in at start of inspiration. Mandatory and spontaneous breaths can be flow- or pressure-triggered.

The ventilator automatically links the mandatory type setting to the mode setting. During A/C or SIMV modes, once the operator has specified volume or pressure, the ventilator displays the appropriate breath parameters. Changes in the mandatory type are phased in during exhalation or at start of inspiration.

12.15 O₂%

The Puritan Bennett 840 Ventilator System's oxygen sensor uses a galvanic cell to monitor O₂%. This cell is mounted on the inspiratory manifold of the BDU and monitors the percentage of oxygen in the mixed gas (not the actual oxygen concentration in the gas the patient inspires). Changes to the O₂% setting are phased in at the start of inspiration or the start of exhalation.

The O₂% setting can range from room air (21%) up to a maximum of 100% oxygen. The galvanic cell reacts with oxygen to produce a voltage proportional to the partial pressure of the mixed gas. Since ambient atmosphere contains approximately 21% oxygen, the galvanic cell constantly reacts with oxygen and always produces a voltage. Constant exposure to 100% O₂ would drain the cell in approximately 7,500 hours (44.5 weeks of constant use). Constant exposure to room air (21% O₂) would drain the cell in approximately 35,000 hours (4 years and 4 weeks of constant use). The life of the cell can also be shortened by exposure to elevated temperatures and pressures. During normal use in the

ICU, cell life easily exceeds 10,000 hours — the interval for routine preventive maintenance.

Because the galvanic cell constantly reacts with oxygen, it requires periodic calibration to prevent inaccurate O₂% alarm annunciation. The Puritan Bennett 840 ventilator calibrates its oxygen sensor at the end of the 2-minute time interval started by pressing the 100% O₂/CAL 2 min key or the INCREASE O₂ 2 min key. See page TR 15-6 for more information on calibrating the oxygen sensor. Cancelling the 100% O₂/CAL operation prior to the end of the 2-minute interval will result in the O₂ sensor not being calibrated. Once a calibrated oxygen sensor and the Puritan Bennett 840 ventilator reach a steady-state operating temperature, the monitored O₂% will be within 3 percentage points of the actual value for at least 24 hours. To ensure the oxygen sensor remains calibrated, press the 100% O₂/CAL 2 min key or INCREASE O₂ 2 min key at least once every 24 hours.

12.16 Peak inspiratory flow (\dot{V}_{MAX})

The \dot{V}_{MAX} setting determines the maximum rate of delivery of tidal volume to the patient during mandatory VC breaths. Changes in \dot{V}_{MAX} are phased in during exhalation or at the start of inspiration. The \dot{V}_{MAX} setting only affects the delivery of mandatory breaths. Mandatory breaths are compliance-compensated even at the maximum \dot{V}_{MAX} setting.

When you propose a change to the \dot{V}_{MAX} setting, the ventilator compares the new value with the settings for V_T , f , flow pattern, and T_{PL} . It is impossible to set a new \dot{V}_{MAX} that would result in an I:E ratio that exceeds 4.00:1, or a T_I greater than 8.0 seconds or less than 0.2 second, or a T_E less than 0.2 second.

12.17 PEEP

This setting defines the positive end-expiratory pressure (PEEP), also called baseline pressure. PEEP is the positive pressure maintained in the patient circuit during exhalation. Changes to the PEEP setting are phased in at start of exhalation (if PEEP is increased or decreased) or at start of inspiration (only if PEEP is decreased).

The sum of:

- PEEP + 7 cmH₂O, or
- PEEP + P_I + 2 cmH₂O (if PC is active), or
- PEEP + P_{SUPP} + 2 cmH₂O (if PS is on)

cannot exceed the $\bar{\uparrow}P_{PEAK}$ limit. To increase the sum of pressures, you must first raise the $\bar{\uparrow}P_{PEAK}$ limit before increasing the settings for PEEP, P_I, or P_{SUPP}.

12.17.1 PEEP restoration

If there is a loss of PEEP from occlusion, disconnect, Safety Valve Open, or loss of power conditions, PEEP is re-established (when the condition is corrected) by the ventilator delivering a PEEP restoration breath. The PEEP restoration breath is a 1.5 cmH₂O pressure-supported breath with exhalation sensitivity of 25%, and rise time % of 50%. A PEEP restoration breath is also delivered at the conclusion of Vent Startup. After PEEP is restored, the ventilator resumes breath delivery at the current settings.

12.18 Plateau time (T_{PL})

The T_{PL} setting defines the amount of time inspiration is held in the patient's airway after inspiratory flow has ceased. T_{PL} is available only during VC mandatory breaths (for A/C and SIMV mode, and operator-initiated mandatory breaths). T_{PL} is not available for PC mandatory breaths. Changes to the T_{PL} setting are phased in at the start of inspiration or during exhalation.

When you propose a change to the T_{PL} setting, the ventilator computes the new I:E ratio and T_I, given the current settings for V_T, f, \dot{V}_{MAX} , and flow pattern. It is impossible to set a new T_{PL} that would result in an I:E ratio that exceeds 4:1, or a T_I greater than eight seconds or less than 0.2 second, or a T_E less than 0.2 second. For I:E ratio calculation, T_{PL} is considered part of the inspiration phase.

12.19 Pressure sensitivity (P_{SENS})

The P_{SENS} setting selects the pressure drop below baseline (PEEP) required to begin a patient-initiated breath (either mandatory or spontaneous). Changes in P_{SENS} are phased in any time during exhalation or inspiration. The P_{SENS} setting has no effect on the \dot{V}_{SENS} setting and is active only if the trigger type is P-TRIG.

Lower P_{SENS} settings provide greater patient comfort and require less patient effort to initiate a breath. However, fluctuations in system pressure can cause autotriggering at very low P_{SENS} settings. The maximum P_{SENS} setting avoids autotriggering under worst-case conditions if patient circuit leakage is within specified limits.

The ventilator phases in a new P_{SENS} setting immediately (rather than at the next inspiration) in case the patient cannot trigger a breath using the previous sensitivity setting.

12.20 Pressure support (P_{SUPP})

The P_{SUPP} setting determines the level of positive pressure supplied to the patient's airway during a spontaneous breath. P_{SUPP} is only available in SIMV, SPONT, and BILEVEL, in which spontaneous breaths are allowed. The level of P_{SUPP} is in addition to PEEP. The P_{SUPP} setting is maintained as long as the patient inspires, and patient demand determines the flow rate. Changes to the P_{SUPP} setting are phased in during exhalation or at the start of inspiration. Pressure support affects only spontaneous breaths.

The sum of PEEP + P_{SUPP} + 2 cmH₂O cannot exceed the $\uparrow P_{\text{PEAK}}$ limit. To increase the sum of pressures, you must first raise the $\uparrow P_{\text{PEAK}}$ limit before increasing the settings for PEEP or P_{SUPP} . Since the $\uparrow P_{\text{PEAK}}$ limit is the highest pressure considered safe for the patient, a P_{SUPP} setting that would cause a $\uparrow P_{\text{PEAK}}$ alarm requires you to first re-evaluate the maximum safe circuit pressure.

12.21 Respiratory rate (f)

The f setting determines the minimum number of mandatory breaths per minute for ventilator-initiated mandatory breaths (PC, VC, and VC+). For PC mandatory and VC+ breaths, setting f and any one of the following parameters automatically determines the value of the others: I:E, T_I , and T_E . Changes to the f setting are phased in at the start of inspiration.

The ventilator does not accept a proposed f setting if it would cause the new T_I or T_E to be less than 0.2 second, the T_I to be greater than eight seconds, or I:E ratio greater than 4.00:1. (The ventilator also applies these restrictions to a proposed change to the apnea respiratory rate, except that apnea I:E cannot exceed 1.00:1.)

12.22 Rise time %

The rise time % setting allows you to adjust how quickly the ventilator generates inspiratory pressure for pressure-based breaths (that is, spontaneous breaths with PS (including a setting of 0 cmH₂O)), PC mandatory, or VC+ breaths. The higher the value of rise time %, the more aggressive (and hence, the more rapid) the rise of inspiratory pressure to the target (which equals PEEP + P_I (or P_{SUPP})). The rise time % setting only appears when pressure-based breaths are available (when PC is selected or spontaneous breaths are available).

- For PC breaths, the lowest rise time setting produces a pressure trajectory reaching 95% of the inspiratory target pressure (PEEP + P_I) in 2 seconds or 2/3 of the T_I , whichever is shortest.
- For spontaneous breaths, the lowest rise time setting produces a pressure trajectory reaching 95% of the inspiratory target (PEEP + P_{SUPP}) in an interval that is a function of IBW.
- When both PC and spontaneous breaths are active, the inspiratory pressure targets as well as the pressure trajectories can be different. Changes to T_I and P_I cause PC pressure trajectories to change. Changes in rise time % are phased in during exhalation or at start of inspiration.

- When $P_{\text{SUPP}} = \text{NONE}$, the rise time % setting determines how quickly the ventilator drives circuit pressure to $\text{PEEP} + 1.5 \text{ cmH}_2\text{O}$.

You can adjust rise time % for optimum flow delivery into lungs with high impedance (that is, low compliance and high resistance) or low impedance (that is, high compliance and low resistance). To match the flow demand of an actively breathing patient, observe simultaneous pressure-time and flow-time curves, and adjust the rise time % to maintain a smooth rise of pressure to the target value. A rise time % setting reaching the target value well before the end of inspiration can cause the ventilator to supply excess flow to the patient. Whether this oversupply is clinically beneficial must be evaluated for each patient. Generally, the optimum rise time for gently breathing patients is less than or equal to the default (50%), while optimum rise time % for more aggressively breathing patients can be 50% or higher.

Warning

Under certain clinical circumstances (such as stiff lungs, or a small patient with a weak inspiratory drive), a rise time % setting above 50% could cause a transient pressure overshoot and premature transition to exhalation, or oscillatory pressures during inspiration. Carefully evaluate the patient's condition (watch the patient's pressure-time and flow-time curves) before setting the rise time % above the default setting of 50%.

12.23 Safety ventilation

Safety ventilation is intended as a safe mode of ventilation, regardless of the type of patient (adult, pediatric, or neonate) attached. It is invoked during the power-on initialization process, or if power has been removed from the ventilator for 5 minutes or more and circuit connection is sensed before Ventilator Startup is complete.

Safety ventilation settings use the “new patient” settings, with these exceptions:

Ventilator settings	Alarm limits
Mode: A/C	$\uparrow P_{\text{PEAK}}$: 20 cmH ₂ O
Mandatory type: PC	$\uparrow \dot{V}_{\text{E TOT}}$: High alarm limit OFF, low alarm limit: 0.05 L
f: 16 /min	$\uparrow V_{\text{TE}}$: OFF
T _I : 1 s	$\uparrow f_{\text{TOT}}$: OFF
P _I : 10 cmH ₂ O	$\downarrow V_{\text{TE MAND}}$: OFF
PEEP: 3 cmH ₂ O	$\downarrow V_{\text{TE SPONT}}$: OFF
Trigger type: P-TRIG	
Rise time %: 50%	
P _{SUPP} : 2 cmH ₂ O	
O ₂ %: 100% or 40% if in <i>NeoMode</i> (21% if oxygen not available)	

12.24 Spontaneous breath type

The spontaneous breath type setting determines whether spontaneous breaths are pressure-assisted using pressure support (PS). A setting of NONE for spontaneous breath type is equivalent to a pressure support setting of 0 cmH₂O.

Once you have selected the spontaneous breath type, you can choose the level of pressure support (P_{SUPP}) and specify the rise time % and E_{SENS}. Changes to the spontaneous breath type setting are phased in during exhalation or the start of inspiration.

NOTE:

In any delivered spontaneous breath, either INVASIVE or NIV, there is always a target inspiratory pressure of 1.5 cmH₂O applied, even if Pressure Support is set to NONE or 0.

During spontaneous breathing, the patient's respiratory control center rhythmically activates the inspiratory muscles. The support type setting allows you to select pressure support to supplement the patient's pressure-generating capability.

12.25 Tidal volume (V_T)

The V_T setting determines the volume of gas delivered to the patient during a VC mandatory breath. The delivered V_T is compensated for BTPS and patient circuit compliance. Changes to the V_T setting are phased in during exhalation or at the start of inspiration. The V_T setting only affects the delivery of mandatory breaths.

When you propose a change to the V_T setting, the ventilator compares the new value with the settings for f , \dot{V}_{MAX} , flow pattern, and T_{PL} . If the proposed V_T setting is within the acceptable range but would result in an I:E ratio that exceeds 4.00:1 or a T_I greater than eight seconds or less than 0.2 second, or a T_E less than 0.2 second, the ventilator disallows the change.

12.26 Vent type

There are two Vent Type choices—INVASIVE and NIV (non-invasive). INVASIVE ventilation is conventional ventilation used with cuffed endotracheal or tracheostomy tubes. All installed software options, breath modes, breath types, and trigger types are available during INVASIVE ventilation.

NIV interfaces include non-vented full-faced or nasal masks, nasal prongs, or un-cuffed ET tubes (refer to Section 4.12.2 on page OP 4-29 for a list of interfaces that have been successfully tested with NIV).

Warning

Do not ventilate patients intubated with cuffed endotracheal or tracheostomy tubes using NIV Vent Type.

NIV enables the Puritan Bennett 840 ventilator to handle large system leaks associated with these interfaces by providing pressure-based disconnect alarms, minimizing false disconnect alarms, and replacing the INSPIRATION TOO LONG alarm with a High Spontaneous Inspiratory Time limit ($\uparrow T_{I\ SPONT}$) setting and visual indicator.

The following list shows the subset of INVASIVE settings active during NIV:

- Mode – A/C, SIMV, SPONT. (*BiLevel* is not available during NIV.)
- Mandatory type – PC or VC. (VC+ is not available during NIV.)
- Spontaneous type – PS or None. (TC and VS are not available during NIV.)
- Trigger type – Flow triggering. (Pressure triggering is not available during NIV.)

When transitioning to and from NIV, automatic settings changes take effect based upon the allowable modes and breath types. Operator's Manual Section 4.12.7 and Section 4.12.8 provide details regarding these automatic settings changes.

During NIV alarm setup, the clinician may set alarms to OFF and must determine if doing so is appropriate for the patient's condition.

This page is intentionally blank.

Alarms

This section discusses the ventilator's alarm handling strategy and provides supplementary information about selected ventilator alarms for the Puritan Bennett™ 840 Ventilator System. For settings ranges, resolutions, and new patient values of all alarms, see Table A-14 in Appendix A of this manual.

Current alarm settings are saved in nonvolatile memory. All ventilator settings have absolute limits, which are intended to prevent settings outside the safe or permissible operational range of the ventilator. These limits may be fixed or depend on other settings, such as ideal body weight (IBW).

13.1 Alarm handling

The Puritan Bennett 840 Ventilator System's alarm handling strategy is to:

- Detect and call attention to legitimate causes for caregiver concern as quickly as possible, while minimizing nuisance alarms.
- Identify the cause and suggest corrective action for an alarm where possible.
- Make it easy to discern an alarm's urgency level.
- Allow quick and easy alarm setup.

Alarm annunciations include a level of urgency, which is an estimate of how quickly a caregiver must respond to ensure patient protection. Table 13-1 summarizes alarm urgency levels.

Table 13-1: Alarm urgency levels

Urgency level	Visual indication	Audible indication	Autoreset handling
<i>High:</i> Hazardous situation requiring immediate response	Red flashing	High-priority tone (repeating sequence of five tones; sequence repeats twice, pauses, then repeats again)	If all high-urgency alarm conditions return to normal, the audible indicator turns off, the red high-urgency indicator switches from flashing to steadily lit, and autoreset is entered in the alarm history log. Press the alarm reset key to turn off the visual indicator.
<i>Medium:</i> Abnormal situation requiring prompt response	Yellow flashing	Medium-priority tone (repeating sequence of three tones)	If all medium-urgency alarm conditions return to normal, the audible and visual indicators turn off and autoreset is entered into the alarm history log.
<i>Low:</i> Change in status, informing clinician	Yellow, steadily lit	Low-priority tone (two tone, non-repeating)	If all low-urgency alarm conditions return to normal, the audible and visual indicators turn off and autoreset is entered in the alarm history log.
<i>Normal:</i> No alarm conditions active (may include autoreset alarms)	Green, steadily lit	None	Not applicable.

13.1.1 Alarm messages

In addition to displaying the urgency level of an alarm, the ventilator displays alarm messages for the two highest-priority active alarms near the top of the graphic user interface (GUI) upper screen. Figure 13-1 shows the format for alarm messages.

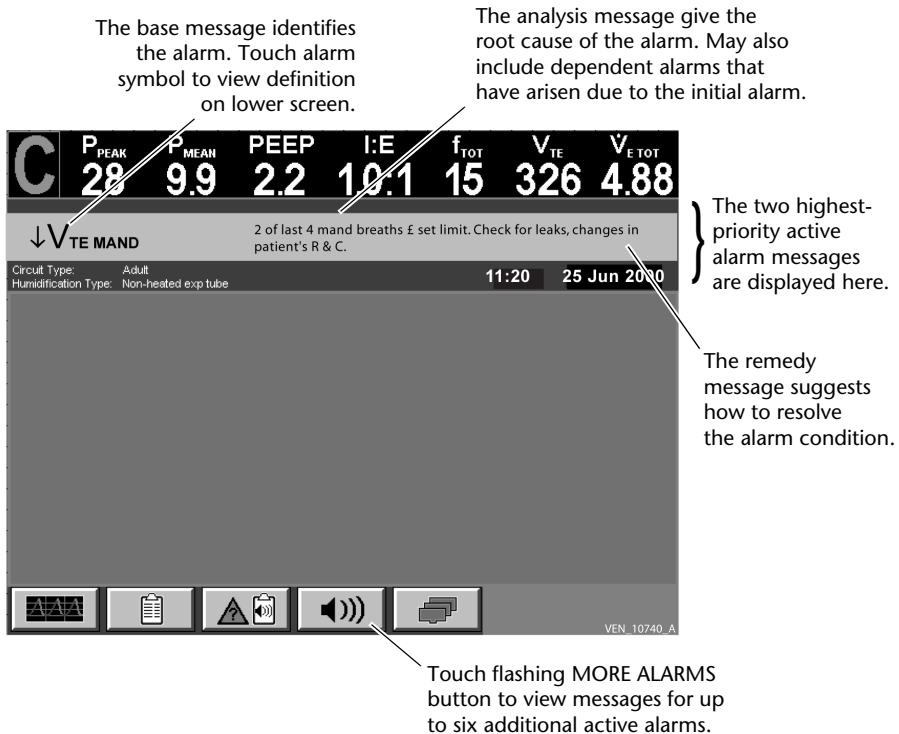

Figure 13-1. Alarm message format (upper GUI screen)

The following rules define how alarm messages are displayed:

- If the ventilator is interfaced to an external device to collect data for trending and other monitoring purposes, that external data is not considered in alarm handling.
- Initial alarms, called *primary alarms*, precede any dependent alarms, those alarms arising from *primary alarms*.
- The system adds dependent alarms to the analysis messages of each active primary alarm with which they are associated. If a dependent alarm resets, the system removes it from the analysis message of the primary alarm.
- The urgency level of a primary alarm is equal to or greater than the urgency level of any of its active dependent alarms.
- An alarm cannot be a dependent alarm of any alarm that occurs subsequently.
- If a primary alarm resets, any active dependent alarms become primary unless they are also dependent alarms of another active primary alarm.
- The system applies the new alarm limit to alarm calculations from the moment of change to an alarm limit.
- The urgency level of a dependent alarm is based solely on its detection conditions (not the urgency of any associated alarms).
- When an alarm causes the ventilator to go to idle mode, occlusion status cycling (OSC), or safety valve open (SVO), the patient data display (including waveforms) is blanked. The elapsed time without ventilatory support (that is, since idle mode, OSC, or SVO began) is displayed on the upper GUI screen. If the alarm causing idle mode, OSC, or SVO is autoreset, the ventilator resets *all* patient data alarm detection algorithms.

13.1.2 Alarm summary

Table 13-2 summarizes ventilator alarms, including urgency, messages, and other information.

Table 13-2: Alarm summary

Base message	Urgency	Analysis message	Remedy message	Comments
AC POWER LOSS	Low	Operating on battery.	Prepare for power loss.	Power switch on, AC power not available, ventilator operating on BPS. BPS operating indicator turns on. Resets when AC power is restored.
	Medium	Operational time < 2 minutes.		
APNEA (patient data alarm)	Medium	Apnea ventilation. Breath interval > apnea interval.	Check patient & settings.	The set apnea interval has elapsed without the ventilator, patient, or operator triggering a breath. Resets when patient initiates 2 consecutive breaths. Possible dependent alarm: $\downarrow \dot{V}_{E\text{TOT}}$.
	High	Extended apnea duration or multiple apnea events.		

Table 13-2: Alarm summary (cont)

Base message	Urgency	Analysis message	Remedy message	Comments
CIRCUIT DISCONNECT	High	No ventilation.	Check patient/ventilator status.	Ventilator has recovered from unintended power loss lasting more than 5 minutes, detects circuit disconnect, and switches to idle mode; upper screen displays elapsed time without ventilator support. Resets when ventilator senses reconnection.
	High	No ventilation.	Check patient. Reconnect circuit.	Ventilator detects circuit disconnect and switches to idle mode; upper screen displays elapsed time without ventilator support. Resets when ventilator senses reconnection.
COMPLIANCE LIMITED V_T (patient data alarm)	Low	Compliance compensation limit reached.	Inspired volume may be < set. Check patient and circuit type.	Compliance volume required to compensate delivery of a volume controlled breath exceeds the maximum allowed for 3 of the last 4 breaths.

Table 13-2: Alarm summary (cont)

Base message	Urgency	Analysis message	Remedy message	Comments
COMPRESSOR INOPERATIVE	Low	No compressor air. No operation during low AC power.	No remedy message displayed	Compressor ready indicator turns off. Resets when full AC power is restored.
	Low	No compressor air. No operation during AC power loss.		Ventilator turns off compressor. Resets when full AC power is restored.
	Low	No compressor air.		Compressor ready indicator turns off.
	Low	N/A	Replace compressor.	Alarm occurs when there are no LOW AC POWER and no AC POWER LOSS alarms for < 15 seconds AND time since power-on > 10 seconds.
DEVICE ALERT	Low	Breath delivery not affected.	Service required.	Background checks have detected a problem. Resets when ventilator passes EST.
	Low	Ventilation continues as set.	Replace & service ventilator.	
	Low	Breath delivery not affected. Compromised spirometry.		
	Low	Breath delivery not affected. Possible compromise of other functions.	Service required.	POST has detected a problem. Resets when ventilator passes POST.

Table 13-2: Alarm summary (cont)

Base message	Urgency	Analysis message	Remedy message	Comments
DEVICE ALERT (cont)	Medium	Ventilation continues as set.	Replace & service ventilator.	Background checks have detected a problem. Accuracy of exhalation flow sensor temperature may be affected. Resets when ventilator passes EST.
	Medium	Ventilation continues as set.		Background checks have detected a problem. Accuracy of oxygen flow sensor temperature may be affected, ventilator using nominal value. Resets when ventilator passes EST.
	Medium	Breath delivery not affected. Compromised spirometry.		Background checks have detected a problem persisting for over 10 minutes. Resets when ventilator passes EST.
	Medium	Ventilation continues as set. Only O ₂ available.		Background checks have detected a problem. Ventilator delivers 100% O ₂ . Resets when ventilator passes EST.

Table 13-2: Alarm summary (cont)

Base message	Urgency	Analysis message	Remedy message	Comments
DEVICE ALERT (cont)	Medium	Breath delivery not affected. Compromised spirometry.	Check patient. Replace & service ventilator.	Background checks have detected a problem. Accuracy of exhalation flow sensor temperature may be affected. Resets when ventilator passes EST.
	Medium	Ventilation continues as set. Only air available.	Replace & service ventilator.	Background checks have detected a problem. Ventilator delivers 21% O ₂ . Resets when ventilator passes EST.
	High	Breath delivery not affected.		Background checks have detected a problem. Loss of GUI indicator lights. Setting changes disabled. Resets when ventilator passes EST.

Table 13-2: Alarm summary (cont)

Base message	Urgency	Analysis message	Remedy message	Comments
DEVICE ALERT (cont)	High	Unable to determine status of breath delivery.	Check patient. Replace & service ventilator.	Background checks have detected a problem. Loss of GUI indicator lights. Resets when communication between GUI and BDU is re-established.
	High	Ventilation continues as set.	Replace & service ventilator.	Background checks have detected a problem. Loss of GUI indicator lights. Alarms, setting changes, and monitored data disabled. Resets when ventilator passes EST.
	High	Ventilation continues as set.	Replace & service ventilator.	Background checks have detected a problem. Setting changes, monitored data, and alarms disabled. Resets when ventilator passes EST.

Table 13-2: Alarm summary (cont)

Base message	Urgency	Analysis message	Remedy message	Comments
DEVICE ALERT (cont)	High	Ventilation continues as set. Delivery/spiro may be compromised.	Replace & service ventilator.	Background checks have detected a problem. Setting changes not allowed. Resets when ventilator passes EST.
	High	Breath delivery not affected. Compromised spiro. Trig = pres.	Check patient. Replace & service ventilator.	Background checks have detected a problem and flow triggering was selected. Accuracy of exhalation flow sensor temperature may be affected. Resets when ventilator passes EST.
	High	Ventilation continues as set, except O ₂ % = 100.	Check patient. Replace & service ventilator.	Background checks have detected a problem. Ventilator delivers 100% O ₂ instead of set O ₂ %. Resets when ventilator passes EST.

Table 13-2: Alarm summary (cont)

Base message	Urgency	Analysis message	Remedy message	Comments
DEVICE ALERT (cont)	High	Ventilation continues as set. Compromised air delivery.	Replace & service ventilator. Check patient.	Background checks have detected a problem. Accuracy of air flow sensor temperature may be affected, ventilator using nominal value. Resets when ventilator passes EST.
	High	Ventilation continues as set. Compromised O ₂ delivery.	Replace & service ventilator. Check patient.	Background checks have detected a problem. Accuracy of oxygen flow sensor temperature may be affected, ventilator using nominal value. Resets when ventilator passes EST.
	High	Power loss & recovery occurred with a pre-existing Device Alert.	Check Alarm log. EST required.	Background checks have detected a problem. Loss of GUI indicator lights. Resets when ventilator passes EST.

Table 13-2: Alarm summary (cont)

Base message	Urgency	Analysis message	Remedy message	Comments
DEVICE ALERT (cont)	High	Ventilation continues as set, except O ₂ % = 21.	Check patient. Replace & service ventilator.	Background checks have detected a problem. Ventilator delivers 21% O ₂ instead of set O ₂ %. Resets when ventilator passes EST.
	High	No ventilation. Safety Valve Open.	Provide alternate ventilation. Replace & service ventilator.	Background checks have detected a problem. Safety valve open indicator lights. Upper screen displays elapsed time without ventilator support. Resets when ventilator passes EST.
	High	No ventilation. Safety Valve Open.	Check patient. Replace & service ventilator.	
	High	No ventilation. Safety Valve Open.	Provide alternate ventilation. Replace & service ventilator.	Background checks have detected a problem. Ventilator inoperative and safety valve open indicators light. Message may not be visible. If possible, upper screen displays elapsed time without ventilator support. Resets when ventilator passes EST.

Table 13-2: Alarm summary (cont)

Base message	Urgency	Analysis message	Remedy message	Comments
↑P _{PEAK} (patient data alarm)	Low	Last breath ≥ set limit.	Check patient circuit & ET tube.	Measured airway pressure ≥ set limit. Ventilator truncates current breath unless already in exhalation. Possible dependent alarms: ↓V _{TE MAND} , ↓V _{E TOT} , ↑f _{TOT}
	Medium	Last 3 breaths ≥ set limit.		
	High	Last 4 or more breaths ≥ set limit.		
↓P _{PEAK} (patient data alarm)	Low	Last 2 breaths, pressure ≤ set limit.	Check for leaks.	Peak inspiratory pressure ≤ set limit. (Available only when Vent Type is NIV or during INVASIVE ventilation when Mandatory Type is VC+.)
	Medium	Last 4 breaths, pressure ≤ set limit.		
	High	Last 10 or more breaths, pressure ≤ set limit.		
↑O ₂ % (patient data alarm)	Medium	Measured O ₂ % > set for ≥ 30 s but < 2 min.	Check patient, gas sources, O ₂ analyzer & ventilator.	The O ₂ % measured during any phase of a breath cycle is 7% (12% during the first hour of operation) or more above the O ₂ % setting for at least 30 seconds. (These percentages increase by 5% for 4 minutes following a decrease in the O ₂ % setting.) Alarm updated at 1-second intervals.
	High	Measured O ₂ % > set for ≥ 2 min.		

Table 13-2: Alarm summary (cont)

Base message	Urgency	Analysis message	Remedy message	Comments
↑V _{TE} (patient data alarm)	Low	Last 2 breaths ≥ set limit.	Check settings, changes in patient's R & C.	Exhaled tidal volume ≥ set limit. Alarm updated whenever exhaled tidal volume is recalculated. Possible dependent alarm: ↑V _{E TOT} .
	Medium	Last 4 breaths ≥ set limit.		
	High	Last 10 or more breaths ≥ set limit.		
↑V _{E TOT} (patient data alarm)	Low	V _{E TOT} ≥ set limit for ≤ 30s.	Check patient & settings.	Expiratory minute volume ≥ set limit. Alarm updated whenever an exhaled minute volume is recalculated. Possible dependent alarm: ↑V _{TE} .
	Medium	V _{E TOT} ≥ set limit for > 30s.		
	High	V _{E TOT} ≥ set limit for > 120s.		

Table 13-2: Alarm summary (cont)

Base message	Urgency	Analysis message	Remedy message	Comments
↑f _{TOT} (patient data alarm)	Low	f _{TOT} ≥ set limit for ≤ 30s.	Check patient & settings.	Total respiratory rate ≥ set limit. Alarm updated at the beginning of each inspiration. Reset when measured respiratory rate falls below the alarm limit. Possible dependent alarms: ↓V _{TE MAND} , ↓V _{TE SPONT} , ↓V̇ _{E TOT} .
	Medium	f _{TOT} ≥ set limit for > 30s.		
	High	f _{TOT} ≥ set limit for > 120s.		
↑P _{VENT} (patient data alarm)	Low	1 breath ≥ limit.	Check patient circuit & ET tube.	Inspiratory pressure > 100 cmH ₂ O and mandatory type = VC or spontaneous type = TC or PA. Ventilator truncates current breath unless already in exhalation. Possible dependent alarms: ↓V _{TE MAND} , ↓V̇ _{E TOT} , ↑f _{TOT} .
	Medium	2 breaths ≥ limit.		
	High	3 or more breaths ≥ limit.		
INOPERATIVE BATTERY	Low	Inadequate charge or non-functional battery system.	Service/replace battery.	BPS installed but not functioning. Resets when BPS is functional.

Table 13-2: Alarm summary (cont)

Base message	Urgency	Analysis message	Remedy message	Comments
INSPIRATION TOO LONG (patient data alarm)	Low	Last 2 spont breaths = IBW based T _I limit.	Check patient. Check for leaks.	Inspiratory time for spontaneous breath ≥ IBW-based limit. Ventilator transitions to exhalation. Resets when T _I falls below IBW-based limit. Active only when Vent Type is INVASIVE.
	Medium	Last 4 spont breaths = IBW based T _I limit.		
	High	Last 10 or more spont breaths = IBW based T _I limit.		
LOSS OF POWER	High			The ventilator power switch is on and there is insufficient power from AC and the BPS (if installed). There may not be a visual indicator for this alarm, but an independent audio alarm on the BDU sounds for at least 120 seconds. Alarm annunciation can be reset by turning power switch to off position.
LOW AC POWER	Low	Ventilator currently not affected.	Power interrupt possible.	Mains (AC) power has dropped below 80% of nominal for 1 second. Ventilator continues operation as close to settings as possible. Resets when there is no low AC power signal for 1 second.

Table 13-2: Alarm summary (cont)

Base message	Urgency	Analysis message	Remedy message	Comments
LOW BATTERY	Low	Operational time < 2 minutes.	Replace or allow recharge.	Resets when BPS has more than approximately 2 minutes of operational time remaining.
↓ O ₂ % (patient data alarm)	High	Measured O ₂ % < set O ₂ %.	Check patient, gas sources, O ₂ analyzer & ventilator.	The O ₂ % measured during any phase of a breath cycle is 7% (12% during the first hour of operation) or more below the O ₂ % setting for at least 30 seconds, or below 18%. (These percentages increase by 5% for 4 minutes following an increase in the O ₂ % setting.) Alarm updated at 1-second intervals.
↓V _{TE MAND} (patient data alarm)	Low	Last 2 mand. breaths ≤ set limit.	Check for leaks, changes in patient's R & C.	Exhaled mandatory tidal volume ≤ set limit. Alarm updated whenever exhaled mandatory tidal volume is recalculated. Possible dependent alarms: ↑V _{E TOT} , ↑f _{TOT} .
	Medium	Last 4 mand. breaths ≤ set limit.		
	High	Last 10 or more mand. breaths ≤ set limit.		

Table 13-2: Alarm summary (cont)

Base message	Urgency	Analysis message	Remedy message	Comments
$\downarrow V_{TE\ SPONT}$ (patient data alarm)	Low	Last 2 spont breaths \leq set limit.	Check patient & settings.	Exhaled spontaneous tidal volume \leq set limit. Alarm updated whenever exhaled spontaneous tidal volume is recalculated. Possible dependent alarms: $\downarrow \dot{V}_{E\ TOT}$, $\uparrow f_{TOT}$.
	Medium	Last 4 spont breaths \leq set limit.		
	High	Last 10 or more spont breaths \leq set limit.		
$\downarrow \dot{V}_{E\ TOT}$ (patient data alarm)	Low	$\dot{V}_{E\ TOT} \leq$ set limit for $\leq 30s$.	Check patient & settings.	Total minute volume \leq set limit. Alarm updated whenever exhaled minute volume is recalculated. Possible dependent alarms: $\downarrow V_{TE\ MAND}$ $\downarrow V_{TE\ SPONT}$ $\uparrow f_{TOT}$.
	Medium	$\dot{V}_{E\ TOT} \leq$ set limit for $> 30s$.		
	High	$\dot{V}_{E\ TOT} \leq$ set limit for $> 120s$.		

Table 13-2: Alarm summary (cont)

Base message	Urgency	Analysis message	Remedy message	Comments
NO AIR SUPPLY	Low	Ventilation continues as set. Only O ₂ available.	Check air source.	Operator-set O ₂ % equals 100%. Ventilator delivers 100% O ₂ . Resets if air supply connected.
	Low	Compressor inoperative. Ventilation continues as set. Only O ₂ available.		
	High	Ventilation continues as set except O ₂ % = 100.	Check patient & air source.	
	High	Compressor inoperative. Ventilation continues as set, except O ₂ % = 100.		
NO AIR SUPPLY and NO O ₂ SUPPLY	High	No ventilation. Safety Valve Open.	Provide alternate ventilation. Check both gas sources.	Safety valve open indicator lights. Upper screen displays elapsed time without ventilator support. Safety valve closes and indicator turns off if either gas supply is connected. Individual gas supply alarm resets when corresponding supply is connected.

Table 13-2: Alarm summary (cont)

Base message	Urgency	Analysis message	Remedy message	Comments
NO O ₂ SUPPLY	Low	Ventilation continues as set. Only air available.	Check O ₂ source.	Operator-set O ₂ % equals 21%. Resets if O ₂ supply connected.
	High	Ventilation continues as set, except O ₂ % = 21.	Check patient & O ₂ source.	Operator-set O ₂ % > 21%. Ventilator delivers 21% O ₂ instead of set O ₂ %. Resets if oxygen supply connected.
O ₂ SENSOR	Low	Ventilation unaffected.	O ₂ sensor out of calibration/failure. Press 100% O ₂ CAL or INCREASE O ₂ 2 min. See page 15-TR 15-6 for more information on calibrating the oxygen sensor. replace or disable.	Background checks have detected a problem. Resets when operator successfully calibrates oxygen sensor, or disables oxygen sensor.
PROCEDURE ERROR	High	Patient connected before setup complete.	Provide alternate ventilation. Complete setup process.	Ventilator begins safety ventilation. Resets when ventilator startup procedure is complete.

Table 13-2: Alarm summary (cont)

Base message	Urgency	Analysis message	Remedy message	Comments
SCREEN BLOCK	Medium	Possible blocked beam or touch screen fault.	Remove obstruction or service ventilator.	Background checks have detected a problem. Resets when ventilator passes EST or when blockage is removed.
SEVERE OCCLUSION	High	Little/no ventilation.	Check patient. Provide alternate ventilation. Clear occlusions; drain circuit.	Ventilator enters occlusion status cycling (OSC) and upper screen displays elapsed time without ventilator support.

13.2 AC POWER LOSS alarm

The AC POWER LOSS alarm indicates the ventilator power switch is on and the ventilator is being powered by the backup power source (BPS). The ventilator annunciates a low-urgency alarm when the ventilator has been operated by the BPS for at least 3 seconds and at least 2 minutes of BPS power are available. The ventilator annunciates a medium-urgency alarm when less than 2 minutes of BPS power are estimated available.

The AC POWER LOSS alarm indicates the ventilator is being powered by the BPS and an alternate power source may soon be required to sustain normal ventilator operation. During an AC POWER LOSS condition, power to the humidifier and compressor is not available.

13.3 APNEA alarm

The APNEA alarm indicates neither the ventilator nor the patient has triggered a breath for the operator-selected apnea interval (T_A). T_A is measured from the start of an inspiration to the start of the next inspiration and is based on the ventilator's inspiratory detection criteria. T_A can only be selected via the apnea ventilation settings.

The APNEA alarm autoresets when the patient initiates two successive breaths, and is intended to establish the patient's inspiratory drive is reliable enough to resume normal ventilation. To ensure the breaths are patient-initiated (and not due to autotriggering), exhaled volumes must be at least half the V_T (this avoids returning to normal ventilation if there is a disconnect).

The ventilator monitors breathing from the start of inspiration to the start of inspiration and allows the ventilator to declare apnea when the patient fails to take a breath, rather than when he/she fails to exhale on schedule.

13.4 CIRCUIT DISCONNECT alarm

The CIRCUIT DISCONNECT alarm indicates the patient circuit is disconnected at the ventilator or the patient side of the patient wye, or a large leak is present. The methods by which circuit disconnects are detected vary depending on breath type. Time, pressure, flow, delivered volume, exhaled volume, and the D_{SENS} setting may be used in the circuit disconnect detection algorithms. See Section 10.2 on page TR 10-3 for a complete discussion of the CIRCUIT DISCONNECT detection methods.

You can set the sensitivity of the CIRCUIT DISCONNECT alarm by adjusting the D_{SENS} setting. During a CIRCUIT DISCONNECT condition, the ventilator enters idle mode and delivers a 10 L/min flow of oxygen to detect a reconnection.

When the ventilator determines the patient circuit is reconnected, the CIRCUIT DISCONNECT alarm autoresets and normal ventilation resumes without having to manually reset the alarm (for example, following suctioning).

A disconnected patient circuit interrupts gas delivery and patient monitoring. Notification of a patient circuit disconnect is crucial, particularly when the patient cannot breathe spontaneously. The ventilator does not enter apnea ventilation when a disconnect is detected to avoid changing modes during a routine suctioning procedure.

13.5 DEVICE ALERT alarm

A DEVICE ALERT alarm indicates a background test or power on self test (POST) has failed. Depending on which test failed, the ventilator either declares an alarm and continues to ventilate according to current settings, or ventilates with modified settings, or enters the ventilator inoperative state. The DEVICE ALERT alarm relies on the ventilator's self-testing and notifies you of an abnormal condition requiring service.

13.6 High circuit pressure ($\uparrow P_{PEAK}$) alarm

The $\uparrow P_{PEAK}$ alarm indicates the currently measured airway pressure is equal to or greater than the set $\uparrow P_{PEAK}$ limit. The $\uparrow P_{PEAK}$ limit is active during mandatory and spontaneous breaths, and during inspiration and exhalation. The $\uparrow P_{PEAK}$ limit is active in all normal ventilation modes. The $\uparrow P_{PEAK}$ limit is not active during a SEVERE OCCLUSION alarm.

The $\uparrow P_{PEAK}$ limit cannot be set less than:

PEEP + 7 cmH₂O, or

PEEP + P_I + 2 cmH₂O, or

PEEP + P_{SUPP} + 2 cmH₂O

nor can it be set less than or equal to $\downarrow P_{PEAK}$.

You cannot disable the $\uparrow P_{PEAK}$ limit. The ventilator phases in changes to the $\uparrow P_{PEAK}$ limit immediately to allow prompt notification of a high circuit pressure condition.

The minimum $\uparrow P_{PEAK}$ limit (7 cmH₂O) corresponds to the lowest peak pressures not due to autotriggering anticipated during a mandatory breath. The maximum $\uparrow P_{PEAK}$ limit (100 cmH₂O) was selected because it is the maximum pressure required to inflate the lungs of a patient with very low-compliance lungs.

The ventilator allows circuit pressure to rise according to a computed triggering profile for the initial phase of PC and PS breaths without activating the $\uparrow P_{PEAK}$ alarm. This triggering profile helps avoid nuisance alarms due to possible transient pressure overshoot in the airway when aggressive values of rise time % are selected. A pressure overshoot measured in the patient circuit is unlikely to be present at the carina.

The $\uparrow P_{PEAK}$ alarm is active throughout inspiration and exhalation to provide redundant patient protection (for example, to detect occlusions downstream of the pressure-sensing device).

13.7 High delivered O₂% (\uparrow O₂%) alarm

The \uparrow O₂% alarm indicates the measured O₂% during any phase of a breath is at or above the error percentage above the O₂% setting for at least 30 seconds. Although the ventilator automatically sets the \uparrow O₂% alarm limits, you can disable the oxygen sensor. (The error percentage is 12% above setting for the first hour of ventilator operation, 7% above setting after the first hour of operation, and an additional 5% above setting for the first 4 minutes following a decrease in the setting.)

The ventilator automatically adjusts the \uparrow O₂% alarm limit when O₂% changes due to 100% O₂, apnea ventilation, occlusion, circuit disconnect, or a NO AIR/O₂ SUPPLY alarm. The ventilator checks the \uparrow O₂% alarm limit against the measured oxygen percentage at 1-second intervals.

The \uparrow O₂% alarm detects malfunctions in ventilator gas delivery or oxygen monitor. The \uparrow O₂% alarm limit automatically adjusts during 100% O₂ suction, apnea ventilation, patient circuit disconnect, or low air inlet pressure because O₂% changes are expected under those circumstances. The ventilator declares a \uparrow O₂% alarm after 30 seconds to eliminate transient O₂% delivery variation nuisance alarms.

13.8 High exhaled minute volume ($\uparrow\dot{V}_{E\text{ TOT}}$) alarm

The $\uparrow\dot{V}_{E\text{ TOT}}$ alarm indicates the measured exhaled total minute volume for spontaneous and mandatory breaths is equal to or greater than the set $\uparrow\dot{V}_{E\text{ TOT}}$ limit. The $\uparrow\dot{V}_{E\text{ TOT}}$ alarm is updated whenever a new value is available.

The $\uparrow\dot{V}_{E\text{ TOT}}$ alarm can be used to detect a change in a patient's breathing pattern, or a change in compliance or resistance. The $\uparrow\dot{V}_{E\text{ TOT}}$ alarm can also detect too-large tidal volumes, which could lead to hyperventilation and hypocarbia.

The $\uparrow\dot{V}_{E\text{ TOT}}$ alarm is effective immediately upon changing the setting, to ensure prompt notification of prolonged high tidal volumes.

13.9 High exhaled tidal volume ($\uparrow V_{TE}$) alarm

The $\uparrow V_{TE}$ alarm indicates the measured exhaled tidal volume for spontaneous and mandatory breaths is equal to or greater than the set $\uparrow V_{TE}$ limit. The $\uparrow V_{TE}$ alarm is updated whenever a new measured value is available.

The $\uparrow V_{TE}$ alarm can detect increased exhaled tidal volume (due to greater compliance and lower resistance) and prevent hyperventilation during pressure control ventilation or pressure support. You can turn the $\uparrow V_{TE}$ alarm OFF to avoid nuisance alarms. (Hyperventilation due to increased compliance is not a concern during volume-based ventilation, because the tidal volume is fixed by the clinician's choice and the ventilator's compliance-compensation algorithm.)

13.10 High inspired tidal volume alarm ($\uparrow V_{TI}$, $\uparrow V_{TI}$ MAND, $\uparrow V_{TI}$ SPONT)

The high inspired tidal volume alarm indicates the patient's inspired volume exceeds the set limit. When this condition occurs, the breath terminates and the alarm sounds. The selected combination of mandatory and/or spontaneous breath type settings determines the symbol appearing in the alarm message, alarm log, and alarm settings screen. The ventilator system displays monitored inspired tidal volume values in the patient data area on the GUI screen. Table 13-3 shows the symbol corresponding to the ventilator settings in effect.

Table 13-3: Applicability of high inspired tidal volume alarm symbols

Alarm symbol	Alarm setting or patient data symbol	Mandatory or spontaneous type setting
$\uparrow V_{TI}$	V_{TI}	VC+ and TC (concurrently)
$\uparrow V_{TI}$ MAND	V_{TI} MAND	VC+
$\uparrow V_{TI}$ SPONT	V_{TI} SPONT	VS or TC

When Vent Type is NIV, there is no high inspired tidal volume alarm or setting available, but the monitored inspired tidal volume (V_{TI}) appears in the patient data area on the GUI screen.

13.11 High respiratory rate ($\uparrow f_{TOT}$) alarm

The $\uparrow f_{TOT}$ alarm indicates the measured breath rate is greater than or equal to the set $\uparrow f_{TOT}$ limit. The $\uparrow f_{TOT}$ alarm is updated whenever a new total measured respiratory rate is available.

The $\uparrow f_{TOT}$ alarm can detect tachypnea, which could indicate the tidal volume is too low or the patient's work of breathing has increased. The ventilator phases in changes to the $\uparrow f_{TOT}$ limit immediately to ensure prompt notification of a high respiratory rate condition.

13.12 INSPIRATION TOO LONG alarm

The INSPIRATION TOO LONG alarm, active only when Vent Type is INVASIVE, indicates the inspiratory time of a spontaneous breath exceeds this time limit:

$(1.99 + 0.02 \times IBW)$ seconds (adult and pediatric circuits)

$(1.0 + 0.10 \times IBW)$ seconds (neonatal circuits)

where *IBW* is the current setting for ideal body weight in kg.

When the ventilator declares an INSPIRATION TOO LONG alarm, the ventilator terminates inspiration and transitions to exhalation. The INSPIRATION TOO LONG alarm applies only to spontaneous breaths. You cannot set or disable the INSPIRATION TOO LONG alarm.

Because leaks (in the patient circuit, around the endotracheal tube cuff, or through chest tubes) and patient-ventilator mismatch can affect accurate exhalation detection, the INSPIRATION TOO LONG alarm can act as a backup method of safely terminating inspiration. If the INSPIRATION TOO LONG alarm occurs frequently, check for leaks and ensure E_{SENS} and rise time % are properly set.

13.13 Low circuit pressure alarm ($\downarrow P_{PEAK}$)

The $\downarrow P_{PEAK}$ alarm indicates the measured maximum airway pressure during the current breath is less than or equal to the set alarm level during a non-invasive inspiration or during a VC+ inspiration.

The $\downarrow P_{PEAK}$ alarm is active for mandatory and spontaneous breaths, and is present only when Vent Type is NIV or Mandatory Type is VC+. During VC+, if the PEEP level is set to 0 cmH₂O, the $\downarrow P_{PEAK}$ alarm can be turned OFF. The $\downarrow P_{PEAK}$ alarm can always be turned OFF during NIV. The $\downarrow P_{PEAK}$ alarm limit cannot be set to a value greater than or equal to the $\uparrow P_{PEAK}$ alarm limit.

Warning

Because the VC+ pressure control algorithm does not allow the target inspiratory pressure to fall below PEEP + 5 cmH₂O, attempting to set the $\downarrow P_{PEAK}$ alarm limit at or below this level will turn the alarm off.

Whenever PEEP is changed, $\downarrow P_{PEAK}$ is set automatically to its New Patient value, PEEP + 6 cmH₂O.

There are no alarms dependent upon $\downarrow P_{PEAK}$, and the $\downarrow P_{PEAK}$ alarm does not depend on other alarms.

13.14 Low delivered O₂% ($\downarrow O_2\%$) alarm

The $\downarrow O_2\%$ alarm indicates that the measured O₂% during any phase of a breath is at or below the error percentage below the O₂% setting, or less than or equal to 18%, for at least 30 seconds. Although the ventilator automatically sets the $\downarrow O_2\%$ alarm, you can disable the oxygen sensor. (The error percentage is 12% below setting for the first hour of ventilator operation, 7% below setting after the first hour of operation, and an additional 5% below setting for the first 4 minutes following a increase in the setting.)

The ventilator automatically adjusts the $\downarrow O_2\%$ alarm limit when O₂% changes due to apnea ventilation, circuit disconnect, or a NO O₂/AIR SUPPLY alarm. The $\downarrow O_2\%$ alarm is disabled during a safety valve open (SVO) condition. The ventilator checks the

↓O₂% alarm against the measured oxygen percentage at 1-second intervals.

The ↓O₂% alarm can detect malfunctions in ventilator gas delivery or the oxygen monitor, and can ensure the patient is adequately oxygenated. The ↓O₂% alarm limit is automatically adjusted during apnea ventilation, patient circuit disconnect, or low gas inlet pressures because O₂% changes are expected under those circumstances. The ventilator declares a ↓O₂% alarm after 30 seconds to eliminate nuisance alarms due to transient O₂% delivery variations. You can view the O₂% measured by the oxygen sensor by touching the More Patient Data button on the upper GUI screen.

13.15 Low exhaled mandatory tidal volume

(↓V_{TE MAND}) alarm

The ↓V_{TE MAND} alarm indicates the measured exhaled mandatory tidal volume is less than or equal to the ↓V_{TE MAND} limit. The ↓V_{TE MAND} alarm is updated whenever a new measured value of exhaled mandatory tidal volume is available.

The ↓V_{TE MAND} alarm can detect an obstruction, a leak during volume ventilation, or a change in compliance or resistance during pressure-based ventilation (that is, when the same pressure is achieved but tidal volume decreases). There are separate alarms for mandatory and spontaneous exhaled tidal volumes for use during SIMV, SPONT, and BILEVEL. The ventilator phases in a change to the ↓V_{TE MAND} alarm immediately to ensure prompt notification of a low exhaled tidal volume condition.

13.16 Low exhaled spontaneous tidal volume

(↓V_{TE SPONT}) alarm

The ↓V_{TE SPONT} alarm indicates the measured exhaled spontaneous tidal volume is less than or equal to the ↓V_{TE SPONT} limit. The ↓V_{TE SPONT} alarm is updated whenever a new measured value of exhaled spontaneous tidal volume is available.

The ↓V_{TE SPONT} alarm can detect a leak in the patient circuit or a change in the patient's respiratory drive during a single breath.

The $\downarrow V_{TE\ SPONT}$ alarm is based on the current breath rather than on an average to detect changes as quickly as possible. There are separate alarms for mandatory and spontaneous exhaled tidal volumes for use during SIMV. The ventilator phases in a change to the $\downarrow V_{TE\ SPONT}$ alarm limit immediately to ensure prompt notification of a low exhaled tidal volume condition.

13.17 Low exhaled total minute volume ($\downarrow \dot{V}_{E\ TOT}$) alarm

The $\downarrow \dot{V}_{E\ TOT}$ alarm indicates the measured minute volume (for mandatory and spontaneous breaths) is less than or equal to the set $\downarrow \dot{V}_{E\ TOT}$ limit. The $\downarrow \dot{V}_{E\ TOT}$ alarm is updated whenever a new value for exhaled minute volume is calculated. You cannot turn off the $\downarrow \dot{V}_{E\ TOT}$ alarm.

The $\downarrow \dot{V}_{E\ TOT}$ alarm can detect a leak or obstruction in the patient circuit, a change in compliance or resistance, or a change in the patient's breathing pattern. The $\downarrow \dot{V}_{E\ TOT}$ alarm can also detect too-small tidal volumes, which could lead to hypoventilation and hypoxia (oxygen desaturation).

The ventilator phases in changes to the $\downarrow \dot{V}_{E\ TOT}$ alarm limit immediately to ensure prompt notification of prolonged low tidal volumes.

13.18 PROCEDURE ERROR alarm

The ventilator declares a PROCEDURE ERROR alarm if ventilator is powered up (either by turning on the power switch or following a power loss of at least 5 minutes) and detects a patient attached before Ventilator Startup has been completed. Until ventilator settings are confirmed, the ventilator annunciates a high-urgency alarm and enters safety ventilation.

The PROCEDURE ERROR alarm is intended to require you to confirm ventilator settings whenever ventilator power is restored, in case a new patient is attached to the ventilator. Safety ventilation is an emergency mode of ventilation providing ventilation according to displayed settings until you have confirmed ventilator settings, and is not intended for long-term patient ventilation.

This page is intentionally blank.

Patient data

Chapter 14 provides supplementary information about selected patient data displayed on the Puritan Bennett™ 840 Ventilator System's graphic user interface (GUI). For ranges, resolutions, and accuracies of all patient data displays, see Table A-15 on page OP A-53.

The ventilator displays patient data on the upper GUI screen. Under-range or over-range patient data flashes the minimum or maximum value. Alarm reset has no effect on patient data collection. Patient data based on one-minute averaging is reset if you change a ventilator setting directly affecting that information.

14.1 Delivered O₂%

The ventilator measures the percentage of oxygen in the gas at the ventilator outlet, upstream of the inspiratory filter. Delivered O₂% is displayed on the GUI in the *More Patient Data* screen. Delivered O₂% is used to detect ↑O₂% and ↓O₂% alarms.

The delivered O₂% parameter independently checks the O₂% setting. The delivered O₂% measurement monitors the O₂% at the ventilator (*not* the O₂% delivered to the patient). If the oxygen mix is affected downstream of the inspiratory filter (for example, by nebulization), delivered O₂% does *not* reflect that change. Delivered O₂% is measured upstream of the inspiratory filter to avoid having to sterilize the oxygen sensor.

The measurement range is the full range of possible percentages, including cases where the oxygen percentage is actually lower than the 21% found in room air (as could be the case if gas supplies function improperly).

14.2 End expiratory pressure (PEEP)

PEEP is the pressure measured at the end of the exhalation phase of the just completed breath, whether mandatory or spontaneous. PEEP is updated at the beginning of the inspiratory phase. If expiratory pause is active, PEEP may reflect the lung PEEP level.

PEEP is the last value of the low-pass filtered airway pressure during exhalation when the expiratory pause maneuver is active. Otherwise, PEEP is the last low-pass filtered value when flow has reached 0.5 L/min, or when a mandatory breath has interrupted exhalation, whichever occurs first. The accuracy of the PEEP measurement is relative to pressure measured at the exhalation side of the patient wye.

PEEP can be useful for making lung PEEP assessments using the EXP PAUSE key. The ventilator measures PEEP when expiratory flow has reached 0.5 L/min, or when exhalation has been interrupted by a mandatory breath, to avoid measuring a patient trigger.

14.3 End inspiratory pressure ($P_{I\text{ END}}$)

$P_{I\text{ END}}$ is the pressure measured at the end of the inspiratory phase of the current breath, whether mandatory or spontaneous. $P_{I\text{ END}}$ is updated at the beginning of the exhalation phase. The ventilator displays negative $P_{I\text{ END}}$ values. If plateau is active, the $P_{I\text{ END}}$ display indicates the pressure at the end of the plateau.

$P_{I\text{ END}}$ is the last value in inspiration of the low-pass filtered airway pressure. The accuracy of the $P_{I\text{ END}}$ measurement is relative to the patient wye for pressure control (PC) breaths with inspiratory times of 1 second or longer.

For volume-based breaths, $P_{I\text{ END}}$ is usually the same as peak circuit pressure (P_{PEAK}). For pressure-based breaths, $P_{I\text{ END}}$ is more indicative of the pressures actually exerted on the lungs (P_{PEAK} , on the other hand, only shows a pressure spike and is not as meaningful for pressure ventilation). The $P_{I\text{ END}}$ is the plateau pressure when a plateau follows mandatory breath delivery. Plateau pressure can be used to compute lung compliance (stiffness) and resistance to flow. Plateaus are also delivered to overcome blockages, to ventilate under-inflated lungs, and to

improve gas distribution. Plateau pressure is measured after pressure equilibrates. With a small airway in place, the pressure difference due to equilibration can be as much as 20 cmH₂O.

The displayed range includes low pressures that can occur when the patient “out-draws” the ventilator and the high pressures in low-compliance patients. The 130 cmH₂O maximum allows the ventilator to measure pressure overshoots of breaths truncated at the maximum high pressure limit (100 cmH₂O).

14.4 Exhaled minute volume ($\dot{V}_{E\text{ TOT}}$)

$\dot{V}_{E\text{ TOT}}$ is an estimate of the sum of volumes exhaled for mandatory and spontaneous breaths over the previous one-minute interval. $\dot{V}_{E\text{ TOT}}$ is BTPS- and compliance-compensated.

During the first minute of operation following power-up or a change to respiratory rate (f) or tidal volume (V_T) settings, $\dot{V}_{E\text{ TOT}}$ is updated at the beginning of each new inspiration or at ten-second intervals, whichever comes first. The ventilator uses this formula to compute $\dot{V}_{E\text{ TOT}}$ based on up to eight breaths:

$$\dot{V}_{E\text{ TOT}} = 60 \times (\text{total } V_T \text{ in } t \text{ seconds})/t$$

where t is the time in seconds since the computation started.

After the first minute, the ventilator computes $\dot{V}_{E\text{ TOT}}$ based on up to eight mandatory and spontaneous exhaled tidal volumes occurring in the past 60 seconds, and updates the computation at the beginning of the next inspiration or the next ten-second interval, whichever comes first. However, if the next inspiration occurs within 0.5 second of the last update, the computation is not updated at that time.

The $\dot{V}_{E\text{ TOT}}$ computation is based on full and partial breaths that occurred during the preceding one-minute period. If the one-minute period includes a partial breath, then the interval is extended to include the entire breath, and the sum of all tidal volumes over this extended interval is normalized to one minute.

For example, if eight full breaths and part of a ninth breath occur in the last minute, $\dot{V}_{E\text{ TOT}}$ would be the sum of the nine full breaths normalized by this ratio:

60 : (the number of seconds in the extended interval)

If the patient stops breathing, $\dot{V}_{E\text{ TOT}}$ continues to be updated every ten seconds, and automatically decrements.

14.5 Exhaled tidal volume (V_{TE})

V_{TE} is the volume exhaled from the patient's lungs for a mandatory or spontaneous breath. It is computed by integrating the net flow over the expiratory period, then compliance- and BTPS-compensating that value. The V_{TE} is computed based on a five-breath average. It is updated at the beginning of the next inspiratory phase.

V_{TE} is a basic indicator of the patient's ventilatory capacity and can be an indicator of the accuracy of the tidal volume setting for mandatory breaths.

14.6 I:E ratio (I:E)

I:E is the ratio of inspiratory time to expiratory time of any breath (mandatory and spontaneous), whether volume- or pressure-based. I:E is updated at the beginning of every inspiratory phase and is computed breath-to-breath (the value is not filtered).

The I:E ratio is a fundamental parameter indicating whether a patient's breathing pattern is normal and is displayed according to respiratory care convention.

14.7 Intrinsic (auto) PEEP ($PEEP_I$) and total PEEP ($PEEP_{TOT}$)

$PEEP_{TOT}$ and $PEEP_I$ are determined during an operator-initiated expiratory pause, in which the PSOL valves and exhalation valves are closed. $PEEP_{TOT}$ is the pressure measured during the pause maneuver. It is an estimate of the total pressure at the end of exhalation, referenced to atmosphere. $PEEP_I$ is an estimate of the pressure above the PEEP level at the end of exhalation.

During the pause, the most recently selected graphics are displayed and frozen, so you can follow and assess when expiratory pressure stabilizes.

14.8 Mean circuit pressure (P_{MEAN})

P_{MEAN} is the average circuit pressure, for an entire breath cycle, including both inspiratory and expiratory phases (whether the breath is mandatory or spontaneous). The ventilator displays negative P_{MEAN} values. The P_{MEAN} display is updated at the beginning of each inspiration.

The ventilator computes P_{MEAN} by averaging all pressure measurements made through an entire breath cycle. Accuracy is relative to pressure measured at the exhalation side of the patient wye and is based on the accuracy of the circuit pressure measurement.

14.9 Peak circuit pressure (P_{PEAK})

P_{PEAK} is the maximum pressure measured during the inspiratory phase of the current mandatory or spontaneous breath and is updated at the end of each inspiration. The ventilator displays negative P_{PEAK} values. The ventilator displays the most positive value of the low-pass filtered airway pressure measured during the inspiratory phase.

P_{PEAK} can be used to evaluate trends in lung compliance and resistance. For volume-based breaths, P_{PEAK} is usually the same as end inspiratory pressure ($P_{I\ END}$). For pressure-based breaths, $P_{I\ END}$ is more indicative of the pressures actually exerted on the lungs (P_{PEAK} , on the other hand, may only show a pressure spike and may not be meaningful for pressure ventilation).

The minimum displayed range includes low pressures found when the patient “out-draws” the ventilator. The maximum displayed value allows the ventilator to display the high pressures in low-compliance patients and pressure overshoots of breaths truncated at the maximum high pressure limit (100 cmH₂O).

14.10 Plateau pressure (P_{PL})

P_{PL} is the pressure measured in the ventilator breathing circuit at the end of an inspiratory pause maneuver. Because the pause maneuver is conducted with the ventilator breathing circuit sealed (PSOL valves and exhalation valve closed and assuming a leak-tight system), P_{PL} is the best estimate of the pressure in the patient’s lungs.

Beginning with the start of the pause maneuver, P_{PL} is displayed and updated continuously. At the end of the maneuver P_{PL} , along with the other pause data, is “frozen,” enabling you to view all of the data together. Pressing “UNFREEZE” causes the data to be discarded.

14.11 Spontaneous minute volume ($\dot{V}_{E\ SPONT}$)

$\dot{V}_{E\ SPONT}$ is the sum of spontaneous exhaled volumes, normalized to one minute. The displayed $\dot{V}_{E\ SPONT}$ is compliance- and BTPS-compensated. As more mandatory breaths are delivered, the displayed $\dot{V}_{E\ SPONT}$ is computed and updated whenever $\dot{V}_{E\ TOT}$ is computed and updated. The computation for $\dot{V}_{E\ SPONT}$ is the same as for $\dot{V}_{E\ TOT}$, except only spontaneous breaths are included, and the one-minute interval is not extended unless the partial breath is a spontaneous breath. (See exhaled minute volume for details.)

$\dot{V}_{E\text{ SPONT}}$ can help determine how much ventilation takes place solely due to spontaneous breathing, and does not include patient-initiated mandatory breaths. Minute volume establishes a patient's ventilatory adequacy, and $\dot{V}_{E\text{ SPONT}}$ indicates how much of total ventilation is due to the patient's efforts. $\dot{V}_{E\text{ SPONT}}$ can be used to assess whether a patient being ventilated in SIMV is ready to be weaned.

14.12 Static compliance and resistance (C_{STAT} and R_{STAT})

C (or C_{STAT} , static compliance) is an estimate of the elasticity of the patient's lungs; it is expressed in mL/cmH₂O. R (or R_{STAT} , static resistance) is the total inspiratory resistance across the artificial airway and respiratory system. It is an estimate of how restrictive the patient's airway is, based on the pressure drop at a given flow; it is expressed in cmH₂O/L/second. These values are computed during an operator-initiated inspiratory pause, in which the PSOL valves and exhalation valve are closed. C_{STAT} is computed during a mandatory breath. R_{STAT} is computed during a VC mandatory breath with a square waveform.

C_{STAT} is computed from this equation:

$$C_{\text{STAT}} = \frac{V_{\text{EXH}}}{P_{\text{PL END}} - \text{PEEP}} - C_{\text{C}}$$

where: V_{EXH} is the total expiratory volume (patient and breathing circuit)

$P_{\text{PL END}}$ is the pressure in the patient circuit measured at the end of the 100-ms interval that defines the pause-mechanics plateau

PEEP is the pressure in the patient circuit measured at the end of exhalation

C_{C} is the compliance of the Ventilator Breathing System (VBS) during the pause maneuver (derived from SST)

R_{STAT} is computed from this equation once C_{STAT} is computed (assuming the breath type was VC with square flow waveform):

$$R_{STAT} = \frac{\left[1 + \frac{C_C}{C_{STAT}}\right] (P_{PEAK} - P_{PL\ MID})}{\dot{V}_{PAT}}$$

where: C_C is as given above

C_{STAT} is as given above

$P_{PL\ MID}$ is the mean pressure in the patient circuit over the 100-ms interval that defines the pause-mechanics plateau

P_{PEAK} is the pressure in the patient circuit at the end of the square flow waveform

\dot{V}_{PAT} is the flow into the patient during the last 100 ms of the waveform

During the pause, the most recently selected graphics are displayed and frozen, so you can see when inspiratory pressure stabilizes. C_{STAT} and R_{STAT} are displayed at the start of the next inspiration following the inspiratory pause. They take this format:

C_{STAT} xxx

or

R_{STAT} yyy

If the software determines variables in the equations or the resulting C_{STAT} or R_{STAT} values are out of bounds, it identifies the questionable C_{STAT} and R_{STAT} values with special formatting and text messages:

- Parentheses () signify questionable C_{STAT} or R_{STAT} values, derived from questionable variables.
- Flashing C_{STAT} or R_{STAT} values are out of bounds.
- Asterisks (*****) mean variables fall below noise-level bounds.
- R_{STAT} ----- means resistance could not be computed, because the breath was not of a mandatory, VC type with square flow waveform.

Refer to Table 14-1 for further troubleshooting.

Table 14-1: Inspiratory pause maneuver displays

Compliance (C _{STAT})	Resistance (R _{STAT}) (if displayed)	Meaning	Corrective action
C _{STAT} (*****)	R _{STAT} (*****)	C _{STAT} < 0.1 mL/cmH ₂ O or patient flow < 0.1 L/min. The low patient flow is below the threshold of reliable measurement. Both C _{STAT} and R _{STAT} are questionable.	Check the breathing waveforms and monitored patient data for underlying cause.
C _{STAT} (*****)	R _{STAT} (*****)	The difference in pressure between end plateau and end exhalation < 0.1 cmH ₂ O; below the limits of reliable resolution. Both C _{STAT} and R _{STAT} are questionable.	Check the breathing waveforms and monitored patient data for underlying cause.
C _{STAT} (0) or C (500)	R _{STAT} () <i>Message as dictated by other tests</i>	C _{STAT} ≤ 0 mL/cmH ₂ O or C _{STAT} > 500 mL/cmH ₂ O. These measurements are outside of physiological limits.	Check the patient-ventilator interaction, the breathing waveforms, and the patient circuit for underlying causes.
C _{STAT} () <i>Message as dictated by other tests</i>	R _{STAT} (0) or R _{STAT} (500)	R _{STAT} ≤ 0 cmH ₂ O/L/s or R _{STAT} > 500 cmH ₂ O/L/s. These measurements are outside of physiological limits.	Check the patient-ventilator interaction, the breathing waveforms, and the patient circuit for underlying causes.

Table 14-1: Inspiratory pause maneuver displays (cont)

Compliance (C _{STAT})	Resistance (R _{STAT}) (if displayed)	Meaning	Corrective action
C _{STAT} (xxx)	R _{STAT} (yyy) Sub-threshold input value(s)	C _{STAT} < 1/3 of ventilator breathing system compliance (derived from SST). Both C _{STAT} and R _{STAT} are questionable.	If the patient's IBW ≤ 24 kg, consider installing a pediatric patient circuit.
C _{STAT} (xxx) Incomplete exhalation	R _{STAT} (yyy) Incomplete exhalation	Exhalation was not complete. End-expiratory pressure and total exhaled flow values are questionable.	Check for an insufficient expiratory interval. If possible, shorten inspiration time and reduce respiratory rate.
C _{STAT} (xxx) No plateau	R _{STAT} (yyy) No plateau	Plateau is not "flat" (lung and circuit pressures did not equilibrate) or pause pressure was excessively noisy. Both C _{STAT} and R _{STAT} are questionable.	If plateau continues to decline, check for a leak in the breathing circuit, possibly around the cuff. If plateau is unstable, check circuit for moisture condensation or movement.
C _{STAT} (xxx) Out of range	R _{STAT} (yyy) Questionable measurement	C _{STAT} < 1.0 mL/cmH ₂ O. This results from questionable input data. The value for R _{STAT} is also questionable.	Check the breathing waveforms and monitored patient data for underlying cause.
		C _{STAT} > 100 mL/cmH ₂ O. This results from questionable input data. The value for R _{STAT} is also questionable.	Check the breathing waveforms and monitored patient data for underlying cause.

Table 14-1: Inspiratory pause maneuver displays (cont)

Compliance (C _{STAT})	Resistance (R _{STAT}) (if displayed)	Meaning	Corrective action
C _{STAT} (xxx) Questionable measurement	R _{STAT} (yyy) Out of range	R _{STAT} > 150 cmH ₂ O/L/s. This results from questionable input data, possibly C _{STAT} .	Check the breathing waveforms and monitored patient data for underlying cause.
C _{STAT} (xxx) Questionable measurement	R _{STAT} (yyy) Questionable measurement	The pressure rose slowly at the end of the square flow waveform. This suggests the pressures, volumes, and flows involved are minimal and questionable. This is not expected during normal ventilation.	Check the pressure-time waveform to see whether the patient delayed inspiration until the end of gas delivery.
C _{STAT} (xxx) Sub-threshold input value(s)	R _{STAT} (yyy) Questionable measurement	The difference between the circuit pressure at the end of the plateau and the pressure at the end of exhalation < 0.5 cmH ₂ O. The value for R _{STAT} is questionable.	Check for a highly compliant lung, inflated slightly. If safe to do so, increase tidal volume.

Table 14-1: Inspiratory pause maneuver displays (cont)

Compliance (C_{STAT})	Resistance (R_{STAT}) (if displayed)	Meaning	Corrective action
NA	R_{STAT} (yyy) Out of range	$R_{STAT} < 0.5$ cmH ₂ O/L/s. This results because the patient flow or the pressure difference from peak to plateau is questionable.	Check the breathing waveforms and monitored patient data for underlying causes.
	R_{STAT} (yyy) Questionable measurement	The pressure rose too quickly at the end of the square flow waveform. This suggests poor patient-ventilator synchrony and the lung was very stiff or the flow very high. The value for R_{STAT} is questionable.	If the patient's condition permits, consider reducing the set tidal volume and/or increasing the inspiratory time (equivalent to reducing the peak flow). Check the pressure-time waveform to see whether the patient may have triggered the mandatory breath, then relaxed toward the end of inspiration.
	R_{STAT} (yyy) Subthreshold input value(s)	The difference between the circuit pressure at the end of the square flow waveform and at the end of the plateau < 0.5 cmH ₂ O. The value for R_{STAT} is questionable.	Check for: low patient flow through a relatively large-diameter artificial airway, low absolute flow and a relatively long inspiratory time, or a small patient connected to a breathing circuit with a relatively large compliance.

Table 14-1: Inspiratory pause maneuver displays (cont)

Compliance (C _{STAT})	Resistance (R _{STAT}) (if displayed)	Meaning	Corrective action
NA		Patient flow < 20 L/min and C _{STAT} < 4 mL/cmH ₂ O. The value for R _{STAT} is questionable.	Check for: low patient flow through a relatively large-diameter artificial airway, low absolute flow and a relatively long inspiratory time, or a small patient connected to a breathing circuit with a relatively large compliance.

14.13 Total respiratory rate (f_{TOT})

f_{TOT} is the number of breaths delivered to a patient normalized to one minute, whether mandatory or spontaneous, and is updated at the beginning of each inspiratory phase.

During the first minute of operation after a power-up or after a change to any setting affecting the rate of mandatory breath delivery, the system updates f_{TOT} at the beginning of each inspiration. The ventilator uses this formula to compute f_{TOT} based on up to eight breaths (or 16 breaths when Spontaneous Type is PA):

$$\text{Startup } f_{\text{TOT}} = \frac{60 \times (\text{total number of inspirations in } t)}{t}$$

where t is the time in seconds since the computation started.

After the first minute, the ventilator computes f_{TOT} based on up to eight breaths initiated during the last minute and updates the computation at the beginning of the next inspiration or the next ten-second interval, whichever comes first. However, if the next inspiration occurs within 0.5 second of the last update, the computation is not updated at that time.

Except for the start-up calculation and the ten-second interval, f_{TOT} is calculated based on a whole number of breaths. Therefore, the 60-second interval is extended to include the next breath initiation. The ventilator uses this formula to calculate the f_{TOT} :

$$\text{Post-startup } f_{TOT} = \frac{\text{total whole number of breaths in } 60 \text{ s} + x}{60 \text{ s} + x}$$

where x is the number of seconds the 60-second interval was extended to include the next inspiration.

f_{TOT} is one of the most sensitive parameters of respiratory function and is an important indicator of ventilatory adequacy. The displayed range can apply where no breaths are delivered to the patient within the last minute, or when the patient is receiving the maximum respiratory rate possible.

Safety net

The ventilator's *safety net strategy* refers to how the Puritan Bennett™ 840 Ventilator System responds to patient problems and system faults.

- *Patient problems* are declared when patient data is measured equal to or outside of alarm thresholds and are usually self-correcting or can be corrected by a practitioner. The alarm monitoring system detects and announces patient problems. Patient problems do not compromise the ventilator's performance.
- *System faults* include hardware faults (those that originate inside the ventilator and affect its performance), soft faults (faults momentarily introduced into the ventilator that interfere with normal operation), inadequate supply (AC power or external gas pressure), and patient circuit integrity (blocked or disconnected circuit). System faults are not usually self-correcting and are handled under the assumption they can affect the ventilator's performance. "System" refers to the ventilator, external gas and power supplies, and the machine-patient interconnections.

The ventilator is designed to alarm and provide the highest level of ventilation support possible in case of ventilator malfunction. If the ventilator is not capable of ventilatory support, it opens the patient circuit and allows the patient to breathe from room air (this emergency state is called *safety valve open*, SVO). Safety mechanisms are designed to be verified periodically or have redundancy. The ventilator is designed to ensure a single-point failure does not cause a safety hazard or affect the ventilator's ability to annunciate a high-urgency audible alarm.

15.1 Patient problems

In case of patient problems, the ventilator remains fully operative and annunciates the appropriate alarm. The patient problem determines the detection, response, and urgency of each alarm.

15.2 System faults

The ventilator is designed to prevent system faults. The ventilator is modular, and it allows the breath delivery unit (BDU) to operate independently of the graphic user interface (GUI) or other subsystems not related to breath delivery. If the ventilator detects a system fault and ventilation can continue, it alarms and provides ventilatory support as close to the current settings as possible, depending on the specific system fault. Most system faults are DEVICE ALERT alarms, and can be high-, medium-, or low-urgency alarms.

The ventilator uses these strategies to detect system faults:

- *Ongoing background checks* and *hardware monitoring circuitry* function during normal operation.
- *Power on self test (POST)* checks the system at power-up.
- *Short self test (SST)* and *extended self test (EST)* check the ventilator when a patient is not attached to the ventilator.

If the ventilator cannot provide reliable ventilatory support and fault monitoring, then the ventilator alarms and enters the SVO emergency state. During SVO, the ventilator de-energizes the safety, exhalation, and inspiratory valves, annunciates a high-urgency alarm, and turns on the SVO indicator.

During SVO, a patient can spontaneously inspire room air and exhale. Check valves on the inspiratory and expiratory sides minimize rebreathing exhaled gas during SVO. During SVO the ventilator:

- Displays the elapsed time without ventilatory support.
- Does *not* display patient data (including waveforms).
- Does not detect patient circuit occlusion or disconnect conditions.

15.3 Ongoing background checks

Ongoing background checks assess the ventilator's electronics and pneumatics hardware continuously during ventilation, and include:

- *Periodically initiated tests:* Tests initiated at intervals of a specified number of machine cycles. These tests check the hardware components directly affecting the breath delivery system, safety mechanisms, and user interface. These tests detect and correct data corruption of control variables.
- *Boundary checks:* Checks performed at every analog measurement. Boundary checks verify measuring circuitry, including sensors.
- *CPU cross-checks:* The ventilator's GUI central processing unit (CPU) monitors the BDU CPU's activity. Cross-checks provide independent verification that each processor is functional. They focus on circuit pressure, breath periodicity, length of inspiration, alarm annunciation, oxygen percentage, and ventilator settings. Communications errors between CPUs are detected and corrected.

Specific background checks include:

- *Memory tests:* RAM (parity-check only), ROM, and nonvolatile memory (NOVRAM) are tested (without corrupting data stored in memory) on an ongoing basis.
- *Analog-to-digital converter (ADC) reasonability checks:* Flow sensors, thermistors, and pressure sensors are checked against predetermined ranges to ensure proper functioning of the system's analog measuring capability and transducers.
- *Voltage calibration check:* The ventilator reads the system reference voltage through the ADCs, then uses this reference voltage to scale all analog measurements.
- *Digital-to-analog converter (DAC) and ADC circuitry checks:* Signals from both the expiratory and inspiratory DAC are fed back to the microprocessor through the ADC, and the original DAC input value is compared to the converted ADC signal.
- *Power supply voltage checks:* The ventilator periodically checks system voltages (+12, +15, -15, and +5 V DC), battery voltage, and the cable and voltage of the speaker.

- *Pressure transducers:* The ventilator periodically checks to ensure transducer drift doesn't exceed system accuracy limits.
- *Touch screen checks:* The ventilator checks for failures in the touch screen system, including optical obstruction of one or more LED/photodiode pair.
- *Offscreen keys:* The ventilator checks for key stuck.
- *SmartAlert audio annunciation system (SAAS):* The ventilator verifies the SAAS can annunciate alarms properly.
- *Options:* The ventilator periodically checks for the existence of any options, its pass/fail status, and whether or not the option is active. The results of whatever checks an option performs on itself are reported to the BDU and GUI CPUs.

If any of these background tests detects a fault, the ventilator alarms and provides the most appropriate level of ventilatory support consistent with the detected system fault.

15.4 Hardware monitoring circuitry

The ventilator has hardware circuitry dedicated to monitoring software activity and power failure problems. The ventilator also has monitoring circuitry built into the CPU.

- *Watchdog (WD) time-out circuitry:* WD time-out circuitry monitors software activity and indicates if software is executed irregularly. WD circuitry is independent of the CPUs and software. In case of irregular software execution, WD circuitry invokes POST. If POST does not confirm an error, the ventilator returns to normal operation to minimize the interruption to normal breath delivery. If three WD time-outs occur within 24 hours, the ventilator alarms and declares a ventilator inoperative state.
- *Bus time-out monitoring circuitry:* Bus time-out circuitry is independent of the CPU and monitors whether any bus activity has taken place for a predetermined time. If no bus activity is detected, bus time-out circuitry invokes POST. If POST does not confirm an error, the ventilator returns to normal operation to minimize the interruption to normal breath delivery. If three bus time-outs occur within 24 hours,

the ventilator alarms and declares a ventilator inoperative state.

- *Built-in CPU monitoring circuitry:* Mechanisms are built into the CPU to detect out-of-boundary operation and detect system faults. If the CPU circuitry detects a problem, the ventilator alarms, the CPU resets, and the ventilator provides the highest level of ventilatory assistance possible.
- *Power fail monitoring:* The power fail module monitors the DC power supply. When the power switch is ON and +5 V is out of range ± 0.25 V, the ventilator locks access to RAM, enters SVO, closes the proportional solenoid valves (PSOLs), and turns on the ventilator inoperative indicator and audio alarm. Ventilator alarms monitor AC power.

15.5 Power on self test (POST)

POST checks the integrity of the ventilator's electronic hardware whenever it is powered up. POST detects system faults without operator intervention.

15.6 Short self test (SST)

SST is designed to be performed when the patient circuit or humidification system is changed. SST primarily tests the patient circuit for leaks, calibrates the patient circuit, and measures the resistance of the expiratory filter. SST requires minimal operator participation and no external test equipment.

15.7 Extended self test (EST)

EST performs a more thorough system test than POST or SST, and is also intended to detect system faults. EST requires operator participation, but no external test equipment other than the "gold standard" circuit (the test circuit designed for use with EST). EST can also serve as a confidence check following repair or a temporary problem.

15.8 Oxygen sensor calibration

The ventilator performs a single-point oxygen sensor calibration during the 100% suctioning procedure (that is, when you press the 100% O₂/CAL 2 min key or INCREASE O₂ 2 min key), allowing you to calibrate the oxygen sensor frequently without having to disconnect the patient. If the oxygen sensor calibration fails, the ventilator declares an O₂ SENSOR alarm that resets when the ventilator successfully calibrates the oxygen sensor. The ventilator's oxygen sensor is always active unless you disable it. The 100% O₂ calibration function can be initiated from the INCREASE O₂ 2 min key if the O₂ setting is 80% or above if you are using the NeoMode software option, or from the **More Settings** screen, at any oxygen concentration.

To perform an oxygen sensor calibration from the **More Settings** screen:



1. Touch the OTHER SCREENS button on the lower GUI, then touch the MORE SETTINGS button.
2. Touch the O₂ sensor button and turn the knob to select Calibration, and press ACCEPT. The progress indicator appears on the screen. The O₂ sensor setting will remain at the setting that existed before calibration (Disabled or Enabled).

During Oxygen Sensor calibration, the INCREASE O₂ 2 min LED is turned OFF.

15.9 Exhalation valve calibration

The exhalation valve calibration, available in service mode, builds a table of digital-to-analog (DAC) commands corresponding to expiratory pressure levels.

15.10 Ventilator inoperative test

The ventilator inoperative test, available in service mode, verifies the ventilator is capable of establishing the ventilator inoperative state. This test verifies the two redundant ventilator inoperative commands separately and ensures each command establishes a ventilator inoperative state.

15.11 Flow sensor offset calibration

This function, available in service mode, calibrates the offsets out of the exhalation flow sensor (relative to the air and oxygen flow sensors).

15.12 Atmospheric pressure transducer calibration

This function, available in service mode, calibrates the atmospheric pressure transducer using an external barometer.

This page is intentionally blank.

Power on self test (POST)

POST tests the integrity of the Puritan Bennett™ 840 Ventilator System's electronic subsystem without operator intervention. It executes when the ventilator powers up, before it enters service mode, or if the ventilator detects selected fault conditions. A full-length POST takes under ten seconds (from power on until Ventilator Startup begins).

The graphic user interface (GUI) and the breath delivery unit (BDU) subsystems each has its own POST that tests the major hardware electronics systems. POST does not check the ventilator's pneumatics, options, or accessories not directly related to ventilation. POST is designed to detect major problems before proceeding to normal ventilation, and to provide a confidence check before a patient is connected to the ventilator.

POST routines are ordered so each routine requires successively more operational hardware than the last. This sequence allows POST to systematically exclude electronic components as causes of system malfunctions.

16.1 Safety

The ventilator does not provide ventilatory support to the patient during POST. The ventilator alarms if POST lasts longer than ten seconds or if an unexpected fault is detected. POST is designed to minimize the delay until normal ventilation begins and to provide immediate notification in case a fault is detected. The ventilator runs a short version of POST after recovering from a brief power loss.

When a compressor is installed and wall air is not present, there may be a short interval following a successful POST before the compressor achieves operational pressures. If so, the ventilator annunciates a NO AIR SUPPLY alarm, which resets as soon as the compressor charges the system to operational pressure.

16.2 POST characteristics

Each processor in the ventilator runs its own POST. Upon completion, each processor reports its test results to the GUI processor. POST starts with the software kernel, then tests the hardware that directly interfaces to the kernel. POST then tests the rest of the hardware. Hardware linked to each processor through a communication channel is checked once the communication link is verified.

The main characteristics of POST are:

- The kernel of every subsystem is designed to include the smallest number of components possible, and each kernel can run independently of the rest of the system.
- POST verifies system integrity by checking that all main electrical connectors are correctly attached and that interfaces to all electronic subsystems (such as the keyboard or audible alarm) are functional. POST performs all electrical hardware checks that do not require operator intervention.
- POST checks safety hardware, such as the watchdog circuitry and bus time-out monitoring circuitry.
- POST's memory test preserves all data necessary to determine ventilator settings and initializes the remaining memory to a predefined state.
- POST can determine what event initiated POST.
- Any other processors in the system initiates its own POST and reports the test results to the host processor.

To ensure there is an alarm if the central processing unit (CPU) fails, audio, visual, and remote alarms are normally on, and turn off once system initialization (that is, the process that occurs between POST completion and the start of ventilation) is completed and communication is established.

An alarm turns on if POST lasts more than ten seconds or if POST restarts three times without completion. The ten-second timer is a redundant check in case POST fails to alarm upon detecting a fault. The check for three restarts can detect a continuous loop, and prevents breath delivery from being interrupted for more than ten seconds.

During POST, the ventilator proportional solenoid valves (PSOLs) are closed and the exhalation valve and safety valve are open to allow the patient to breathe room air.

Once POST is complete, ventilator startup (following power-up or a power interruption of longer than 5 minutes) or normal ventilation begins, unless service mode is requested or the ventilator detects any of the following:

- An uncorrected major system fault.
- An uncorrected major POST fault.
- An uncorrected short self test (SST) failure or non-overridden SST alert.
- An uncorrected extended self test (EST) failure or non-overridden EST alert.
- The ventilator is turned on for the first time following a software download, but has not yet successfully completed one of the following: exhalation valve calibration, SST, or EST.
- An uncompleted system initialization.

16.3 POST following power interruptions

The ventilator executes a normal POST following a long power interruption (five minutes or more) while the power switch is on. The ventilator runs a full POST after a long power interruption under the assumption the patient would have been disconnected and ventilated by other means, and because circumstances that cause a lengthy power loss warrant a full POST.

The ventilator runs a short POST (which tests the BDU only) if power is interrupted for less than five minutes. After a short power interruption (during which the status of the patient cannot be assumed), the ventilator resumes normal ventilation as soon as possible, in case the patient remains connected. Running a short POST (three seconds or less from return of AC power to beginning breath delivery) allows for short power interruptions due to common events (for example, switching to generator power) that do not require a normal POST, and assumes a patient may still be connected to the ventilator. Short POST checks the software kernel, verifies checksums for code, and determines what event invoked POST.

16.4 POST fault handling

How the ventilator handles a POST failure depends on which test has failed and whether the failure occurred during the kernel test. Fault information is logged in nonvolatile random access memory (NOVRAM) and is time-stamped. POST failures are classified as *minor* or *major faults*:

Minor POST fault: A fault not affecting ventilation or patient safety checks. Normal ventilation is allowed to begin if POST detects a minor fault. A minor fault does not interrupt the regular POST sequence. The ventilator displays POST fault information and logs it into NOVRAM.

Major POST fault: A fault affecting ventilation or patient safety checks. A major fault interrupts the regular sequence of POST. Fault information is sent to the GUI (if possible) and to a set of discrete visual indicators on the GUI and BDU. The ventilator logs major fault information into NOVRAM, if possible, and sends a command to turn on audio, visual, and remote alarms. The safety valve and exhalation valve remain open to allow the patient to breathe room air. The ventilator cannot execute GUI and BDU software until it passes POST.

16.5 POST system interface

POST is the first process to run when the ventilator turns on. Breath delivery cannot start until the ventilator completes POST with no major POST faults, and until no major system, SST, or EST faults exist. Once POST starts, the ventilator opens the safety valve and exhalation valve to the atmosphere (the default state of the ventilator at power-up or reset), and both remain open until ventilation begins. Minor faults are recorded in NOVRAM without interrupting POST.

Unless prevented by a POST, the transition to service mode can occur upon operator request. During service mode, the operator can select EST or system level tests. POST software can be updated without affecting the operational software (GUI and BDU).

Warning

Do not enter Service Mode with a patient attached to the ventilator. Serious injury could result.

16.6 POST user interface

POST includes these visual indicators:

- An indicator the ventilator is not delivering breaths.
- Discrete visual indicators on the BD CPU PCB that indicate the current test and step number.
- Illuminated VENT INOP indicator on the BDU to signal the user can press TEST to enter service mode.
- If possible, a display of fault information in case POST detects a failure.

If POST detects a major fault, qualified service personnel must run EST and correct the problem.

This page is intentionally blank.

Short self test (SST)

SST is a short (about 2 to 3 minutes) and simple sequence of tests that verifies proper operation of breath delivery hardware (including pressure and flow sensors), checks the patient circuit (including tubing, humidification device, and filters) for leaks, and measures the circuit compliance and resistance. SST also checks the resistance of the exhalation filter. Puritan Bennett recommends you run SST every 15 days, between patients, and when you change the patient circuit or its configuration (including changing the humidifier type, adding or removing an in-line water trap, or using a different type or style of patient circuit). Chapter 3 in the Operator's Manual part of this book tells you how to run SST. The Puritan Bennett™ 840 Ventilator System does not begin SST if it senses a patient is connected.

SST prompts you to verify no patient is attached and asks you to select the patient circuit and humidifier types. SST prompts you to block the wye, then verifies it is blocked. SST then tests the accuracy of the inspiratory and expiratory flow sensors, verifies proper function of pressure sensors, tests the patient circuit for leaks, calculates the compliance compensation for the patient circuit, measures the pressure drop across the expiratory filter, measures the resistance of the inspiratory and expiratory limbs of the patient circuit, then checks the pressure drop across the inspiratory limb.

Possible SST outcomes are:

- *Passed*: All tests passed (no faults detected).
- *ALERT*: A fault was detected. If it can be determined with certainty this cannot create a hazard for the patient, or add to the risk which may arise from other hazards, the user can choose to override the ALERT status and authorize ventilation.

- *OVERRIDDEN*: An ALERT status was overridden, and ventilation is authorized.
- *FAILURE*: One or more critical problems were detected. You cannot skip a test whose result is FAILURE. The ventilator does not allow ventilation until SST runs without failing any tests.

If SST is interrupted and ventilation was allowed before you started SST, normal ventilation is allowed if:

- SST did not detect any failures or alerts before the interruption, and
- no other errors that would prevent ventilation occurred, and
- you did not change the circuit type at the start of the interrupted SST. (If you *did* change the patient circuit type, you must successfully complete SST before normal ventilation can begin.)

During SST, the ventilator displays the current SST status, including the test currently in progress, results of completed tests, and measured data (where applicable). The ventilator logs SST results, and that information is available following a power failure. These keys are disabled during SST: ALARM SILENCE, ALARM RESET, MANUAL INSP, 100% O₂/CAL 2 min or INCREASE O₂ 2 min, and EXP PAUSE. The INFO key is functional during SST.

Refer to Chapter 3 How to run Short Self Test (SST) for instructions on running SST with appropriate patient circuits and accessories.

Extended self test (EST)

EST verifies the integrity of the Puritan Bennett™ 840 Ventilator System's subsystems using operator participation. EST requires a "gold standard" test circuit. All test resources, including the software code to run EST, are in the ventilator. EST testing, excluding tests of optional equipment (such as the compressor), takes about 15 minutes. A Single test feature allows individual EST tests to be run in any order, but the full suite of EST tests must have successfully passed before the ventilator can be used on a patient.

EST checks the pneumatics system (including the compressor), memory, safety system, front panel controls and indicators, digital and analog electronics, power supplies, analog out system, transducers, and options.

EST can run only when the ventilator is in service mode. Air and oxygen supplies are required (the compressor can supply the air source). EST is a comprehensive ventilator test designed to be run by qualified service personnel for periodic and corrective maintenance.

The main characteristics of EST include:

- EST fully tests the ventilator's electrical system, including non-major electronic functions (for example, battery power) and electronics subsystems that require operator intervention (for example, display/keyboard verification, and calibration).
- EST checks the pneumatics subsystem, including gas supplies, proportional solenoid (PSOL) valves, flow sensors, circuit pressure accuracy, safety valve, and exhalation valve.
- EST tests available options, including the compressor.
- Ventilator safe state tests (both GUI and BDU can force the ventilator into a ventilator inoperative state).

18.1 EST results

The ventilator displays the current test name, automatically runs tests that do not require operator action, prompts the operator to run tests that do require operator action, and displays test results. Once a test begins, it runs to completion. If an EST failure or alert occurs, the test name and results are displayed, and you can choose to rerun the test (for a FAILURE or an ALERT), skip to the next test (for an ALERT only), or quit EST.

At the end of EST, one of these overall results is displayed:

- *Passed*: All tests passed; normal ventilation can begin.
- *ALERT*: A fault was detected. If it can be determined with certainty this cannot create a hazard for the patient, or add to the risk which may arise from other hazards, the technician can choose to override the ALERT status and authorize ventilation.
- *OVERRIDDEN*: An ALERT status was overridden, and ventilation is authorized.
- *FAILURE*: One or more critical problems were detected. The ventilator does not allow normal ventilation until EST runs without failing any tests.
- *NEVER RUN*: After new ventilator software has been downloaded or a Single test EST was run, this message appears in the Ventilator Test Summary.
- *OUTCOME*: All EST tests required. After any Single test EST test is run, in order to ventilate a patient, service personnel must perform and successfully pass the full suite of EST tests. This message appears in the Diagnostic Code Log.

The technician must switch the ventilator to service mode, then choose to invoke EST. If the ventilator is powered down in EST after detecting one or more EST failures or alerts, the technician must run EST without a failure or non-overridden alert before the ventilator can begin normal ventilation.

If EST is interrupted and ventilation was allowed before you started EST, normal ventilation is allowed if EST did not detect any failures or alerts before the interruption, and no other errors occurred that would prevent ventilation.

EST is required if there is a major POST failure, a major system failure, or an EST failure or non-overridden alert. (Any minor or major POST fault that occurs outside of the kernel test is logged and time-stamped in nonvolatile memory.) When EST is required, including when a successful Single EST test is performed, normal ventilation is not allowed. EST is required until EST is completed without failures or non-overridden alerts.

18.2 EST failure handling

Ventilator response to EST failures or alerts depends on the type of test. If a failed test (failure or alert) is immediately repeated, the new results replace the previous results in memory. An EST failure or alert interrupts the regular sequence of EST tests.

18.3 EST safety considerations

To run EST, the technician must switch the ventilator to service mode, then request EST. (The technician can also use service mode to run field tests or upgrade software in the field.) The ventilator cannot provide ventilatory support during service mode, and is designed to prevent a software fault from causing an unrequested transition to service mode. You can enter service mode only upon power up, and a hardware interlock is required before the ventilator can switch to service mode.

Refer to the *Puritan Bennett 800 Series Ventilator System Service Manual* for instructions and equipment needed to run EST.

Caution

If you accidentally enter Service Mode, exit Service Mode by touching the EXIT button on the lower GUI screen and then pressing the ACCEPT key.

Do not attempt to run Extended Self Test (EST) with a patient circuit. Doing so will cause EST to fail. If EST fails, the ventilator will remain in a Vent Inop state until EST successfully passes.

This page is intentionally blank.

RS-232 commands

The Puritan Bennett™ 840 Ventilator System offers commands that allow communication to and from the ventilator using the RS-232 port:

- RSET
- SNDA
- SNDF

NOTE:

The ventilator responds only if it receives a carriage return <CR>.

19.1 RSET command

The RSET command clears data from the ventilator receive buffer. The ventilator does not send a response to the host system. Enter the RSET command exactly as shown:

```
RSET<CR>
```

19.2 SNDA command

The SNDA command instructs the ventilator to send information on ventilator settings and monitored data to the host system. Enter the SNDA command exactly as shown:

```
SNDA<CR>
```

When the ventilator receives the command SNDA<CR>, it responds with the code MISCA, followed by ventilator settings and monitored data information.

The MISCA response follows this format:

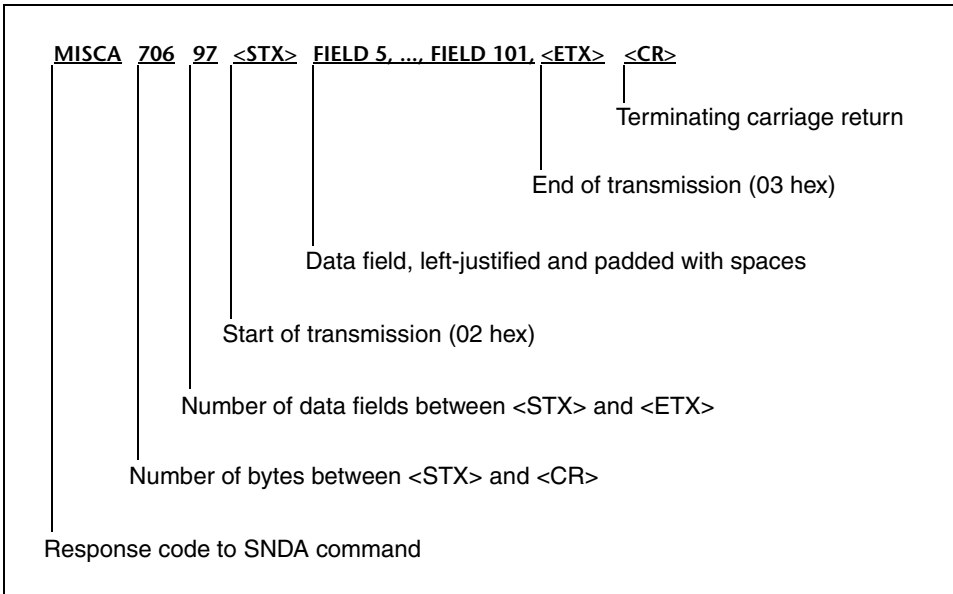

The MISCA response (including data fields) is as given in Table 19-1. The Puritan Bennett 840 Ventilator System follows the same format as the Puritan Bennett® 7200 Series Ventilator. Fields not available in the Puritan Bennett 840 Ventilator System are marked as “Not used.” Underscores represent one or more spaces that pad each character string.

Table 19-1: MISCA response

Component	Description
MISCA	Response to SNDA command (5 characters)
706	The number of bytes between <STX> and <CR> (3 characters)
97	The number of fields between <STX> and <ETX> (2 characters)
<STX>	Start of transmission character (02 hex)
Field 5	Ventilator time (HH:MM_) (6 characters)
Field 6	Ventilator ID to allow external hosts to uniquely identify each Puritan Bennett 840 Ventilator System (18 characters)
Field 7	Not used (6 characters)
Field 8	Date (MMM_DD_YYYY_) (12 characters)
Field 9	Mode (CMV__, SIMV__, CPAP__ or BILEVL) (CMV = A/C) setting (6 characters)
Field 10	Respiratory rate setting in breaths per minute (6 characters)
Field 11	Tidal volume setting in liters (6 characters)
Field 12	Peak flow setting in liters per minute (6 characters)
Field 13	O ₂ % setting (6 characters)
Field 14	Pressure sensitivity setting in cmH ₂ O (6 characters)
Field 15	PEEP or PEEP Low (in BILEVEL) setting in cmH ₂ O (6 characters)
Field 16	Plateau time in seconds (6 characters)
Field 17	Not used (6 characters)
Field 18	Not used (6 characters)

Table 19-1: MISCA response (cont)

Component	Description
Field 19	Not used (6 characters)
Field 20	Not used (6 characters)
Field 21	Apnea interval in seconds (6 characters)
Field 22	Apnea tidal volume setting in liters (6 characters)
Field 23	Apnea respiratory rate setting in breaths per minute (6 characters)
Field 24	Apnea peak flow setting in liters per minute (6 characters)
Field 25	Apnea O ₂ % setting (6 characters)
Field 26	Pressure support setting in cmH ₂ O (6 characters)
Field 27	Flow pattern setting (SQUARE or RAMP_) (6 characters)
Field 28	Not used (6 characters)
Field 29	Not used (6 characters)
Field 30	100% O ₂ state (ON____ or OFF____) (6 characters)
Field 31	Not used (6 characters)
Field 32	Not used (6 characters)
Field 33	Not used (6 characters)
Field 34	Total respiratory rate in breaths per minute (6 characters)
Field 35	Exhaled tidal volume in liters (6 characters)
Field 36	Exhaled minute volume in liters (6 characters)
Field 37	Spontaneous minute volume in liters (6 characters)
Field 38	Maximum circuit pressure in cmH ₂ O (6 characters)
Field 39	Mean airway pressure in cmH ₂ O (6 characters)
Field 40	End inspiratory pressure in cmH ₂ O (6 characters)
Field 41	Expiratory component of monitored value of I:E ratio, assuming inspiratory component of 1 (6 characters)

Table 19-1: MISCA response (cont)

Component	Description
Field 42	High circuit pressure limit in cmH ₂ O (6 characters)
Field 43	Not used (6 characters)
Field 44	Not used (6 characters)
Field 45	Low exhaled tidal volume limit in liters (6 characters)
Field 46	Low exhaled minute volume limit in liters (6 characters)
Field 47	High respiratory rate limit in breaths per minute (6 characters)
Field 48	High circuit pressure alarm status (NORMAL, ALARM_, or RESET_) (6 characters)
Field 49	Not used (6 characters)
Field 50	Not used (6 characters)
Field 51	Low exhaled tidal volume (mandatory or spontaneous) alarm status (NORMAL, ALARM_, or RESET_) (6 characters)
Field 52	Low exhaled minute volume alarm status (NORMAL, ALARM_, or RESET_) (6 characters)
Field 53	High respiratory rate alarm status (NORMAL, ALARM_, or RESET_) (6 characters)
Field 54	No O ₂ supply alarm status (NORMAL, ALARM_, or RESET_) (6 characters)
Field 55	No air supply alarm status (NORMAL, ALARM_, or RESET_) (6 characters)
Field 56	Not used (6 characters)
Field 57	Apnea alarm status (NORMAL, ALARM_, or RESET_) (6 characters)
Field 58	Not used (6 characters)
Field 59	Not used (6 characters)
Field 60	Ventilator time (HH:MM_) (6 characters)
Field 61	Not used (6 characters)

Table 19-1: MISCA response (cont)

Component	Description
Field 62	Date (MMM_DD_YYYY_) (12 characters)
Field 63	Static compliance (C_{STAT}) from inspiratory pause maneuver in mL/cmH ₂ O (6 characters)
Field 64	Static resistance (R_{STAT}) from inspiratory pause maneuver in cmH ₂ O/L/s (6 characters)
Field 65	Dynamic compliance (C_{DYN}) in mL/cmH ₂ O* (6 characters)
Field 66	Dynamic resistance (R_{DYN}) in cmH ₂ O/L/s* (6 characters)
Field 67	Negative inspiratory force (NIF) in cmH ₂ O* (6 characters)
Field 68	Vital capacity (VC) in L* (6 characters)
Field 69	Peak spontaneous flow (PSF) in L/min* (6 characters)
Field 70	Ventilator-set base flow in liters per minute (6 characters)
Field 71	Flow sensitivity setting in liters per minute (6 characters)
Field 72	Not used (6 characters)
Field 73	Not used (6 characters)
Field 74	Not used (6 characters)
Field 75	Not used (6 characters)
Field 76	Not used (6 characters)
Field 77	Not used (6 characters)
Field 78	Not used (6 characters)
Field 79	Not used (6 characters)
Field 80	Not used (6 characters)
Field 81	Not used (6 characters)
Field 82	Not used (6 characters)

* These fields will contain data only if the RM software option is installed.

Table 19-1: MISCA response (cont)

Component	Description
Field 83	Not used (6 characters)
Field 84	End inspiratory pressure in cmH ₂ O (6 characters)
Field 85	Inspiratory pressure or PEEP High setting in cmH ₂ O (6 characters)
Field 86	Inspiratory time or PEEP High time setting in seconds (6 characters)
Field 87	Apnea interval setting in seconds (6 characters)
Field 88	Apnea inspiratory pressure setting in cmH ₂ O (6 characters)
Field 89	Apnea respiratory rate setting in breaths per minute (6 characters)
Field 90	Apnea inspiratory time setting in seconds (6 characters)
Field 91	Apnea O ₂ % setting (6 characters)
Field 92	Apnea high circuit pressure limit in cmH ₂ O (6 characters)
Field 93	Alarm silence state (ON____ or OFF____) (6 characters)
Field 94	Apnea alarm status (NORMAL or ALARM_) (6 characters)
Field 95	Severe Occlusion/Disconnect alarm status (NORMAL or ALARM_) (6 characters)
Field 96	Inspiratory component of I:E ratio or High component of H:L (<i>Bi-Level</i>) setting (6 characters)
Field 97	Expiratory component of I:E ratio setting or Low component of H:L (<i>Bi-Level</i>) (6 characters)
Field 98	Inspiratory component of apnea I:E ratio setting (6 characters)
Field 99	Expiratory component of apnea I:E ratio setting (6 characters)
Field 100	Constant during rate setting change for pressure control mandatory breaths (I-TIME or I/E____ or_____) (6 characters) (where _____ represents E-TIME or PCV not active)
Field 101	Monitored value of I:E ratio (6 characters)
<ETX>	End of transmission character (03 hex)
<CR>	Terminating carriage return

19.3 SNDF command

SNDF is a command sent from an external host device to the Puritan Bennett 840 Ventilator System instructing it to transmit all ventilator settings data, monitored patient data, and alarm settings and occurrences. Enter the SNDF command exactly as shown:

SNDF<CR>

When the ventilator receives the command SNDF<CR>, it responds with the code MISCF, followed by ventilator settings, monitored data, and alarm information.

The MISCF response follows this format:

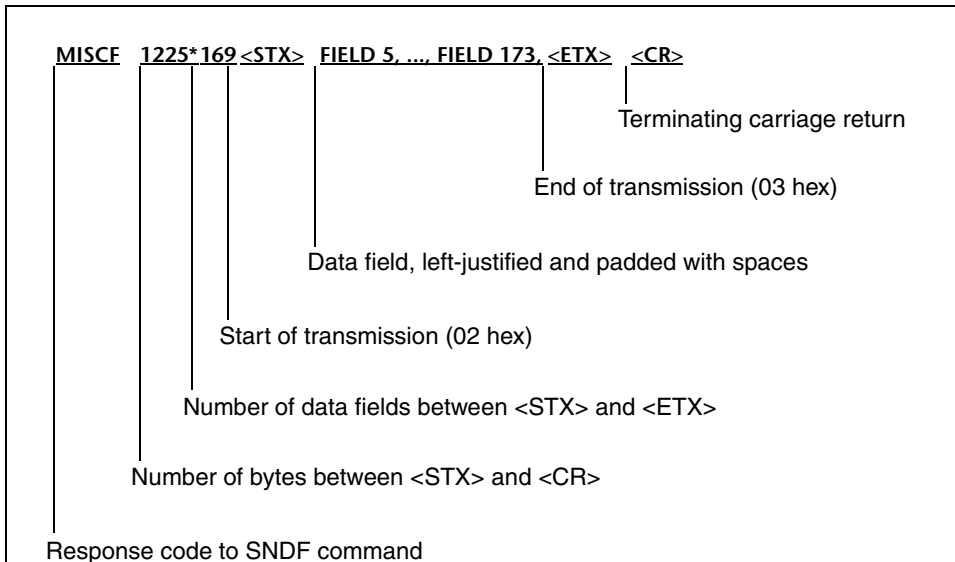

*1229 if "Phillips" is selected for serial port in Communication Setup

Table 19-2 lists the MISCF message components and their descriptions.

NOTE:

Non-applicable fields will either contain zero or be blank.

Table 19-2: MISCF response

Component	Description
MISCF	Response to SNDF command (5 characters)
1225*	Number of bytes between <STX> and <CR> (4 characters) *1229 if "Phillips is selected for serial port in Communication Setup
169	Number of fields between <STX> and <ETX> (3 characters)
<STX>	Start of transmission character (02 hex)
Field 5	Ventilator time (HH:MM_) (6 characters)
Field 6	Ventilator ID to allow external hosts to uniquely identify each Puritan Bennett 840 Ventilator System (18 characters)
Field 7	Date (MMM_DD_YYYY_) (12 characters)
Field 8	Vent Type (NIV_____ or INVASIVE_) (9 characters)
Field 9	Mode (A/C___, SIMV___, SPONT_ or BILEVL) (6 characters)
Field 10	Mandatory Type (PC___, VC___, VC+___) (6 characters)
Field 11	Spontaneous Type (NONE___, PS___, TC___, VS___, PA___) (6 characters)
Field 12	Trigger Type setting (V-Trig or P-Trig) (6 characters)
Field 13	Respiratory rate setting in bpm (6 characters)
Field 14	Tidal volume setting in L (6 characters)
Field 15	Peak flow setting in L/min (6 characters)
Field 16	O ₂ % setting (6 characters)
Field 17	Pressure sensitivity setting in cmH ₂ O (6 characters)
Field 18	PEEP/CPAP in cmH ₂ O (6 characters)

Table 19-2: MISCF response (cont)

Component	Description
Field 19	Plateau setting in seconds (6 characters)
Field 20	Apnea interval setting in seconds (6 characters)
Field 21	Apnea tidal volume setting in L (6 characters)
Field 22	Apnea respiratory rate setting in bpm (6 characters)
Field 23	Apnea peak flow setting in L/min (6 characters)
Field 24	Apnea O ₂ % setting (6 characters)
Field 25	PCV apnea inspiratory pressure setting in cmH ₂ O (6 characters)
Field 26	PCV Apnea Inspiratory Time setting in seconds (6 characters)
Field 27	Apnea flow pattern setting (SQUARE or RAMP) (6 characters)
Field 28	Apnea mandatory type setting (PC or VC) (6 characters)
Field 29	Inspiratory component of Apnea I:E ratio (if apnea mandatory type is PC) (6 characters)
Field 30	Expiratory component of Apnea I:E ratio (if apnea mandatory type is PC) (6 characters)
Field 31	Support pressure setting (cmH ₂ O)
Field 32	Flow pattern setting (SQUARE or RAMP) (6 characters)
Field 33	100% O ₂ Suction (ON or OFF) (6 characters)
Field 34	High inspiratory pressure alarm setting ($\bar{\uparrow}P_{PEAK}$) in cmH ₂ O (6 characters)
Field 35	Low inspiratory pressure alarm setting ($\downarrow P_{PEAK}$) in cmH ₂ O or OFF (6 characters)
Field 36	High exhaled minute volume ($\bar{\uparrow}V_{E\ TOT}$) alarm setting in L/min or OFF (6 characters)

Table 19-2: MISCF response (cont)

Component	Description
Field 37	Low exhaled minute volume ($\downarrow\dot{V}_{E\text{ TOT}}$) alarm setting in L/min or OFF (6 characters)
Field 38	High exhaled mandatory tidal volume ($\uparrow V_{TE\text{ MAND}}$) alarm setting in mL or OFF (6 characters)
Field 39	Low exhaled mandatory tidal volume ($\downarrow V_{TE\text{ MAND}}$) alarm setting in mL or OFF (6 characters)
Field 40	High exhaled spontaneous tidal volume ($\uparrow V_{TE\text{ SPONT}}$) alarm setting in mL or OFF (6 characters)
Field 41	Low exhaled spontaneous tidal volume ($\downarrow V_{TE\text{ SPONT}}$) alarm setting in mL or OFF (6 characters)
Field 42	High respiratory rate ($\uparrow f_{\text{TOT}}$) alarm setting in bpm or OFF (6 characters)
Field 43	High inspired tidal volume ($\uparrow V_{TI}$) alarm setting in mL (6 characters)
Field 44	Base flow setting in L/min (6 characters)
Field 45	Flow sensitivity setting in L/min (6 characters)
Field 46	PCV inspiratory pressure (P_I) setting in cmH ₂ O (6 characters)
Field 47	PCV inspiratory time (T_I) setting in seconds (6 characters)
Field 48	Inspiratory component of I:E ratio setting or High component of H:L ratio setting (6 characters)
Field 49	Expiratory component of I:E ratio setting or Low component of H:L ratio setting (6 characters)
Field 50	Constant during rate change setting (I-time, I/E, or E-time) (6 characters)
Field 51	Tube I.D. setting in mm (6 characters)
Field 52	Tube type setting (ET or TRACH) (6 characters)
Field 53	Humidification type setting (Non-Heated Exp, Heated Exp, or HME) (18 characters)

Table 19-2: MISCF response (cont)

Component	Description
Field 54	Humidifier volume setting in L (6 characters)
Field 55	O ₂ sensor setting (Enabled or Disabled) (9 characters)
Field 56	Disconnect sensitivity setting in % or OFF (6 characters)
Field 57	Rise time % setting (6 characters)
Field 58	PAV+ percent support setting (6 characters)
Field 59	Expiratory sensitivity (E _{SENS}) setting in % or L/min for PA breath type (6 characters)
Field 60	IBW setting in kg (6 characters)
Field 61	Target support volume (V _{T SUPP}) setting in L (6 characters)
Field 62	High PEEP (PEEP _H) setting in cmH ₂ O (6 characters)
Field 63	Low PEEP (PEEP _L) setting in cmH ₂ O (6 characters)
Field 64	High PEEP time (T _H) setting in seconds (6 characters)
Field 65	High spontaneous inspiratory time limit (τ _{I SPONT}) setting in seconds (6 characters)
Field 66	Circuit type setting (ADULT, PEDIATRIC, or NEONATAL) (9 characters)
Field 67	Low PEEP time (T _L) setting in seconds (6 characters)
Field 68	Expiratory time (T _E) setting in seconds (6 characters)
Field 69	End inspiratory pressure (P _{I END}) in cmH ₂ O (6 characters)
Field 70	Respiratory rate (f _{TOT}) in bpm (6 characters)
Field 71	Exhaled tidal volume (V _{TE}) in L (6 characters)
Field 72	Patient exhaled minute volume (V̇ _{E TOT}) in L/min (6 characters)
Field 73	Peak airway pressure (P _{PEAK}) in cmH ₂ O (6 characters)

Table 19-2: MISCF response (cont)

Component	Description
Field 74	Mean airway pressure (P_{MEAN}) in cmH_2O (6 characters)
Field 75	Expiratory component of monitored value of I:E ratio, assuming inspiratory component of 1 (6 characters)
Field 76	I:E ratio (6 characters)
Field 77	Delivered $\text{O}_2\%$ (6 characters)
Field 78	Inspired tidal volume (V_{T_I}) in L (6 characters)
Field 79	Intrinsic PEEP ($PEEP_I$) in cmH_2O (6 characters)
Field 80	Estimated total resistance (R_{TOT}) in $\text{cmH}_2\text{O}/\text{L}/\text{s}$ (6 characters)
Field 81	Estimated patient resistance (R_{PAV}) in $\text{cmH}_2\text{O}/\text{L}/\text{s}$ (6 characters)
Field 82	Estimated patient elastance (E_{PAV}) in $\text{cmH}_2\text{O}/\text{L}$ (6 characters)
Field 83	Estimated patient compliance (C_{PAV}) in $\text{mL}/\text{cmH}_2\text{O}$ (6 characters)
Field 84	Normalized rapid shallow breathing index ($f/V_{T_I}/\text{kg}$) (6 characters)
Field 85	Rapid shallow breathing index (f/V_{T_I}) (6 characters)
Field 86	Spontaneous percent inspiratory time (T_I/T_{TOT}) (6 characters)
Field 87	Monitored PEEP in cmH_2O (6 characters)
Field 88	Spontaneous inspiratory time ($T_I\text{ SPONT}$) in seconds (6 characters)
Field 89	Exhaled spontaneous minute volume ($\dot{V}_{E\text{ SPONT}}$) in L/min (6 characters)
Field 90	Intrinsic PEEP ($PEEP_I$) from expiratory pause maneuver in cmH_2O (6 characters)

Table 19-2: MISCF response (cont)

Component	Description
Field 91	Total PEEP ($PEEP_{TOT}$) from expiratory pause maneuver in cmH_2O (6 characters)
Field 92	Static compliance (C_{STAT}) from inspiratory pause maneuver in mL/cmH_2O (6 characters)
Field 93	Static resistance (R_{STAT}) from inspiratory pause maneuver in $cmH_2O/L/s$ (6 characters)
Field 94	Plateau pressure (P_{PL}) from inspiratory pause maneuver in cmH_2O (6 characters)
Field 95	High spontaneous inspiratory time (ALERT_ or blank) (6 characters)
Field 96	Dynamic compliance (C_{DYN}) in mL/cmH_2O (6 characters)
Field 97	Dynamic resistance (R_{DYN}) in $cmH_2O/L/s$ (6 characters)
Field 98	Peak spontaneous flow (PSF) in L/min (6 characters)
Field 99	Peak expiratory flow (PEF) in L/min (6 characters)
Field 100	End expiratory flow (EEF) in L/min (6 characters)
Field 101	Reserved
Field 102	Negative inspiratory force (NIF) in cmH_2O (6 characters)
Field 103	$P_{0.1}$ pressure change in cmH_2O (6 characters)
Field 104	Vital capacity (VC) in L (6 characters)
Field 105	Alarm Silence (ON or OFF) (6 characters)
Field 106	Apnea ventilation alarm* (6 characters)
Field 107	High exhaled minute volume alarm* ($\uparrow\dot{V}_{E\ TOT}$) (6 characters)
Field 108	High exhaled tidal volume alarm* ($\uparrow V_{TE}$) (6 characters)

* Possible responses are: NORMAL, LOW, MEDIUM, HIGH, or RESET.

Table 19-2: MISCF response (cont)

Component	Description
Field 109	High O ₂ % alarm* (6 characters)
Field 110	High inspiratory pressure alarm* ($\uparrow P_{PEAK}$) (6 characters)
Field 111	High ventilator pressure alarm* ($\uparrow P_{VENT}$) (6 characters)
Field 112	High respiratory rate alarm* ($\uparrow f_{TOT}$) (6 characters)
Field 113	AC power loss alarm* (6 characters)
Field 114	Inoperative battery alarm* (6 characters)
Field 115	Low battery alarm* (6 characters)
Field 116	Loss of power alarm* (6 characters)
Field 117	Low exhaled mandatory tidal volume alarm* ($\downarrow V_{TE MAND}$) (6 characters)
Field 118	Low exhaled minute volume alarm* ($\downarrow \dot{V}_{E TOT}$) (6 characters)
Field 119	Low exhaled spontaneous tidal volume ($\downarrow V_{TE SPONT}$) alarm* (6 characters)
Field 120	Low O ₂ % alarm* (6 characters)
Field 121	Low air supply pressure alarm* (6 characters)
Field 122	Low O ₂ supply pressure alarm* (6 characters)
Field 123	Compressor inoperative alarm* (6 characters)
Field 124	Disconnect alarm* (6 characters)
Field 125	Severe occlusion alarm* (6 characters)
Field 126	Inspiration too long alarm* (6 characters)
Field 127	Procedure error* (6 characters)
Field 128	Compliance limited tidal volume (V_T) alarm* (6 characters)

* Possible responses are: NORMAL, LOW, MEDIUM, HIGH, or RESET.

Table 19-2: MISCF response (cont)

Component	Description
Field 129	High inspired spontaneous tidal volume* ($\uparrow V_{TI\ SPONT}$) alarm(6 characters)
Field 130	High inspired mandatory tidal volume ($\uparrow V_{TI\ MAND}$) alarm* (6 characters)
Field 131	High compensation limit ($\uparrow P_{COMP}$) alarm* (6 characters)
Field 132	PAV startup too long alarm* (6 characters)
Field 133	PAV R and C not assessed alarm* (6 characters)
Field 134	Volume not delivered (VC+) alarm* (6 characters)
Field 135	Volume not delivered (VS) alarm* (6 characters)
Field 136	Low inspiratory pressure ($\downarrow P_{PEAK}$) alarm* (6 characters)
Field 137	Technical malfunction A5* (6 characters)
Field 138	Technical malfunction A10* (6 characters)
Field 139	Technical malfunction A15* (6 characters)
Field 140	Technical malfunction A20* (6 characters)
Field 141	Technical malfunction A25* (6 characters)
Field 142	Technical malfunction A30* (6 characters)
Field 143	Technical malfunction A35* (6 characters)
Field 144	Technical malfunction A40* (6 characters)
Field 145	Technical malfunction A45* (6 characters)
Field 146	Technical malfunction A50* (6 characters)
Field 147	Technical malfunction A55* (6 characters)
Field 148	Technical malfunction A60* (6 characters)

* Possible responses are: NORMAL, LOW, MEDIUM, HIGH, or RESET.

Table 19-2: MISCF response (cont)

Component	Description
Field 149	Technical malfunction A65* (6 characters)
Field 150	Technical malfunction A70* (6 characters)
Field 151	Technical malfunction A75* (6 characters)
Field 152	Technical malfunction A80* (6 characters)
Field 153	Technical malfunction A85* (6 characters)
Field 154	Spontaneous tidal volume ($V_{TE\ SPONT}$) in liters (6 characters)
Field 155	Total work of breathing (WOB_{TOT}) in Joules/L (6 characters)
Field 156	Leak compensation state (9 characters) (enable, disable, or blank)
Field 157	%LEAK (6 characters)
Field 158	LEAK @ PEEP (6 characters)
Field 159	V_{LEAK} (6 characters)
Field 160	Reserved
Field 161	Reserved
Field 162	Reserved
Field 163	Reserved
Field 164	Reserved
Field 165	Reserved

* Possible responses are: NORMAL, LOW, MEDIUM, HIGH, or RESET.

Field 166	Reserved
Field 167	Reserved
Field 168	Reserved
Field 169	Reserved

Table 19-2: MISC response (cont)

Component	Description
Field 170	Reserved
Field 171	Reserved
<ETX>	End of transmission character (03 hex)
<CR>	Terminating carriage return

NOTE:

See Chapter 1 of the Operator's Manual portion of this book for definitions of onscreen abbreviations.

A	Amperes (unit of electric current)
A/C	Assist/control mode. A ventilatory mode in which the ventilator delivers only mandatory breaths (patient-, ventilator-, or operator-initiated) according to the current settings.
AC	Alternating current.
alarm log	A record of alarm events (including time-stamped alarms, silences, and resets) in order of occurrence, with the most recent event at the top of the list.
alarm message	A message that accompanies alarm annunciation that consists of a <i>base message</i> (which identifies the alarm), an <i>analysis message</i> (which lists the root cause and any associated alarms that may have arisen due to the initial alarm), and a <i>remedy message</i> (which suggests corrective actions).
alarm reset key	Key that clears all alarm indicators and cancels the alarm silence period.
alarm silence key	Key that silences alarm sound for two minutes from the most recent key press, but does not change visual indicators.
ALERT	A category of condition detected during SST or EST. An ALERT may be overridden provided that it can be determined with certainty that the defect in the ventilator or associated component cannot create a hazard for the patient, or add to the risks that may arise from other hazards.
apnea	Cessation of breathing. The Puritan Bennett™ 840 Ventilator System declares apnea and begins apnea ventilation when the breath-to-breath interval exceeds the set apnea interval (T_A).
autoreset	When an alarm becomes inactive (that is, alarm conditions no longer exist) without pressing the alarm reset key.

Glossary

autotriggering	The ventilator delivers repeated, unintended breaths triggered by fluctuating flows or pressures as opposed to patient demand. Patient circuit leaks and low flow or pressure sensitivity settings are common causes of autotriggering.
background checks	Continuously running tests during ventilation that assess the ventilator's electronics and pneumatics hardware.
base flow	A constant flow of gas through the patient circuit during the latter part of exhalation during flow triggering (V_{TRIG}). The value of this base flow is 1.5 L/min greater than the operator-selected value for flow sensitivity.
batch changes	Changes to multiple settings that go into effect at the same time. On the Puritan Bennett 840 Ventilator System, no setting changes go into effect until you press the ACCEPT key.
battery back-up system	The system in the Puritan Bennett 800 Series Ventilator Compressor Mount Cart or Puritan Bennett 800 Series Ventilator Pole Cart that supplies battery back-up power to the ventilator. The Puritan Bennett 800 Series Ventilator Compressor Mount Cart has a BPS with a one-hour battery or an optional four-hour battery. The one-hour BPS behaves identically to the 802 BPS. The four-hour BPS behaves identically to the 803 BPS. The Puritan Bennett 800 Series Ventilator Pole Cart can be used with a one-hour or four-hour battery which is installed in the cart base assembly. Similarly, the one-hour and four-hour batteries behave identically to the 802 and 803 BPS, respectively.
BD, BDU	Breath delivery or breath delivery unit. The ventilator component that includes inspiratory and expiratory pneumatics and electronics. The Puritan Bennett 840 Ventilator System BDU includes its own independent CPU that controls ventilation.
BOC	British Oxygen Company, a standard for high pressure gas inlet fittings.

BPS	Backup Power Source. The 802 BPS provides DC power to the BDU power supply (which, in turn, supplies power to the GUI) in the event AC power is lost. Depending on ventilator settings, the BPS can supply backup power for at least 60 minutes (30 minutes on ventilators built prior to July 2007) under nominal conditions. The 803 BPS provides DC power to the BDU and GUI for at least four hours (depending on ventilator settings) in the event of AC power loss.
breath stacking	The delivery of a second inspiration before the first exhalation is complete.
breaths per minute	Unit of respiratory rate (1/min).
BTPS	Body temperature and pressure, saturated, 37 °C, at ambient barometric pressure, at 100% relative humidity.
CE	A certification mark issued under the authority of the European Common Market that indicates compliance with the Medical Device Directive, 93/42/EEC.
clinical alarm	An alarm that can indicate an abnormal physiologic condition.
cm	Centimeter (unit of length).
cmH ₂ O	Centimeters of water (unit of pressure approximately equal to 1 hPa).
compliance volume	The volume of gas that remains in the patient circuit and does not enter the patient's respiratory system.
compressor	On the Puritan Bennett 840 Ventilator System, the optional 806 Compressor, which provides compressed air to the BDU, and can be used in place of wall or bottled air. The 806 Compressor is powered through and communicates with the BDU.
constant during rate change	One of three breath timing variables (inspiratory time, I:E ratio, or expiratory time) that the operator can set to be held constant when the respiratory rate setting changes. Applies only to the pressure control (PC) mandatory breath type (including VC+ and BILEVEL). You can change the value of the constant parameter at any time, but the value does not change as a result of changing the respiratory rate setting.
CPU	Central processing unit.
CSA	Canadian Standards Association.

Glossary

D_{SENS}	Disconnect sensitivity, a setting that specifies the allowable loss (percentage) of delivered tidal volume, which if equaled or exceeded, causes the ventilator to declare a DISCONNECT alarm. The greater the setting, the more returned volume must be lost before DISCONNECT is detected.
DC	Direct current.
dependent alarm	An alarm that arises as a result of another <i>primary</i> alarm.
DISS	Diameter index safety standard, a standard for high pressure gas inlet fittings.
<i>DualView</i>	The Puritan Bennett 840 Ventilator System's two touch screens, which display monitored data separately from ventilator settings.
E_{SENS}	Expiratory sensitivity, the percent of peak inspiratory flow (or flow rate expressed in L/min in a PA breath) at which the ventilator cycles from inspiration to exhalation for spontaneous breaths. Low E_{SENS} settings will result in longer spontaneous inspirations.
EMC	Electromagnetic compatibility.
EN	European norm (referring to the European Common Market).
EST	Extended self test, a comprehensive test of ventilator function, intended to be run by qualified service personnel.
ETO	Ethylene oxide.
EXP PAUSE	Expiratory pause, an operator-initiated maneuver that closes the inspiration (proportional solenoid) and exhalation valves during the exhalation phase of a mandatory breath. The maneuver can be used to determine intrinsic (auto) PEEP ($PEEP_I$).
f, f_{TOT}	Respiratory rate, as a setting (f) in A/C, SIMV, and BILEVEL the minimum number of mandatory breaths the patient receives per minute. As a monitored value (f_{TOT}), the average total number of breaths delivered to the patient.
FAILURE	A category of condition detected during SST or EST that causes the ventilator to enter the safety valve open state. A ventilator that has experienced a FAILURE requires removal from clinical use and immediate service.

flow pattern	The gas flow pattern of mandatory volume-controlled breaths (the Puritan Bennett 840 Ventilator System offers the choice of square or descending ramp flow patterns).
<i>Flow-by</i> flow triggering	The patented flow-triggering strategy used on 800 Series Ventilators.
ft	Feet (unit of length).
gold standard test circuit	Test circuit designed for use with EST.
Graphics	A standard function on the Puritan Bennett 840 Ventilator System that displays real-time patient data, including: pressure-time curve, flow-time curve, volume-time curve, pressure-volume loop.
GUI	Graphic user interface, the ventilator component that includes the touch screens, keys, and knob. The GUI includes its own independent CPU that monitors ventilator and patient data. The upper screen displays monitored information, including alarms, monitored data, and graphics. The lower screen shows ventilator settings, symbol definitions, and prompts.
high-urgency alarm	As defined by international standards organizations, an alarm that requires immediate attention to ensure patient safety. When a high-urgency alarm is active, the red high-urgency indicator (!!!) flashes and the high-urgency audible alarm sounds (a repeating sequence of five tones that repeats twice, pauses, then repeats again), and the top of the upper screen shows an alarm message.
HME	Heat-moisture exchanger, a humidification device, also called an artificial nose.
hPa	Hectopascal (unit of pressure, approximately equal to 1 cmH ₂ O).
humidification type	A setting for the type of humidification system (HME, non-heated expiratory tube, or heated expiratory tubing) in use on the ventilator.
Hz	Hertz (unit of frequency, indicating cycles per second).
I:E ratio	The ratio of inspiratory time to expiratory time. Also, the operator-set timing variable that applies to PC and VC+ mandatory breaths.

Glossary

IBW	Ideal body weight, a ventilator setting that specifies the patient's body weight assuming normal fat and fluid levels. Determines absolute limits on tidal volume and peak flow, and allows appropriate matching of ventilator settings to patient.
idle mode	A ventilation mode in effect during a patient circuit disconnect. When the ventilator is in this mode, the exhalation valve opens, <i>idle flow</i> (10 L/min flow at 100% O ₂ or at 40% O ₂ in <i>NeoMode</i> , if available) begins, and breath triggering is disabled.
IEC	International Electrotechnical Commission, a standards organization.
INSP PAUSE	Inspiratory pause, an operator-initiated maneuver that closes the inspiration (proportional solenoid) and exhalation valves at the end of the inspiratory phase of a mandatory breath. The maneuver can be used to determine static compliance (C _{STAT}) and resistance (R _{STAT}).
ISO	International Standards Organization, a standards organization.
kg	Kilogram (unit of weight).
L	Liter (unit of volume).
L/min	Liters per minute (unit of flow).
lb	Pound (unit of weight).
low-urgency alarms	As defined by international standards organizations, an alarm that indicates a change in the patient-ventilator system. During a low-urgency alarm, the yellow low-urgency indicator (!) lights, the low-urgency audible alarm (one tone) sounds, and the upper screen shows an alarm message.
m	Meter (unit of length).
maintenance	All actions necessary to keep equipment in, or restore it to, serviceable condition. Includes cleaning, servicing, repair, modification, overhaul, inspection, and performance verification.
mandatory	A breath whose settings and timing are preset; can be triggered by the ventilator, patient, or operator. The Puritan Bennett 840 Ventilator System allows you to select volume-controlled (VC), VC+, or pressure-controlled (PC) mandatory breaths.

mandatory type	The type of mandatory breath: volume control (VC) , VC+, or pressure control (PC).
manual inspiration	An OIM breath. Pressing the MANUAL INSP key on the Puritan Bennett 840 Ventilator System delivers one mandatory breath to the patient.
medium-urgency alarm	As defined by international standards organizations, an abnormal condition that requires prompt attention to ensure the safety of the patient. When a medium-urgency alarm is active, the yellow medium-urgency indicator (!!) flashes, the medium-urgency audible alarm (a repeating sequence of three tones) sounds, and the upper screen shows an alarm message.
min	Minute (unit of time).
mL	Milliliter (unit of volume).
mode	Ventilatory mode, the algorithm that determines type and sequence of breath delivery. The Puritan Bennett 840 Ventilator System offers a choice of assist/control (A/C), spontaneous (SPONT), or synchronous intermittent mandatory ventilation (SIMV), or BILEVEL.
MRI	Magnetic resonance imaging.
ms	Millisecond (unit of time).
NIST	Non-interchangeable screw thread, a standard for high pressure gas inlet fittings.
normal ventilation	The state of the ventilator when breathing is in progress and no alarms are active.
NOVRAM	Nonvolatile random access memory. Memory that is preserved even when power to the ventilator is not available.
O ₂ %	Both an operator-set and monitored variable. The O ₂ % setting determines the percentage of oxygen in the delivered gas. The O ₂ % monitored data is the percentage of oxygen in the gas delivered to the patient, measured at the ventilator outlet upstream of the inspiratory filter.
OIM	Operator-initiated mandatory breath, a breath that is delivered when the operator presses MANUAL INSP.

Glossary

ongoing background checks	Continuously running tests during ventilation that assess the ventilator's electronics and pneumatics hardware.
OSC	Occlusion status cycling. A ventilation mode in effect during a severe occlusion. In this mode, the ventilator periodically attempts to deliver a pressure-based breath while monitoring the inspiration and expiration phases for the continuing existence of the occlusion.
OVERRIDDEN	The final status of an SST or EST run in which the operator used the override feature. (The ventilator must have ended the test with an ALERT condition.)
P_{MEAN}	Mean circuit pressure, a calculation of the measured average patient circuit pressure over an entire respiratory cycle.
PEEP	End expiratory pressure, the measured circuit pressure (referenced to the patient wye) at the end of the expiratory phase of a breath. If expiratory pause is active, the displayed value reflects the level of any active lung PEEP.
P_{I}	Inspiratory pressure, the operator-set inspiratory pressure at the patient wye (above PEEP) during a pressure control (PC) mandatory breath.
$P_{\text{I END}}$	End inspiratory pressure, the pressure at the end of the inspiration phase of the current breath. If plateau is active, the displayed value reflects the level of end-plateau pressure.
P_{PEAK}	Maximum circuit pressure, the maximum pressure during the inspiratory phase of a breath.
P_{SENS}	Pressure sensitivity, the operator-set pressure drop below PEEP (derived from the patient's inspiratory flow) required to begin a patient-initiated breath when pressure triggering is selected. Not available with <i>NeoMode</i> or when Vent Type is NIV.
P_{SUPP}	Pressure support, a setting of the level of inspiratory assist pressure (above PEEP) at the patient wye during a spontaneous breath (when spontaneous breath type is PS).
$P_{\text{-TRIG}}$	Pressure triggering, a method of recognizing patient inspiratory effort in which the ventilator monitors pressure in the patient circuit. The ventilator triggers a breath when the airway pressure drops by at least the value selected for pressure sensitivity (P_{SENS}).

patient circuit	The entire inspiratory-expiratory conduit, including tubing, humidifier, and water traps.
patient data alarm	An alarm condition associated with an abnormal condition of the patient's respiratory status.
patient problems	A definition used by the ventilator's safety net. Patient problems are declared when patient data is measured equal to or outside of alarm thresholds and are usually self-correcting or can be corrected by a practitioner. The alarm monitoring system detects and announces patient problems. Patient problems do not compromise the ventilator's performance.
PC	Pressure control; A mandatory breath type in which the ventilator delivers an operator-set inspiratory pressure for an operator-set inspiratory time. Available in A/C and SIMV modes, and for operator-initiated mandatory (OIM) breaths in SPONT mode.
PEEP	Positive end-expiratory pressure, the minimum level of pressure maintained in the patient circuit throughout ventilation. Both an operator-set and monitored variable. The level of PEEP is also called <i>baseline</i> pressure.
PIM	Patient-initiated mandatory breath. A mandatory breath that is triggered by patient inspiratory effort.
POST	Power on self test, a self test that the ventilator runs to verify the integrity of ventilator electronics. The ventilator runs POST when it is powered on, following a power loss, or if the ventilator detects internal timing errors.
preventive maintenance	Procedures that keep the ventilator and its subassemblies in satisfactory operational condition by providing system inspection, detection, and prevention of failures. Procedures include fan and filter replacement, lubrication, calibration, etc.
PS	Pressure support, a spontaneous breath type in which the ventilator delivers an operator-set pressure (in addition to PEEP) during the inspiratory phase. Available in SPONT, SIMV, and BILEVEL modes.
PSOL	Proportional solenoid valve.
RAM	Random access memory.

Glossary

resistance	The flow-dependent pressure drop across a conduit. Measured in cmH ₂ O/L/s or hPa/L/s.
restricted phase of exhalation	The specific time period during the exhalation phase where an inspiration trigger is not allowed. The conditions associated with the restricted phase of exhalation are as follows: Net flow \geq 50% of peak net flow (peak net flow is measured after 100 ms of exhalation time have elapsed) OR Expiratory flow is greater than 0.5 L/min and exhalation elapsed time is less than 200 ms OR Less than 5 seconds of exhalation have elapsed
rise time %	A setting that determines the rise time to achieve the set inspiratory pressure in pressure-controlled (PC) , VC+, BILEVEL, or pressure-supported (PS) breaths. The larger the value, the more aggressive the rise of pressure.
s	Second (unit of time).
safety net	The ventilator's strategy for responding to patient problems and system faults.
safety ventilation	A mode of ventilation that becomes active if the patient circuit is connected before ventilator startup is complete, or when power is restored after a loss of 5 minutes or more.
<i>SandBox</i>	Capability that allows you to preview settings before applying them to your patient.
service mode	A ventilator mode that provides a set of services tailored to the needs of testing and maintenance personnel. No ventilation is delivered while the ventilator is in the service mode.
SIMV	Synchronous intermittent mandatory ventilation, a ventilatory mode in which the ventilator delivers one mandatory breath per breath cycle and as many spontaneous breaths as the patient can trigger during the remainder of the breath cycle.
SIS	Sleeved index system, a standard for high pressure gas inlet fittings.
<i>SmartAlert</i>	Alarm annunciation system which helps you to quickly determine the urgency and root cause of alarm conditions.

SL/min	Standard liters per minute (unit of flow measured at 0° C (32° F) and 1 atm (14.7 psia) pressure).
soft bound	A ventilator setting that has reached its recommended high or low limit. Setting the ventilator beyond this limit requires the operator to acknowledge the prompt to continue.
SPONT	Spontaneous, a ventilatory mode in which the ventilator delivers only spontaneous breaths. In SPONT mode, the patient triggers all breaths delivered by the ventilator with no set mandatory respiratory rate. The patient controls the breath variables, and the breath can be augmented by support pressure.
spontaneous type	A setting that determines whether spontaneous breaths are pressure-supported (PS), volume-supported (VS), tube-compensated (TC), proportionally assisted (PA), or not (NONE).
SST	Short self test, a test that checks circuit integrity, calculates circuit compliance and filter resistance, and checks ventilator function. SST is intended to be run by the operator at specified intervals and whenever a patient circuit is changed. Refer to Section 3.2 on page OP 3-2 for information on when to run SST.
STPD	Standard temperature and pressure, dry. Defined as dry gas at a standard atmosphere (760 mmHg, 101.333 kPa, approximately 1.0 bar) and 0 °C.
SVO	Safety valve open, an emergency state in which the ventilator opens the safety valve so that the patient can breathe room air unassisted by the ventilator. An SVO state does not necessarily indicate a ventilator inoperative condition. The ventilator enters an SVO state if a hardware or software failure occurs that could compromise safe ventilation, both air and oxygen supplies are lost, or an occlusion is detected.
system fault	A definition used by the ventilator's safety net. System faults include hardware faults (those that originate inside the ventilator and affect its performance), soft faults (faults momentarily introduced into the ventilator that interfere with normal operation), inadequate supply (AC power or external gas pressure), and patient circuit integrity (blocked or disconnected circuit). System faults are not usually self-correcting and are handled under the assumption that they can affect the ventilator's performance.

Glossary

T_A	Apnea interval, the operator-set variable that defines the breath-to-breath interval which, if exceeded, causes the ventilator to declare apnea and enter apnea ventilation.
T_b	Breath cycle.
T_E	Expiratory time, the expiratory interval of a breath. Also the operator-set timing variable that determines the expiratory period for pressure-controlled (PC) or VC+ mandatory breaths.
T_I	Inspiratory time, the inspiratory interval of a breath. Also, the operator-set timing variable that determines the inspiratory interval for pressure-controlled (PC) or VC+ mandatory breaths.
T_m	Mandatory interval portion of SIMV breath cycle; it is reserved for a PIM.
T_{PL}	Plateau time, the amount of time the inspiration phase of a mandatory breath is extended after inspiratory flow has ceased and exhalation is blocked. Increases the residence time of gas in the patient's lungs.
T_s	Spontaneous interval portion of SIMV breath cycle; it is reserved for spontaneous breathing throughout the remainder of the breath cycle.
V	Volts (unit of voltage).
\dot{V}_{-TRIG}	Flow triggering, a method of recognizing patient inspiratory effort in which the ventilator monitors the difference between inspiratory and expiratory flow measurements. The ventilator triggers a breath when the difference between inspiratory and expiratory flows increases to a value that is at least the value selected for flow sensitivity (\dot{V}_{SENS}).
$\dot{V}_{E\ SET}$	Set mandatory minute volume. This value is calculated from ventilator control parameters ($f \times V_T$) and is displayed with the breath timing bar on the lower GUI screen whenever their buttons are touched.
$\dot{V}_{E\ TOT}$	Minute volume, the expiratory tidal volume normalized to unit time (L/min). The Puritan Bennett 840 Ventilator System estimates total minute volume based on the previous 60 seconds or eight breaths, whichever interval is shorter. The displayed value is compliance- and BTPS-compensated.

\dot{V}_{MAX}	Peak flow, a setting of the peak (maximum) flow of gas delivered during a VC mandatory breath. (Combined with tidal volume, flow pattern, and plateau, constant peak flow defines the inspiratory time.) To correct for compliance volume, the ventilator automatically increases the peak flow.
\dot{V}_{SENS}	Flow sensitivity, the rate of flow inspired by the patient that triggers the ventilator to deliver a mandatory or spontaneous breath (when flow triggering is selected).
V_T	Tidal volume, the volume inspired and expired with each breath. The V_T delivered by the Puritan Bennett 840 Ventilator System is an operator-set variable that determines the volume delivered to the patient during a mandatory, volume-based breath. V_T is compliance-compensated and corrected to body temperature and pressure, saturated (BTPS).
VA	Volt-amperes (unit of power).
VC	Volume control, a mandatory breath type in which the ventilator delivers an operator-set tidal volume, peak flow, and flow pattern. Available in A/C and SIMV modes, and for operator-initiated mandatory (OIM) breaths in SPONT mode.
Ventilator breathing system (VBS)	Ventilator breathing system. Includes the gas delivery components of the ventilator; the patient circuit with tubing, filters, humidifier, and other accessories; and the ventilator's expiratory metering and measurement components.
ventilator inoperative	An emergency state that the ventilator enters if it detects a hardware failure or a critical software error that could compromise safe ventilation. During a ventilator inoperative condition, the safety valve opens to allow the patient to breathe room air unassisted by the ventilator. Qualified service personnel must power up the ventilator and run EST before normal ventilation can resume.
VIM	Ventilator-initiated mandatory breath. A breath that is delivered at a time determined by the ventilator.

This page is intentionally blank.

Symbols

- ? (INFO) key, description **OP 1-12**
- O₂% alarm. *See* Low delivered O₂% alarm
- P_{PEAK} alarm. *See* Low circuit pressure alarm
- V_{E TOT} alarm. *See* Low exhaled total minute volume alarm
- V_{TE MAND} alarm. *See* Low exhaled mandatory tidal volume alarm
- V_{TE SPONT} alarm. *See* Low exhaled spontaneous tidal volume alarm
- f_{fTOT} alarm. *See* High respiratory rate alarm
- fO₂% alarm. *See* High delivered O₂% alarm
- fP_{PEAK} alarm. *See* High circuit pressure alarm
- fV_{E TOT} alarm. *See* High exhaled total minute volume alarm

Numerics

- 802 Backup Power Source (BPS). *See* BPS
- 802 BPS charging status indicator, description **OP 1-24**
- 803 BPS charging status indicator, description **OP 1-24**
- 840 Ventilator System
 - block diagram **OP 1-4**
 - compliance and approvals **OP A-12 to OP A-21**
 - functional description **OP 1-3 to OP 1-9**
 - general description **OP 1-1 to OP 1-3**
 - pneumatic schematic **OP C-1**
 - specifications **OP A-1 to OP A-60**

A

A/C mode. *See* Assist/control mode

- Abbreviations and symbols, onscreen, descriptions **OP 1-17 to OP 1-23**
- AC indicator
 - description **OP 2-8**
 - location **OP 2-8**
- AC POWER LOSS alarm, description **TR 13-23**
- ACCEPT key, description **OP 1-15**
- Accessories, part numbers **OP B-1 to OP B-6**
- Air hose assembly, part number **OP B-5, OP B-10**
- Air regulator assembly (REG2). *See* Regulator, air
- Air supply, how to connect **OP 2-12 to OP 2-13**
- Alarm log **OP 5-5 to OP 5-6**
- Alarm reset **OP 5-4 to OP 5-5**
- Alarm reset key, description **OP 1-12**
- Alarm settings, range, resolution, and accuracy **OP A-47 to OP A-52**
- Alarm silence **OP 5-2 to OP 5-3**
- Alarm silence key, description **OP 1-11**
- Alarm testing** **OP D-1 to OP D-8**
- Alarm volume key, description **OP 1-11**
- Alarm volume, how to adjust **OP 5-6**
- Alarms
 - how to test **OP D-1 to OP D-8**
 - See also name of specific alarm*
- Alarms** **TR 13-1 to TR 13-31**
 - dependent, description **TR 13-4**
 - handling strategy **TR 13-1 to TR 13-2**
 - high-urgency **OP 5-1**
 - description **TR 13-2**
 - how to respond to **OP 5-1 to OP 5-15**
 - how to set **OP 4-22 to OP 4-23**
 - log **OP 5-5 to OP 5-6**
 - low-urgency **OP 5-2**
 - description **TR 13-2**
 - medium-urgency **OP 5-2**
 - description **TR 13-2**

Index

- message format OP 5-7 to OP 5-8,
TR 13-3
- messages, list OP 5-9 to OP 5-15,
TR 13-5 to TR 13-22
- primary, description TR 13-4
- rules about how messages are
displayed TR 13-4
- urgency levels TR 13-2
- volume (dB) specifications OP A-5,
OP A-9
- ALERT, in EST TR 18-2
- ALERT, in SST, meaning OP 3-15, OP 3-
16, TR 17-1
- Altitude requirements OP A-6
- APNEA alarm, description TR 13-23
- Apnea interval (T_A) setting, function, and
range OP A-30
- Apnea settings, how to change OP 4-21
- Apnea ventilation** TR 9-1 to TR 9-5
 - description TR 12-1 to TR 12-2
 - how ventilator detects apnea TR 9-1
to TR 9-2
 - how ventilator phases in new apnea
intervals TR 9-5
 - how ventilator resets TR 9-3 to TR
9-4
 - how ventilator transitions to TR 9-3
 - key entries during TR 9-3
- Assist/control (A/C) mode** TR 6-1 to
TR 6-5
 - breath delivery in TR 6-1 to TR 6-2
 - changing to TR 6-3 to TR 6-5
 - definition TR 12-10
 - rate change during TR 6-3
- Atmospheric pressure
 - requirements OP A-6
- Atmospheric pressure transducer
 - calibration, description TR 15-7
- Auto PEEP parameter. *See* Intrinsic PEEP
- Autoclaving, steps involved in OP 7-7
- B**
- Background checks, description TR 15-
3 to TR 15-4
- Bacteria filter
 - expiratory
 - maintenance OP 7-10 to OP 7-
13
 - operation of OP 1-6
 - part numbers OP B-5, OP B-10
 - resistance check OP 7-10 to OP
7-13
 - inspiratory
 - maintenance OP 7-10 to OP 7-
13
 - operation of OP 1-6
 - part numbers OP B-6, OP B-11
 - resistance check OP 7-10 to OP
7-13
- Bag, drain
 - maintenance OP 7-14 to OP 7-16
 - part number OP B-5, OP B-10
- Barometric pressure
 - requirements OP A-6
- Base flow TR 12-5
- Batteries. *See* BPS (Backup Power Source)
- Battery charging status indicator,
description OP 1-24
- BATTERY ON indicator, description OP
1-16
- BATTERY READY indicator, description
OP 1-15
- BiLevel* mode. *See addendum to this manual*
- BPS (Backup Power Source)
 - how to recharge OP 2-6
 - operation of OP 1-7
 - specifications OP A-10
 - use of OP 2-4 to OP 2-6
- BPS on indicator, description OP 1-16
- BPS ready indicator, description OP 1-
15
- Breath delivery, overview TR 1-1 to TR
1-2
- Breath trigger type OP 4-6
- Breath trigger type setting, function and
range OP A-46
- Breath type, patient data function and
range OP A-53
- Breathing circuit. *See* Patient circuit

C

- Cable, printer OP E-6
- Calibration
 - atmospheric pressure transducer, description TR 15-7
 - exhalation valve, description TR 15-6
 - flow sensor offset, description TR 15-7
 - oxygen sensor, description TR 15-6
- Calibration (oxygen) key, description OP 1-12
- Cart, ventilator
 - how to use OP 2-26 to OP 2-29
 - part number OP B-5, OP B-10
- Checks, background, description TR 15-3 to TR 15-4
- Chemical disinfection OP 7-6 to OP 7-8
 - caution about phenol and formaldehyde-based disinfectants OP 7-6
 - steps involved in OP 7-7
- Circuit breaker
 - humidifier and compressor, location OP 2-8
 - power supply
 - description OP 2-9
 - location OP 2-8
 - trip point OP A-8
- CIRCUIT DISCONNECT alarm, description TR 13-24
- Circuit type, relationship with IBW TR 12-2 to TR 12-3
- Circuit, patient tubing. *See* Patient circuit
- Cleaning, disinfection, and sterilization OP 7-6 to OP 7-8
- Cleaning, general guidelines OP 7-6
- CLEAR key, description OP 1-14
- Collector vial
 - how to install OP 2-18 to OP 2-21
 - how to remove OP 7-14
 - maintenance OP 7-14 to OP 7-16
 - operation of OP 1-6
 - part number OP B-5, OP B-10
- Communications
 - remote alarm port OP E-2
 - pinout OP E-2
 - RS-232 port
 - description OP E-3
 - how to configure OP E-4 to OP E-5
 - pinout OP E-3
 - RS-232, commands TR 19-1 to TR 19-18
- Compliance compensation TR 4-4
- Compliance volume factor TR 4-4
- Compliance, static (C_{STAT}) parameter
 - description OP 4-28, TR 14-7 to TR 14-13
 - function and range OP A-58
- Compressor
 - description OP 1-2
 - location of connection to BDU OP 2-8
- Compressor inlet filter
 - maintenance OP 7-16 to OP 7-17
 - part number OP B-6, OP B-11
- COMPRESSOR ON indicator, description OP 1-16
- COMPRESSOR READY indicator, description OP 1-16
- Connectors, specifications OP A-5
- Console, description OP 1-11 to OP 1-24
- Constants (during rate change)
 - function and range OP A-32
 - how to set OP 4-19 to OP 4-20
- Controls and indicators OP 1-11 to OP 1-24
 - See also* Ventilator settings, Keyboard, Patient data, or name of specific control or indicator
- C_{STAT} parameter. *See* Compliance, static
- Current vent setup screen OP 4-17 to OP 4-18

Index

D

- D/Flex* filter. *See* Inspiratory filter
- D/X800* filter and collector vial. *See* Expiratory filter or Collector vial
- Data key, function of OP 1-25
- Date/time
 - display OP 4-24
 - how to change OP 4-24
- Delivered O₂% parameter
 - description TR 14-1
 - function and range OP A-53
- Dependent alarm, description TR 13-4
- Detecting and initiating exhalation** TR 3-1 to TR 3-4
- Detecting and initiating inspiration** TR 2-1 to TR 2-6
- Detecting occlusion and disconnect** TR 10-1 to TR 10-5
- DEVICE ALERT alarm, description TR 13-24
- Diagnostic codes display, function OP A-59
- Dimensions, ventilator OP A-4
- Disconnect sensitivity (D_{SENS})
 - function and range OP A-32
 - how to set OP 4-24
- Disconnect, how ventilator detects and responds TR 10-3 to TR 10-5
- Disinfection OP 7-6 to OP 7-8
 - caution about phenol and formaldehyde-based disinfectants OP 7-6
 - steps involved in OP 7-7
- Display. *See* name of specific display
- Drain bag
 - how to remove OP 7-15
 - maintenance OP 7-14 to OP 7-16
 - part number OP B-5, OP B-10
- D_{SENS} setting. *See* Disconnect sensitivity

E

- Electrical specifications OP A-8 to OP A-11

- End expiratory pressure (PEEP) parameter
 - description TR 14-2
- End inspiratory pressure (P_{I END}) parameter
 - description TR 14-2 to TR 14-3
 - function and range OP A-54
- Environmental requirements OP A-6
- E_{SENS} setting. *See* Expiratory sensitivity
- EST. *See* Extended self test
- Exhalation
 - backup limits
 - high circuit pressure limit TR 3-4
 - high ventilator pressure limit TR 3-4
 - time limit TR 3-4
 - how ventilator detects and initiates TR 3-1 to TR 3-4
 - initiation methods
 - airway pressure method TR 3-2 to TR 3-3
 - end-inspiratory flow method TR 3-2
 - time-cycling TR 3-1
 - restricted phase of TR 2-1
- Exhalation filter latch open indicator, description OP 1-27
- Exhalation system, operation of OP 1-7
- Exhalation valve
 - calibration, description TR 15-6
 - operation of OP 1-7
- Exhaled minute volume (V̇_{E TOT})
 - parameter
 - description TR 14-3 to TR 14-4
 - function and range OP A-54
- Exhaled tidal volume (V_{TE}) parameter
 - description TR 14-4
 - function and range OP A-55
- EXP PAUSE key, description OP 1-13
- Expiratory filter
 - maintenance OP 7-10 to OP 7-13
 - operation of OP 1-6
 - part numbers OP B-5, OP B-10
 - resistance check OP 7-10 to OP 7-13

- Expiratory pause maneuvers OP 4-25 to OP 4-26
- Expiratory sensitivity (E_{SENS}) setting
description TR 12-3 to TR 12-4
function and range OP A-32
- Expiratory time (T_E) setting
description TR 12-4
function and range OP A-33
- Extended self test (EST)** TR 18-1 to TR 18-3
failure handling TR 18-3
results TR 18-2 to TR 18-3
safety considerations TR 18-3
- ## F
- f setting. *See* Respiratory rate setting
- Factor, compliance volume TR 4-4
- FAILURE, in EST TR 18-2
- FAILURE, in SST TR 17-2
- FAILURE, in SST, meaning OP 3-15, OP 3-16
- Faults, system
definition TR 15-1
how ventilator detects and responds TR 15-2
- Filter
compressor inlet
maintenance OP 7-16 to OP 7-17
part number OP B-6, OP B-11
- expiratory
maintenance OP 7-10 to OP 7-13
operation of OP 1-6
part numbers OP B-5, OP B-10
resistance check OP 7-10 to OP 7-13
- inspiratory
maintenance OP 7-10 to OP 7-13
operation of OP 1-6
part numbers OP B-6, OP B-11
resistance check OP 7-10 to OP 7-13
- Flex arm
how to install OP 2-22 to OP 2-23
part number OP B-3, OP B-8, OP B-13
- Flow pattern setting
description TR 12-4
function and range OP A-33
- Flow sensitivity (\dot{V}_{SENS}) setting
description TR 12-4 to TR 12-5
function and range OP A-33
in flow triggering TR 2-3 to TR 2-5
- Flow sensor offset calibration,
description TR 15-7
- Flow triggering (\dot{V} -TRIG)
description OP 1-5, TR 2-3 to TR 2-5
- FREEZE function, in Graphics OP 6-5 to OP 6-6
- f_{TOT} parameter. *See* Total respiratory rate
- ## G
- Gold standard test circuit (for EST) TR 15-5, TR 18-1
part number OP B-6, OP B-11
- Graphic user interface (GUI)
description of controls and indicators OP 1-11 to OP 1-24
how structured OP 4-2
- Graphics**
curve types OP 6-1
how to print OP 6-7
FREEZE function OP 6-5 to OP 6-6
setup OP 6-3 to OP 6-4
Shadow trace OP 6-4
when not accessible OP 6-8
- GUI (loss of) indicator, description OP 1-16
- GUI symbols and abbreviations,
descriptions OP 1-17 to OP 1-23

Index

H

Hardware monitoring circuitry,
description TR 15-4 to TR 15-5

High circuit pressure (fP_{PEAK}) alarm
description TR 13-25
function and range OP A-47

High delivered O₂% ($fO_2\%$) alarm
description TR 13-26
function and range OP A-47

High exhaled minute volume ($f\dot{V}_{E\text{TOT}}$)
alarm
description TR 13-26
function and range OP A-48

High exhaled tidal volume (fV_{TE}) alarm
description TR 13-27
function and range OP A-49

High inspired tidal volume (fV_{TI} , V_{TI}
MAND, $V_{TI\text{SPONT}}$) alarm
description TR 13-27 to TR 13-28

High respiratory rate (ff_{TOT}) alarm
description TR 13-28
function and range OP A-49

High spontaneous inspiratory time limit
($fT_{I\text{SPONT}}$) setting
description OP 4-34, TR 12-5
function and range OP A-33

High-urgency alarm indicator,
description OP 1-15

HIP alarm. *See* High circuit pressure alarm

Hose assembly
air, part number OP B-5, OP B-10
oxygen, part number OP B-5, OP B-10

Hose, gold standard test (for EST), part
number OP B-6, OP B-11

How to handle alarms OP 5-1 to OP 5-15

How to run short self test OP 3-1 to
OP 3-16

How to view graphics OP 6-1 to OP 6-8

Humidification type setting TR 12-6 to
TR 12-7
function and range OP A-34

how to change OP 4-23 to OP 4-25

Humidifier mounting kit, part number
OP B-6

Humidifier volume setting, function and
range OP A-34

Humidifier, how to install OP 2-24 to
OP 2-26

I

I:E ratio (I:E) parameter
description TR 14-4
function and range OP A-55

I:E ratio setting
description TR 12-7
function and range OP A-36

IBW setting OP 4-5

IBW setting. *See* Ideal body weight

Ideal body weight (IBW) setting
function and range OP A-35
relationship with circuit type OP 4-15, TR 12-2 to TR 12-3
table of values OP 4-12

Idle mode TR 10-4

INCREASE O₂ min key or 100% O₂/CAL
2 min key, description OP 1-12

Indicator. *See name of specific indicator*

INFO key, description OP 1-12

INSP PAUSE key, description OP 1-14

Inspiration
detecting and initiating TR 2-1 to
TR 2-6
triggers
flow triggering (\dot{V} -TRIG) TR 2-3
to TR 2-5
operator triggering (MANUAL
INSP) TR 2-6
pressure triggering (P-TRIG) TR
2-2 to TR 2-3
time-cycled TR 2-5 to TR 2-6

INSPIRATION TOO LONG alarm,
description TR 13-28

Inspiratory filter
maintenance OP 7-10 to OP 7-13
operation of OP 1-6

- part numbers OP B-6, OP B-11
- resistance check OP 7-10 to OP 7-13
- Inspiratory module
 - operation of OP 1-5 to OP 1-6
 - oxygen sensor replacement OP 7-19 to OP 7-25
- Inspiratory pause maneuvers OP 4-26 to OP 4-27
- Inspiratory pressure (P_I) setting
 - description TR 12-7
 - function and range OP A-36
- Inspiratory time (T_I) setting
 - description TR 12-8
 - function and range OP A-37
- Installation
 - collector vial OP 2-18 to OP 2-21
 - flex arm OP 2-22 to OP 2-23
 - humidifier OP 2-24 to OP 2-26
 - patient circuit OP 2-14 to OP 2-21
 - to electrical supply OP 2-6
 - to oxygen and air supplies OP 2-12 to OP 2-13
- Intrinsic (auto) PEEP ($PEEP_I$) parameter
 - description TR 14-5
 - function and range OP A-56
- Introduction to breath delivery** TR 1-1 to TR 1-2

K

- Key. *See name of specific key*
- Keyboard, description OP 1-11 to OP 1-15
- Knob, description OP 1-14

L

- Labels and symbols, descriptions OP 1-23 to OP 1-33
- Leakage current, specifications OP A-9
- Light. *See name of specific light*
- LIP alarm. *See Low circuit pressure alarm*

- Lock key (for screen), description OP 1-11
- Log, alarm OP 5-5 to OP 5-6
- Loss of GUI indicator, description OP 1-16
- LOW BATTERY alarm, after ventilator storage OP 2-6
- Low circuit pressure ($-P_{PEAK}$) alarm
 - description TR 13-29
 - function and range OP A-52
- Low delivered $O_2\%$ ($-O_2\%$) alarm
 - description TR 13-29 to TR 13-30
 - function and range OP A-47
- Low exhaled mandatory tidal volume ($-V_{TE\ MAND}$) alarm
 - description TR 13-30
 - function and range OP A-50
- Low exhaled spontaneous tidal volume ($-V_{TE\ SPONT}$) alarm
 - description TR 13-30 to TR 13-31
 - function and range OP A-52
- Low exhaled total minute volume ($-V_{E\ TOT}$) alarm
 - description TR 13-31
 - function and range OP A-51
- Low-urgency alarm indicator,
 - description OP 1-15
- Lung mechanics. *See Pause mechanics*

M

- maintenance and service
 - preventive OP 7-25 to OP 7-27
 - schedule OP 7-10 to OP 7-12
 - See also 800 Series Ventilator System Service Manual*
 - See also name of specific part*
- Mandatory breath delivery** TR 4-1 to TR 4-5
- Mandatory breath type setting
 - OP 4-5
 - description TR 12-8 to TR 12-11
 - function and range OP A-37
- Mandatory breaths

Index

- BTPS compensation for volume-based TR 4-5
 - comparison of pressure- and volume-based TR 4-1 to TR 4-3
 - compliance compensation for volume-based TR 4-3 to TR 4-5
 - description TR 4-1 to TR 4-5
 - mandatory inspiration (MANUAL INSP), description TR 4-5
 - Maneuvers
 - expiratory pause OP 4-25 to OP 4-26
 - inspiratory pause OP 4-26 to OP 4-27
 - MANUAL INSP (manual inspiration), description TR 4-5
 - MANUAL INSP key, description OP 1-12
 - Manufacturer's declaration OP A-13 to OP A-21
 - Mean circuit pressure (P_{MEAN}) parameter
 - description TR 14-5
 - function and range OP A-56
 - Mechanics, pause. *See* Pause mechanics
 - Medium-urgency alarm indicator, description OP 1-15
 - Messages, alarm, list OP 5-9 to OP 5-15
 - Mode
 - assist/control (A/C)
 - breath delivery in TR 6-1 to TR 6-2
 - changing to TR 6-3 to TR 6-5
 - definition TR 12-10
 - description TR 6-1 to TR 6-5
 - rate change during TR 6-3
 - spontaneous (SPONT)
 - breath delivery in TR 8-1
 - changing to TR 8-1
 - definition TR 12-10
 - description TR 8-1
 - synchronous intermittent mandatory ventilation (SIMV)
 - apnea ventilation in TR 7-4
 - breath delivery in TR 7-2 to TR 7-4
 - changing to TR 7-5 to TR 7-6
 - definition TR 12-11
 - description TR 7-1 to TR 7-7
 - rate change during TR 7-7
 - Mode setting
 - OP 4-5
 - description TR 12-8 to TR 12-11
 - function and range OP A-38
 - Monitoring circuitry, description TR 15-4 to TR 15-5
 - More Alarms button, function OP 5-7, TR 13-3
 - More settings screen OP 4-24
- ## N
- New patient settings screen OP 4-4 to OP 4-6
 - NIV. *See* Non-invasive ventilation
 - Non-invasive ventilation
 - alarms OP 4-35 to OP 4-36
 - breathing interfaces OP 4-29
 - how to set up OP 4-30 to OP 4-33
 - intended use OP 4-29
 - switching from invasive Vent Type OP 4-36
 - switching to invasive Vent Type OP 4-37
 - Normal ventilator operation indicator, description OP 1-15
 - Nurse's call. *See* Remote alarm port
- ## O
- O₂ sensor. *See* Oxygen sensor
 - O₂% (delivered) parameter
 - description TR 14-1
 - function and range OP A-53
 - O₂% setting
 - description TR 12-11 to TR 12-12
 - function and range OP A-39
 - Occlusion status cycling (OSC), description TR 10-2

- Occlusion, how ventilator detects and responds **TR 10-1 to TR 10-3**
- OIM breaths. *See* Operator-initiated mandatory breaths
- Ongoing background checks. *See* Background checks
- Onscreen symbols and abbreviations, descriptions **OP 1-17 to OP 1-23**
- Operator-initiated mandatory (OIM) breaths, description **TR 2-6**
- OSC (occlusion status cycling), description **TR 10-2**
- Other Screens button **OP 4-23 to OP 4-25**
- OUTCOME
in EST Single EST test results **TR 18-2**
- OVERRIDDEN, in EST **TR 18-2**
- OVERRIDDEN, in SST **TR 17-2**
- Oxygen calibration key, description **OP 1-12**
- Oxygen hose assembly, part number **OP B-5, OP B-10**
- Oxygen regulator assembly (REG1). *See* Regulator, oxygen
- Oxygen sensor
calibration test **OP D-8**
calibration, description **TR 15-6**
how to enable/disable **OP 4-24 to OP 4-25**
maintenance **OP 7-17 to OP 7-25**
operation of **OP 1-5**
part number **OP B-6, OP B-11**
- Oxygen supply, how to connect **OP 2-12 to OP 2-13**
- P**
- Part numbers** **OP B-3 to OP B-13**
- Pasteurization, steps involved in **OP 7-7 to OP 7-8**
- Patient circuit
how to install **OP 2-14 to OP 2-21**
operation of **OP 1-6**
part numbers **OP B-3 to OP B-5, OP B-8 to OP B-10**
specifications **OP A-23 to OP A-26**
- Patient circuit disconnect, how ventilator detects and responds **TR 10-3 to TR 10-5**
- Patient circuit occlusion, how ventilator detects and responds **TR 10-1 to TR 10-3**
- Patient circuit type setting, function and range **OP A-39**
- Patient data** **TR 14-1 to TR 14-14**
- Patient data, range, resolution, and accuracy **OP A-53 to OP A-59**
- Patient problems
definition **TR 15-1**
how ventilator detects and responds **TR 15-1**
- Patient setup **OP 4-3 to OP 4-15**
- Patient-initiated mandatory (PIM) breaths, definition **TR 2-2**
- Pause mechanics
expiratory pause, description **OP 1-13**
inspiratory pause, description **OP 1-14**
intrinsic (auto) PEEP ($PEEP_I$) and total PEEP ($PEEP_{TOT}$), description **TR 14-5**
plateau pressure (P_{PL}), description **TR 14-6**
static compliance (C_{STAT}) and static resistance (R_{STAT}), description **OP 4-28, TR 14-7 to TR 14-13**
- PAV+ software option. *See also* Proportional Assist (PA) **OP A-29**
- Peak circuit pressure (P_{PEAK}) parameter
description **TR 14-5 to TR 14-6**
function and range **OP A-56**
- Peak inspiratory flow (\dot{V}_{MAX}) setting
description **TR 12-12**
function and range **OP A-40**
- PEEP (positive end expiratory pressure) setting
description **TR 12-12 to TR 12-13**
function and range **OP A-41**

Index

- PEEP parameter. *See* End expiratory pressure
- PEEP restoration TR 12-13
- PEEP_I parameter. *See* Intrinsic (auto) PEEP parameter
- PEEP_{TOT} parameter. *See* Total PEEP
- Periodic maintenance OP 7-8 to OP 7-27
 - schedule OP 7-10 to OP 7-12
- Phasing in setting changes** TR 11-1
- P_I END parameter. *See* End inspiratory pressure
- P_I setting. *See* Inspiratory pressure setting
- PIM breaths. *See* Patient-initiated mandatory breaths
- Plateau pressure (P_{PL}) parameter
 - description TR 14-6
 - function and range OP A-56
- Plateau time (T_{PL}) setting
 - description TR 12-13
 - function and range OP A-41
- P_{MEAN} parameter. *See* Mean circuit pressure
- Pneumatic schematic** OP C-1
- Port
 - remote alarm OP E-2
 - pinout OP E-2
 - RS-232 OP E-3
 - pinout OP E-3
- Positive end expiratory pressure. *See* PEEP
- Potential equalization (ground) point
 - description OP 1-24
 - location OP 2-8
- Power cord, part number OP B-5, OP B-10
- Power input range OP A-8
- Power on self test (POST)** TR 16-1 to TR 16-5
 - difference between short and full-length POST TR 16-3
 - fault handling TR 16-4
 - following power interruptions TR 16-3
 - POST characteristics TR 16-2 to TR 16-3
 - safety considerations TR 16-1
 - system interface TR 16-4 to TR 16-5
 - user interface TR 16-5
- Power specifications OP A-8 to OP A-11
- Power supply circuit breaker,
 - description OP 2-9
- Power supply, operation of OP 1-7
- Power switch
 - description OP 2-8
 - location OP 2-8
- P_{PEAK}. *See* Peak circuit pressure
- P_{PL} parameter. *See* Plateau pressure
- Pressure sensitivity (P_{SENS}) setting
 - description TR 12-14
 - function and range OP A-41
- Pressure support (P_{SUPP}) setting
 - description TR 12-14
 - function and range OP A-42
- Pressure transducers, operation of OP 1-7
- Pressure triggering (P-TRIG)
 - description OP 1-5, TR 2-2 to TR 2-3
 - factors influencing speed of breath initiation TR 2-2
 - where pressure is monitored TR 2-2
- Preventive Maintenance** OP 7-1 to OP 7-27
 - performed by operator OP 7-8 to OP 7-25
 - performed by service personnel OP 7-25 to OP 7-26
 - schedule OP 7-10 to OP 7-12
- Primary alarm, description TR 13-4
- Printers OP E-5
- Printing graphics OP 6-7
- PROCEDURE ERROR alarm, description TR 13-31
- Proportional Assist (PA) OP 4-6, OP A-44
- Proportional solenoid valves (PSOLs),
 - operation of OP 1-6
- P_{SENS} setting. *See* Pressure sensitivity
- P_{SUPP} setting. *See* Pressure support setting

P-TRIG. *See* Pressure triggering
 Puritan Bennett Technical Services,
 phone number **OP 1-3**

R

Rapid shallow breathing index (f/V_T),
 function and range **OP A-57**
Re/Flex filter. *See* Inspiratory filter
Re/X800 filter. *See* Expiratory filter
 Real time waveforms **OP E-5**
 Recommended limits **OP A-28**
 REG1. *See* Regulator, oxygen
 REG2. *See* Regulator, air
 Regulator, air **OP A-7**
 Regulator, oxygen **OP A-7**
Remote alarm and RS-232 ports **OP E-1**
 to **OP E-6**
 Remote alarm port **OP E-2**
 pinout **OP E-2**
 Repacking **OP 7-27**
 RESET (alarm) key, description **OP 1-12**
 Resistance, static (R_{STAT}) parameter
 description **OP 4-28**, **TR 14-7** to **TR 14-13**
 function and range **OP A-58**
 Respiratory mechanics. *See* Pause
 mechanics
 Respiratory rate (f) setting
 description **TR 12-15**
 function and range **OP A-42**
 Restricted phase of exhalation **OP 1-12**,
TR 2-1
 Rise time % setting
 description **TR 12-15** to **TR 12-16**
 function and range **OP A-43**
RS-232 commands **TR 19-1** to **TR 19-18**
RS-232 port
 description **OP E-3**
 how to configure **OP E-4** to **OP E-5**
 pinout **OP E-3**
 R_{STAT} parameter. *See* Resistance, static

S

Safety net **TR 15-1** to **TR 15-7**
 Safety valve open (SVO) state,
 description **OP 1-8**, **TR 15-2**
 SAFETY VALVE OPEN indicator,
 description **OP 1-15**, **OP 1-16**
 Safety valve, operation of **OP 1-6**
 Safety ventilation
 description **TR 12-16** to **TR 12-17**
 settings during **OP A-43**
 Schedule of preventive maintenance
OP 7-10 to **OP 7-12**
 Screen
 current vent setup **OP 4-17** to **OP 4-18**
 more settings **OP 4-24**
 new patient settings **OP 4-4** to **OP 4-6**
 normal ventilation, illustration **OP 4-10**
 ventilator startup **OP 4-3** to **OP 4-4**
 illustration **OP 4-3**
 SCREEN key, description **OP 1-11**
 Screen lock key, description **OP 1-11**
 Self tests. *See* Power on self test (POST),
 Short self test (SST), or Extended self
 test (EST)
 Sensor, oxygen (OS)
 calibration **TR 15-6**
 how to enable/disable **OP 4-24** to
OP 4-25
 life expectancy **OP A-7**
 maintenance **OP 7-17** to **OP 7-25**
 part number **OP B-6**, **OP B-11**
 replacement **OP 7-19** to **OP 7-25**
 Serial communications
 commands **TR 19-1** to **TR 19-18**
 description of port **OP E-3**
 how to configure **OP E-4** to **OP E-5**
 pinout of port **OP E-3**
 Service **OP 7-1** to **OP 7-27**
*See also 800 Series Ventilator System
 Service Manual*

Index

- Service (TEST) button, description OP 1-26
- Service and repair
 - repair guidelines OP 7-19 to OP 7-20
- Service manual, part number OP B-6, OP B-11
- Setup, patient OP 4-3 to OP 4-15
- Setup, ventilator OP 2-1 to OP 2-29
- Shadow trace OP 6-4
- Short POST, difference between it and full-length POST TR 16-3
- Short self test (SST)** TR 17-1 to TR 17-2
 - how to interpret test results OP 3-15 to OP 3-16
 - how to run OP 3-1 to OP 3-16
 - list of tests OP 3-9 to OP 3-13
 - test results, description OP 3-14
 - when to run OP 3-2 to OP 3-3
 - components and requirements OP 3-4
 - procedure OP 3-5 to OP 3-8
- Silence key (for alarm), description OP 1-11
- SIMV mode. *See* Synchronous intermittent mandatory ventilation mode
- Soft bound. *See* Recommended limits
- Software options OP A-29
- Software revision level display. *See* Ventilator configuration OP A-60
- Specifications** OP A-1 to OP A-60
 - air/oxygen regulator bleed OP A-5, OP A-7
 - alarm volume OP A-5, OP A-9
 - altitude OP A-6
 - atmospheric pressure OP A-6
 - bacteria filter efficiency OP A-25
 - BPS OP A-10
 - dimensions OP A-4
 - electrical OP A-8 to OP A-11
 - environmental OP A-6
 - flow range OP A-5, OP A-7
 - gas inlet supplies OP A-6
 - gas mixing system OP A-7
 - leakage current OP A-9
 - maximum limited pressure OP A-21
 - maximum working pressure OP A-21
 - measuring and display devices OP A-22
 - minute volume capability OP A-22
 - operating pressure range OP A-5, OP A-7
 - oxygen sensor life OP A-7
 - patient circuit OP A-23 to OP A-26
 - physical OP A-2 to OP A-5
 - pneumatic, ventilator OP A-6 to OP A-7
 - power OP A-8 to OP A-11
 - power input range OP A-8
 - power supply (mains) circuit breaker OP A-8
 - technical OP A-21 to OP A-25
 - temperature OP A-6
 - ventilator connectors OP A-5
 - weight OP A-3
- SPONT mode. *See* Spontaneous mode
- Spontaneous (SPONT) mode** TR 8-1
 - breath delivery characteristics TR 5-1 to TR 5-2
 - definition TR 12-10
- Spontaneous breath delivery** TR 5-1 to TR 5-2
- Spontaneous breath type setting
 - OP 4-6
 - description TR 12-17 to TR 12-18
 - function and range OP A-44
- Spontaneous inspiratory time ($T_{I\text{ SPONT}}$), function and range OP A-57
- Spontaneous minute volume ($\dot{V}_{E\text{ SPONT}}$)
 - parameter
 - description TR 14-6 to TR 14-7
 - function and range OP A-57
- Spontaneous percent inspiratory time (T_I/T_{TOT}), function and range OP A-58
- SST button, location OP 3-6
- SST. *See* Short self test

- Static compliance (C_{STAT}) parameter
 description OP 4-28, TR 14-7 to TR 14-13
 function and range OP A-58
- Static mechanics. *See* Pause mechanics
- Static resistance (R_{STAT}) parameter
 description OP 4-28, TR 14-7 to TR 14-13
 function and range OP A-58
- Steam autoclaving, steps involved in OP 7-7
- Sterilization OP 7-6 to OP 7-8
- Storage, requirements OP 7-27
- Support arm
 how to install OP 2-22 to OP 2-23
 part number OP B-3, OP B-8, OP B-13
- SVO state. *See* Safety valve open state
- Switch, power
 description OP 2-8
 location OP 2-8
- symbol definitions, displaying OP 4-9
- Symbols and abbreviations, onscreen, descriptions OP 1-17 to OP 1-23
- Symbols and labels, descriptions OP 1-23 to OP 1-33
- Synchronous intermittent mandatory ventilation (SIMV) mode** TR 7-1 to TR 7-7
 apnea ventilation in TR 7-4
 breath delivery in TR 7-2 to TR 7-4
 changing to TR 7-5 to TR 7-6
 definition TR 12-11
 rate change during TR 7-7
- System faults
 definition TR 15-1
 how ventilator detects and responds TR 15-2
- T**
- Target volume (V_T) setting
 function and range OP A-45
- T_E setting. *See* Expiratory time setting
- Technical Services, Puritan Bennett,
 phone number OP 1-3
- TEST (service) button, description OP 1-26
- Test lung, part number OP B-5, OP B-10
- Testing
 alarms OP D-1 to OP D-8
 oxygen sensor calibration OP D-8
- T_I setting. *See* Inspiratory time setting
- Tidal volume (V_T) setting
 description TR 12-18
 function and range OP A-45
- Time/date
 display OP 4-24
 how to change OP 4-24
- Total PEEP ($PEEP_{TOT}$) parameter
 description TR 14-5
 function and range OP A-59
- Total respiratory rate (f_{TOT}) parameter
 description TR 14-13 to TR 14-14
 function and range OP A-59
- T_{PL} setting. *See* Plateau time setting
- Transducers, pressure, operation of OP 1-7
- Trap, water, in-line, maintenance OP 7-16
- Tubing circuit. *See* Patient circuit
- U**
- User interface (UI). *See* Graphic user interface (GUI) or GUI
- V**
- Valve, exhalation
 calibration TR 15-6
 operation of OP 1-7
- $\dot{V}_{E\ SPONT}$ parameter. *See* Spontaneous minute volume
- $\dot{V}_{E\ TOT}$. *See* Exhaled minute volume
- VENT INOP indicator, description OP 1-15, OP 1-16

Index

- Vent Type
 - description TR 12-18 to TR 12-19
 - function and range OP A-46
- Vent Type setting OP 4-5
- Ventilator breathing circuit. *See* Patient circuit
- Ventilator configuration, function OP A-60
- Ventilator control parameters, how to change OP 4-16
- Ventilator inoperative condition OP 1-8
- Ventilator inoperative indicator,
 - description OP 1-15, OP 1-16
- Ventilator inoperative test, description TR 15-6
- Ventilator settings** TR 12-1 to TR 12-18
 - apnea ventilation TR 12-1 to TR 12-2
 - breath trigger type
 - function and range OP A-46
 - disconnect sensitivity (D_{SENS})
 - description TR 12-3
 - function and range OP A-32
 - expiratory sensitivity (E_{SENS})
 - description TR 12-3 to TR 12-4
 - expiratory sensitivity (E_{SENS})
 - function and range OP A-32
 - expiratory time (T_E)
 - description TR 12-4
 - expiratory time (T_E)
 - function and range OP A-33
 - flow pattern
 - description TR 12-4
 - function and range OP A-33
 - flow sensitivity (\dot{V}_{SENS})
 - description TR 12-4 to TR 12-5
 - flow sensitivity (\dot{V}_{SENS})
 - function and range OP A-33
 - high spontaneous inspiratory time limit ($\uparrow T_{I\ SPONT}$)
 - description TR 12-5
 - function and range OP A-33
 - how changes are phased in TR 11-1
 - humidification type
 - description TR 12-6 to TR 12-7
 - function and range OP A-34
 - humidifier volume
 - function and range OP A-34
 - I:E ratio
 - description TR 12-7
 - function and range OP A-36
 - ideal body weight (IBW)
 - function and range OP A-35
 - how to determine OP 4-11
 - relationship with circuit type TR 12-2 to TR 12-3
 - inspiratory pressure (P_I)
 - description TR 12-7
 - inspiratory pressure (P_I)
 - function and range OP A-36
 - inspiratory time (T_I)
 - description TR 12-8
 - inspiratory time (T_I)
 - function and range OP A-37
 - mandatory breath type
 - description TR 12-8 to TR 12-11
 - function and range OP A-37
 - mode
 - description TR 12-8 to TR 12-11
 - function and range OP A-38
- O₂%
 - description TR 12-11 to TR 12-12
 - function and range OP A-39
- patient circuit type
 - function and range OP A-39
 - relationship with IBW TR 12-2 to TR 12-3
- peak inspiratory flow (\dot{V}_{MAX})
 - description TR 12-12
 - function and range OP A-40
- PEEP (positive end expiratory pressure)
 - description TR 12-12 to TR 12-13
 - function and range OP A-41
- plateau time (T_{PI})
 - description TR 12-13

- function and range **OP A-41**
 - pressure sensitivity (P_{SENS})
 - description **TR 12-14**
 - function and range **OP A-41**
 - pressure support (P_{SUPP})
 - description **TR 12-14**
 - function and range **OP A-42**
 - respiratory rate (f)
 - description **TR 12-15**
 - function and range **OP A-42**
 - rise time %
 - description **TR 12-15 to TR 12-16**
 - function and range **OP A-43**
 - safety ventilation
 - description **TR 12-16 to TR 12-17**
 - settings during **OP A-43**
 - spontaneous breath type
 - description **TR 12-17 to TR 12-18**
 - function and range **OP A-44**
 - tidal volume (V_T)
 - description **TR 12-18**
 - tidal volume (V_T)
 - function and range **OP A-45**
 - vent type
 - description **TR 12-18 to TR 12-19**
 - function and range **OP A-46**
 - Ventilator settings, ranges, resolutions, and accuracies **OP A-29 to OP A-46**
 - Ventilator setup, how to change **OP 4-17 to OP 4-18**
 - Ventilator startup screen **OP 4-3 to OP 4-4**
 - illustration **OP 4-3**
 - Ventilator-initiated mandatory (VIM)
 - breath, description **TR 2-5 to TR 2-6**
 - Vial, collector
 - how to install **OP 2-18 to OP 2-21**
 - maintenance **OP 7-14 to OP 7-16**
 - operation of **OP 1-6**
 - part number **OP B-5, OP B-10**
 - VIM. *See* Ventilator-initiated mandatory breath
 - \dot{V}_{MAX} setting. *See* Peak inspiratory flow setting
 - VOL (alarm volume) key, description **OP 1-11**
 - Volume key (for alarm), description **OP 1-11**
 - \dot{V}_{SENS} setting. *See* Flow sensitivity setting
 - V_T setting. *See* Tidal volume
 - V_{TE} . *See* Exhaled tidal volume
 - \dot{V} -TRIG. *See* Flow triggering
- ## W
- Wall Air Water Trap kit, part number **OP B-6**
 - Water trap, in-line, maintenance **OP 7-16**
 - Weight, ventilator **OP A-3**

This page is intentionally blank.