



AVEA[®] ventilator systems

Operator's manual



This document is protected by United States and International Copyright laws.

This document may not be copied, reproduced, translated, stored in a retrieval system, transmitted in any form, or reduced to any electronic medium or machine-readable form, in whole or in part, without the written permission of CareFusion. Information in this document is subject to change without notice.

This document is for informational purposes only and should not be considered as replacing or supplementing the terms and conditions of the License Agreement.

© 2010–2011 CareFusion Corporation or one of its subsidiaries. All rights reserved. Avea is a registered trademark of CareFusion Corporation or one of its subsidiaries. All other trademarks are property of their respective owners.

USA

CareFusion
22745 Savi Ranch Parkway
Yorba Linda, California 92887-4668
USA

800.231.2466 tel
+1.714.283.2228 tel

Authorized European Representative

CareFusion Germany 234 GmbH
Leibnizstrasse 7
97204 Hoechberg
Germany

+49.931.4972.0 tel
+49.931.4972.423 fax

carefusion.com



Literature number: L2786 Revision M

Revision History

Date	Revision	Changes
September 2005	A	Release
May 2006	B	Removed references to the Plus model
		Removed "non-operational" from figure 2-19
		Added a note regarding the setting of Peak Inspiratory Pressure
		Added Ppeak to the list of alert messages
December 2006	C	Updated the Primary Controls table
		Added NCPAP to the troubleshooting table
		Updated the Rate specification
		Added the chapter "Infant NCPAP"
February 2007	D	Updated the figure and added a description of the balloon size and type selection
		Added a note regarding the date and time
		Added Addendums Filter/Water Trap, Processing Instructions, Sterilization, L2860-101, L3004A, L3082A, L2889A, L3031A
September, 2008	E	Release of Volumetric Capnography
February 2010	F	Revised the manual to comply with the revised Medical Device Directive 2007/42/EC.
February 2010	G	Rebranded to the CareFusion style.
June 2010	H	Revised the Circuit Resistance Test regarding the use of ET tubes. Added a bullet under Warnings: Routine assessment of oxygenation and ventilation should be performed when a patient is receiving respiratory support.
January 2011	J	Changed the logo and company references to VIASYS.
January 2011	K	Changed the logo and company references to CareFusion.
June 2011	L	Added content for Volume Guarantee and Nasal Intermittent Mandatory Ventilation.
July 2011	M	Removed the first note from the section "Specific Controls" regarding the flow cycling of breaths.

Warranty

THE AVEA[®] ventilator systems are warranted to be free from defects in material and workmanship and to meet the published specifications for Two (2) years or 16,000 hours, whichever occurs first.

The liability of CareFusion (referred to as the Company) under this warranty is limited to replacing, repairing or issuing credit, at the discretion of the Company, for parts that become defective or fail to meet published specifications during the warranty period; the Company will not be liable under this warranty unless (A) the Company is promptly notified in writing by Buyer upon discovery of defects or failure to meet published specifications; (B) the defective unit or part is returned to the Company, transportation charges prepaid by Buyer; (C) the defective unit or part is received by the Company for adjustment no later than four weeks following the last day of the warranty period; and (D) the Company's examination of such unit or part shall disclose, to its satisfaction, that such defects or failures have not been caused by misuse, neglect, improper installation, unauthorized repair, alteration or accident.

Any authorization of the Company for repair or alteration by the Buyer must be in writing to prevent voiding the warranty. In no event shall the Company be liable to the Buyer for loss of profits, loss of use, consequential damage or damages of any kind based upon a claim for breach of warranty, other than the purchase price of any defective product covered hereunder.

The Company warranties as herein and above set forth shall not be enlarged, diminished or affected by, and no obligation or liability shall arise or grow out of the rendering of technical advice or service by the Company or its agents in connection with the Buyer's order of the products furnished hereunder.

Limitation of Liabilities

This warranty does not cover normal maintenance such as cleaning, adjustment or lubrication and updating of equipment parts. This warranty shall be void and shall not apply if the equipment is used with accessories or parts not manufactured by the Company or authorized for use in writing by the Company or if the equipment is not maintained in accordance with the prescribed schedule of maintenance.

The warranty stated above shall extend for a period of TWO (2) years from date of shipment or 16,000 hours of use, whichever occurs first, with the following exceptions:

1. Components for monitoring of physical variables such as temperature, pressure, or flow are warranted for ninety (90) days from date of receipt.
2. Elastomeric components and other parts or components subject to deterioration, over which the Company has no control, are warranted for sixty (60) days from date of receipt.
3. Internal batteries are warranted for ninety (90) days from the date of receipt.

The foregoing is in lieu of any warranty, expressed or implied, including, without limitation, any warranty of merchantability, except as to title, and can be amended only in writing by a duly authorized representative of the Company.

Contents

Chapter 1:	Introduction	1
Chapter 2:	Unpacking & Setup	7
	Ventilator Assembly & Physical Setup	7
	Setting Up the Front of the Ventilator	9
	Front Panel Connections	17
	Setting Up the Rear of the Ventilator	24
	User Verification Test.....	39
	AVEA User Verification Test Checklist.....	45
	AVEA Troubleshooting.....	46
Chapter 3:	Ventilator Operation.....	51
	Membrane Buttons and LEDs.....	51
	Patient Setup	59
	Ventilation Setup.....	61
	Setting the Ventilation Breath Type and Mode.....	66
	Volume Guarantee (VG).....	67
	Primary Breath Controls.....	90
	Advanced Settings	96
	Independent Lung Ventilation (ILV)	104
Chapter 4:	Monitors, Displays and Maneuvers	105
	Graphic Displays.....	105
	Digital Displays	124
	Main Screen Displays	130
Chapter 5:	Volumetric Capnography.....	133
	Theory of Operation	133
	Setup	134
	Settings and Monitored Values	137
	Alarms.....	141
	Maneuvers	142
	Zeroing the CAPNOSTAT 5.....	144
	Checking the Accuracy of the CAPNOSTAT 5	146
Chapter 6:	Infant Non-invasive Ventilation.....	149
	Nasal CPAP (nCPAP).....	149
	Nasal Intermittent Mandatory Ventilation (nIMV)	155
Chapter 7:	Alarms and Indicators.....	167
	Status Indicators	167
	Messages	169
	Alarms.....	170
	Alarm Controls	171
	Alarm Types.....	172
	Nasal CPAP / Nasal IMV Alarms	181
	Volume Guarantee Alarms.....	184
Chapter 8:	Maintenance and Cleaning.....	187
	Cleaning and Sterilization	187
	Recommended Periodic Maintenance	190
	Battery Care.....	191
	Fuses	194

Appendix A:	Contact & Ordering Information	197
	How to Call for Service	197
	Ordering Parts	198
Appendix B:	Specifications	201
	Pneumatic Supply.....	201
	Electrical Supply	201
	Data Input / Output	202
	Atmospheric & Environmental Specifications	208
	Physical Dimensions	209
	Accessories	209
Appendix C:	Pneumatic Diagram	211
Appendix D:	Monitor Ranges and Accuracies	213
Appendix E:	Sensor Specifications & Circuit Resistance.....	217
	VarFlex® Sensor Specifications	217
	Hot Wire Flow Sensor Specifications	218
	Circuit Resistance Test.....	219
	Volumetric Capnography Specifications	220
Appendix F:	AVEA Message Bar Text	221
Appendix G:	Advanced Pulmonary Mechanics Monitored Parameters	223
Appendix H:	Capnometry Troubleshooting.....	231
Appendix I:	Volumetric CO₂ Calculations	233
Appendix J:	Electromagnetic Declarations	237
Appendix K:	Glossary	241

Notices

EMC Notice

This equipment generates, uses, and can radiate radio frequency (RF) energy. If this equipment is not installed and used in accordance with the instructions in this manual, electromagnetic interference may result.

This equipment has been tested and found to comply with the limits of acceptance set forth in Standard EN 60601-1-2 for Medical Products. These limits provide reasonable protection against electromagnetic interference (EMC) when operated in the intended use environments described in this manual.

This ventilator is also designed and manufactured to comply with the safety requirements of Standard EN 60601-1, IEC 60601-2-12, CAN/CSA-C22.2 No. 601.1-M90, and UL 2601-1.

This ventilator can be affected by portable and mobile RF communications equipment.

This ventilator should not be stacked with other equipment.

The following cables were used in the evaluation of this ventilator.

- 15619 – Normally Open Patient Call Cable (Length – 1.7 meters)
- 15620 – Normally Closed Patient Call Cable (Length – 1.7 meters)
- 70600 – Cable, Communications (Length – 1 meter)
- 70693 – Cable, Communications (Length – 3 meters)
- Standard Centronics Printer Cable (Length – 2 meters)
- Standard SVGA Monitor Cable (Length – 2 meters)

Use of other cables may result in increased emissions or decreased immunity.

See Tables 201, 202, 203, and 205 for further information regarding the AVEA Ventilator and EMC.

MRI Notice

This equipment contains electromagnetic components whose operation can be affected by intense electromagnetic fields.

Do not operate the ventilator in a MRI environment or in the vicinity of high-frequency surgical diathermy equipment, defibrillators, or short-wave therapy equipment. Electromagnetic interference could disrupt the operation of the ventilator.

Intended Use Notice

The AVEA is intended to provide continuous respiratory support in an institutional health care environment (e.g. hospitals). It may be used on neonatal through adult patients. It should only be operated by properly trained clinical personnel, under the direction of a physician.

Regulatory Notice

Federal law restricts the sale of this device except by or on order of a physician.

The benefit of treatment with medical respiratory support devices outweighs the remote possibility of exposure to phthalates.

Classification

Type of Equipment: Medical Equipment, Class 1 type B
Adult/Pediatric/Infant Lung Ventilator

Declaration of Conformity Notice

This medical equipment complies with the Medical Device Directive, 93/42/EEC, and the following Technical Standards, to which Conformity is declared:

BS EN 60601-2-12:2006

EN 60601-1

EN 60601-1-2

ISO 13485

UL 60601-1

CAN / CSA C22.2 No. 601.1.12-94 (R99)

EU Notified Body:

BSI (Reg. No. 0086)

Trade names:

AVEA ventilator systems

Manufactured by:

CareFusion
22745 Savi Ranch Parkway
Yorba Linda, California 92887-4668
USA



If you have a question regarding the Declaration of Conformity for this product, please contact CareFusion at one of the numbers given in Appendix A.

Safety Information

Please review the following safety information prior to operating the ventilator. Attempting to operate the ventilator without fully understanding its features and functions may result in unsafe operating conditions.

Warnings and Cautions, which are general to the use of the ventilator under all circumstances, are included in this section. Some Warnings and Cautions are also inserted within the manual where they are most meaningful.

Notes are also located throughout the manual to provide additional information related to specific features.

If you have a question regarding the installation, set up, operation, or maintenance of the ventilator, contact Customer Care, as shown in Appendix A Contact & Ordering Information.

Terms

WARNINGS	identify conditions or practices that could result in serious adverse reactions or potential safety hazards.
CAUTIONS	identify conditions or practices that could result in damage to the ventilator or other equipment.
NOTES	identify supplemental information to help you better understand how the ventilator works.

Warnings

Warnings and Cautions appear throughout this manual where they are relevant. The Warnings and Cautions listed here apply generally any time you operate the ventilator.

- The AVEA Ventilator is intended for use by a trained practitioner, under the direction of a qualified physician.
- When the ventilator is connected to a patient, a trained health care professional should be in attendance at all times to react to an alarm or other indications of a problem.
- Alarm loudness must be set above ambient sound in order to be heard.
- Always have an alternate means of ventilation available whenever the ventilator is in use.
- The operator should not touch the electrical connectors of the ventilator or accessories, and the patient simultaneously.
- Due to possible explosion hazard, the ventilator should not be used in the presence of flammable anesthetics.
- An audible alarm indicates an anomalous condition and should never go unheeded.
- Anti-static or electrically conductive hoses or tubing should not be used within the patient circuit.
- If a mechanical or electrical problem is recognized while operating the ventilator, the ventilator must be removed from use and referred to qualified personnel for servicing. Using an inoperative ventilator may result in patient injury.
- When a low gas supply alarm occurs, the oxygen concentration delivered to the patient will differ from that set on the O₂ control setting.
- A source gas failure will change the FiO₂ and may result in patient injury.
- The functioning of this equipment may be adversely affected by the operation of other equipment nearby, such as high frequency surgical (diathermy) equipment, defibrillators, short-wave therapy equipment, “walkie-talkies,” or cellular phones.
- Water in the air supply can cause malfunction of this equipment.
- Do not block or restrict the Oxygen bleed port located on the instrument back panel. Equipment malfunction may result.

- Electric shock hazard - Do not remove any of the ventilator covers or panels. Refer *all* servicing to an authorized CareFusion service technician.
- A protective ground connection by way of the grounding conductor in the power cord is essential for safe operation. Upon loss of protective ground, all conductive parts including knobs and controls that may appear to be insulated can render an electric shock. To avoid electrical shock, plug the power cord into a properly wired receptacle, use only the power cord supplied with the ventilator, and make sure the power cord is in good condition.
- The AVEA is designed to ensure that the user and patient are not exposed to excessive leakage current per applicable standards (UL2601 and IEC60601-1). However, this cannot be guaranteed when external devices are attached to the ventilator. In order to prevent the risk of excessive enclosure leakage current from external equipment attached to the RS-232, printer and video ports, isolation of the protective earth paths must be provided to ensure proper connection. This isolation should ensure that the cable shields are isolated at the peripheral end of the cable.
- Routine assessment of oxygenation and ventilation should be performed when a patient is receiving respiratory support.
- Delivered and monitored flow as well as pressure and volume settings and values are subject to device accuracy specifications as described herein.

Cautions

The following cautions apply any time you work with the ventilator.











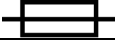

- Ensure that the voltage selection and installed fuses are set to match the voltage of the wall outlet, or damage may result.
- A battery that is fully drained (i.e. void of any charge) may cause damage to the ventilator and should be replaced.
- All accessory equipment that is connected to the ventilator should comply with CSA/IEC601/UL2601.
- To avoid damage to the equipment, clean the air filter regularly.















The following cautions apply when cleaning the ventilator or when sterilizing ventilator accessories.









- Do not sterilize the ventilator. The internal components are not compatible with sterilization techniques.
- Do not gas sterilize or steam autoclave tubing adapters or connectors in place. The tubing will, over time, take the shape of the adapter, causing poor connection and possible leaks.
- DO NOT submerge the ventilator or pour cleaning liquids over or into the ventilator.



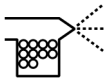

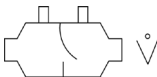
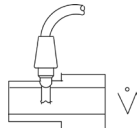

Equipment Symbols

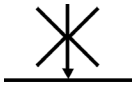
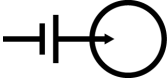
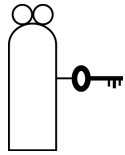
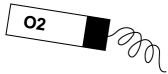
The following symbols may be referenced on the ventilator or in accompanying documentation

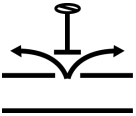
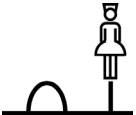
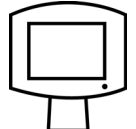
Symbol	Source/Compliance	Meaning
	Symbol #03-02 IEC 60878	Indicates ATTENTION, consult ACCOMPANYING DOCUMENTS
	Symbol #5016 IEC 60417	This symbol indicates a FUSE.
	Symbol #5034 IEC 60417 Symbol #01-36 IEC 60878	This symbol indicates INPUT.
	Symbol #5035 IEC 60417 Symbol #01-37 IEC 60878	This symbol indicates OUTPUT
	Symbol #5031 IEC 60417	This symbol indicates DIRECT CURRENT (DC)
	Symbol #5019 IEC 60417 Symbol #01-20 IEC 60878	This symbol indicates protective EARTH (ground).
	Symbol #5021 IEC 60417 Symbol # 01-24 IEC 60878	This symbol indicates the EQUIPOTENTIAL connection used to connect various parts of the equipment or of a system to the same potential, not necessarily being the earth (ground) potential (e.g., for local bonding).
	Symbol # 5333 IEC 60417 Symbol #02-03 IEC 60878	This symbol indicates TYPE B equipment, which indicates equipment that provides a particular degree of protection against electric shock, particularly with regards to allowable leakage current and reliability of the protective earth connection.
	Symbol #5032 IEC 60417 Symbol #01-14 IEC 30878	This symbol is located on the rating plate. It indicates the equipment is suitable for alternating current.
	Symbol #5007 IEC 60417 Symbol #01-01 IEC 60878	Indicates ON (Power)
	Symbol #5008 IEC 60417 Symbol #01-02 IEC 60878	Indicates OFF (Power)
	Symbol #0651 ISO 7000	Horizontal return with line feed. Indicates ACCEPT entered values for a specific field.
	CareFusion Symbol	Indicates PATIENT EFFORT
	CareFusion Respiratory Care symbol	Indicates MANUAL BREATH

	CareFusion Symbol	MAIN SCREEN
	Symbol #417 IEC 5102	EVENT READY
	CareFusion Symbol	MODE
	CareFusion Symbol	ADVANCED SETTINGS
	CareFusion Symbol	SET-UP for patient size selection
	MDD Directive 93/42/EEC	CE Mark
	Symbol #5307 IEC 60417	ALARM RESET
	Symbol #5319 IEC 60417	ALARM SILENCE
	CareFusion symbol	ADULT patient
	CareFusion symbol	PEDIATRIC patient
	CareFusion symbol	NEONATAL (Infant) patient
 CANCEL	Graphical Symbol in general use internationally for "DO NOT"	CANCEL, i.e. do not accept entered values.
	CareFusion symbol	Select DISPLAYED SCREEN function.
	Symbol 5467 IEC 60417	FREEZE the current display.

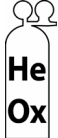
	CareFusion symbol	Enable the ALARM LIMITS screen
	CareFusion symbol	This symbol indicates a CONTROL LOCK.
	CareFusion symbol	NEBULIZER port
	CareFusion symbol	Increase OXYGEN
	CareFusion symbol	PRINT SCREEN
	CareFusion symbol	SUCTION port
	CareFusion symbol	VARIABLE ORIFICE FLOW SENSOR connection
	CareFusion symbol	HOT WIRE FLOW SENSOR connection
	CareFusion symbol	ANALOG IN/OUT connection
	CareFusion symbol	Display the MAIN SCREEN
	CareFusion symbol	DO NOT BLOCK PORT
	CareFusion symbol	EXTERNAL BATTERY connection
	CareFusion symbol	Indicates GAS ID port
	CareFusion symbol	OXYGEN SENSOR connection

	<p>CareFusion symbol</p>	<p>OVERPRESSURE relief</p>
	<p>CareFusion symbol</p>	<p>REMOTE NURSE CALL connection</p>
	<p>CareFusion symbol</p>	<p>USER INTERFACE MONITOR connection</p>
	<p>CareFusion symbol</p>	<p>This symbol indicates an INTERNAL BATTERY FUSE</p>
	<p>CareFusion symbol</p>	<p>This symbol indicates ALARM LOUDNESS</p>
	<p>CareFusion symbol</p>	<p>This symbol indicates that the AVEA is being powered by the INTERNAL BATTERY only.</p>
	<p>CareFusion symbol</p>	<p>This symbol indicates that the HELIOX configuration is in use.</p>
	<p>CareFusion symbol</p>	<p>This symbol indicates the product contains phthalates.</p>

Chapter 1: Introduction

The AVEA is a fourth generation, servo-controlled, software-driven ventilator. It has a dynamic range of breathing gas delivery that provides for neonatal through adult patients. Its revolutionary user interface module (UIM) provides maximum flexibility with simple operator interaction. It has a flat panel color LCD with real time graphic displays and digital monitoring capabilities, a touch screen for easy interaction, membrane keys and a dial for changing settings and operating parameters. A precision gas delivery engine with servo controlled active inhalation and exhalation improves performance over previous generations.

The AVEA has been designed to function using most commonly available accessories. It is easy to clean and its design does not allow liquids to pool on the casing, reducing the likelihood of fluid leakage into the body of the ventilator.

There are two models of AVEA: Comprehensive and Standard. The following table shows the standard and optional functions available with each model.

Functions & Accessories	Standard	Comprehensive
Modes	All	All
Proximal Hot Wire Flow Sensing	☒	☒
Synchronized Nebulizer	☒	☒
24 Hour Trending	☒	☒
Internal Battery	☒	☒
Full Color Graphics Display	☒	☒
Loops and Waveforms	☒	☒
Standard Cart	☒	
Proximal Variable Orifice flow sensing		☒
Proximal Airway Pressure Monitoring		☒
Tracheal Catheter		☒
Esophageal Balloon		☒
Internal Compressor		☒
Heliox Delivery		☒

Optional Functions & Accessories	Standard	Comprehensive
Custom Cart	Option	Included
External Battery (on custom cart only)	Option	Option
Gas Tank Holder (on either cart)	Option	Option
Internal Compressor	Option	Included
Pflex Maneuver	Option	Included
Heliox Delivery	Option	Included
nCPAP	Option	Included
VCO ₂	Option	Option

Some AVEA Features

Artificial Airway Compensation¹

When Artificial Airway Compensation is turned on, the ventilator automatically calculates the pressure drop across the endotracheal tube. The AVEA then adjusts the airway pressure to deliver the set inspiratory pressure to the distal (carina) end of the endotracheal tube. This calculation takes into account flow, gas composition (Heliox or Nitrogen/Oxygen), Fraction of Inspired Oxygen (FIO₂), tube diameter, length, and pharyngeal curvature based on patient size (Neonatal, Pediatric, Adult). This compensation only occurs during inspiration. Artificial Airway Compensation is active in all Pressure Support and Flow Cycled Pressure Control Breaths.

WARNING!

Activating of Artificial Airway Compensation while ventilating a patient will cause a sudden increase in the peak airway pressures and a resultant increase in tidal volume. If you choose to activate Artificial Airway Compensation while the patient is attached to the ventilator you will need to exercise caution to minimize the risk of excessive tidal volume delivery.

Note:

Monitored airway pressures (inspiratory) will be higher than set values when Artificial Airway Compensation is active.

With an inspiratory pressure setting of zero, Artificial Airway Compensation will still provide an elevated airway pressure, which will compensate for the resistance of the endotracheal tube.

When turned on the Artificial Airway Compensation indicator will appear in all modes of ventilation even though the function may not be active (i.e.: Volume Controlled Breaths). This is to alert you to the fact that Artificial Airway Compensation will become active if a Pressure Support or combination mode (e.g. Volume Control SIMV) is selected.

Range: Off/On

Default: Off

Available in all patient sizes

¹ Estimation of Inspiratory Pressure Drop in Neonatal and Pediatric Endotracheal Tubes, by Perre-Henri Jarreau, American Physiological Society 1999

Full range of Patient Size

You can select a patient size of Adult, Pediatric, or Neonate. Once the selection is made, the ventilator offers only those parameters, which are available for your selected patient size.

Non-Invasive Ventilation

The ventilator can perform non-invasive ventilation with a standard dual limb circuit. Leak compensation should be turned on when using this feature. To turn leak compensation on, use the touch screen control displayed in the Ventilator Set-Up Screen.

Note:

Non invasive ventilation requires the use of a snug fitting mask with no bleed holes. Excessive leaks around the mask may result in false triggering of the ventilator or assertion of disconnect alarms.

Leak Compensation

Leak Compensation is used to compensate for baseline leaks, which may occur at the patient mask interface or around the patient's endotracheal tube. It only provides baseline leak compensation and is not active during breath delivery.

During exhalation, PEEP is maintained by the cooperation of the Flow Control Valve (FCV) and the Exhalation Valve (ExV). The ExV pressure servo is set to a target pressure of PEEP and the FCV pressure servo is set to a pressure target of PEEP - 0.4 cmH₂O. The ExV servo relieves when the pressure is above its target and the FCV supplies flow when the pressure drops below its target up to a maximum flow rate for the patient size

Range: Off/On

Default: Off

Circuit Compliance Compensation

When Circuit Compliance is active, the volume of gas delivered during a volume controlled or targeted breath is increased to include the set volume, plus the volume lost due to the compliance effect of the circuit. Circuit Compliance is active for the set Tidal Volume during volume control ventilation, the Target Tidal Volume in PRVC mode and for Machine Volume. It is only active in Adult and Pediatric applications.

Exhaled volume monitors for all modes and breath types are also adjusted for the compliance compensation volume.

Range: 0.0 to 7.5 ml/cmH₂O

Default: 0.0 ml/cmH₂O

The ventilator automatically measures Circuit Compliance during the Extended Systems Test (EST). The value cannot be entered manually.

Note:

Although circuit compliance is displayed on the Setup screen **it is not active for neonatal patients.**

High circuit compliance with small tidal volumes may result in extended inspiratory times. This is a result of the delivery of the circuit compliance volume at the set flow rate.

Setting extremely small delivered tidal volumes with Circuit Compliance Compensation not active and using a proximal flow sensor may result in assertion of Patient Circuit Disconnect Alarms.

Humidification

You can select active or passive humidification (ON/active or OFF/passive). Active humidification assumes 99% RH; passive assumes 60% RH when using an HME. This feature adjusts the BTPS correction factor to correct exhaled tidal volumes.

Range: Off/On
Default: Active (ON)

Note:

Incorrect setting of the Humidification feature will affect monitored exhaled volume accuracy.

Heliox Delivery (Comprehensive only, option on Standard)

Using patented “Smart” connector technology, the Comprehensive model AVEA can deliver Heliox blended gas instead of Medical air. By simply changing a connector on the back panel, the ventilator identifies the gas input and adjusts to accommodate the change. All volumes (numeric and graphic) are automatically compensated for accurate display.

The clinical benefits of helium / oxygen gas are based on its significantly lower gas density when compared to nitrogen / oxygen gas. This lower gas density allows the same volumetric (tidal volume) of gas to be delivered to the patient at a significantly lower airway pressure. Additionally, the low-density properties of the gas allow it to diffuse past airway obstructions or restrictions much easier than nitrogen / oxygen gas mixtures.

Note:

The Heliox “smart” connector is designed for use with an 80/20 Heliox tank only. Only a mixture of 20% oxygen and 80% Helium can be used as the Heliox gas supply.



If Heliox gas is connected this green icon displays in bottom right of the touch screen.

To set the Helium / Oxygen mixture during administration simply set the desired FiO_2 , the balance of the breathing gas is Helium.

For example:

A set FiO_2 of 35% will deliver a 65/35 Heliox mixture to the patient.

WARNING

Connection of a gas supply at the Helium-Oxygen mixture inlet that does not contain 20% oxygen can cause hypoxia or death.

Although an 80/20 mixture of Helium and Oxygen is marketed as medical gas, the Helium/Oxygen gas mixture is not labeled for any specific medical use.

Note:

Hot wire flow sensors will not function with Heliox gas mixtures. During Heliox delivery, a variable orifice flow sensor should be used for monitoring delivered volumes at the proximal airway.

Note:

Heated humidifier performance should be carefully monitored during Heliox therapy. Helium has significantly greater thermal conductivity compared to nitrogen / oxygen gas mixtures and this could cause difficulty with some heated humidification devices. A febrile patient may transfer heat via the gas column to a proximal temperature sensor, which could affect the duty cycle of the humidifier and decrease output. This could cause desiccation of secretions in the airway.

Alternately, in applications where a heated wire breathing circuit is used, this heat transfer from the patient may affect the duty cycle of the heated wire circuit, which may result in **increased** condensation in the breathing circuit.

The relative settings of some types of humidifiers may need to be reduced to prevent overheating of the breathing gas.

Note:

The Oxygen alarm cannot be disabled during Heliox administration
Do not operate nebulizer while using heliox

This page intentionally left blank.

Chapter 2: Unpacking and Setup

Ventilator Assembly & Physical Setup

Unpacking the Ventilator

The AVEA is designed for simplicity of operation and set-up. It requires minimal assembly on site.

Items Required for Ventilator Setup

You will need the following to setup your AVEA ventilator:

- **Power Source.** The ventilator operates from a standard 100, 110, 220, or 240 VAC power source or an optional external 24VDC battery. There is an internal battery supplied with the ventilator, which will operate the ventilator for short periods (see “Chapter 8: Maintenance and Cleaning”).

CAUTION

The ventilator should be connected to a mains AC power supply for **at least 4 hours** prior to switching to internal battery power. For operation on external battery the ventilator should be connected to a mains AC power supply for at least 12 hours with green LED lit to insure a fully charged battery.

- **Pressurized Oxygen, Air or Heliox Gases.** The compressed gas sources *must* provide clean, dry, medical grade gas at a line pressure of 20 to 80 PSIG (1.4 to 5.6 bar).

Air or Heliox Supply

Pressure Range:	20 to 80 psig (1.4 to 5.5 bar) (Supply Air)
	20 to 80 psig (1.4 to 5.5 bar) (Supply Heliox - 80% / 20% Heliox Only)
	3 to 10 psig (0.2 to 0.7 bar) (Compressor Air)
Temperature:	5 to 40°C (41 to 104°F)
Minimum Flow:	80 L/min at 20 psig (1.4 bar)
Air Inlet fitting	CGA DISS-type body, No. 1160 (Air). NIST fitting per BS-5682:1984 (Air) also available.
Heliox Inlet fitting	CGA DISS-type body, No. 1180 (Heliox)

Note:

NIST fittings for air and oxygen are available from CareFusion upon request at the time of the order.

Oxygen Supply

Pressure Range:	20 to 80 psig (1.4 to 5.5 bar) (Supply Oxygen)
Temperature:	5 to 40° C (41 to 104° F)
Humidity:	Dew Point of gas should be 1.7° C (3° F) below the ambient temperature (minimum)
Minimum Flow:	80 L/min at 20 psig (1.4 bar)
Inlet Fitting:	CGA DISS-type body, No. 1240. NIST fitting per BS-5682:1984 (O ₂) also available.

Assembling the Ventilator

Assemble your AVEA ventilator's wheeled base using the instructions included in the package. The ventilator body is easily attached to the base by means of four thumbscrews. Reference the AVEA Service Manual Installation Instructions for detailed directions (Figure 2-1).

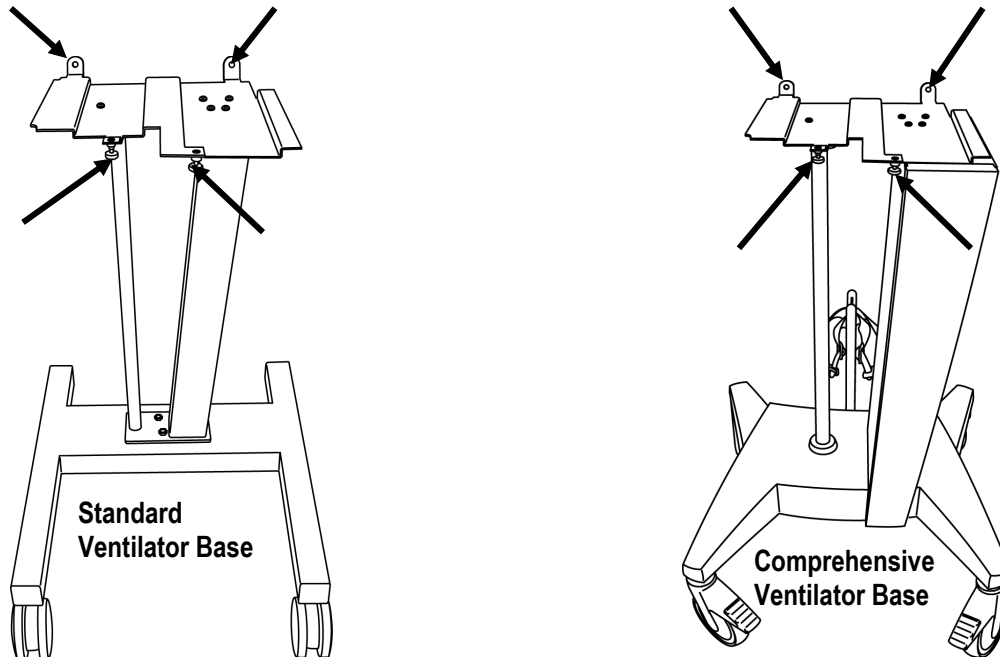

Figure 2-1: Basic and Comprehensive base attachment

CAUTION

The ventilator body and UIM weigh approximately 80 lbs. (36.4 kg) Employ safe lifting procedures when assembling the ventilator.

External battery option

If you have purchased the optional external battery pack, reference AVEA Service Manual, Installation Instructions. Install your external batteries per the installation instructions enclosed with the cart accessories kit (P/N 11372).

Setting Up the Front of the Ventilator

Assembling the Exhalation Filter and Water Trap

To assemble and insert the exhalation filter and water trap do the following:

Screw the supplied water collection bottle into the threaded cuff of the water trap.

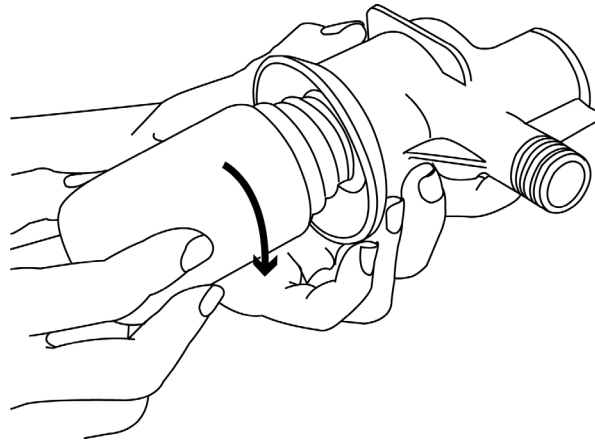
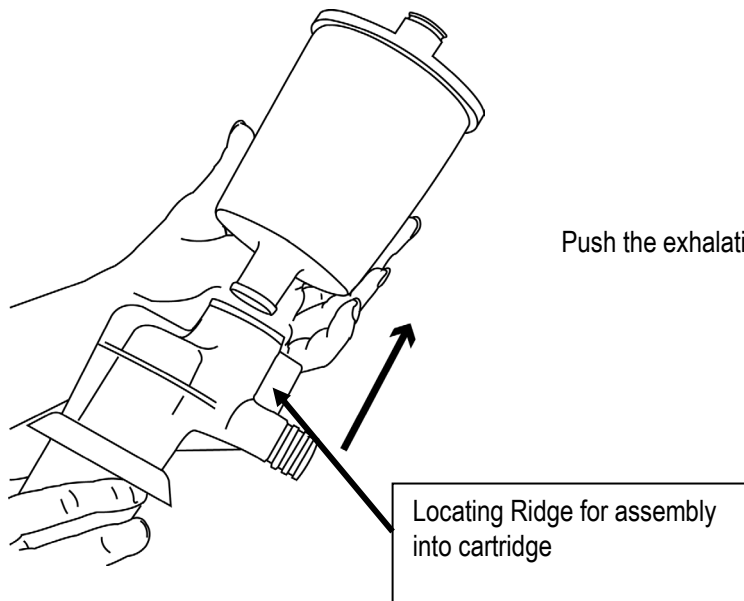

Figure 2–2: Attaching the Collection Bottle to the Water Trap



Push the exhalation filter into the water trap assembly top as shown.

Figure 2–3: Attaching the Exhalation Filter

Align the locating ridge on the water trap assembly with the slot in the exhalation filter cartridge (Figure 2-4).

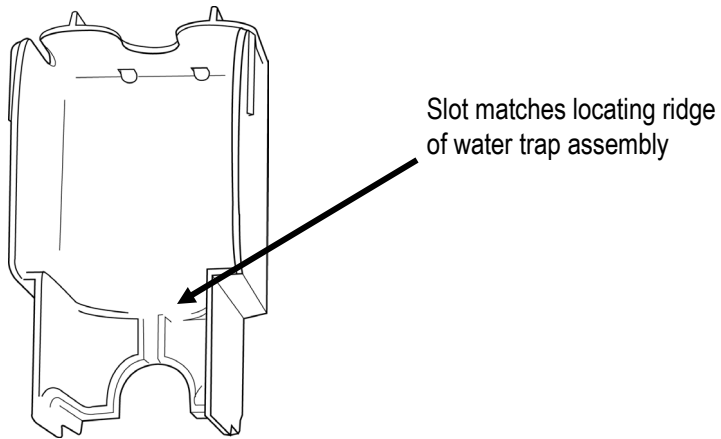

Figure 2-4: Exhalation Filter Cartridge Showing Locating Slot

Slide the water trap/exhalation filter assembly into the cartridge (Figure 2-5).

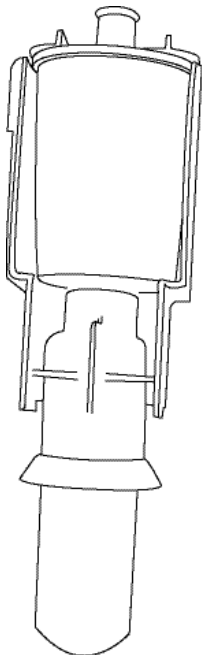
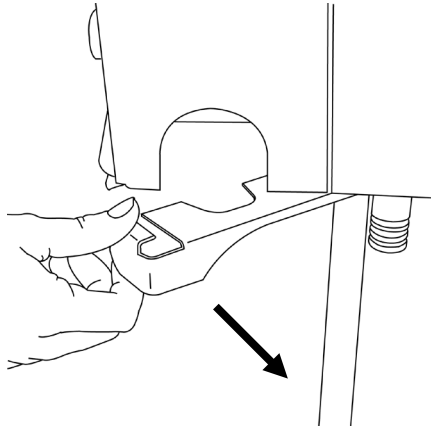

Figure 2-5: Exhalation Filter/Water Trap Assembly in Cartridge



Rotate the metal locking lever on the lower right of the ventilator body forward to an open position.

Figure 2-6: Open locking lever

Insert the completed cartridge assembly into the ventilator body as shown. Make sure it is completely seated in the well.

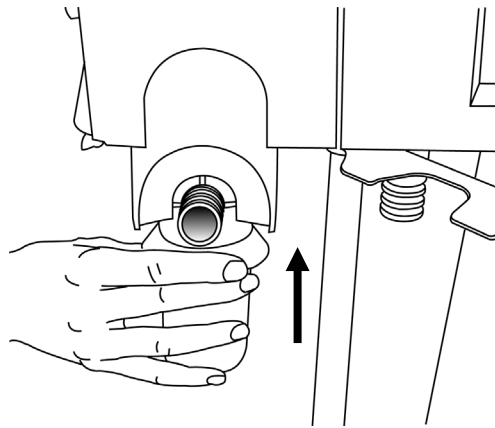
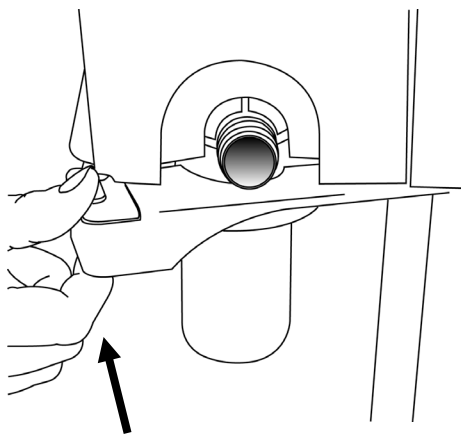

Figure 2-7: Insert exhalation filter

Note:

Placement of the exhalation filter/water trap assembly without the exhalation filter cartridge may cause misalignment of the filter seal resulting in patient breathing circuit leaks.



Close the locking lever.

Figure 2-8: Close locking lever in place

AVEA® Disposable Expiratory Filter / Water Trap

User Instructions

Installation

Note:

The AVEA Disposable Expiratory Filter / Water Trap is supplied non-sterile. It can be used as an alternative for the AVEA reusable filter assembly (reusable filter, a collector vial, a water trap, and a cartridge component). The AVEA reusable filter assembly is **not** required when using the Disposable Expiratory Filter / Water Trap.

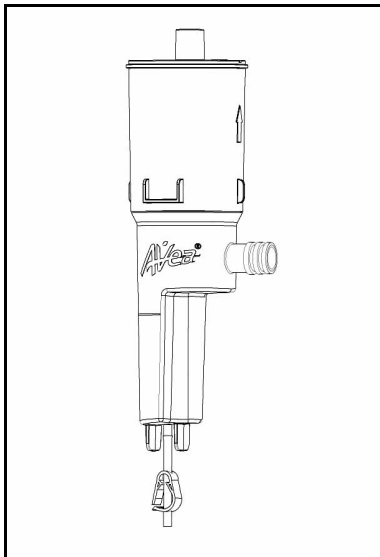

Figure 2-9: AVEA Disposable Expiratory Filter / Water Trap

1. Locate the metal locking lever on the front lower left side of the ventilator, then rotate the lever outwards to a fully open position.

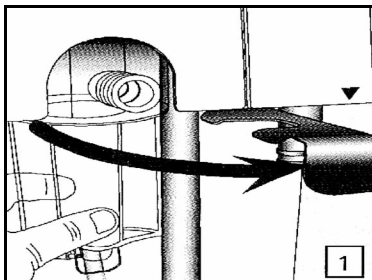

Figure 2-10: Inserting the Filter / Water Trap combination

2. Insert the AVEA Disposable Expiratory Filter into the filter cavity with the orientation as shown in Figure 2-10. Make sure the filter is fully inserted into the filter cavity before closing the lever.

3. Close the locking lever completely to secure the filter in the ventilator well.

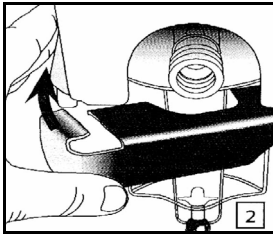

Figure 2-11: Closing the locking lever

After you close the locking lever, the filter is ready for use.

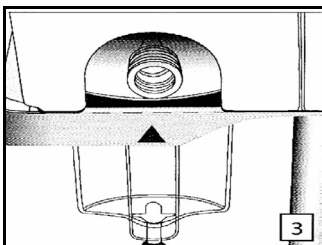

Figure 2-12: Completed installation of Filter / Water Trap combination

WARNING

Incomplete insertion of the AVEA Disposable Expiratory Filter may cause misalignment of the filter seal, which will result in patient circuit leakage.

Note:

The lever closes without great difficulty if the filter is fully inserted into the filter cavity.

WARNING

The locking lever must be closed completely to ensure that the filter is properly installed and securely locked.

4. Drain Tube and Pinch Clamp. Inspect for any visible damage and make sure it is securely installed.
5. Periodically inspect the filter-vial water level and empty it before it reaches the maximum-level line.
6. To empty the fluid in the collection vial, press open the pinch clamp to empty contents of the collection vial into an appropriate receptacle. Close and lock the pinch clamp when finished.

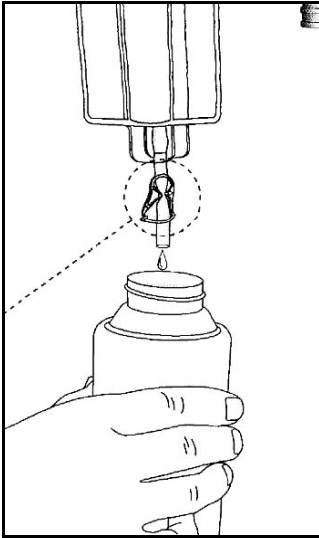

Figure 2–13: Draining water trap

WARNING

The drain tube must be fully attached to the filter and the pinch clamp must be in the closed position.

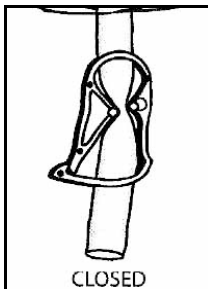

Figure 2–14: Closed pinch clamp

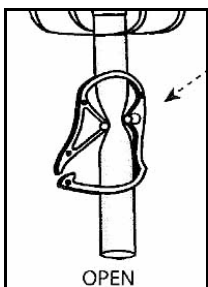

Figure 2–15: Open pinch clamp

CLEANING:

Only the exterior of the filter can be cleaned. This is done by a gentle wipe down using only mild cleaning solutions that are compatible with polystyrene plastic such as Isopropyl Alcohol or Chlorine Compounds. These cleaning solutions are to be diluted by volume in water, with a recommended maximum concentration of 1:10.

CAUTION

Do not attempt to clean the filter media. Do not attempt to sterilize or reuse the filter.

WARNING

To avoid increased filter flow resistance, do not immerse breathing circuit filters in liquid. To avoid a reduction in filtration efficiency, do not attempt to scrub or touch the filter medium located inside the filter.

INSPECTION: Inspect for any visible damage to the plastic housing or the folded filter media before use. Discard if there is any damage.

REPLACEMENT: AVEA Disposable Exhalation Filter, including the drain tube and the pinch clamp are single use items. Replace with a new unused filter at each circuit change.

WARNING

Do not attempt to sterilize or reuse this filter.

Note:

Dispose used filters in accordance with your institution's protocol. Sterilize before nondestructive disposal. Follow local governing ordinances and recycling plans regarding disposal or recycling of medical device components

Additional Information:

Detailed information on the specifications of this assembly can be found in Appendix .B, Specifications

Attaching the Patient Circuit

Adult Circuit using an Active Humidifier

Using an active humidifier, the adult patient circuit is set up as shown in Figure 2–16. Attach your humidifier to the upright pole of the AVEA base. Adjust the height of the humidifier and the length of the humidifier tubing so that the tubing is relatively straight with no occlusions.

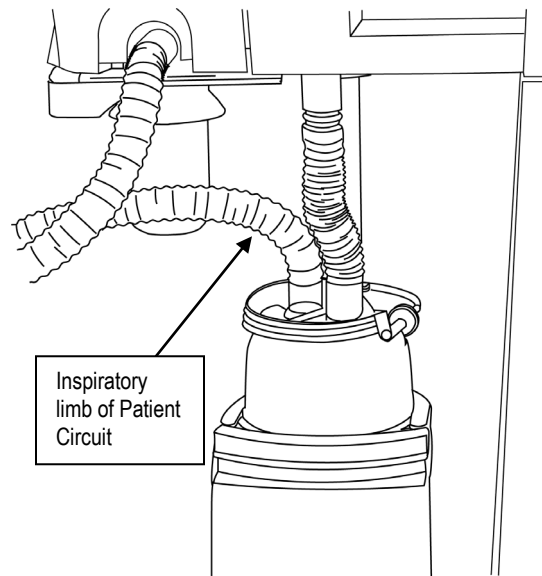
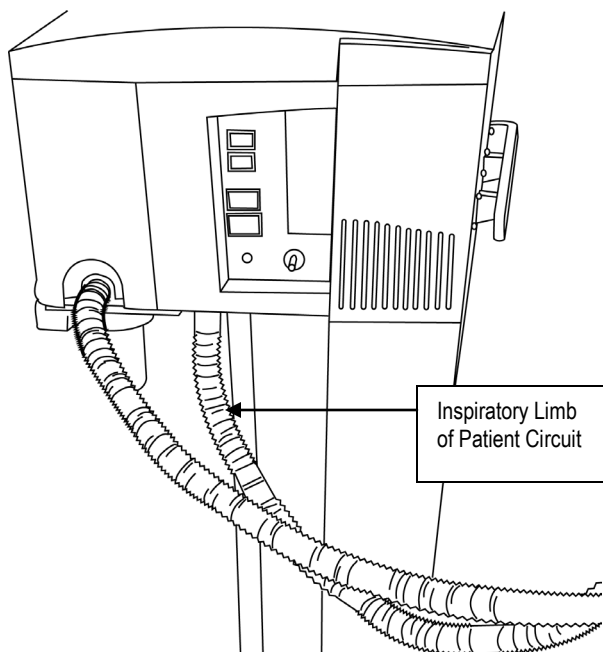

Figure 2–16: Adult Circuit with Active Humidifier

Adult Circuit without active humidifier



The setup for use with a passive humidifier or HME is per Figure 2–17. The inspiratory limb of the patient circuit connects directly to the gas output of the ventilator. The passive humidification system should be placed in-line in the patient circuit per the manufacturer's instructions.

Figure 2–17: Adult Patient Circuit without active humidifier.

Neonatal Patient Circuit

The Neonatal Patient Circuit is attached as shown in Figure 2–18.

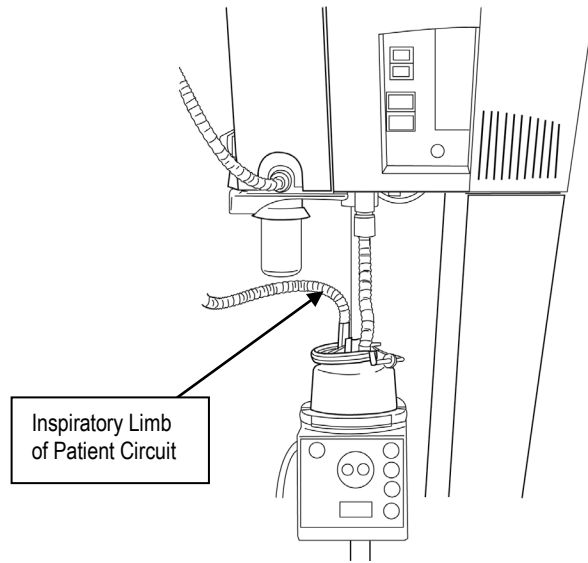

Figure 2–18: Neonatal Patient Circuit

Front Panel Connections

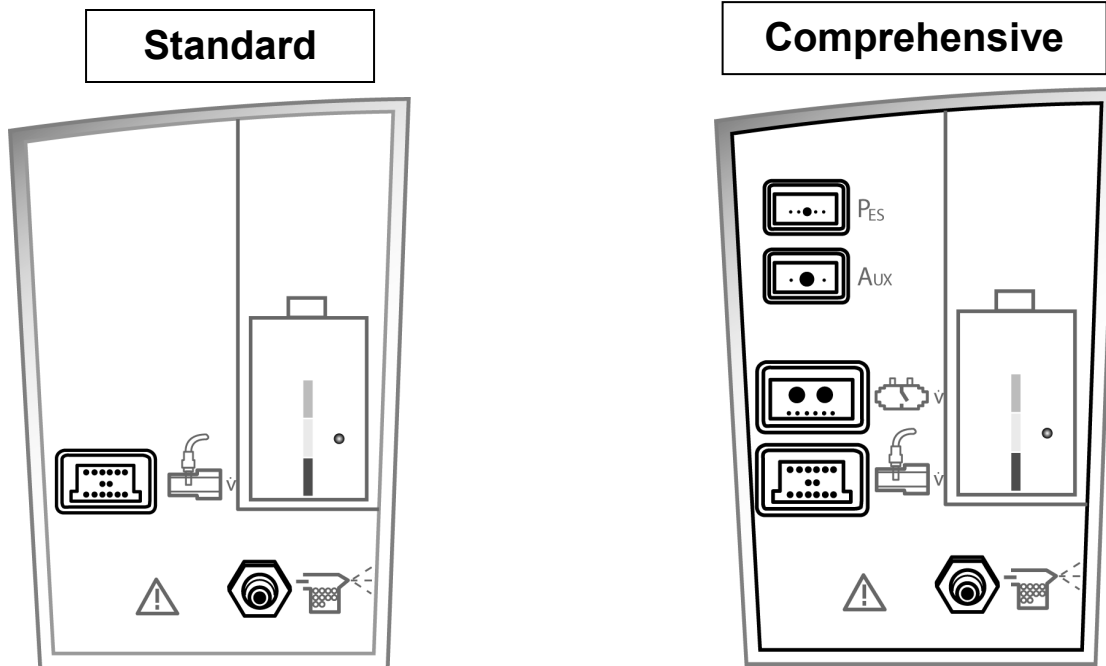

Figure 2–19: AVEA Front Panel Configurations Standard & Comprehensive

Attaching Flow Sensors

The AVEA can accept either a hot wire or a variable orifice proximal flow sensor. These are in addition to the instrument's internal inspiratory flow sensor and heated expiratory flow sensor. Three proximal flow sensors are available for the AVEA.

The standard Hot Wire flow sensor is suitable for neonatal and pediatric applications where the peak inspiratory flow rate is less than 30 L/min. This flow sensor is not active in adult applications.

Hot Wire Flow Sensor

A Hot Wire flow sensor attaches to the receptacle circled in light blue directly below the variable orifice flow sensor connection on the front panel. The receptacle is marked with the icon shown here.

This is a locking connector. To attach, first pull back the locking collar, then push firmly onto the ventilator receptacle.

To disconnect, first retract the plastic collar then firmly pull the connector away from the ventilator. Do not pull up or down as this can damage the connector

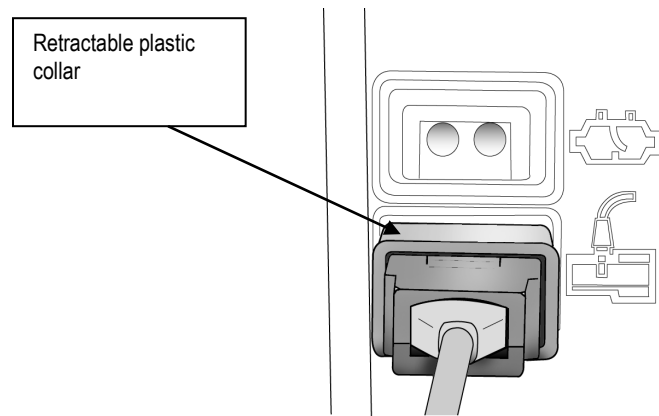

Figure 2–20: Hot wire Flow Sensor Attachment

CAUTION

Flow sensors must be attached at both the patient wye and at the ventilator connection to ensure proper function of the AVEA.

Note:

Hot wire flow sensors will not function with Heliox gas mixtures. During Heliox delivery, a variable orifice flow sensor should be used for monitoring delivered volumes at the proximal airway.

Hot Wire Flow Sensor Zero Procedure

It is recommended that this procedure is done when installing a new hot wire flow sensor and as a possible remedy to a drifting waveform baseline.

The standard hot wire flow sensor is suitable for neonatal and pediatric applications where the peak inspiratory flow rate is less than 30 L/min. This flow sensor is not active in adult applications. The following procedure describes how to reset or re-zero the Hot Wire Sensor offset.

To reset or re-zero the Hot Wire Sensor offset:

1. Select **Utility** from the screens menu.
2. Select the **Monitoring** tab from the Utility screen
3. Press the **Zero Sensor** button under the **Hot Wire Flow Sensor** section.
4. Remove the hot wire flow sensor from the patient circuit.
5. Block both ends of the flow sensor with your gloved fingers so no flow occurs.
6. While holding the sensor steady (without movement), press the **Continue** button.
7. Wait for the Zero Sensor Completed message to appear.
8. Reinstall the hot wire flow sensor into the patient circuit.
9. If the flow sensor continues to drift or read inaccurately, repeat this procedure or replace the flow sensor.

Note:

The above steps must be executed in the proper sequence. If the test is repeated, only the last value measured is saved. The saved value will then be applied to all future measurements of flow and volume that use this flow sensor. This procedure will not “fail” but is limited on the offset amount it can correct for. If the hot wire flow sensor continues to drift or read inaccurately after completing this procedure, the offset value is being limited and the sensor should be cleaned or replaced.

Variable orifice flow sensors are also available on some AVEA models. The neonatal VarFlex flow sensor is compatible in neonatal and pediatric applications where the peak inspiratory flow rate is less than 30L/min and is not active in adult applications. For adult and large pediatric applications a Pediatric / Adult VarFlex flow sensor is available for use with patients whose flow requirements fall within the range of 1.2 – 180 L/min.

Detailed information on the specifications of each flow sensor can be found in Appendix E: Sensor Specifications and Circuit Resistance.

Variable Orifice Flow Sensor

Variable Orifice sensors attach to the receptacle on the front panel of the ventilator circled in dark blue and marked with the icon shown here.

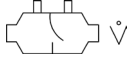

This is a locking connector. To attach, first pull back the plastic locking collar, then push firmly onto the ventilator receptacle. Then push the locking collar forward to lock the flow sensor in place.

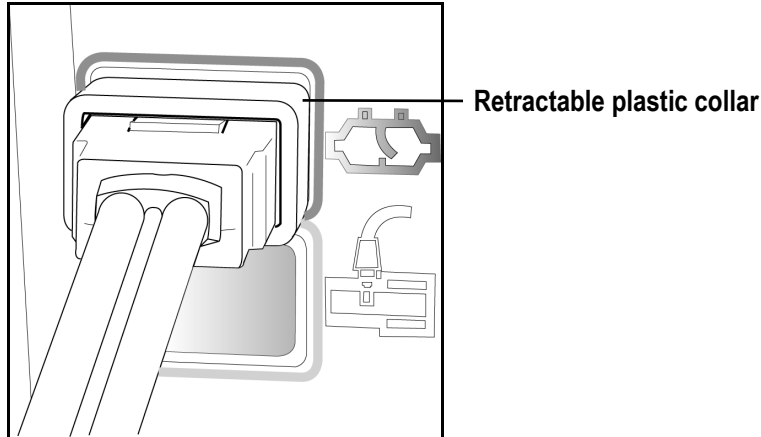

Figure 2–21: Variable Orifice Flow Sensor Attachment

To disconnect, first retract the plastic collar then firmly pull the connector away from the ventilator. Do not pull up or down as this can damage the connector.

CAUTION

Fully retract the plastic locking collar before attaching these connectors. Failure to do this can cause damage to the connector.

Attaching a Nebulizer

You can use an in-line nebulizer with the AVEA ventilator (see “Chapter 3: Ventilator Operation”). The nebulizer is synchronized with inspiration, delivers gas at the set FI_2 and is active for 20 minutes. Attach the nebulizer tubing to the fitting at the bottom of the front panel as shown here. The fitting is marked with the icon shown here.

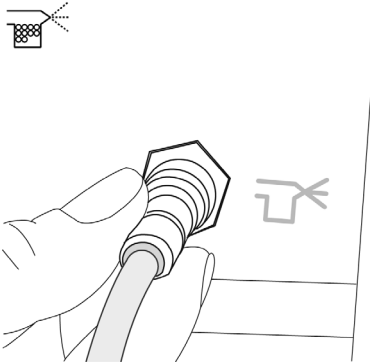

Figure 2–22: Attaching nebulizer tubing

Note:

To use the internal nebulizer, the AVEA must be connected to a high-pressure air source. The nebulizer is not active while the AVEA is operating on its internal compressor. The ventilator incorporates an internal pneumatic compressor, which creates the drive pressure necessary to operate the nebulizer.

Note:

The nebulizer requires an inspiratory flow rate of at least 16 liters-per-minute to activate and is flow compensated to maintain set tidal volumes.

CAUTION

When the internal nebulizer is used, the ventilator decreases the flow rate by 6 L/min to compensate for the nebulizer output. However, since flow from the internal nebulizer can vary, using the internal nebulizer may impact the tidal volumes delivered to the patient.

Note:

Do not operate the nebulizer while using Heliox.

Note:

An optional filter may be attached to the nebulizer port for filtration of the nebulizer gas flow.

Attaching a Proximal Pressure Sensor

A proximal pressure sensor to **monitor** proximal airway pressure can be attached to the Comprehensive model of AVEA. On the Comprehensive AVEA the connector is labeled as Aux as shown in Figure 2–23 and is circled in purple.

When active, this feature will display & alarm to proximal airway pressures.

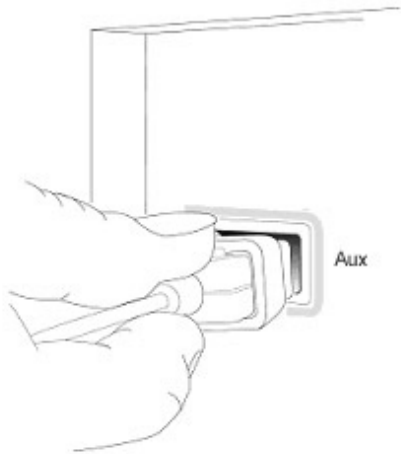

Figure 2–23: Proximal pressure sensor connection on the Comprehensive AVEA

Note:

In applications which generate high resistances within the breathing system monitored, Proximal Airway Pressure may be higher than set Inspiratory Pressure.

(Comprehensive Model Only)

Esophageal Balloon

The connection intended for an esophageal balloon is circled in green at the top of the front panel as shown here. It is identified with the legend P_{ES}.

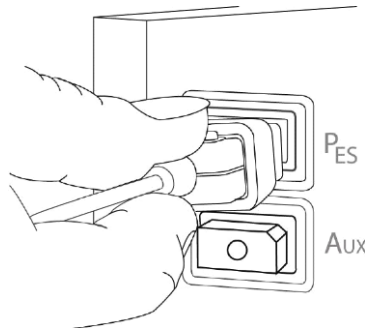

Figure 2–24: Esophageal balloon connector

Note:

See “Chapter 4: Monitors, Displays and Maneuvers” for placement technique for esophageal balloons.

Tracheal Catheter

A tracheal catheter will attach to the AVEA at the connection on the front panel marked as Aux. The connector is shown in Figure 2–23.

Note:

See “Chapter 4: Monitors, Displays and Maneuvers” for placement technique for tracheal catheters.

WARNING

The AVEA is designed to ensure that the user and patient are not exposed to excessive leakage current per applicable standards (UL2601 and IEC60601-1). However, this cannot be guaranteed when external devices are attached to the ventilator.

To prevent the risk of excessive enclosure leakage current from external equipment attached to the RS-232, printer or video ports, the protective earth paths must be isolated to ensure proper connection.

This isolation should ensure that the cable shields are isolated at the peripheral end of the cable.

See “Appendix B: Specifications” regarding connections and communications.

Setting Up the Rear of the Ventilator

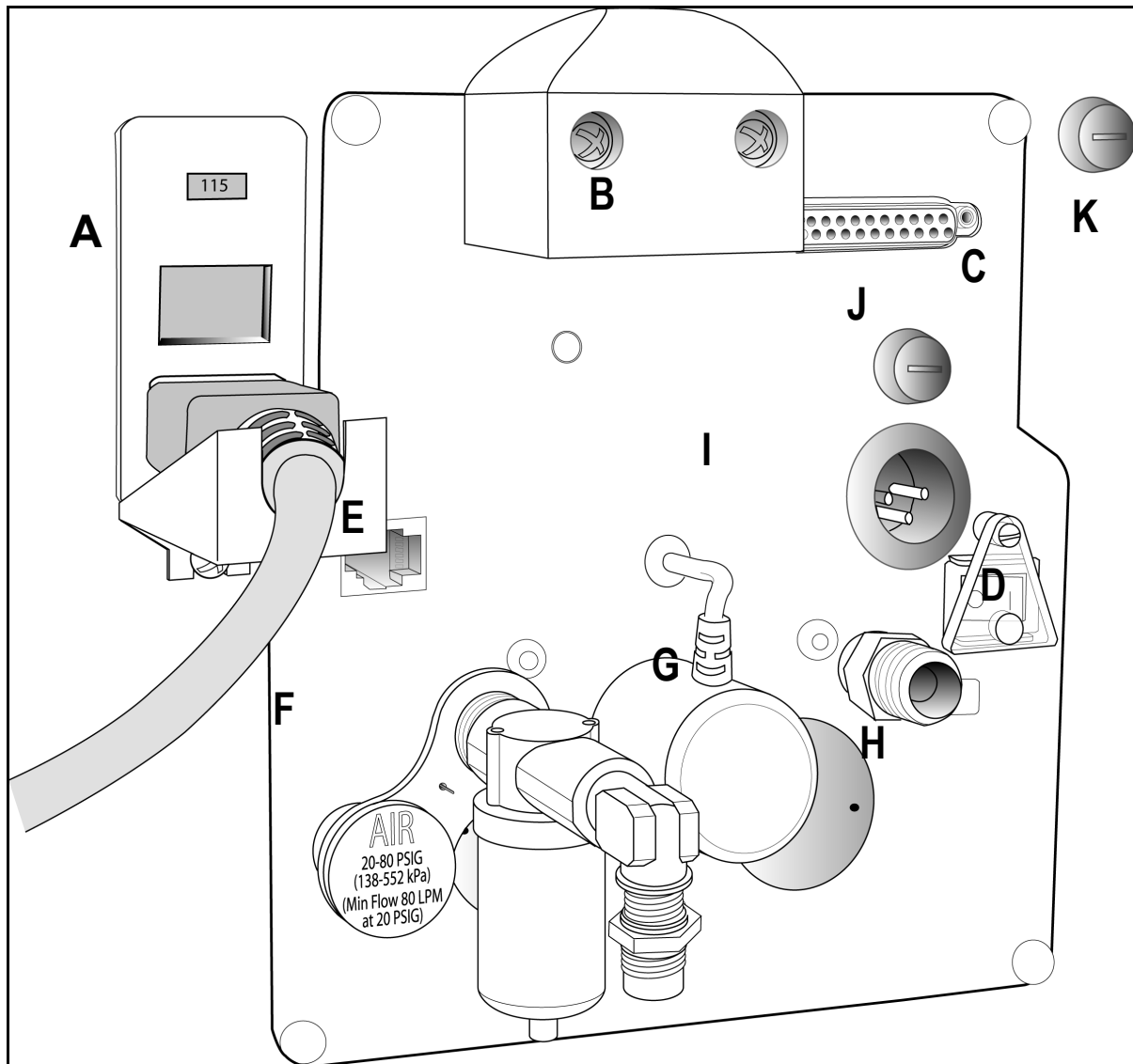
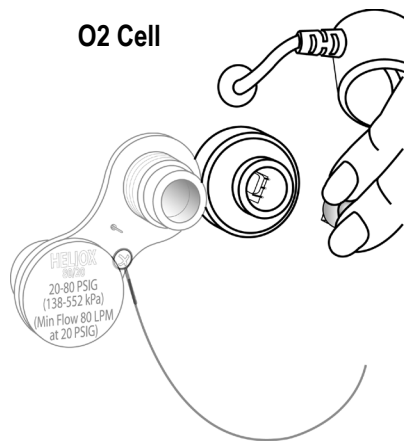

Figure 2–25: Rear panel

A	AC power module	H	Oxygen hose connection
B	UIM connection	I	External battery connector
C	Analog input/output/ILV	J	External battery fuse
D	Power ON/OFF Switch	K	Internal battery fuse
E	Nurse call system connection		
F	Air/Heliox smart connector		
G	Oxygen sensor		

Connecting the Oxygen Sensor



The oxygen sensor cell is located on the rear panel, between the two gas fittings. The oxygen sensor cable emerges from the rear panel directly above the sensor. Carefully align and then gently push the connector onto the oxygen sensor until it seats. When a good connection has been made, slide the protective cover down and push over the sensor.

Figure 2–26: Connecting the O2 Sensor

Connecting Gas Fittings

The “Smart” Air Fitting

There are two gas connections on the rear panel of the ventilator. The one on the left of the panel is for attaching the Air or Heliox gas source.

The smart connector fitting type shown here is CGA DISS-type body No. 1160 for air with an integral water trap/filter. To prevent the entry of moisture into the ventilator from a wall air source, the external water trap is placed in-line between the air hose and the “smart” air connector.

To attach, align the connector assembly (Figure 2–27), seat gently onto the fitting and screw down the fitting collar until finger tight.

Similar connectors for Air with NIST and Air Liquide fittings are also available from CareFusion.

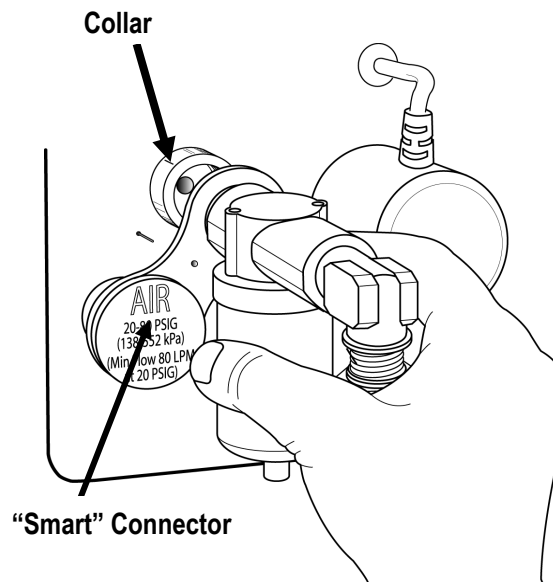

Figure 2–27: Attaching the Air “smart” connector with water trap.

The “Smart” Heliox Fitting

A DISS-type, No. 1180 smart connector fitting is also available for use with an 80/20 Heliox gas mixture (Figure 2–28). Follow the instructions contained with your Heliox kit to install the tethered Heliox connector. This fitting has no integral water trap/filter. All AVEA “Smart” connectors with or without the integral water trap/filter, attach in the same way. Align the connector (Figure 2–27 and Figure 2–28), seat gently onto the fitting and screw down the fitting collar until finger tight.

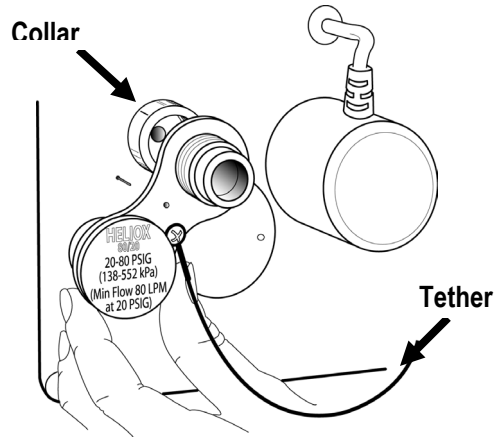

Figure 2–28: Attaching the Tethered Heliox Connector

The AVEA “Smart” connectors signal to the ventilator which type of fitting is attached and therefore which gas controls to initiate.

The fitting on the right of the panel is for attaching the Oxygen gas source. The O₂ fitting type is CGA DISS type, No. 1240. (NIST or Air Liquide oxygen fittings are also available from CareFusion.)

Attaching the Gas Hoses

Oxygen Connection

Attach the Oxygen hose to the fitting on the right of the back panel (Figure 2–29).

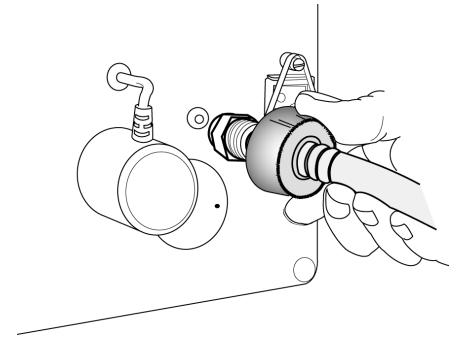

Figure 2–29: Connecting the O₂ Hose

Heliox Connection

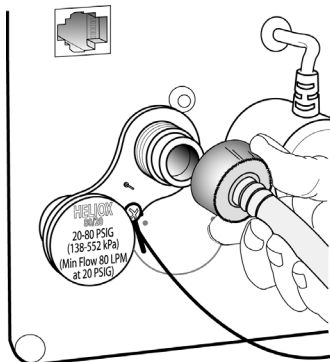

Figure 2–30: Connecting the Heliox Hose

If you have the upgrade for Heliox delivery, attach the Heliox hose to the tethered “Smart” connector fitting on the left of the back panel as shown in Figure 2–30.

The air hose will not attach to the fitting designed for Heliox and vice versa.

WARNING

Allow 90 seconds for the accumulator to purge before initiating patient ventilation with Heliox gas.

WARNING

Connection of a gas supply at the Helium-Oxygen mixture inlet that does not contain 20% oxygen can cause hypoxia or death.

Although an 80/20 mixture of Helium and Oxygen is marketed as medical grade gas, the Helium/Oxygen gas mixture is not labeled for any specific medical use.

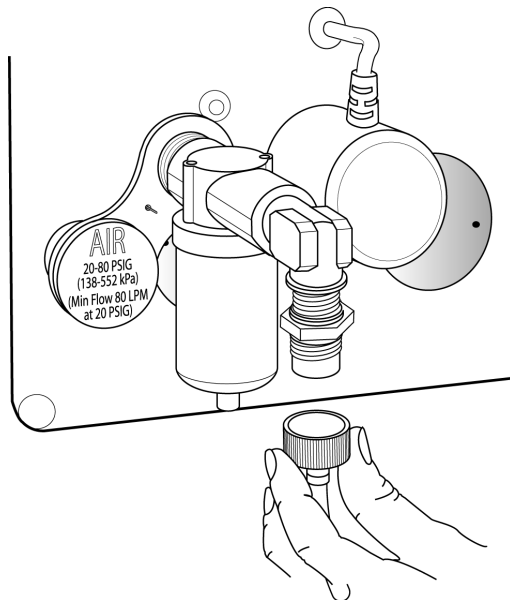
Attaching the Air Hose

Attach the Air supply hose to the “Smart” connector fitting with the integral water trap/filter on the left of the back panel as shown in Figure 2–31.

The fitting shown here is a DISS fitting. Fittings which accept NIST and Air Liquide hoses are also available from CareFusion.

The air hose will not attach to the fitting designed for Heliox and vice versa.

Figure 2–31: Attaching the Air Hose to the water trap/filter

Note:

The fitting for Air will not accept a Heliox connection and vice versa.

Utilities Screens

Configuration Tab



Figure 2–32: Utilities Screen

Alarm Loudness.

To change alarm sound levels depress and hold the increase or decrease soft keys until the desired level is reached. The “Alarm Test” banner will appear during the adjustment.

Enable / Disable O2 Alarm.

The High and Low oxygen alarms can be disabled in the event of a failure of the oxygen sensor while the ventilator is in use. To disable the alarm depress the Enable / Disable O₂ soft key, to re-enable depress the soft key again.

Note:

The oxygen alarms cannot be disabled while heliox is in use. Powering the ventilator off and back on again will automatically re-enable the oxygen alarms.

WARNING

Although disabling the oxygen alarms will not affect oxygen titration an external analyzer should be placed in line in the breathing circuit until the oxygen sensor has been replaced.

Flow Correction

Flow Correction allows for flow correction to BTPS (Body Temperature Pressure Saturated or ATPD (Ambient Temperature Pressure Dry). Default position is BTPS and should be used for all clinical applications.

ILV Mode

- To enable Independent Lung Ventilation and define the Master and Slave ventilators, access the Utilities screen from the screens menu (Figure 2–32). **ILV requires the use of a specially configured accessory cable kit (part number 16246), which is available from CareFusion.**
- With both ventilators turned off, connect the ILV cable PN 16124 to the analog port of each ventilator.
- Turn on the ventilator to be designated as the “Slave”.
- Adjust all primary and advanced settings as desired.
- Power up the “Master” ventilator.
- Select “Master” from the Utilities screen.
- Adjust all primary and advanced settings as desired.
- Connect the patient.

Note:

Ventilation will not begin until the Master ventilator has been turned on.

Each ventilator maintains independent settings for FiO_2 during independent lung ventilation. Close monitoring of set FiO_2 on each ventilator is recommended.

Confirm alarm settings on each ventilator. Each ventilator will alarm independently based on alarm settings established for that particular ventilator.

Apnea ventilation on the Slave ventilator is driven by the apnea ventilation rate of the Master ventilator only.

Should the ventilators become disconnected during ILV, only the Master ventilator will alarm for the ILV Disconnect condition. The Slave ventilator will alarm for Apnea and begin apnea ventilation at its own active settings.

WARNING

DO NOT attempt to connect a standard DB-25 cable to this receptacle. This could cause damage to the ventilator. A specially configured cable is required for ALL features associated with this connector. Contact Technical Support.

Setting up Independent Lung Ventilation (ILV)

The AVEA has a 25 pin receptacle on the rear panel (Figure 2–33) to allow for Independent Lung Ventilation (ILV) with another AVEA. The output for ILV provides a 5VDC logic signal synchronized to the breath phase of the master ventilator. Table 2–1 at the end of this section details the relevant pins for the signals carried by this connector.

Note:

This connector also carries the Analog Input and the Analog Output signals. Refer to Appendix B Specifications for Analog Output Pressure (cmH₂O/mv), flow ((ml/min)/mv) and Volume (ml/mv) conversions.

ILV connector pin configuration

To connect two AVEA ventilators together for independent lung ventilation function, the cable must be wired so that the ILV input (the slave) on one AVEA is connected to the ILV output (the master) on the other AVEA. As shown in Figure 2–33 below, the ILV slave is pin 18, and the ILV master is pin 6. In addition, at least one of the analog grounds (pins 5, 9, 10, 11, 12 or 13) must be connected. We recommend using a shielded cable.

For ILV operation:

Connect an analog ground on Vent 1 to analog ground on vent 2 (

- Figure 2–34).
- Connect Pin 6 on Vent 1(Master) to pin 18 on vent 2 (Slave).
- Connect Pin 18 on Vent 1 to pin 6 on vent 2.

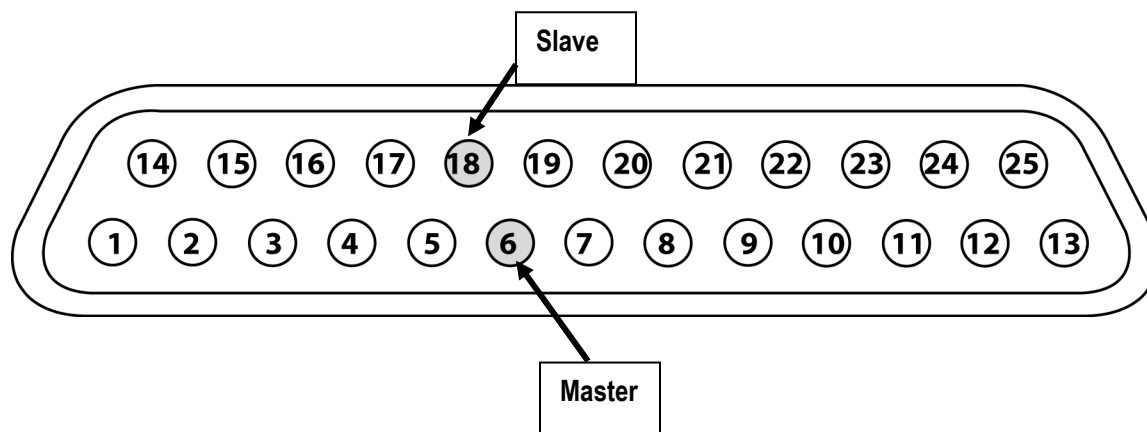

Figure 2–33: ILV Connection Pin Configuration

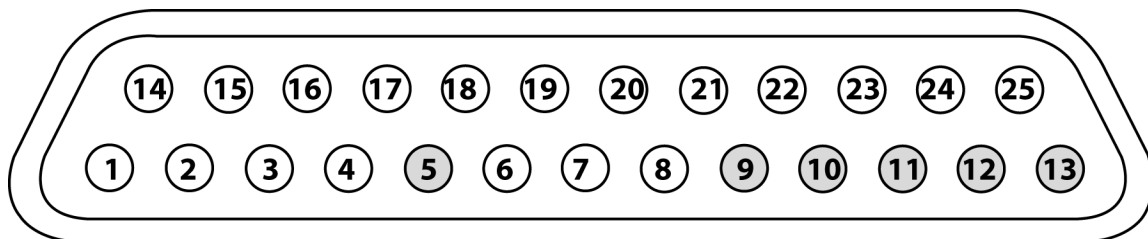

Figure 2–34: Analog Ground Pins

Note:

At least one analog ground is required for safe and accurate signal output and input. One analog ground is sufficient for any and all of the other signals.

Selecting Language .

Touch the language box and use the data dial to select the desired language. Use the Accept key to accept the change. All text displayed on the LCD screen will automatically be translated to the set language.

Note:

For ease of use all languages appear in their native text in the text selection box on the utilities screen.

Low Vte Alarm Sensitivity

Sets the number of consecutive breaths with an exhaled tidal volume below the Low Vte Alarm setting which are required to sound the alarm. The default is 3 breaths; the range is 1-5 breaths.

Increase FIO₂

Configures the step increase used during the increase oxygen maneuver. Sets the amount of oxygen the ventilator will increase above the current set FIO₂.

Example: If the Increase FIO₂ is set at 20%

 AND

 The set FIO₂ is 40%

 WHEN

 The increase FIO₂ Maneuver is activated the FIO₂ will increase to 60% for two minutes after which it will return to 40%.

The default setting for infants is 20% and 79% for Pediatric and Adult applications.

Note:

To achieve 100% delivered FIO₂ during the Increase O₂ maneuver set the Increase FIO₂ setting to its maximum of 79%.

Note:

The settings will be reset to default values when New Patient is selected in the set up menu.

Input/Output Tab

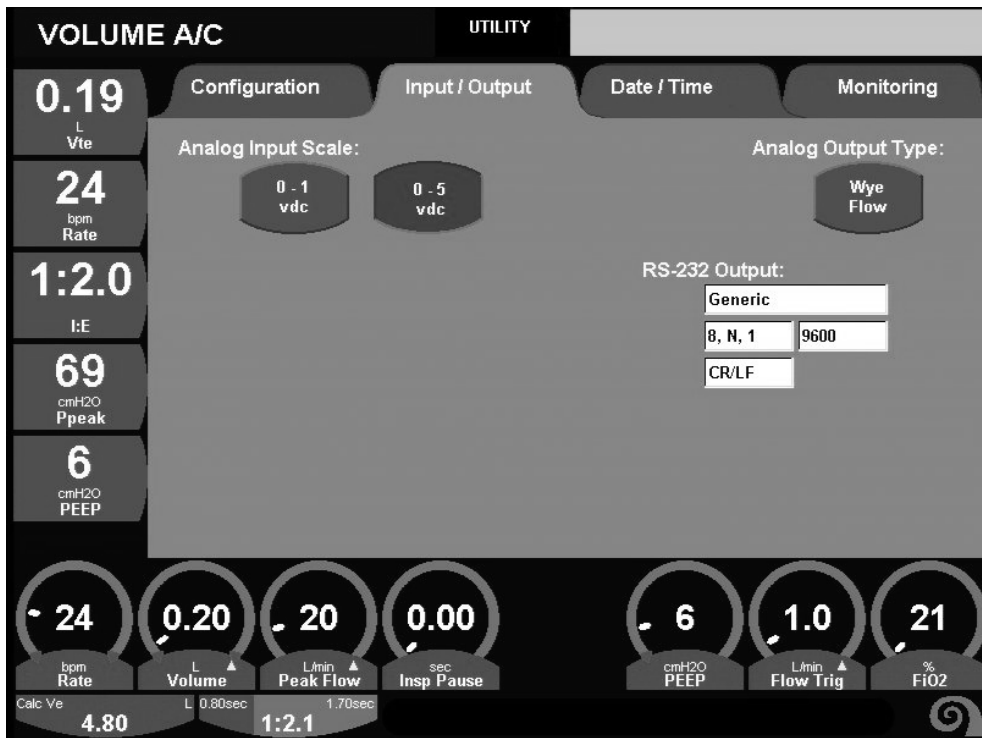

Figure 2-35: Utility Screen, Input / Output Tab

Analog Input Configuration

Under the heading “Set Analog Input Scale” there are two buttons representing two possible voltage ranges.

If the full-scale output of the device you are interfacing with is less than 1 volt, select the 0-1 volt scale button.

If it is 5V or less, select the 0-5 volt range. Select the appropriate analog scale and press the ACCEPT key to enter the configuration.

Analog Input is configured on the same connector as the ILV. The pin configuration for cables to use this feature is shown in Figure 2–36 below. Pin configuration of the connector for attachment to your other device must be supplied by the manufacturer of that device

WARNING

All applications using this connector require specially made cables. DO NOT connect a standard DB25 cable to this receptacle. This could result in damage to the ventilator. Contact Technical Support at the numbers given in Appendix A.

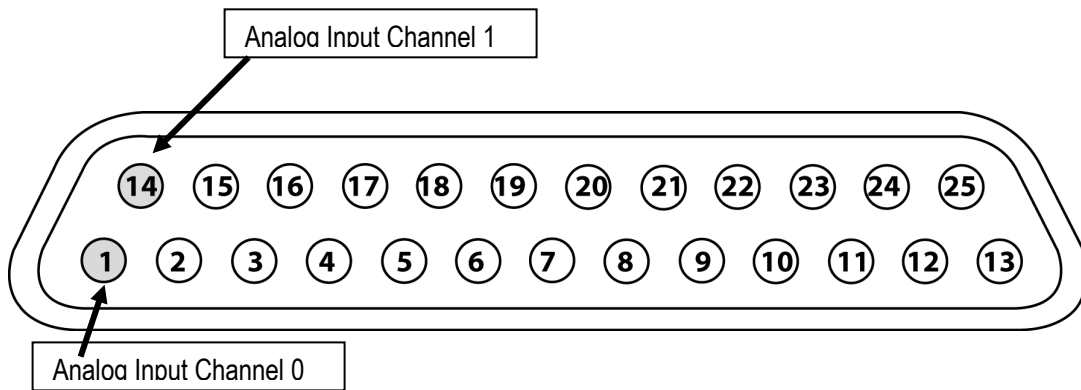

Figure 2–36: Analog Input connections

Analog Outputs

Set Analog Output Type

The analog output flow signal can be selected between **Wye Flow** (calculated flow to the patient) or **Machine Flow** (the flow measured by the inspiratory flow sensor within the ventilator).

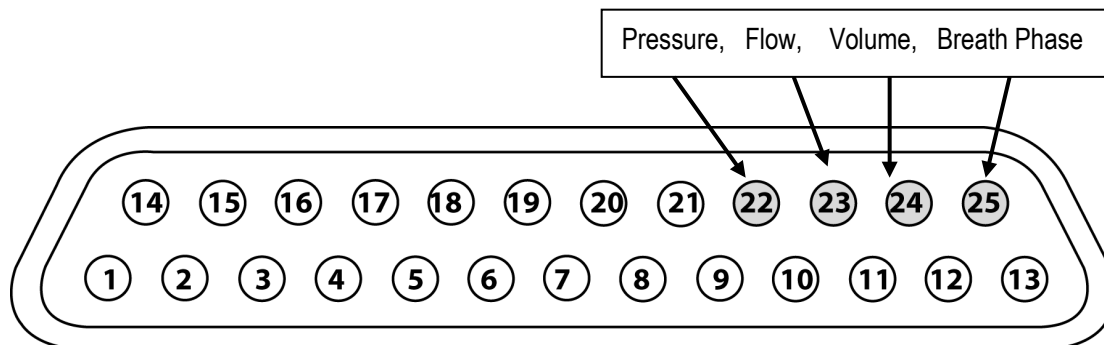

Figure 2–37: Analog Outputs Pin configuration

The pin configuration for pressure, flow, volume and breath phase analog outputs is shown above. Refer to Appendix B Specifications for Analog Output Pressure (cmH₂O/mv), flow ((L/min)/mv) and Volume (ml/mv) conversions.

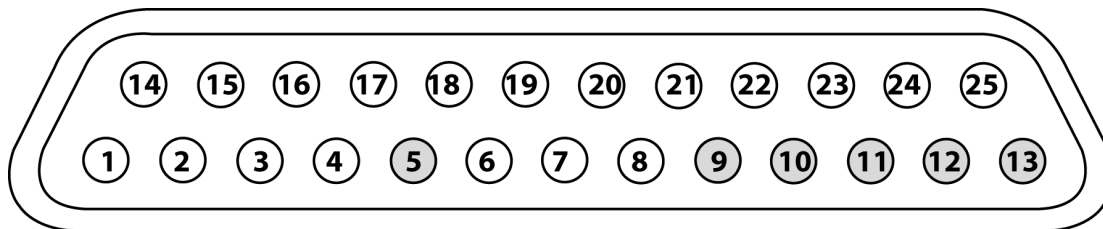

Figure 2–38: Analog Ground Pins **

Note:

At least one analog ground is required for safe and accurate signal output and input. One analog ground is sufficient for any and all of the other signals.

Table 2-1: ILV and Analog I/O pin configuration

PIN	FUNCTION
1	Analog Input Channel 0
14	Analog Input Channel 1
18	ILV In
6	ILV Out
20	Factory Use Only. DO NOT CONNECT.
22	Analog Output, PRESSURE
23	Analog Output, FLOW
24	Analog Output, VOLUME
25	Analog Output, BREATH PHASE
5, 9,10,11,12,13	Ground, Analog Note: At least one analog ground is required for safe and accurate signal output and input. One analog ground is sufficient for any and all of the other signals.

RS 232 Output

Sets the RS 232 output format for digital communications via the port labeled MIB.

The RS-232 output configuration provides the following setting choices:

Generic

Select 8, N, 1 and Baud Rates of: 9600, 2400, 4800, 9600, 19200, 38400, 57600 or 115200

or

Select CR/LF or CR Only

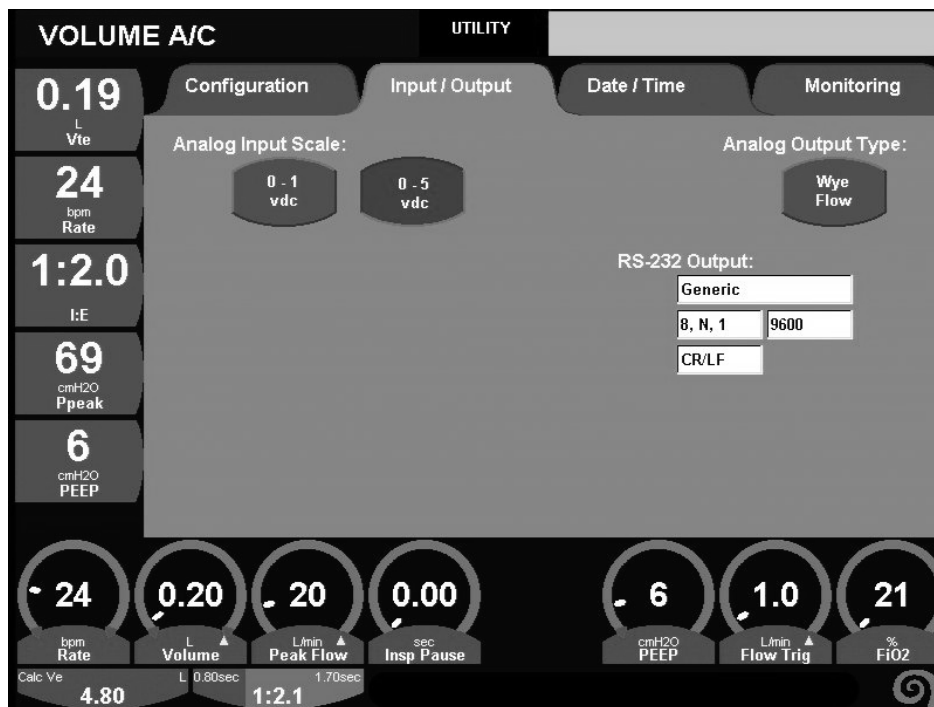

Figure 2-39: Utility Screen, Input / Output Tab, Generic RS-232 Output

VueLink

RS-232 Output:
Select Off

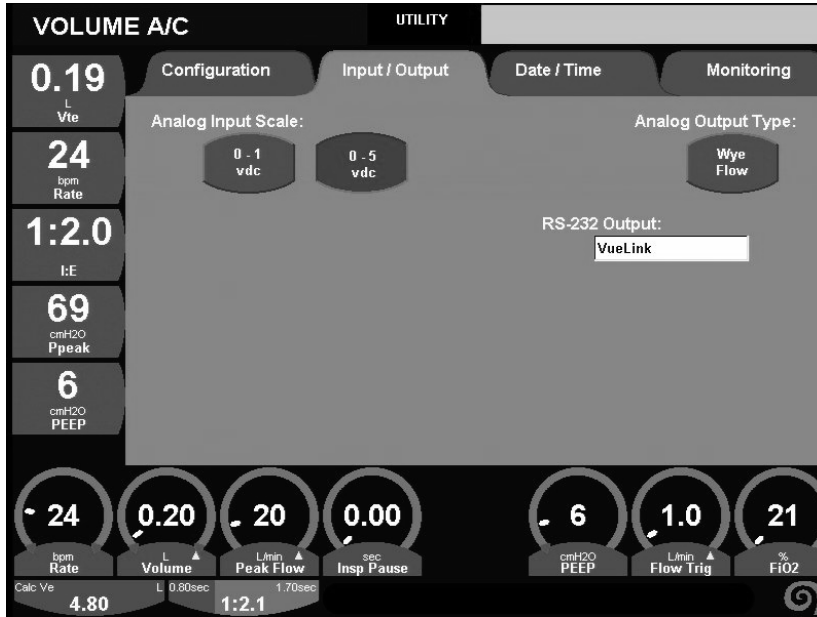

Figure 2-40: Utility Screen, Input / Output Tab, Vuelink RS-232 Output

or

VOXP

Select VOXP and either 8,N,1 / 7,N, 1 / 7, E, 1 or 7, 0, 1 and Baud Rates of: 9600, 19200, 38400, 57600, 115200

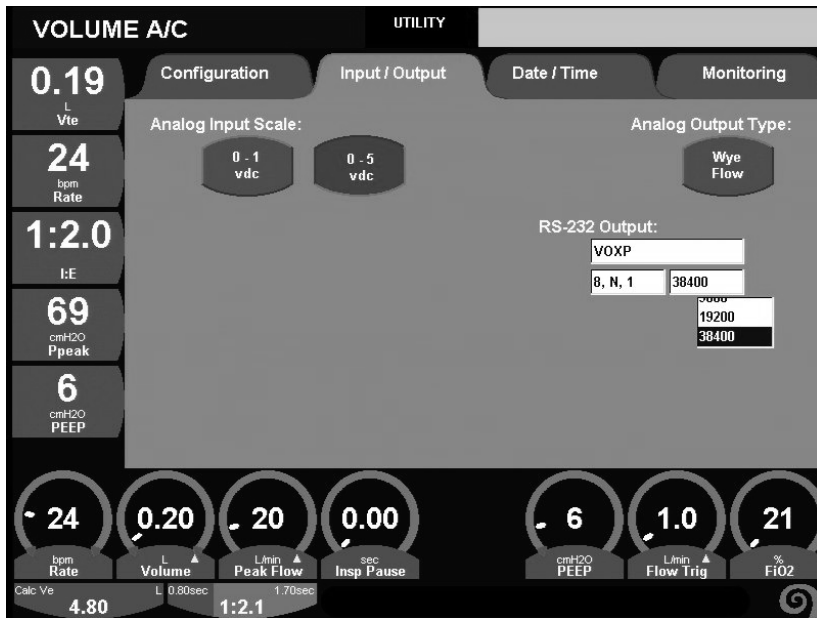

Figure 2-41: Utility Screen, Input / Output Tab, VOXP RS-232 Output

Nurse Call Connection

The AVEA can be connected to a remote nurse call system via the modular connector on the rear panel shown in Figure 2–25, E. The jack is configured to interface with normally closed (NC, open on alarm) or normally open (NO, closed on alarm) signals. Cables for both systems are available from CareFusion.

Date/Time Tab

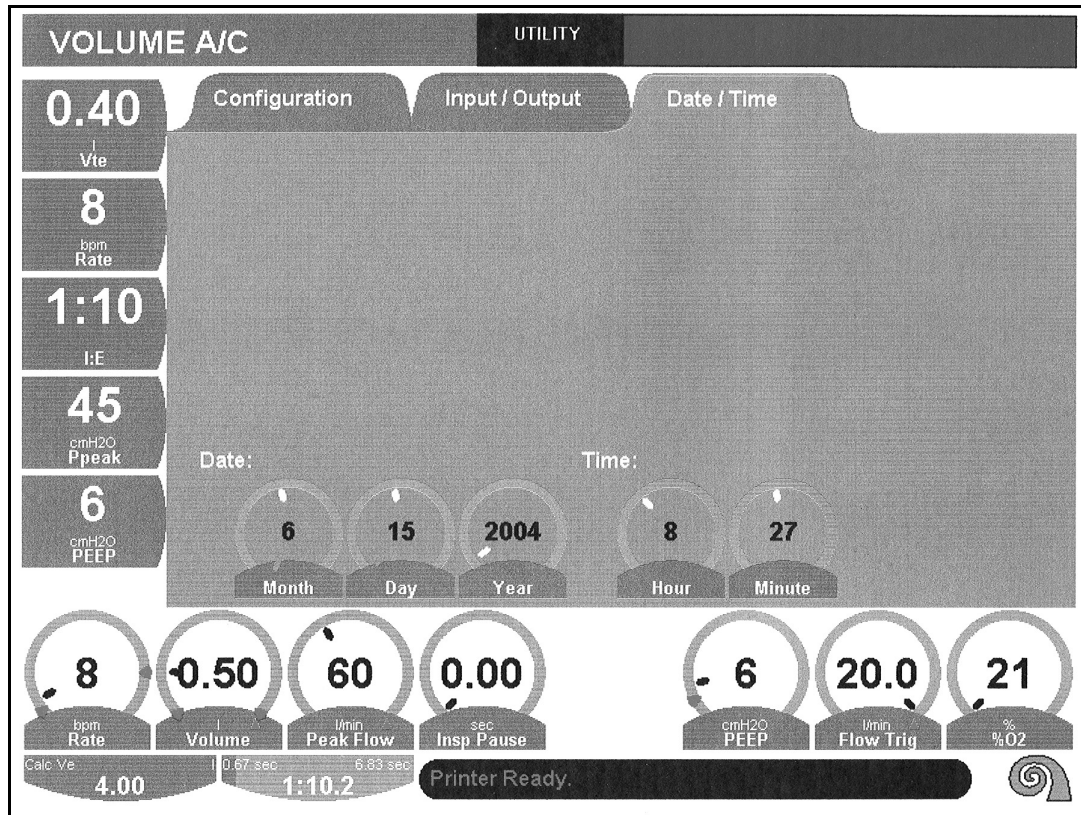

Figure 2–42: Utility Screen, Date / Time Tab

Setting the Date.

Using the touch turn touch technique use the data dial to set the correct month, day and year prior to use of the ventilator.

Setting the Time.

Using the touch turn touch technique use the data dial to set the correct time in hours and minutes prior to use of the ventilator.

Note:

After changing the date and/or time, cycle the ventilator off, then on and select “NEW PT” to ensure coordination of the EVENTS and TRENDS with the new date/time set.

Powering up the AVEA

To power up the ventilator, connect the power cord to a suitable AC power supply and turn on the power switch located on the back panel of the ventilator as shown here.

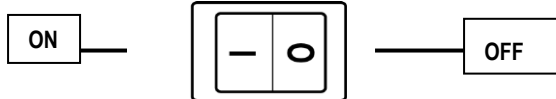

Figure 2-43: Power Switch

The power up/reboot time for this instrument is approximately 7 seconds.

WARNING

A protective ground connection by way of the grounding conductor in the power cord is essential for safe operation. If the protective ground is lost, all conductive parts, including knobs and controls, which may *appear* to be insulated, can render an electric shock. To avoid electrical shock, plug the power cord into a properly wired receptacle, use only the power cord supplied with the ventilator, and make sure the power cord is in good condition.

WARNING

If the integrity of the external power earth conductor arrangement is in doubt, unplug the ventilator from the mains AC and operate it from its internal battery or the optional external battery.

User Verification Test

WARNING

The User Verification Test should always be performed off patient.

The User Verification Test consists of the three following sub-tests and should be performed before connection to a new patient.

- **The POST test:**
The **POST** or Power On Self Test is transparent to the user and will only message if the ventilator encounters an error. Normal ventilation commences at the culmination of the POST.
 - **The Extended Systems Test (EST).** During this test the ventilator will perform:
 - Patient circuit leak testing
 - Patient circuit compliance measurement
 - Two point calibration of the oxygen sensor
 - **The Alarms Test** consisting of verification for:

High Ppeak alarm	High O ₂ alarm
Ext High Ppeak Alarm	Low Ppeak alarm
Low Ve alarm	Loss of AC alarm
High Ve alarm	Circuit Disconnect
High Vt alarm	High Rate Alarm
Low O ₂ alarm	Apnea Interval alarm
Low Vt alarm	Low PEEP alarm

CAUTION

Although failure of any of the above tests will not prevent the ventilator from functioning, it should be checked to make sure it is operating correctly before use on a patient.

The Power on Self Test (POST)

This test is run automatically and performs the following checks:

- Processor Self Check
- ROM Check Sum
- RAM Test

The POST will also check the audible alarms and the LEDs at which time the audible alarm sounds and the LEDs on the User Interface Module flash. Normal ventilation commences at the culmination of the POST.

The Extended Systems Test (EST)

The EST function is accessed from the Setup screen as shown here. Press the SETUP membrane button to the lower left of the UIM to open this screen.

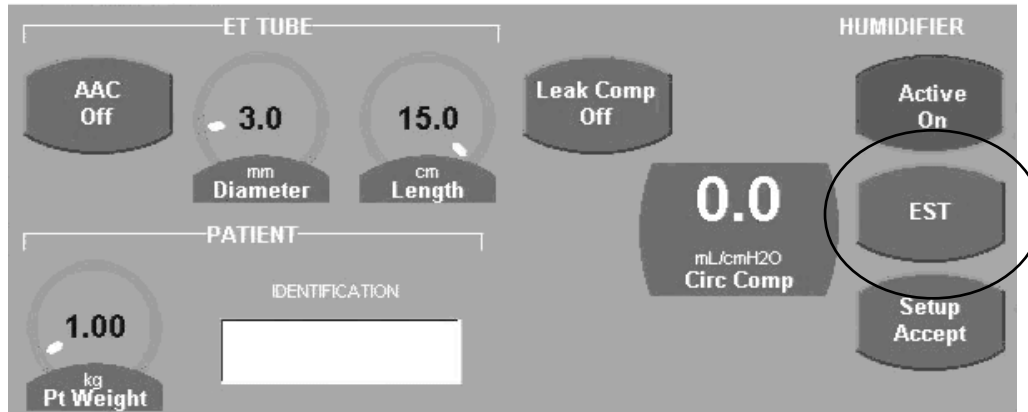

Figure 2-44: Setup Screen

Press the EST touch screen button to select it.

A message will appear instructing you to remove the patient and block the patient wye.

After confirming that the patient has been disconnected and the circuit wye blocked press the Continue (Cont) button.

The ventilator will perform the EST and display a countdown clock.

During this test the ventilator will perform:

- Patient circuit leak test
- Patient circuit compliance measurement
- Two point calibration of the oxygen sensor

The patient circuit compliance measurement and leak test are performed simultaneously with the oxygen sensor calibration. The maximum time for the EST is 90 seconds. To restart the EST at any time select the Cancel button to return to the set up screen.

After each test is complete the ventilator will display a “Passed” or “Failed” message next to the corresponding test.

Once the test is complete press the continue button to return to the set up screen.

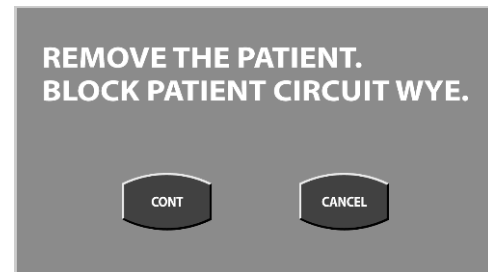

Figure 2.46a Remove Patient Instruction

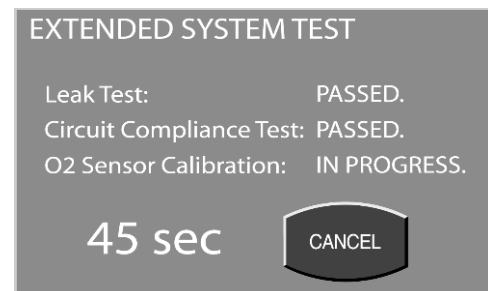

Figure 2.46b In progress EST

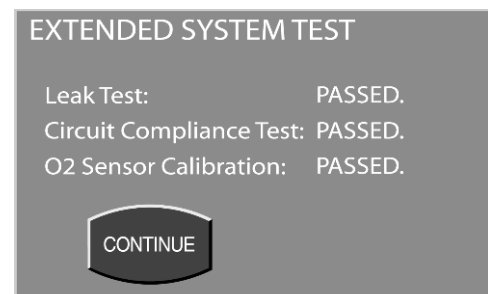

Figure 2.46c Completed EST

Figure 2-45: EST Screens

The “SET UP ACCEPT” key must be pressed in order for the AVEA to retain the circuit compliance measurement. At this point, even after power cycling off, if “SAME PT” is selected, the circuit compliance measurement will continue to be retained. If “NEW PT” is selected, the EST will be required to use this feature.

Note:

If you do not connect the ventilator to an oxygen supply, the O₂ Sensor Calibration will immediately fail.

The Alarms Test

Note:

To ensure proper calibration of the oxygen sensor, you should always perform an EST prior to conducting Manual Alarms Testing.

WARNING

User Verification Testing should always be done off patient.

CAUTION

Following each alarm verification test, ensure that the alarm limits are reset to the recommended levels shown in this chapter before proceeding to the next test.

Test Setup Requirements:

	Adult Setting	Pediatric Setting	Neonate Setting
Air Supply Pressure	> 30 psig (2.1 bar)	Same	Same
O₂ Supply Pressure	> 30 psig (2.1 bar)	Same	Same
AC Line Voltage	115 ± 10 VAC	Same	Same
Patient Circuit	6' (2 m) Adult	6' (2 m) Adult	Infant
Compliance	20 ml/cmH ₂ O	20 ml/cmH ₂ O	N/A
Resistance	5 cmH ₂ O/L/sec	5 cmH ₂ O/L/sec	N/A

To perform the Alarms Test on the AVEA ventilator using default settings, complete the following steps (A table describing the default settings for Adult, Pediatric and Neonatal patient sizes is included at the end of the Alarms Test section).

1. Make the appropriate connections for air and O₂ gas supply. Connect the power cord to an appropriate AC outlet. Attach an appropriate size patient circuit and test lung to the ventilator.
2. Power up the ventilator and select NEW PATIENT when the Patient Select Screen appears. Accept this selection by pressing PATIENT ACCEPT. This will enable default settings for the Manual Alarms Test.
3. Select the appropriate patient size for your test (Adult, Pediatric or Neonate) from the Patient Size Select Screen. Accept this selection by pressing SIZE ACCEPT. Set Humidifier Active off.
4. Make any desired changes or entries to the Ventilation Setup Screen and accept these by pressing SETUP ACCEPT.
5. Press Alarm Limits button on the upper right of the user interface.

6. Verify that no alarms are active and clear the alarm indicator by pressing the alarm reset button on the upper right of the user interface.
7. Set the % O₂ control to 100%. Disconnect the Oxygen sensor from the back panel of the ventilator and verify that the Low O₂ alarm activates. Return the O₂ control setting to 21% with the sensor still disconnected from the rear panel. Remove sensor from back panel. Provide blow-by to the sensor from an external oxygen flow meter. Verify that the High O₂ alarm activates. Return the % O₂ to 21%, reconnect the Oxygen sensor to the back panel. Clear all alarm messages by pressing the alarm reset button.
8. Set PEEP[®] to 0. Set Low PEEP alarm to 0. Disconnect the patient wye from the test lung. Verify that the Low Ppeak alarm activates, followed by the Circuit Disconnect alarm. This second alarm should activate within 15 seconds or one breath cycle. Reconnect the test lung to the circuit clear the alarm by pressing the reset button.
9. Disconnect the AC power cord from the wall outlet. Verify that the Loss of AC alarm activates. Reconnect the AC power cord. Clear the alarm by pressing the reset button.
10. Occlude the exhalation exhaust port. Verify that the High Ppeak alarm activates, followed 5 seconds later by the activation of the Ext High Peak Alarm.
11. Set the control setting for rate to 1 bpm. Verify that Apnea Interval alarm activates after the default setting of 20 seconds. Return the control setting to its default value and clear the alarm by pressing the reset button.
12. Set the Low PEEP alarm setting to a value above the default control setting for PEEP on your ventilator. Verify that the Low PEEP alarm activates. Return the alarm setting to its default value and clear the alarm by pressing the reset button.
13. Set the High Ppeak alarm setting to a value below the measured peak pressure or in neonatal ventilation, the default control setting for Inspiratory Pressure on your ventilator. Verify that the High Ppeak alarm activates. Return the alarm setting to its default value and clear the alarm by pressing the reset button.
14. Set the Low Ve alarm setting to a value above the measured Ve on your ventilator. Verify that the Low Ve alarm activates. Return the alarm setting to its default value and clear the alarm by pressing the reset button.
15. Set the High Ve alarm setting to a value below the measured Ve on your ventilator. Verify that the High Ve alarm activates. Return the alarm setting to its default value and clear the alarm by pressing the reset button.
16. Set the High Vt alarm setting to a value below the set Vt on your ventilator. Verify that the High Vt alarm activates. Return the alarm setting to its default value and clear the alarm by pressing the reset button.
17. Set the Low Vt alarm setting to a value above the set Vt on your ventilator. Verify that the Low Vt alarm activates after the number of breaths set in the Utility screen for VTE sensitivity. Return the alarm setting to its default value and clear the alarm by pressing the reset button.
18. Set the High Rate alarm to a value below the default control setting for rate on your ventilator. Verify that the alarm activates. Return the alarm to its default setting and clear the alarm by pressing the reset button.
19. Occlude the inspiratory limb of the patient circuit. Verify that the Circuit Occlusion alarm activates.

CAUTION

Although failure of any of the above tests will not prevent the ventilator from functioning, it should be checked to make sure it is operating correctly before use on a patient.

Default Settings for Adult, Pediatric and Neonate

The Default settings are the operational settings that take effect when you press the New Patient button on power up.

Ventilation Setup

	Adult Setting	Pediatric Setting	Neonate Setting
ET tube Diameter	7.5 mm	5.5 mm	3.0 mm
ET Tube Length	30 cm	26 cm	15 cm
Artificial Airway Compensation	Off	Off	Off
Leak Compensation	Off	Off	Off
Circuit Compliance Compensation (Circ Comp)	0.0 ml/cmH ₂ O	0.0 ml/cmH ₂ O	0.0 ml/cmH ₂ O NOT active in Neonates.
Humidification	Active On	Active On	Active On
Patient Weight	1 kg	1 kg	1 kg

Primary Controls

	Adult Setting	Pediatric Setting	Neonate Setting
Breath Type/Mode	Volume A/C	Volume A/C	TCPL A/C
Breath Rate (Rate)	12 bpm	12 bpm	20 bpm
Tidal Volume (Volume)	500 ml	100 ml	2.0 ml
Peak Flow	60 L/min	20 L/min	8 L/min
Inspiratory Pressure (Insp Pres)	15 cmH ₂ O	15 cmH ₂ O	15 cmH ₂ O
Inspiratory Pause (Insp Pause)	0.0 sec	0.0 sec	0.0 sec
Inspiratory Time (Insp Time)	1.0 sec	0.75 sec	0.35 sec
PSV	0 cmH ₂ O	0 cmH ₂ O	0 cmH ₂ O
PEEP	6 cmH ₂ O	6 cmH ₂ O	3 cmH ₂ O
Inspiratory Flow Trigger (Flow Trig)	1.0 L/min	1.0 L/min	0.5 L/min
%O ₂	40%	40%	40%

Advanced Settings

	Adult Setting	Pediatric Setting	Neonate Setting
Vsync	0 (off)	0 (off)	N/A
Vsync Rise	5	5	N/A
Sigh	0 (off)	0 (off)	N/A
Waveform	1 (Dec)	1 (Dec)	1 (Dec)
Bias Flow	2.0 L/min	2.0 L/min	2.0 L/min
Inspiratory Pressure Trigger (Pres Trig)	3.0 cmH ₂ O	3.0 cmH ₂ O	3.0 cmH ₂ O
PSV Rise	5	5	5
PSV Cycle	25%	25%	10%

	Adult Setting	Pediatric Setting	Neonate Setting
PSV Tmax	5 sec	0.75 sec	0.35 sec
Machine Volume (Mach Vol)	0 L	0 ml	0 ml
Volume Limit (Vol Limit)	2.50 L	500 ml	300.0 ml
Inspiratory Rise (Insp Rise)	5	5	5
Flow Cycle	0% (off)	0% (off)	0% (off)
T High PSV	Off	Off	N/A
T High Sync	0%	0%	N/A
T Low Sync	0%	0%	N/A
Demand Flow	On	On	On

Alarm Settings

	Adult Setting	Pediatric Setting	Neonate Setting
High Rate	75 bpm	75 bpm	75 bpm
High Tidal Volume (High Vt)	3.00 L	1000 ml	300 ml
Low Tidal Volume (Low Vt)	0.0 L	0.0 ml	0.0 ml
Low Exhaled Minute Volume (Low Ve)	1.0 L	0.5 L	0.5 L
High Exhaled Minute Volume (High Ve)	30.0 L/min	30.0 L/min	5.0 L/min
Low Inspiratory Pressure (Low Ppeak)	8 cmH ₂ O	8 cmH ₂ O	5 cmH ₂ O
High Inspiratory Pressure (High Ppeak)	40 cmH ₂ O	40 cmH ₂ O	30 cmH ₂ O
Low PEEP	3 cmH ₂ O	3 cmH ₂ O	1 cmH ₂ O
Apnea Interval	20 sec	20 sec	20 sec

Auxiliary Controls

	Adult Setting	Pediatric Setting	Neonate Setting
Manual Breath	---	---	---
Suction	---	---	---
↑ O₂	79%	79%	20%
Nebulizer	---	---	---
Inspiratory Hold (Insp Hold)	---	---	---
Expiratory Hold (Exp Hold)	---	---	---

AVEA User Verification Test Checklist

Machine Serial Number: _____ Test Date: _____

TEST	PASS	FAIL
Automated Tests		
Power-on self test	<input type="checkbox"/>	<input type="checkbox"/>
Patient circuit leak test	<input type="checkbox"/>	<input type="checkbox"/>
Patient circuit compliance measurement	<input type="checkbox"/>	<input type="checkbox"/>
Two point calibration of the oxygen sensor	<input type="checkbox"/>	<input type="checkbox"/>
	<input type="checkbox"/>	<input type="checkbox"/>
Manual Alarms Checks		
High Rate Alarm	<input type="checkbox"/>	<input type="checkbox"/>
Low Vte Alarm	<input type="checkbox"/>	<input type="checkbox"/>
High Vte Alarm	<input type="checkbox"/>	<input type="checkbox"/>
Low Ve Alarm	<input type="checkbox"/>	<input type="checkbox"/>
High Ve Alarm	<input type="checkbox"/>	<input type="checkbox"/>
Low Ppeak Alarm	<input type="checkbox"/>	<input type="checkbox"/>
High Ppeak Alarm	<input type="checkbox"/>	<input type="checkbox"/>
Low PEEP Alarm	<input type="checkbox"/>	<input type="checkbox"/>
Apnea Interval Alarm	<input type="checkbox"/>	<input type="checkbox"/>
Extended High Ppeak Alarm	<input type="checkbox"/>	<input type="checkbox"/>
Circuit Disconnect Alarm	<input type="checkbox"/>	<input type="checkbox"/>
Circuit Occlusion Alarm	<input type="checkbox"/>	<input type="checkbox"/>
Loss of AC Alarm	<input type="checkbox"/>	<input type="checkbox"/>
High O ₂ Alarm	<input type="checkbox"/>	<input type="checkbox"/>
Low O ₂ Alarm	<input type="checkbox"/>	<input type="checkbox"/>

Signature of tester: _____

Title _____

AVEA Troubleshooting

Remove ventilator from patient with any potential problem

Symptom	Problem	Solution(s)
Will not pass EST - Fails Leak	Circuit wye not fully occluded	Ensure circuit wye is fully occluded
	Leak in patient circuit	Check for leaks in circuit and reseal circuit connections to ventilator. Replace circuit if necessary.
	Filter cartridge not properly seated	Remove exhalation cartridge and check condition of connections. Reinstall and recheck. Replace if necessary
	Leak in exhalation corner	Replace exhalation diaphragm.
Will not pass EST - Fails O ₂ calibration	Connector on O ₂ sensor not connected properly	Check sensor connection
	Inlet gas pressure too low	Verify inlet air and oxygen pressure above 20psig
	Defective O ₂ sensor	Replace O ₂ Sensor
No reading from proximal flow sensor	Sensor / Patient size incompatible	See the operators manual for correct sensor/mode configurations
	Sensor not connected	Ensure sensor properly connected at both the patient wye and at the ventilator.
	Loose external connection	Check external connection
	Defective sensor	Replace sensor
	Internal fault	Call Technical Service
V _{ti} > V _{te} when operating without proximal flow sensors	Normal Condition when operating on test lung.	No action required
	Normal if readings are within ventilator accuracy specifications of +/-10%	No action required if within specification
	Defective expiratory flow sensor	Clean/replace expiratory flow sensor
	Leak in patient circuit, water collector or exhalation system	Verify with leak test
V _{te} > V _{ti}	Normal if readings are within ventilator accuracy specifications of +/-10%	No action required if within specification
	Defective expiratory flow sensor	Clean/replace expiratory flow sensor
	Leak in patient circuit, water collector or exhalation system	Verify with leak test
	Internal fault	Call Technical Service

Symptom	Problem	Solution(s)
Volume waveform above or below baseline on patient with internal sensor	Humidifier "Active on/off" set incorrectly	Set for "Active on" for humidifier, "Active off" for "HME"
	Normal if readings are within ventilator accuracy specifications of +/-10%	No action required if within specification
	Bad expiratory flow sensor	Clean or replace expiratory flow sensor
	Internal fault	Call Technical Service
Volumes become inaccurate over time	Foreign material on flow sensor	Clean/replace sensor
	Internal fault	Call Technical Service
Nebulizer output absent	Ventilator running on compressor	Connect wall air
	Flow less than 15 L/min	Increase flow if appropriate
	Internal fault	Call Technical Service
FiO ₂ monitor inaccurate or reads "****"	O ₂ sensor requires calibration	Perform EST
	O ₂ sensor at end of life	Replace O ₂ Sensor
PEEP too high	Exhalation filter cartridge clogged or saturated	Replace cartridge
	Defective exhalation diaphragm	Change exhalation diaphragm
Unit will not run on A/C power	Blown fuse on power entry module	Replace fuse
	Power cord not connected to mains power	Check connections
Unit will not run properly on battery	Battery not sufficiently charged	Internal battery requires at least 4 hours to be fully charge. External battery requires at least 12 hours with green LED lit for a full charge.
Improper charge level indicator - Internal battery	Excessively discharged battery	Requires at least 4 hours for full charge
<ul style="list-style-type: none"> The internal battery does not operate for the specified time. The battery charge level indicator LED is green, but the battery operation time is less than specified. The batteries do not appear to maintain adequate charge. 	Maintenance and testing required.	Perform Internal Battery Charge Monitor Reset

Symptom	Problem	Solution(s)
Improper charge level indicator - External battery	Excessively discharged battery	Requires at least 12 hours for full charge
	Loose connections	Check connections
Decreased run time on battery	Battery not fully charged	Internal battery requires at least 4 hours for full charge. External battery requires a minimum of 12 hours for a full charge.
	Defective battery	Call technical Service
Does not run on compressor	Internal fault	Call Technical Service
Auto triggering	Improper sensitivity settings	Check flow and pressure trigger settings
	Circuit leaks	Perform EST and correct leaks as required. Bias Flow should be set to approximately 1.5 l/min greater than Flow Trigger setting.
	Demand Flow turned off	Turn on Demand Flow
Vent INOP display	System fault	Call Technical Service
Low gas alarm on compressor	Minute volume exceeds 40 L/min	Reduce minute volume
"Loss of gas" alarm	Air/Heliox connector not properly connected	Insure proper connection
	Internal fault	Call Technical Service
Device Error indicator	Defective sensor	Replace sensor
	Exhalation flow sensor not connected	Check connections
	O ₂ sensor connector not connected	Check O ₂ sensor
	Defective O ₂ sensor	Replace O ₂ sensor
	Internal fault	Call Technical Service
	Improper connection sequence	External battery connection should be made with AC power disconnected.
NCPAP Pressure Limit	Occlusion of expiratory limb of patient circuit.	Check expiratory limb for kinks and/or water
	Occluded expiratory filter	Replace expiratory filter

Symptom	Problem	Solution(s)
Low NCPAP Pressure	Circuit disconnect Circuit leak Patient interface leak	Check circuit Check patient interface
High NCPAP Pressure	Patient circuit occlusion Water in circuit Patient interaction	Check patient circuit Check nasal prongs
Circuit Disconnect	Patient circuit disconnect	Check patient circuit
Inaccurate barometric pressure reading	Barometer could require calibration	Call CareFusion Technical Support.

This page intentionally left blank

Chapter 3: Ventilator Operation

Membrane Buttons and LEDs

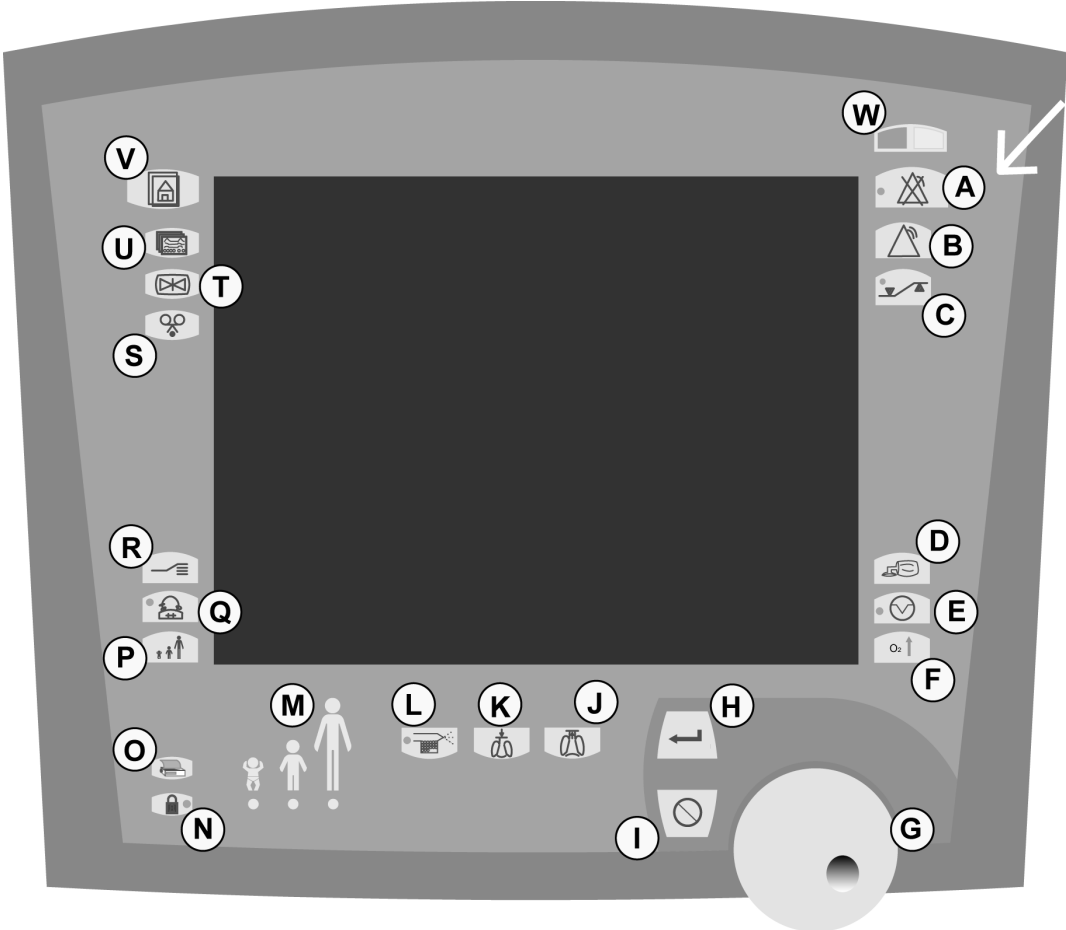

Figure 3.1a User Interface Module (International) Showing Button Icons

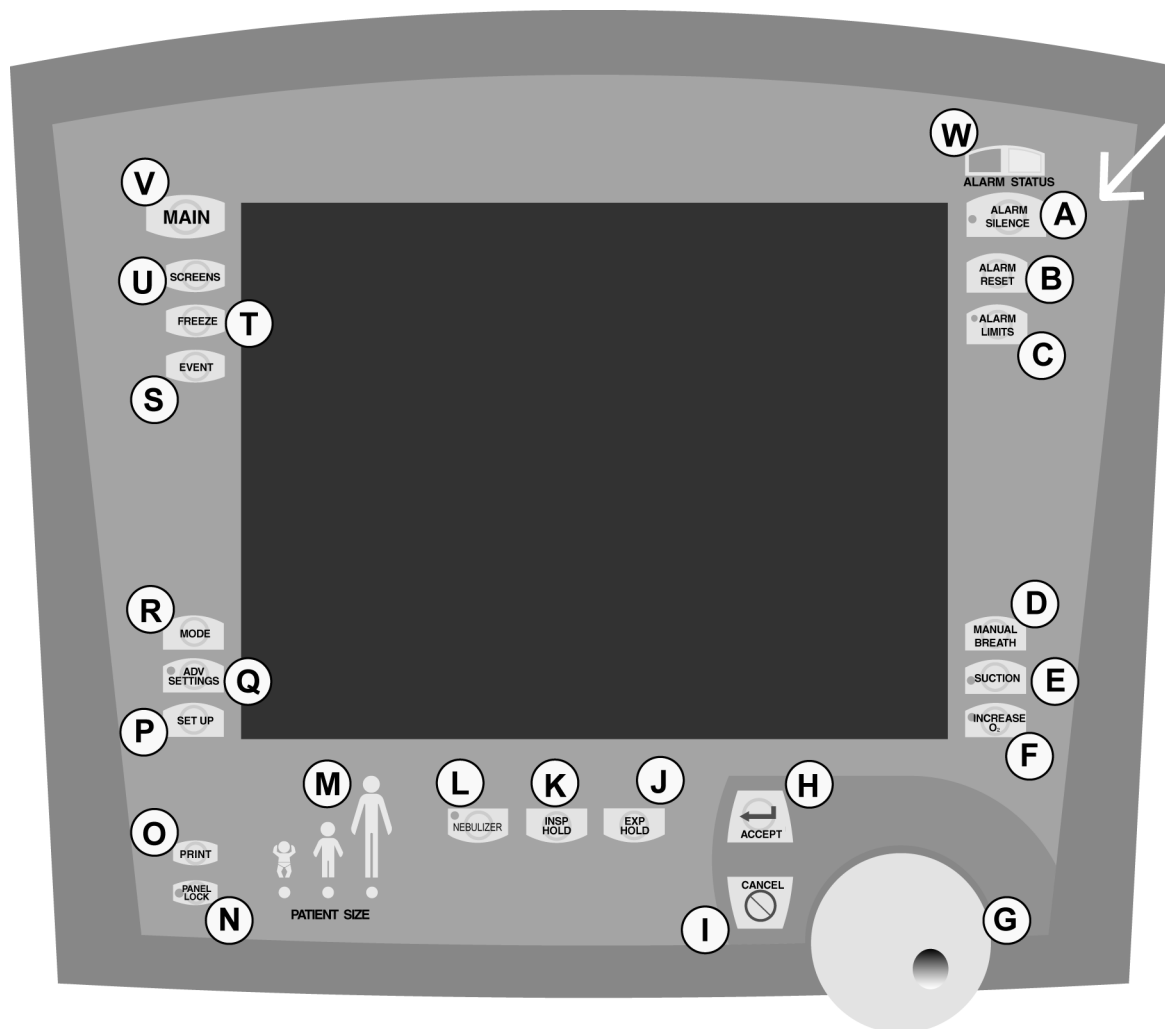

Figure 3.1b User Interface Module (English) Showing Button Labels

Figure 3–1: User Interface Module

The Membrane buttons are the UIM controls, which surround the Touch Screen. Moving clockwise around the UIM from the top right (see arrow), they are:

A. **Alarm Silence (LED)**

Pressing this button will disable the audible portion of an alarm for 2 minutes (± 1 second) or until the Alarm Silence button is pressed again. This button is not functional for a VENT INOP alarm.

Note:

Pressing the alarm silence button will not prevent the audible alarms sounding again later for certain alarm conditions.

B. **Alarm Reset**

Cancels the visual indicator for alarms that are no longer active.

C. **Alarm Limits**

Opens the alarm limits screen for data entry or adjustment. Toggles the screen on and off.

Note:

Pressing the Freeze button while the Alarm Limits window is open will automatically close the window and freeze the graphics.

D. **Manual Breath**

Pressing this button during the expiration phase of a breath delivers a single mandatory breath at current ventilator settings. No breath is delivered if the key is pressed during inspiration.

Note:

The Manual Breath button is not active in APRV / BIPHASIC.

E. **Suction (LED)**

Pressing this button initiates a “Disconnect for Suction” maneuver.

The ventilator will:

- Enable an “Increase % O₂” maneuver for 2 minutes (see Increase O₂ below).
- While the circuit disconnect alarm is active, the ventilator will stop cycling and set a bias flow. The ventilator will automatically detect the patient upon reconnection and resume normal ventilation.
- Silences alarms for 120 seconds.

If the SUCTION key is pressed again during the 2 minutes that the “disconnect for suction” maneuver is active, the maneuver will be cancelled.

F. **Increase O₂**

When this key is pressed, the ventilator increases the oxygen concentration delivered to the patient for 2 minutes. If the ↑ %O₂ key is pressed again within this two-minute period, the maneuver is cancelled and the ventilator will return to prior settings.

Defaults:	+20% Neonatal; 79% Adult/Pediatric
Adult/Pediatric:	79% above the set % O ₂
Neonate:	20% above the set % O ₂ or 100%, whichever is less

To configure the Increase FIO₂:

Access the Configuration tab on the Utilities Screen:

Increase FIO₂:

Configures the step increase used during the increase oxygen maneuver. Sets the amount of oxygen the ventilator will increase above the current set FIO₂.

Example: If the Increase FIO₂ is set at 20%

 AND

 The set FIO₂ is 40%

 WHEN

 The increase FIO₂ Maneuver is activated the FIO₂ will increase to 60% for two minutes after which it will return to 40%.

The default setting for infants is 20% and 79% for Pediatric and Adult applications.

Note:

The settings will be reset to default values when New Patient is selected in the setup

Note:

To achieve 100% delivered FIO₂ during the Increase O₂ maneuver set the Increase FIO₂ setting to its maximum of 79%.

WARNING

Heliox delivery will be interrupted for the time that either the "Suction" or the "Increase O₂" buttons are pressed during administration of Heliox. Tidal volume may be affected after the 2-minute "timeout" period, or when the button is pressed, until the accumulator has been purged.

G. Data dial

Changes the values for a selected field on the touch screen.

H. Accept

Accepts data entered into a field on the touch screen.

I. Cancel

Cancels data entered into a field on the touch screen. The ventilator will continue to ventilate at current settings.

J. Expiratory Hold

When the EXP HOLD button is pressed, at the start of the next breath interval the ventilator will not allow the patient to inspire or exhale for a maximum of 20 seconds (adult/pediatric) for breath rates 20 and less, 25 seconds for breath rates greater than 20, or 3 seconds (neonate). **Expiratory Hold is NOT active in TCPL breaths.**

K. Inspiratory Hold (Manual)

When the INSP HOLD button is pressed, once the preset of a volume control or pressure control breath has been delivered, the patient will not be allowed to exhale for a maximum of 3.0 seconds (± 0.1 second).

L. Nebulizer

The ventilator supplies blended gas to the nebulizer port at 10 ± 1.5 psig (0.7 bar) when an in-line nebulizer is attached and the Nebulizer key is pressed, provided that the calculated delivered flow is ≥ 15 L/min.

Delivery of the nebulized gas is synchronized with the inspiratory phase of a breath and lasts for 20 minutes. Press the Nebulizer key a second time to end the treatment prior to the end of the 20-minute period.

CAUTION

Use of an external flow source to power the nebulizer is not recommended.

WARNING

Using the nebulizer may impact delivered tidal volumes.

Note:

Do not operate the nebulizer while using heliox

M. Patient Size

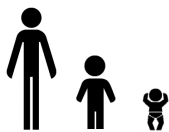

The Patient Size Indicators for Adult, Pediatric, and Neonate at the bottom of the UIM show which patient size is currently selected. These LED indicators have no associated membrane button on the UIM.

Note:

The ventilator will not allow patient size changes when the active mode of ventilation is not available in the new patient size selection. The ventilator will display a message instructing you to first change the ventilation mode. For example, in neonatal ventilation with TCPL active, you cannot change to a pediatric or adult patient size without first changing the mode to one available for those patients.

The ventilator will also not allow size changes if Machine Volume is active. A message displays indicating that Machine Volume must first be turned off before making a patient size change.

N. Panel Lock (LED)

The LOCK key disables all front panel and screen controls except MANUAL BREATH, Suction, ↑ %O₂, ALARM RESET, ALARM SILENCE, and LOCK.

O. Print

The PRINT key outputs the contents of the currently displayed screen to a suitably connected parallel printer.

P. Set-up

Opens the ventilator Setup screen.

Note:

Pressing the Set-Up button a second time before accepting Set-Up will close the window and restore the previous settings. The Set-Up screen uses an on screen accept button. To change patient size without selecting new patient requires that patient Set-Up be accepted after selecting patient size.

Q. Advanced Settings (LED)

Opens the Advanced Settings screen for data entry or adjustment. Toggles the screen on & off.

Note:

Pressing the Freeze button while the Advanced Setting window is open will automatically close the window and freeze the graphics.

R. Mode

Opens the Mode Select screen for data entry or adjustment toggles the screen on or off. Pressing the Mode indicator at the top of the touch screen will also access the screen.

Note:

Pressing the Mode button a second time before accepting the Mode will close the window and restore the previous settings. The Mode screen uses an on screen accept button.

S. Event

Records an event for future reference. Some events are recorded automatically others can be logged manually to display in this screen. See "Chapter 4: Monitors, Displays and Maneuvers" for a full list of events.

T. Freeze

The FREEZE key freezes the current screen and suspends real-time update of screen data until pressed again. While the screen is frozen, a scrollable cursor appears. The Data Dial can be used to scroll the cursor through data points on waveform, loop or trend screens. To restore the screen to active press the Freeze button a second time.

Figure 3–2 shows a flow/volume loop in “freeze” mode. The cursors trace the “frozen” loop curve along an X-Y plot line. The values along the curve of the loop are displayed as shown below.

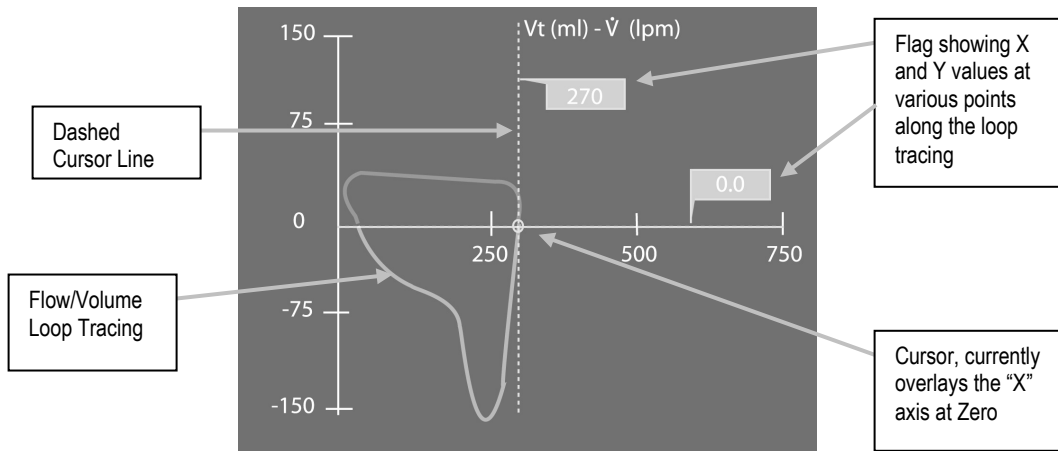

Figure 3–2: Flow/Volume Loop in Freeze Mode

U. Screens

Opens the Screen Selection box (Figure 3–3). You can also open this by pressing the Screen indicator in the top center of the touch screen.

Note:

Pressing the Screens button a second time closes the window.

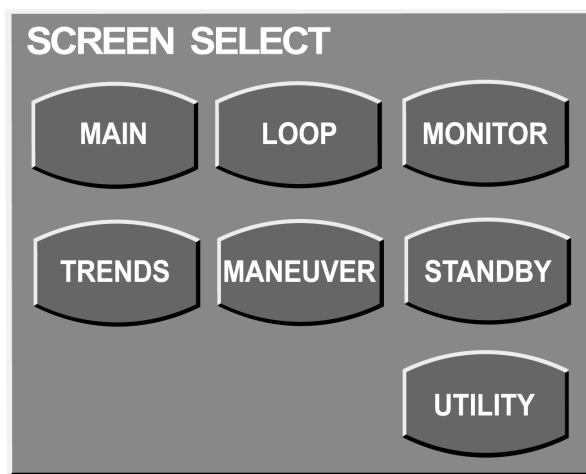

Figure 3–3: Screens Selection Box

V. Main

Returns the display to the main screen.

W. Alarm Status LEDs

The Alarm status indicators at the top right of the UIM flash red or yellow to indicate a high or medium priority alarm (see “Chapter 5: Volumetric Capnography”).

Patient Setup

Patient Select Screen

The Patient Select screen allows you to choose to resume ventilation of the current patient (RESUME CURRENT) or select (NEW PATIENT) to reconfigure ventilator settings.

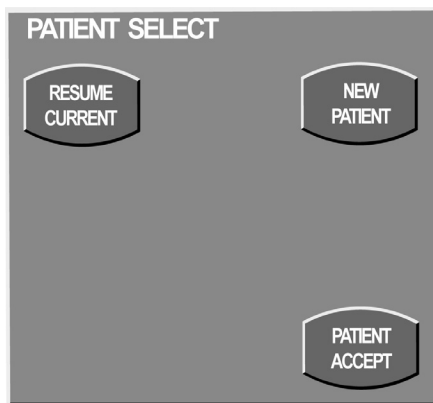

Figure 3–4: Patient Select Screen

If you press the Resume Current key, the ventilator begins ventilation at the most recent patient settings.

The New Patient key clears loops and trend buffers and **resets all settings to default values**.

Press Patient Accept to accept your selection.

Patient Size Select Screen

The Patient Size Select screen appears as the first step of the new patient setup sequence.

Note:

The new patient size selection will not be active until the on screen SETUP ACCEPT button is pressed.

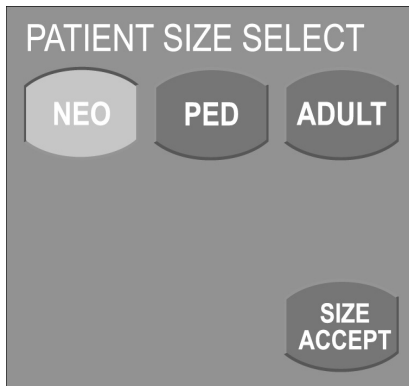

Figure 3–5: Patient Size Selection Screen

Note:

The ventilator will not allow patient size changes when the active mode of ventilation is not available in the new patient size selection. The ventilator will display a message instructing you to first change the ventilation mode. For example, in neonatal ventilation with TCPL active, you cannot change to a pediatric or adult patient size without first changing the mode to one available for those patients.

Ventilation Setup

Ventilation Setup Screen

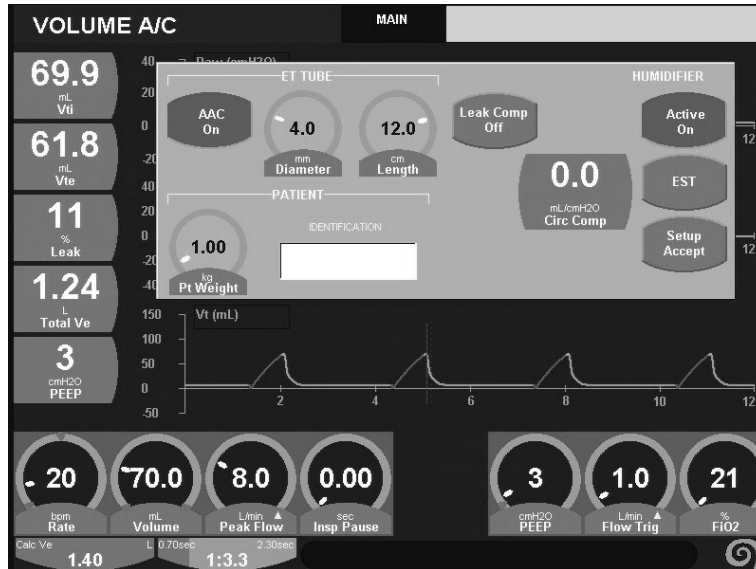

Figure 3–6: Ventilation Setup Screen

In the Setup screen, controls are available to set the following:

Artificial Airway Compensation (AAC)

Range	ON/OFF
Default:	OFF

When Artificial Airway Compensation is turned on, the ventilator automatically calculates the pressure drop across the endotracheal tube and adjusts the airway pressure to deliver the set inspiratory pressure to the distal (carina) end of the endotracheal tube. This calculation takes into account flow, gas composition (Heliox or Nitrogen/Oxygen), Fraction of Inspired Oxygen (FIO₂), tube diameter, length, and pharyngeal curvature based on patient size (Neonatal, Pediatric, Adult). This compensation only occurs during inspiration. Artificial Airway Compensation is active in all Pressure Support and Flow Cycled Pressure Control Breaths.

Note:

Monitored airway pressures (inspiratory) will be higher than set values when Artificial Airway Compensation is active.

WARNING

Activation of Artificial Airway Compensation while ventilating a patient will cause a sudden increase in the peak airway pressures and a resultant increase in tidal volume. Exercise caution when activating Artificial Airway Compensation while the patient is attached to the ventilator to minimize the risk of excessive tidal volume delivery.

Even if inspiratory pressure is set at zero, Artificial Airway Compensation will still provide an elevated airway pressure to compensate for the resistance of the endotracheal tube.

When turned on, the Artificial Airway Compensation (AAC) indicator will appear on the touch screen in *all* modes of ventilation, even though Artificial Airway Compensation may not be active in the current mode (i.e. in volume controlled breaths). This is to alert you to the fact that Artificial Airway Compensation is turned on and will become active if a Pressure Support mode or a combination mode (i.e.: Volume Control SIMV) is selected.

Tube Diameter:

Range:	2.0 to 10.0 mm	
Default:	7.5 mm	(Adult)
	5.5 mm	(Pediatric)
	3.0 mm	(Neonate)

Tube length:

Range:	2.0 to 30.0 cm	(Adult)
	2.0 to 26.0 cm	(Pediatric)
	2.0 to 15.0 cm	(Neonate)
Default:	30.0 cm	(Adult)
	26.0 cm	(Pediatric)
	15.0 cm	(Neonate)

Leak Compensation (LEAK COMP)

Range	ON/OFF.
Default:	OFF

During exhalation, PEEP is maintained by the cooperation of the Flow Control Valve (FCV) and the Exhalation Valve (ExV). The ExV pressure servo is set to a target pressure of PEEP and the FCV pressure servo is set to a pressure target of PEEP - 0.4 cmH₂O. The ExV servo relieves when the pressure is above its target and the FCV supplies flow when the pressure drops below its target up to a maximum flow rate for the patient size. It is not active during breath delivery.

Circuit Compliance

When Circuit Compliance is active, the volume of gas delivered during a volume controlled or targeted breath is increased to include the set volume plus the volume lost due to the compliance effect of the circuit.

Exhaled volume monitors, are adjusted for the compliance compensation volume in all modes of ventilation.

Range:	0.0 to 7.5 ml/cmH ₂ O
Default:	0.0 ml/cmH ₂ O

Circuit compliance is measured automatically by the ventilator during an Extended Systems Test (EST). The value cannot be entered manually.

Note:

Circuit Compliance is active for set Tidal Volume in volume control ventilation, Target Tidal Volume in PRVC and Machine Volume in Adult and Pediatric applications only. **Although circuit compliance is displayed on the set up screen it is not active for neonatal patients.**

Humidifier

You can select active or passive humidification (ON/active or OFF/passive). Active humidification assumes 99% RH; passive assumes 60% RH when using an HME. This feature adjusts the BTPS correction factor to correct exhaled tidal volumes.

Range: Active ON/OFF

Default: Active ON

Note:

Incorrect setting of the Humidification feature will affect monitored exhaled volume accuracy

Patient Weight

Patient Weight can be set in the following ranges.

Adult	1 to 300 Kg
Pediatric	1 to 75 Kg
Neonate	0.1 to 16 Kg
Default:	1 Kg

Patient weight is a variable determined by the clinician and is used for the purpose of displaying monitored volume per unit weight.

Identification

Patient ID. You may input a 24-character (two x 12-character), alphanumeric patient identification. To create a patient ID, press the Touch Screen directly over the Patient IDENTIFICATION field.

A secondary screen appears showing the characters available for patient identification. Turn the data dial at the bottom of the UIM (Figure 3–7) to scroll through the characters. Press the ACCEPT membrane key to accept each character and build your **Patient ID code**. When the Patient ID code is complete, once again press the Touch Screen directly over the Patient IDENTIFICATION field to accept the entire Patient ID code.

Check the rest of the screen parameters and if you are satisfied with the setup, press the SETUP ACCEPT button.

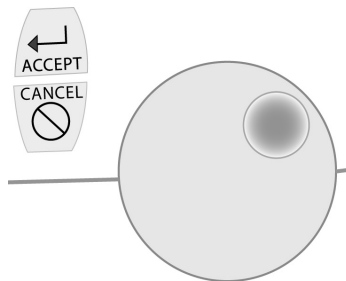

Figure 3–7: Data Dial, Accept & Cancel Button

Note:

Primary breath controls active for the selected (highlighted) mode are visible at the bottom of the touch screen during setup. The Advanced Settings dialog box and the Alarm Limits dialog box can also be opened during setup. All controls are active and may be modified while in the Set Up screen.

Note:

The setup button is disabled during the Pflex, MIP/P100 and AutoPEEP maneuvers. It is active during an Esophageal maneuver.

EST (Extended Systems Test)

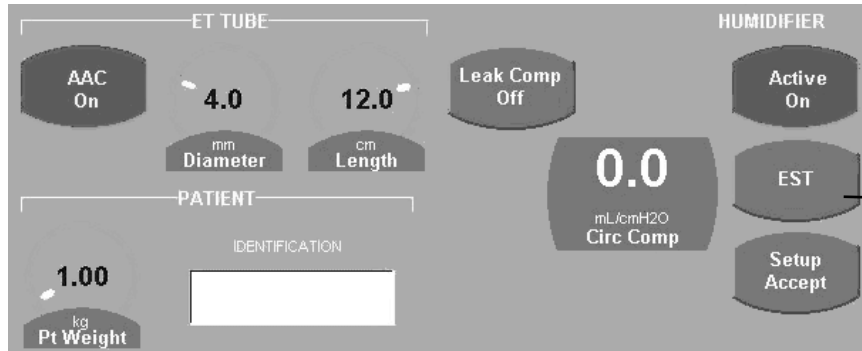

From the Setup screen, press the EST button.

Figure 3–8: Setup Screen, EST Button

A message will appear instructing you to remove the patient and block the patient wye. After confirming that the patient is disconnected and the circuit wye blocked, press Continue (Cont).

The ventilator begins the EST and displays a countdown clock. During the EST the ventilator will perform:

- A Patient circuit leak test.
- A Patient circuit compliance measurement.
- A two point calibration of the oxygen sensor

The patient circuit compliance measurement and leak test are performed simultaneously with the oxygen sensor calibration. The maximum time for the EST is 90 seconds. To restart the EST at any time, press Cancel to return to the set up screen.

After each test is complete the ventilator will display a “Passed” or “Failed” message next to the corresponding test.

The “SET UP ACCEPT” key must be pressed in order for the AVEA to retain the circuit compliance measurement. At this point, even after power cycling off, if “SAME PT” is selected, the circuit compliance measurement will continue to be retained. If “NEW PT” is selected, the EST will be required to use this feature.

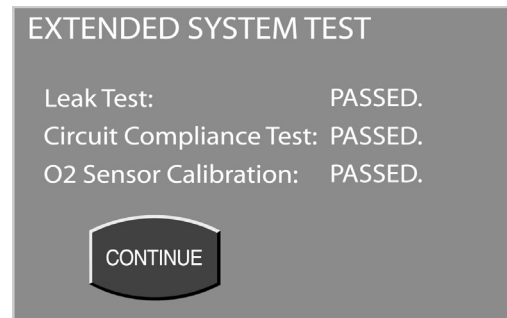
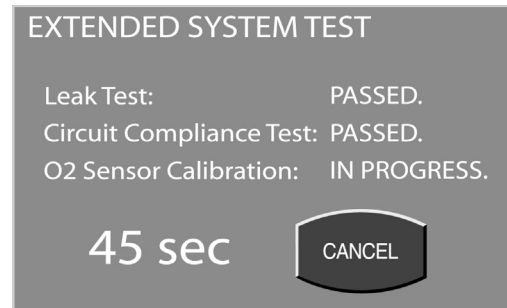

Figure 3–9: Extended Systems Test Screens

Once the test is complete, press Continue to return to the set up screen.

Note:

If the ventilator is NOT connected to an oxygen supply the O₂ Sensor Calibration will immediately fail.

CAUTION

Although failure of any of the above tests will not prevent the ventilator from functioning, it should be checked to make sure it is operating correctly before use on a patient.

Setting the Ventilation Breath Type and Mode

To access the Mode selection options, press the Mode membrane button to the left of the LCD screen.

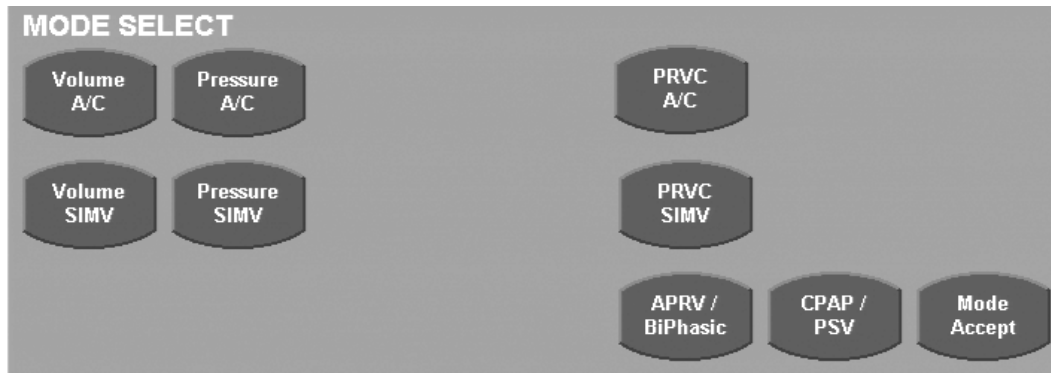

Figure 3–10: Adult and Pediatric Mode Select screen

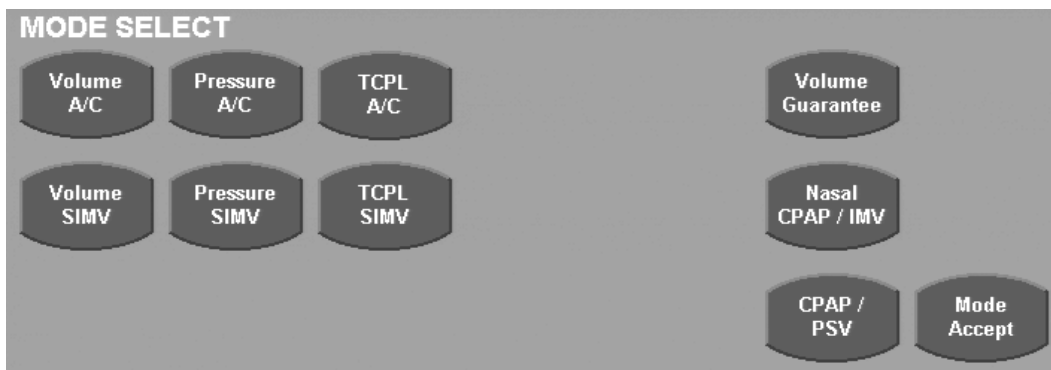

Figure 3–11: Infant Mode Select screen

The choices displayed in the Mode Select screen are a combination of breath type and ventilation delivery mode (e.g. a Volume limited breath with Assist /Control ventilation is shown as Volume A/C). APNEA Backup ventilation choices appear when CPAP/PSV or APRV / BIPHASIC mode is selected. Apnea Backup is active in all Assist Control, SIMV, APRV / BIPHASIC and CPAP/PSV modes.

Note:

When **CPAP/PSV** or **APRV / BIPHASIC** (Airway Pressure Release Ventilation) is selected, you **MUST**

1. Set the primary and advanced settings for CPAP/PSV or APRV / BIPHASIC
2. Select the breath type for APNEA backup mode by pressing the Apnea Settings key
3. Set the primary and advanced controls visible at the bottom of the touch screen, for the selected apnea breath type before pressing the MODE ACCEPT button. The controls for the apnea breath type will not be visible once the MODE ACCEPT button has been pressed. Only those controls that are active and required for CPAP/PSV or APRV / BIPHASIC will remain. To review the Apnea backup settings press the Mode button at any time and select APNEA Settings.

Volume Guarantee (VG)

The Volume Guarantee function is available for the neonatal patient size setting only in PRESSURE and TCPL ventilation modes in both the SIMV and Assist Control breath patterns. This function provides an additional operator setting for target tidal volume. The control pressure for mandatory breaths will then be adjusted by the ventilator in order to maintain the expired tidal volume close to the preset target volume.

Note:

Volume Guarantee is only available in the neonatal patient size setting and requires the use of a proximal flow sensor. Refer to the AVEA® operator's manual for specific instructions on attaching proximal flow sensors.

Breath types

Volume Guarantee breath operation is as follows:

When Volume Guarantee is selected, the control Insp Pres will become an advanced setting, the Volume setting will be displayed as a primary control, and the ventilator will deliver a test breath at the set Inspiratory Pressure setting.

The inspiratory pressure for subsequent breaths will be adjusted by the ventilator on a breath-to-breath basis. Pressure will be adjusted separately for time-triggered breaths, patient-triggered breaths, apnea backup breaths and manual breaths in order to maintain monitored expired tidal volume close to the set target.

Specific controls

Flow Cycle

The inspiratory phase of a TCPL Volume Guarantee breath will be terminated whenever the flow to the patient falls to the operator-set percentage (Flow Cycle) of the peak flow.

When Volume Guarantee is active and Flow Cycle setting is greater than 0, the monitored leak percentage is averaged over the previous 30 seconds and is added to the Flow Cycle setting (to the maximum setting for the Flow Cycle control range) to determine the threshold for patient flow.

Flow Cycle is not available in Pressure Control when Volume Guarantee is active.

Note:

Flow cycling of a breath may cause the delivered volume to be reduced. Volume guarantee will attempt to compensate by increasing delivered pressure up to 3 cmH₂O below the high inspiratory-pressure limit. The Expiratory Volume alarm will be activated if the expiratory volume falls below the alarm threshold.

Volume Limit

Volume Limit is not available for *mandatory* breaths when Volume Guarantee is active.

Machine Volume

Machine Volume is not available when Volume Guarantee is active.

Volume Target

Default: Monitored Expired Tidal Volume (if adding Volume Guarantee to the existing ventilation mode, and a breath at the current set pressure has been delivered) or 2 mL (if no previous breath at the same mode and pressure)

Resolution: 0.1 mL

Accuracy: $\pm(0.1 \text{ mL} + 10\% \text{ setting})$

Range: 2 to 300 mL (Pressure+VG modes)
2 to 100 mL (TCPL+VG)

Note:

Leaks greater than 30% may reduce the ability to achieve the desired Volume Target.

Note:

Due to the nature of the TCPL mode, delivered volume may be reduced if inspiratory time and/or flow are inadequate to achieve the Volume Target. Volume guarantee will attempt to compensate by increasing delivered pressure up to 3 cmH₂O below the high inspiratory-pressure limit. The Expiratory Volume alarm will be activated if the expiratory volume falls below the alarm threshold.

Inspiratory Pressure

In VG, inspiratory pressure is no longer a primary control. The operator set Inspiratory Pressure is an advanced control of Volume, and is used for test breaths and acts as a backup pressure setting during certain alarm conditions.

Range: 0 – 80 cmH₂O

Default: The pressure setting of the Pressure or TCPL mode used before enabling VG.

WARNING!

The Inspiratory Pressure setting in the Advanced Controls screen should be set at an appropriate level for the patient to avoid under or over delivery of tidal volume during test breaths and certain alarm conditions.

Delivered Pressure

In volume guarantee ventilation the delivered pressure is not an operator setting, it is the pressure provided by the ventilator to maintain the set volume.

Default: Inspiratory Pressure plus PEEP

Minimum: PEEP + 2 cmH₂O

Maximum: High Peak Pressure –3 cmH₂O

Note:

Breath to breath variation of delivered pressure will not be more than 3 cmH₂O between successive breaths of the same trigger type (time vs. patient triggered).

Note:

Delivered Pressure will be limited when it reaches the High Pressure Limit setting of -3 cmH₂O. When this occurs, the message *Volume Guarantee Pressure is Limited* is displayed. The Low V_{te} or Low V_e alarms may occur.

Alarms and safety systems

Wye Sensor Disconnect

An audible/visual alarm will be activated, and FLOW SENSOR ERROR will be displayed when all of the following are true: 1) neonatal flow sensor is in use; 2) volume guarantee function is enabled; and 3) monitored V_{ti} drops below 20% of the net delivered volume. In this case, the system will revert to the operator set Inspiratory Pressure.

Alarm delay: 3 breaths, or 10s if greater, or 30s if less

Alarm priority: Medium

WARNING!

Disconnecting the proximal flow sensor or a Flow Sensor Error condition while Volume Guarantee is active will cause the ventilator to deliver pressure ventilation at the set Inspiratory Pressure.

Low P_{peak}

Range: 1 to 80 cmH₂O

Default: 5 cmH₂O

High P_{peak}

Range: 10 to 85 cmH₂O

Default: 30 cmH₂O

Low Expired Volume

An audible/visual alarm will be activated, and LOW Vte will be indicated whenever volume guarantee is active, and monitored expiratory tidal volume is less than the set threshold from the volume target.

Volume threshold: 90% of Volume target

Alarm delay: 30s or 10 breaths (whichever is greater)

Alarm priority: Medium

Limit volume

All VG breaths will be cycled by volume if inspired volume exceeds a threshold based on the set Volume Target and the leak (expressed as fraction), averaged over the previous 30 seconds.

The Volume Limit calculation varies with the degree of leak:

Mean Leak < 63%: Volume limit = (Volume Target x 1.3) x ((1.1 x Leak)+1)

Mean Leak >= 63%: Volume limit = Volume Target x 2.2

Alarm activation

During activation of the following alarms, delivered breaths are suspended and the VG control algorithm will be inactive. Once the alarm condition is resolved, the VG control algorithm will reset, and test breaths will be delivered at the operator set Inspiratory Pressure.

Circuit Disconnect

Safety Valve Open

Vent INOP

The VG control algorithm will reset to the operator set Inspiratory Pressure during the following alarm conditions and will restart the VG control algorithm when the alarm condition is resolved.

Low Ppeak

Low PEEP

Flow sensor error

The VG control algorithm will be suspended if a Circuit Occlusion alarm is active. Once the condition is resolved, the VG control algorithm will restart at the operator set Inspiratory Pressure.

Note:

Low Tidal Volume, High Tidal Volume and Low Vte Alarm Sensitivity settings are not applicable when Volume Guarantee is active.

Initiating Volume Guarantee

1. To initiate Volume Guarantee select the Modes membrane button on the UIM or touch the screen area for the Current Mode Display. The Mode Select box appears

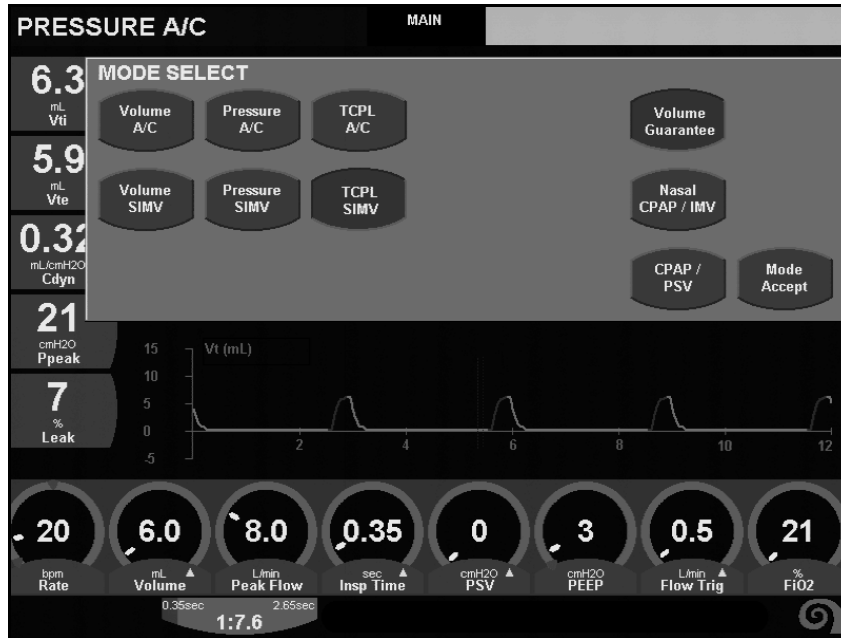

2. Select the desired mode (TCPL or Pressure) and also select Volume Guarantee.

Note:

Once Volume Guarantee is selected the Inspiratory Pressure primary control will automatically move to the Advanced Settings window and the Volume primary control will appear in its place.

The current Monitored Expired Tidal Volume will be the default setting for Volume, if adding Volume Guarantee to existing ventilation mode, and a breath at current set pressure has been delivered. In the absence of a previous breath at the current inspiratory pressure setting, the default Volume will be 2mL.

3. Set the available controls to the prescribed settings and select Mode Accept

WARNING!

The Inspiratory Pressure setting in the Advanced Controls window should be set at an appropriate level for the patient to avoid under or over delivery of tidal volume during test breaths or flow sensor disconnect.

WARNING!

Disconnecting the proximal flow sensor or removing it from the circuit while Volume Guarantee is active will cause the ventilator to deliver pressure ventilation at the set Inspiratory Pressure.

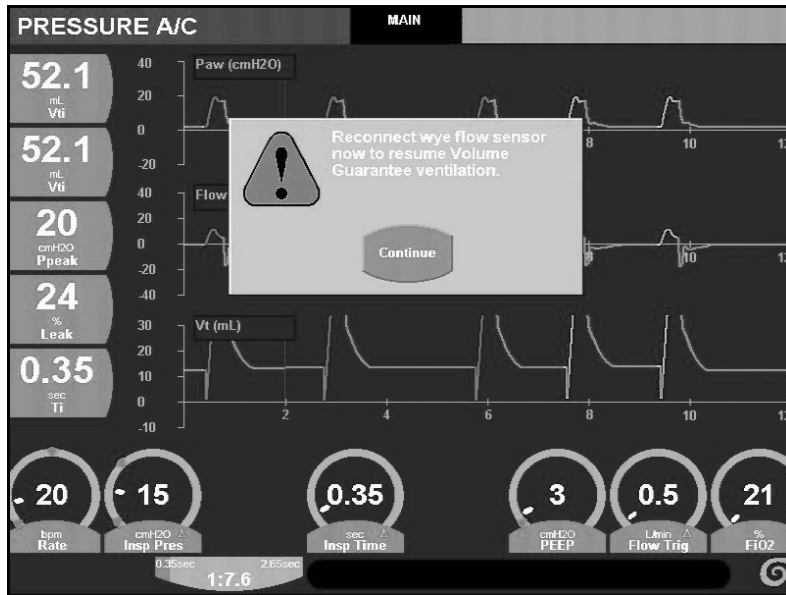

Note:

Leaks greater than 99% will cause the VTe to display ***. Under this condition, the VG algorithm will not adjust pressure, and ventilation will continue at the previous level.

Messages

AVEA® message bar text	Cause
"Volume Guarantee Disabled"	On disconnect of proximal flow sensor when Volume Guarantee is active, AAC inactive, if flow sensor not reattached prior to alert box closing.
"Volume Guarantee is only available in PRESSURE and TCPL modes"	Selection of Volume Guarantee on the mode screen when the primary mode selected is not PRESSURE or TCPL. Selection of a mode not PRESSURE or TCPL when Volume Guarantee is already enabled.
"Set Vol Target will increase delivered press and vol"	Volume Target set more than 20% above current setting.
"Set Vol Target will decrease delivered press and vol"	Volume Target set more than 20% below current setting.
"High Ppeak Limit < PEEP + 7 cmH ₂ O"	When Nasal CPAP / IMV mode is active and breath rate is not 'OFF', attempt to set High Ppeak alarm limit or nCPAP setting such that High Ppeak alarm limit setting is less than nCPAP +2 cmH ₂ O.
"Volume Guarantee pressure is limited"	The pressure required to deliver the desired tidal volume is greater than the High Ppeak alarm limit of -3 cmH ₂ O.

Troubleshooting

Alarm	Priority	Possible causes	Actions
LOW Vte	Medium	Inspiratory time or flow inadequate in TCPL	Increase inspiratory time and/or flow
		Inspiratory time too short due to flow cycling in TCPL.	Increase flow cycle setting
		Delivered Pressure has increased to its upper limit—high pressure limit of $-3 \text{ cmH}_2\text{O}$ ($\pm 2 \text{ cmH}_2\text{O}$)—due to changes in ventilator settings, resistance and/or compliance.	Increase high pressure limit or check patient condition

Breath Types

This section contains a brief description of the breath types and ventilation mode combinations available for adult, pediatric and neonatal patients.

There are two basic breath types:

- **Mandatory** breaths (delivered according to set ventilator parameters)
- and
- **Demand** breaths (triggered by the patient)

All breaths are defined by four variables:

- **Trigger** (initiates the breath),
- **Control** (controls the delivery),
- **Cycle** (primary breath termination), and
- **Limit** (secondary breath termination).

Mandatory Breaths

Mandatory breaths can be triggered by the machine, the patient, or the operator. There are 4 mandatory breath types delivered by the AVEA.

1. Volume breaths, which are:

- Controlled by flow (inspiratory);
- Limited by pre-set volume or maximum inspiratory pressure.
- Cycled by volume, flow, and time.

Note:

The Volume Controlled breath is the default breath type for adult and pediatric patients.

The Intra-Breath Demand System in Volume Ventilation

AVEA features a unique intra-breath demand system in Volume Controlled ventilation, designed to provide additional flow to the patient during periods of demand. AVEA measures the Peak Inspiratory Pressure (P_{peak}) every 2 milliseconds throughout the breath cycle and sets a "virtual" Pressure Support Target of the greater of: PEEP + 2 cmH₂O or P_{peak} – 2 cmH₂O.

The minimum "virtual" Pressure Support level is set PEEP + 2 cmH₂O.

The maximum is 2 times the set PEEP.

Simultaneously, the ventilator monitors and compares the P_{peak} measurement to its previous value. Should the P_{peak} decrease by the 2 cmH₂O, the ventilator will recognize the patient demand and automatically "switch over" to deliver a Pressure Support breath at the virtual Pressure Support Target. This allows flow to exceed the set Peak Flow, thereby meeting the patient's demand.

Once the set tidal volume has been delivered, the ventilator "looks" at the inspiratory flow. If the Peak Inspiratory Flow is greater than set peak flow, the ventilator determines that the patient is continuing to demand flow and cycles the breath when inspiratory flow falls to 25% of peak inspiratory flow. If the Peak inspiratory Flow is equal to the set flow, the ventilator determines that there is no continued patient demand and ends the breath as a Volume Control breath.

Default is on. Can be turned off by accessing advanced setting of Peak Flow in Volume Controlled Ventilation.

2. Pressure breaths, which are:

- Controlled by pressure (inspiratory + PEEP);
- Limited by pressure (inspiratory + PEEP + margin);
- Cycled by time or flow.

3. Time Cycled Pressure Limited (TCPL) breaths (available for neonatal patients only), which are:

- Controlled by inspiratory flow;
- Limited by pressure (inspiratory + PEEP);
- Cycled by time, flow (inspiratory), or volume (Volume Limit).

Note:

TCPL breath type is only available for Neonates. This is the default breath type for neonate patients.

Note:

The ventilator will not allow the operator to set a Peak Inspiratory Pressure (Insp Pres or PSV + PEEP, or baseline pressure in APRV / BiPhasic, greater than 90 cmH₂O). The ventilator will deliver an on screen Pop-Up Message stating that the P_{peak} > 90 cmH₂O. The operator must change the Inspiratory Pressure and or PEEP setting to limit the P_{peak} to less than or equal to 90 cmH₂O.

WARNING

Total resistance of the inspiratory and expiratory limbs of the breathing circuit with accessories should not exceed 4cmH₂O at 5 L/min if inspiratory flows \geq 15 liters per minute are used in TCPL ventilation modes. For instructions on how to perform a circuit resistance test (see "Appendix E: Sensor Specifications & Circuit Resistance").

4. Pressure Regulated Volume Control (PRVC) breaths are pressure breaths where the pressure level is automatically modulated to achieve a preset volume. PRVC breaths are:

- Controlled by pressure (inspiratory + PEEP) and volume;
- Limited by pressure (inspiratory + PEEP + margin);
- Cycled by time or flow.

PRVC breath operation is as follows:

- When PRVC is selected, a decelerating flow, volume controlled test breath, to the set tidal volume with a 40 msec pause, is delivered to the patient. The demand system is active during this test breath.
- The ventilator sets the target pressure at the *end inspiratory pressure* of the test breath for the first pressure control breath.
- The next breath and all subsequent breaths are delivered as pressure control breaths. The inspiratory pressure is based on the dynamic compliance of the previous breath and the set tidal volume.

Inspiratory pressure is adjusted automatically by the ventilator to maintain the target volume. The maximum step change between two consecutive breaths is 3 cmH₂O. The maximum tidal volume delivered in a single breath is determined by the Volume Limit setting.

The test breath sequence is initiated when any of the following occur:

- Entering the Mode (PRVC)
- Changing the set tidal volume while in PRVC
- Reaching the Volume Limit setting
- Delivered tidal volume ≥ 1.5 times the set volume
- Flow termination of the test breath
- Exiting Standby
- Activation of any of the following alarms

High Peak Pressure Alarm
Low Peak Pressure Alarm
Low PEEP Alarm
Patient Circuit Disconnect Alarm
I-Time Limit
I:E Limit

Note:

If flow cycling is active during a PRVC or Vsync breath flow cycling of the breath can only occur **if** the target tidal volume has been delivered. This allows for expiratory synchrony while assuring delivered tidal volume.

Note:

Demand Flow is active for all mandatory breaths. The maximum peak inspiratory pressure achievable by the ventilator is limited by the high peak pressure alarm setting.

Demand Breaths

All demand breaths are patient-triggered, controlled by pressure, and flow or time cycled. Demand breaths can be either pressure supported (PSV) or spontaneous. All demand breaths are accompanied by the yellow patient demand indicator, which flashes in the upper left of the screen.

1. PSV (Pressure Support Ventilation)

A PSV breath is a demand breath in which the pressure level during inspiration is a preset PSV level plus PEEP. The minimum pressure support level is PEEP + 2 cmH₂O in adult and pediatric applications, independent of the set PSV pressure level. In neonatal applications the minimum pressure support level is zero.

PSV breaths are:

- Controlled by pressure (preset PSV level + PEEP);
- Limited by pressure (preset PSV level + PEEP)
- Cycled by time (PSV T_{max}) or flow (PSV Cycle).

Pressure Support is active when CPAP/PSV, SIMV or APRV/BiPhasic modes are selected

Note:

The ventilator will not allow the operator to set a Peak Inspiratory Pressure (Insp Pres or PSV + PEEP, or baseline pressure in APRV / BiPhasic, greater than 90 cmH₂O). The ventilator will deliver an on screen Pop-Up Message stating that the P_{peak} > 90 cmH₂O. The operator must change the Inspiratory Pressure and or PEEP setting to limit the P_{peak} to less than or equal to 90 cmH₂O.

2. Spontaneous breath

In adult and pediatric applications, a Spontaneous breath is a demand breath where the pressure level during inspiration is preset at PEEP + 2 cmH₂O.

In neonatal applications a Spontaneous breath is a demand breath delivered only at the preset PEEP.

Note:

IF PSV level is insufficient to meet patient demand, premature termination of the breath may occur with auto-triggering. In these cases the PSV level should be increased slightly.

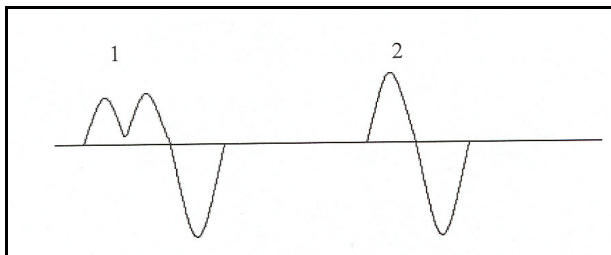

Figure 3–12: PSV Waveform

In Figure 3–12 breath number 1 represents the flow tracing which occurs when the PSV level is insufficient to meet the patient demand. Breath two shows resolution after increasing the PSV level slightly. (Pressure tracing will show a similar appearance).

Ventilation Modes

Leak Compensation.

The ventilator incorporates a leak compensation system. This system compensates for baseline leaks at the patient - interface. To activate leak compensation, use the touch screen control displayed in the Setup screen.

Assist Control Ventilation (A/C)

This is the default mode for all patient types. In Assist Control ventilation mode, *all* breaths initiated and delivered are mandatory breaths. The initiation of a breath is triggered by one of the following:

- Patient effort activates the inspiratory trigger mechanism,
- The breath interval, as set by the RATE control, times out,
- The operator presses the MANUAL BREATH key.

Initiation of a breath by any means resets the breath interval timing mechanism. It is possible for the patient to initiate every breath if he/she is breathing faster than the preset breath rate. If the patient is *not* actively breathing, the ventilator automatically delivers breaths at the preset interval (set breath rate).

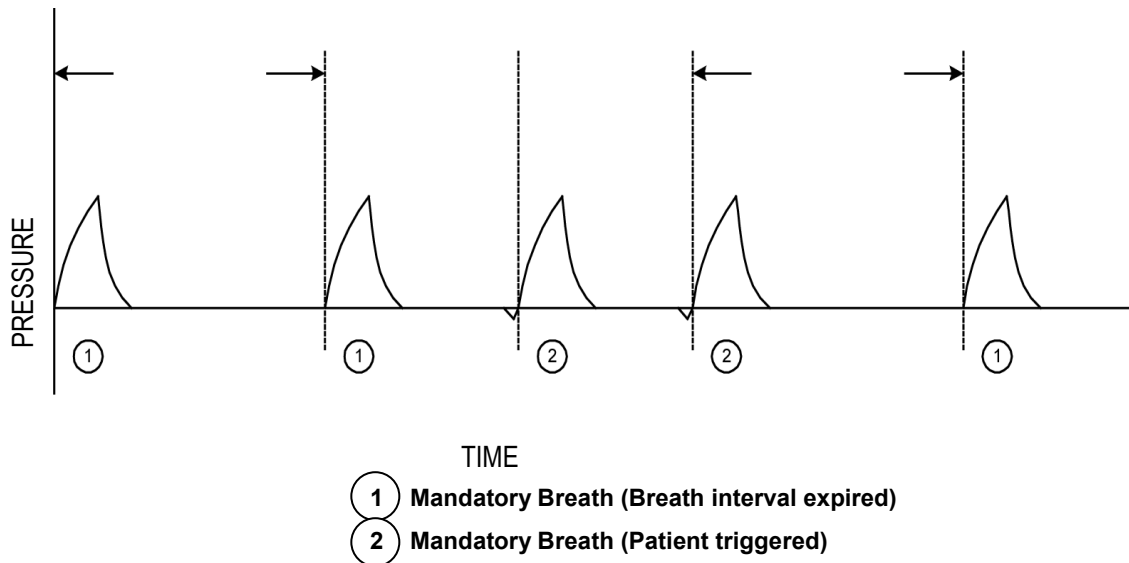

Figure 3-13: Assist Control Ventilation Waveform

Synchronized Intermittent Mandatory Ventilation (SIMV)

In SIMV mode, the ventilator can deliver both mandatory and demand breath types. Mandatory breaths are delivered when the SIMV “time window” is open and one of the following occurs:

- A patient effort is detected;
- The breath interval has elapsed with no patient effort detected;
- The MANUAL BREATH key has been pressed.

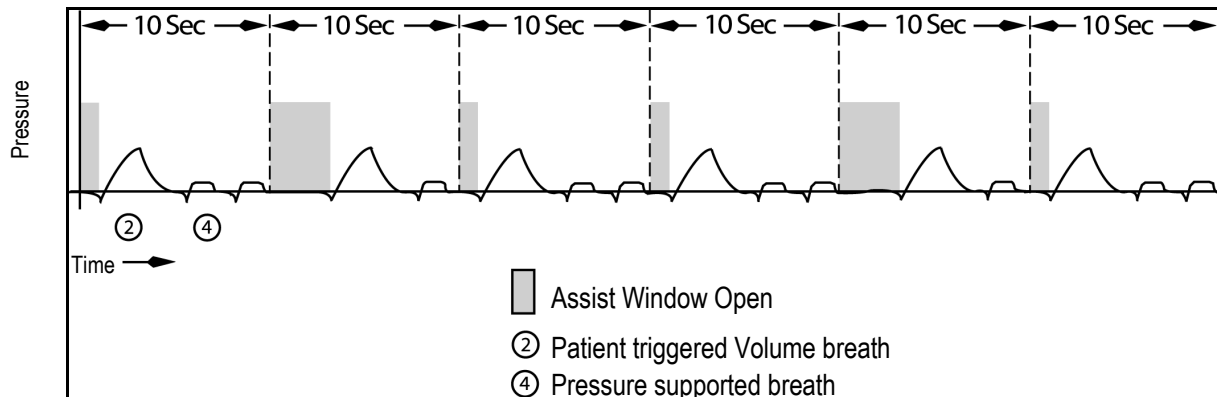

Figure 3–14: SIMV Waveform

The breath interval is established by the preset breath rate. It resets as soon as the interval time determined by the set breath rate has elapsed, or when the MANUAL BREATH key is pressed.

Airway Pressure Release Ventilation (APRV / BIPHASIC)

APRV / BiPhasic is a Time Cycled Pressure mode in which the ventilator cycles between two different baseline pressures based on time, which can be synchronized with patient effort. Controlled ventilation can be maintained by timed cycling the transitions between baseline pressures. Additionally, pressure support can be added to improve comfort for the spontaneous breathing patient.

In this mode, the patient is allowed to breathe spontaneously at two preset pressure levels. These are set using the **Pres High** and **Pres Low** controls. The *maximum* duration at each pressure during time cycling is set with the **Time High** and **Time Low** controls.

The operator can also adjust the length of the respective trigger (Sync) windows with the Time High and Time Low Sync controls, which are advanced settings of Time High and Time Low. The Sync windows are adjustable from 0 to 50%, in 5% increments of set Time High and Time Low.

The ventilator synchronizes the change from Pressure Low to Pressure High with the detection of inspiratory flow **or** the first inspiratory effort detected within the T Low Sync window. Transition from Pressure High to Pressure Low occurs with the first **end of inspiration** detected after the T High Sync window opens.

Note:

Time High and Time Low are **maximum** time settings for a time-cycled transition. Actual times may vary depending on the patient's spontaneous breathing pattern and the Sync window setting.

Setting the Sync to 0% cycles the transition between pressure levels on time only and will not provide synchronization with patient efforts.

The Manual Breath button is not active in APRV / BiPhasic.

The monitored PEEP in APRV/BIPHASIC is relative to the breath type. In the absence of spontaneous breathing, the monitored PEEP will be the Pressure Low. In the presence of spontaneous breathing the monitored PEEP will reflect the baseline pressure over which spontaneous breathing is occurred.

Adjustable PSV in APRV / BiPhasic

APRV / BiPhasic features adjustable PSV. The PSV is delivered above the current phase baseline pressure. PSV breaths are available during Time High also, by activating T High PSV (an advanced setting of Time High). If T High PSV is activated, during Time High, the ventilator will deliver the same PSV level for both Pressure Low and Pressure High.

Note:

The ventilator will not allow the operator to set a Peak Inspiratory Pressure (Insp Pres or PSV + PEEP, or baseline pressure in APRV / BiPhasic, greater than 90 cmH₂O). The ventilator will deliver an on screen Pop-Up Message stating that the P_{peak} > 90 cmH₂O. The operator must change the Inspiratory Pressure and or PEEP setting to limit the P_{peak} to less than or equal to 90 cmH₂O. This 90 cmH₂O limit warning is not active when T High PSV is OFF.

Apnea Ventilation in APRV / BiPhasic

Apnea ventilation is available in APRV / BiPhasic. If the patient does not initiate a spontaneous effort, or the ventilator does not time cycle between pressure levels before the apnea interval has elapsed, the ventilator will alarm for apnea and begin apnea ventilation at the apnea ventilation settings. A spontaneous effort from the patient or a transition in baseline pressure will reset the apnea alarm and timer and return the ventilator to APRV / BiPhasic ventilation.

Airway Pressure Release Ventilation (APRV / BIPHASIC)

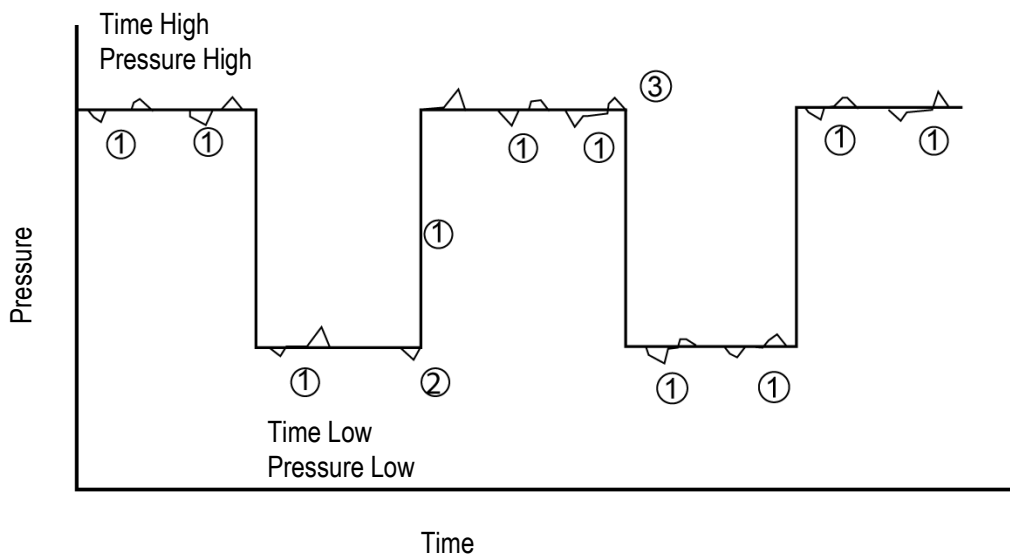

- ① = Demand Breath
- ② = Spontaneous Breath triggers change to Pressure High
- ③ = Spontaneous Breath triggers change to Pressure Low

Figure 3–15: APRV / BIPHASIC Mode

Continuous Positive Airway Pressure (CPAP) Pressure Support Ventilation (PSV)

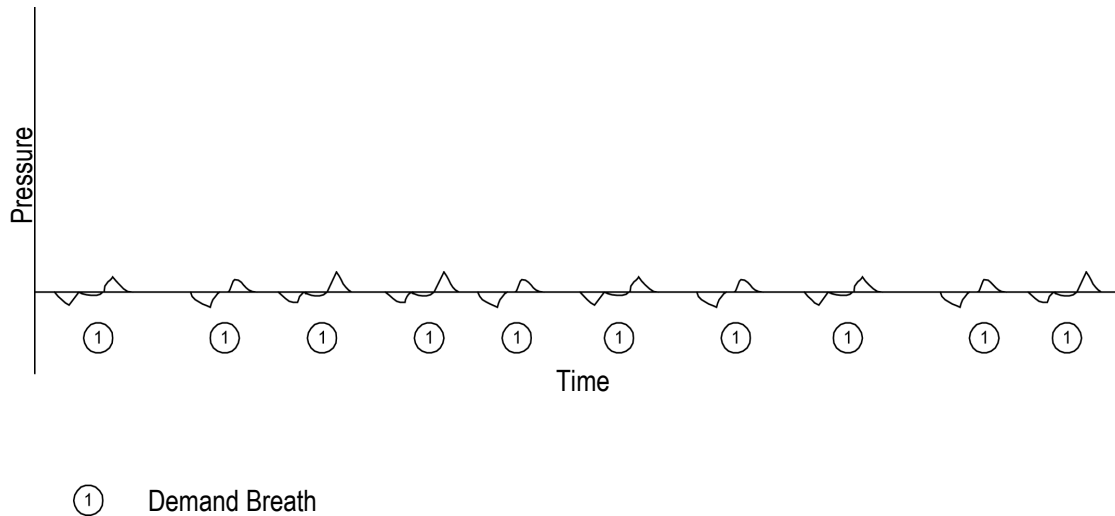

Figure 3–16: CPAP Waveform

In CPAP/PSV mode, all breaths are patient-initiated demand breaths unless the MANUAL BREATH key is pressed or apnea backup ventilation is activated. When the MANUAL BREATH key is pressed, a single breath is delivered at the currently selected apnea backup control settings.

Pressure Support is active in CPAP mode (see “Demand Breaths” on page 76).

CAUTION

When CPAP/PSV is selected, you must

1. Select the breath type for APNEA backup mode **AND**
2. Set the primary controls visible at the bottom of the touch screen, for the selected apnea breath type before pressing the MODE ACCEPT button. **The controls for the apnea breath type will not be visible once the MODE ACCEPT button has been pressed.** Only those controls that are active and required for CPAP/PSV will remain. To review the settings for Apnea backup ventilation open the mode window, and select Apnea Settings

Note:

IF PSV level is insufficient to meet patient demand, premature termination of the breath may occur with auto-triggering. In these cases the PSV level should be increased slightly.

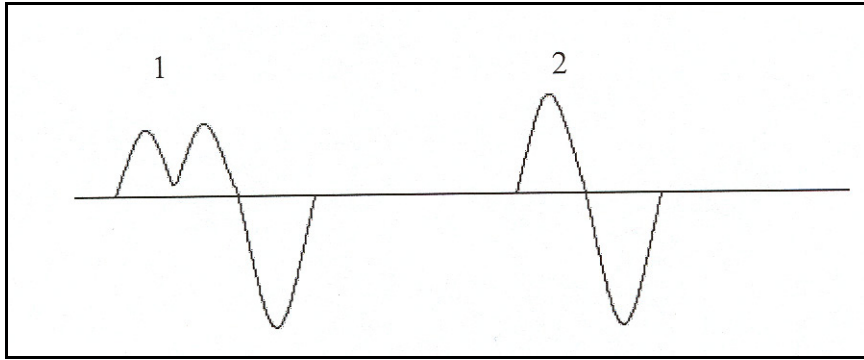

Figure 3–17: PSV Waveform

In Figure 3–17 breath number 1 represents the flow tracing which occurs when the PSV level is insufficient to meet the patient demand. Breath two shows resolution after increasing the PSV level slightly. (Pressure tracing will show a similar appearance).

Non-Invasive Ventilation

The ventilator can perform non-invasive ventilation with a standard dual limb circuit. Leak compensation should be turned on when using this feature. To turn leak compensation on, use the touch screen control displayed in the Ventilator Set-Up Screen. See Chapter 6 for Infant Non-invasive ventilation.

Note:

Non invasive ventilation requires the use of a snug fitting mask with no bleed holes. Excessive leaks around the mask may result in false triggering of the ventilator or assertion of disconnect alarms.

Apnea Backup Ventilation

Apnea Backup Ventilation is available in Assist Control, SIMV, CPAP/PSV and APRV / BIPHASIC modes.

Apnea Backup in Assist Control or SIMV

When in Assist Control or SIMV modes, the apnea backup rate is determined by the operator-set mandatory breath Rate or the Apnea Interval setting (whichever provides the highest respiratory rate).

When the Apnea Interval setting (found in the Alarm Limits window) determines the backup rate, the ventilator will continue to ventilate at this rate until the apnea has been resolved.

All other controls for apnea ventilation in Assist Control and SIMV are set when the primary control values for these modes are selected.

Apnea ventilation will terminate when one of the following criteria are met:

- The patient initiates a spontaneous breath
- A manual breath is delivered
- The mandatory respiratory rate is increased above the apnea interval setting.

Note:

The apnea interval timer is suspended during a Patient Circuit Disconnect Alarm.

Apnea Backup in CPAP/PSV or APRV / BIPHASIC

When CPAP/PSV or APRV / BIPHASIC is selected, you MUST:

1. Set the primary and advanced settings for CPAP/PSV or APRV / BIPHASIC.
2. Select the breath type for APNEA backup mode (Volume or Pressure in adult and pediatric patients or Volume, Pressure or TCPL in neonatal patients) by pressing the Apnea Settings key.
3. Set the primary and advanced controls appearing at the bottom of the touch screen, for the selected apnea breath type *before* pressing the MODE ACCEPT button. **The controls for apnea backup ventilation will not be visible once the MODE ACCEPT button has been pressed. Only the controls that are active and required for CPAP/PSV or APRV / BIPHASIC will remain.**

See Figure 3–18 to Figure 3–21 for Apnea backup settings available in each mode.

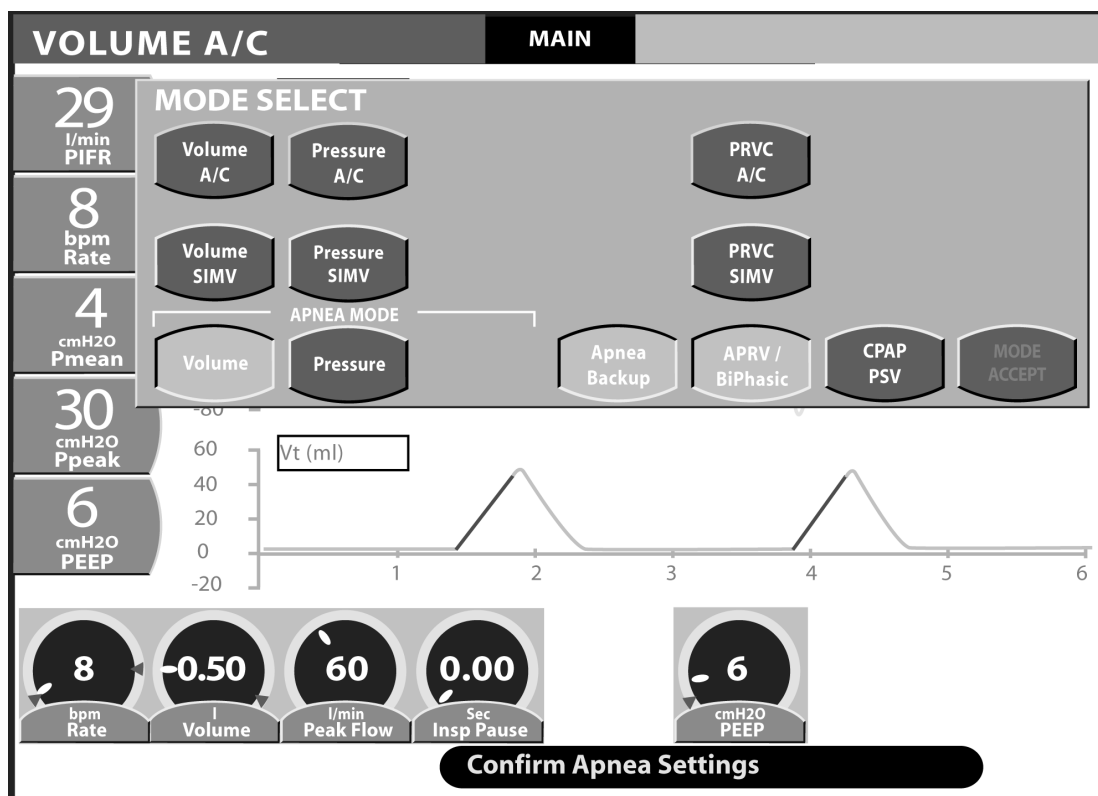

Figure 3–18: Volume Apnea Backup settings for APRV / BIPHASIC Mode

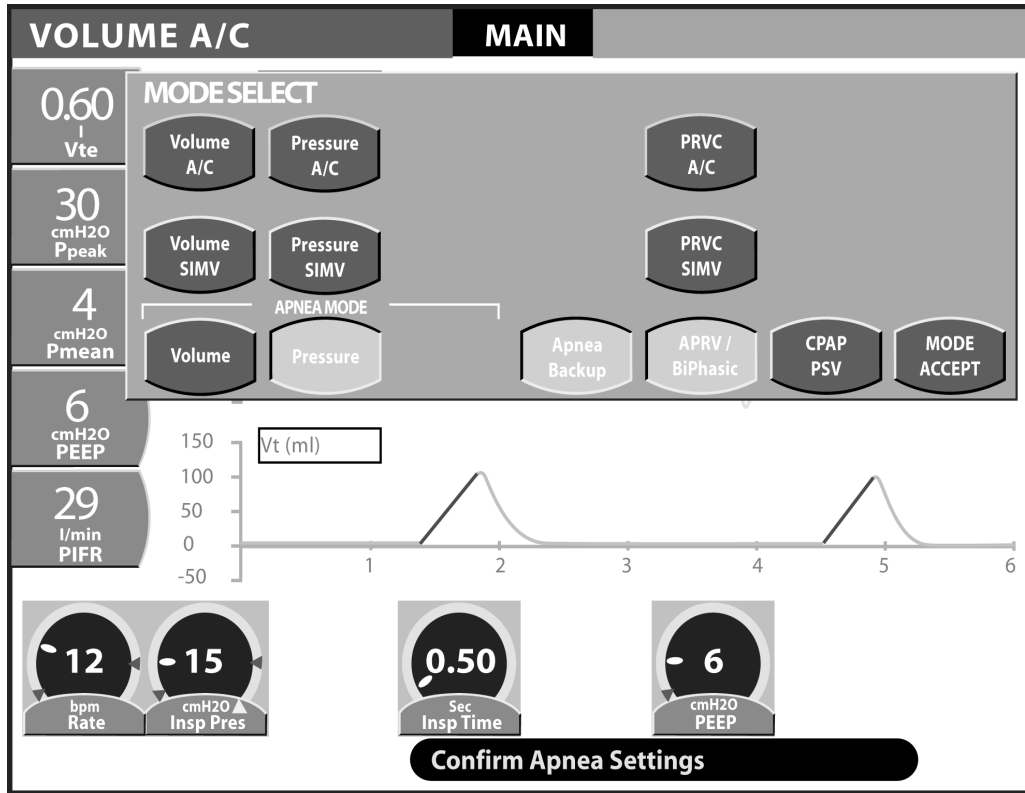

Figure 3–19: Pressure Apnea Backup settings for APRV / BIPHASIC Mode

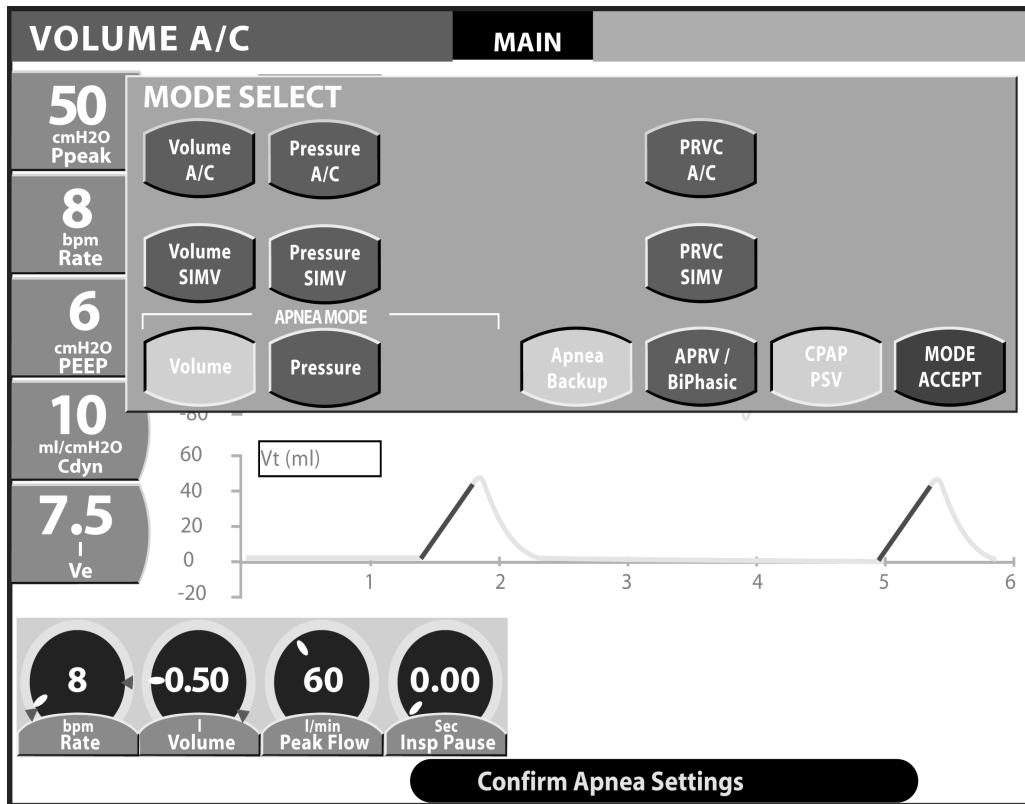

Figure 3–20: Volume Apnea Backup settings for CPAP Mode

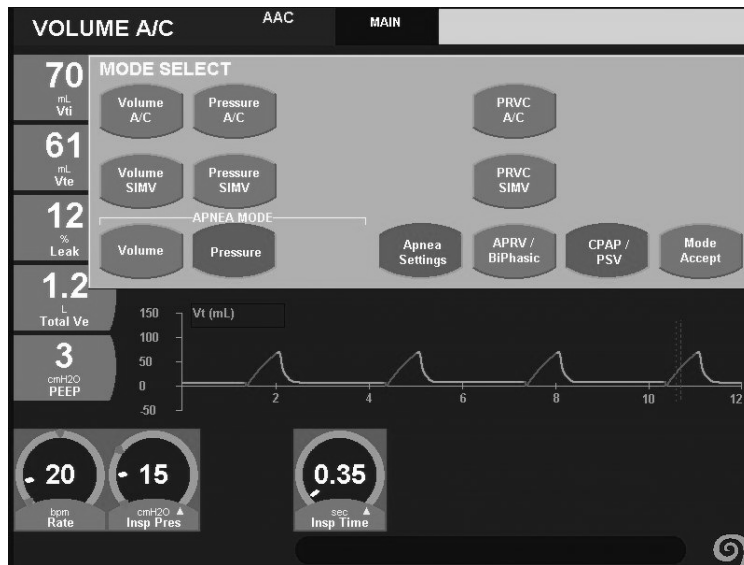

Figure 3–21: Pressure Apnea Backup settings for CPAP Mode

Apnea ventilation will terminate when one of the following criteria are met:

- The patient initiates a spontaneous breath
- A manual breath is delivered
- A timed transition between baseline pressures in APRV / BiPhasic

To review the Apnea backup settings press the Mode button at any time and select APNEA Settings.

Note:

When changing from a controlled mode of ventilation to CPAP/PSV or APRV / BIPHASIC, the default apnea settings will be the same as those set in the controlled mode. If a New Patient is selected, the default apnea settings are the same as the factory set default settings for each of the controlled modes.

Note:

The current set FIO₂ is delivered during Apnea ventilation.

Standby

To initiate Standby, press the Screens membrane button on the UIM identified by the icons shown here.



or



International

English

The Screen Select box appears (Figure 3–22).

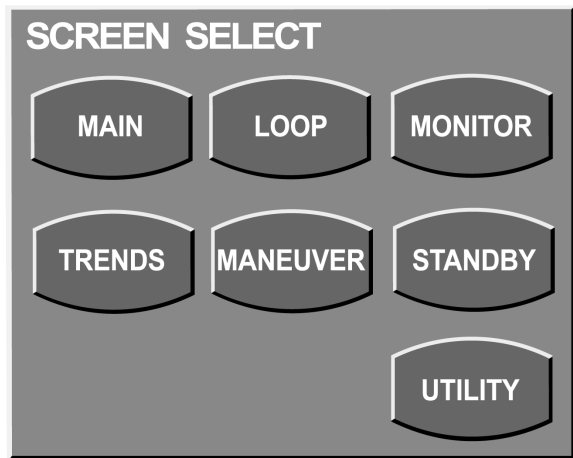

Figure 3–22: Screen Select

Press STANDBY. The following message will display

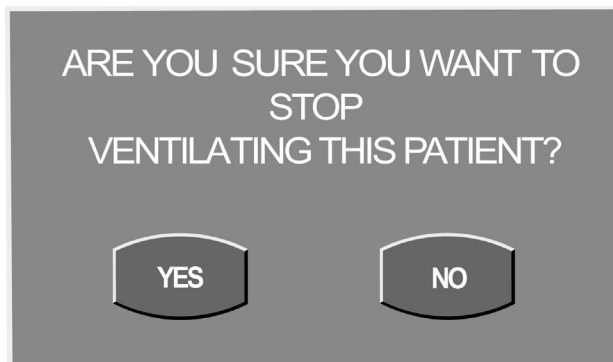

Figure 3–23: Standby Message

If you select "YES", the ventilator will stop ventilating, the safety valve will close and the ventilator will supply 2 L/min of gas continuously to the patient circuit and will display the message shown in Figure 3–24.



Figure 3–24: Standby Screen

To resume patient ventilation, press the Resume button. The ventilator will restart ventilation at the most recent settings. Do not re-connect the patient to the ventilator until the RESUME button has been pressed and ventilation has restarted.

CAUTION

The 2 liters of bias flow, which is maintained during standby, is intended to reduce the risk of circuit overheating in the event an active humidifier is in use and left on.

To ensure flow through the entire ventilator circuit, the patient wye should be plugged to direct flow down the expiratory limb of the circuit. Failure to do this may result in damage to the ventilator circuit if the humidifier is left on. Consult the circuit manufacturer to confirm that 2 L/min of flow is sufficient to prevent overheating.

Note:

Some alarms such as Loss A/C, Loss of O₂, Loss of Air, Loss of Gas will be active in Standby.

Available Breath Types & Modes by Patient Size

Adult and Pediatric Ventilation Modes

The following breath types & ventilation modes are available for Adult and Pediatric patients. When a mode is selected, its description is displayed at the top left of the touch screen.

Table 3–1: Adult and Pediatric Displayed Modes

Displayed Mode	Description
Volume A/C	Volume breath with Assist ventilation (Default for adult and pediatric patients)
Pressure A/C	Pressure breath with Assist ventilation
Volume SIMV	Volume breath with Synchronized Intermittent Mandatory Ventilation (SIMV) and an adjustable level of pressure support for spontaneous breaths.
Pressure SIMV	Pressure Breath with Synchronized Intermittent Mandatory Ventilation (SIMV) and an adjustable level of pressure support for spontaneous breaths.
CPAP / PSV	Continuous Positive Airway Pressure (Demand Breath) with Pressure Support Ventilation
PRVC A/C	Pressure Regulated Volume Controlled breath with Assist Ventilation
PRVC SIMV	Pressure Regulated Volume Controlled breath with Synchronized Intermittent Mandatory Ventilation (SIMV) and an adjustable level of pressure support for spontaneous breaths.
APRV / BIPHASIC	Spontaneous demand breath at two alternating baseline pressure levels or controlled ventilation cycled by time.

Neonatal Ventilation Modes

The following table shows the breath types and ventilation modes available for Neonatal patients

Table 3–2: Neonatal Displayed Modes

Displayed Mode	Description
Volume A/C	Volume breath with Assist ventilation (Default for adult and pediatric patients).
Pressure A/C	Pressure breath with Assist ventilation.
Volume SIMV	Volume breath with Synchronized Intermittent Mandatory Ventilation (SIMV) and an adjustable level of pressure support for spontaneous breaths.
Pressure SIMV	Pressure Breath with Synchronized Intermittent Mandatory Ventilation (SIMV) and an adjustable level of pressure support for spontaneous breaths.
TCPL A/C	Time Cycled Pressure Limited breath with Assist ventilation (Default for neonatal patients).
TCPL SIMV	Time Cycled Pressure Limited breath with SIMV and an adjustable level of pressure support for spontaneous breaths.
CPAP / PSV	Continuous Positive Airway Pressure (Demand Breath) with Pressure Support Ventilation.
Nasal CPAP / IMV	Continuous Positive Airway Pressure (Demand Breath) with or without Intermittent Mandatory Ventilation.
Pressure A/C + VG	Pressure Breaths with Assist ventilation (Assist Control) with an adjustable volume target (Volume Guarantee).
Pressure SIMV + VG	Pressure Breaths with Synchronized Intermittent Mandatory Ventilation (SIMV) and an adjustable volume target.
Pressure TCPL + VG	Pressure Breaths with Synchronized Intermittent Mandatory Ventilation (SIMV) and an adjustable volume target.

Primary Breath Controls

The Primary Breath Controls are the operator set controls, which directly affect the way a breath is delivered to your patient. They are displayed along the bottom of the AVEA LCD touch screen. *Only the active controls for the selected mode of ventilation will be displayed.*

Table 3–3: Primary Breath Controls

Displayed Control	Description	Range	Accuracy
bpm Rate	Breath rate shown in Breaths per Minute	1 to 150 bpm (Neo / Pediatric) 1 to 120 bpm (Adult)	± 1 bpm
ml Volume	Tidal Volume in milliliters	0.10 to 2.50 L (Adult) 25 to 500 ml (Pediatric) 2.0 to 300 ml (Neonate)	± (0.2 ml + 10% of setting)
cmH ₂ O Insp Pres	Inspiratory Pressure in centimeters of water pressure	0 to 90 cmH ₂ O (Adult/Pediatric) 0 to 80 cmH ₂ O (Neonate)	Adult/Pediatric: ±4cmH ₂ O +5% Neonate: ±3 cmH ₂ O +2.5% (measured at the patient wye, end inspiratory pressure after 0.3 seconds)
L/min Peak Flow	Peak Inspiratory Flow in Liters per Minute	3 to 150 L/min (Adult) 1 to 75 L/min (Pediatric) 0.4 to 30.0 L/min (Neonate)	± 10% of setting or ± (0.2 L/min + 10% of setting), whichever is greater
sec Insp Time	Inspiratory Time in Seconds	0.20 to 5.00 sec (Adult/Pediatric) 0.15 to 3.00 sec (Neonate)	± 0.10 sec
sec Insp Pause	Sets an inspiratory pause which will be in effect for each Volume breath delivered	0.0 to 3.0 sec	± 0.10 sec
cmH ₂ O PSV	Pressure Support in centimeters of water pressure	0 to 90 cmH ₂ O (Adult/Pediatric) 0 to 80 cmH ₂ O (Neonate)	± 3 cmH ₂ O or ± 10% whichever is greater
cmH ₂ O PEEP	Positive end expiratory pressure in centimeters of water pressure	0 to 50 cmH ₂ O	± 2 cmH ₂ O or ± 5% of setting, whichever is greater
L/min Flow Trig	Sets inspiratory flow trigger point in liters per minute	0.1 to 20.0 L/min	+ 1.0 / – 2.0 L/min (for PEEP ≤ 30 cmH ₂ O) + 2.0 / – 3.0 L/min (for PEEP > 30 cmH ₂ O) ± (0.2 L/min + 10% of setting) (Wye flow sensor only)
% %O₂	Controls the percentage of oxygen in the delivered gas.	21% to 100%	± 3% O ₂
cmH ₂ O Pres High	In APRV / BIPHASIC mode, controls the baseline pressure achieved during Time High.	0 to 90 cm H ₂ O	± 3 cmH ₂ O
sec Time High	In APRV / BIPHASIC mode sets the minimum time for which the high-pressure setting is maintained.	0.20 to 30.0 sec	± 0.1 sec
sec Time Low	In APRV / BIPHASIC mode sets the minimum time for which the low pressure setting is maintained.	0.20 to 30.0 sec	± 0.1 sec
cmH ₂ O Pres Low	In APRV / BIPHASIC mode controls the baseline pressure achieved during Time Low.	0 to 45 cmH ₂ O	± 2 cmH ₂ O or ± 5% of setting, whichever is greater

To activate a primary control, press the touch screen directly over the control. The control highlights (changes color) indicating that it is active.

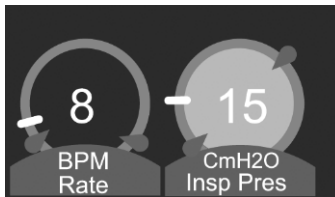

Figure 3–25: Highlighted Control

To modify the settings for the highlighted control, turn the data dial below the touch screen (Figure 3–26). Turning in a clockwise direction increases the selected value, turning counterclockwise decreases it.

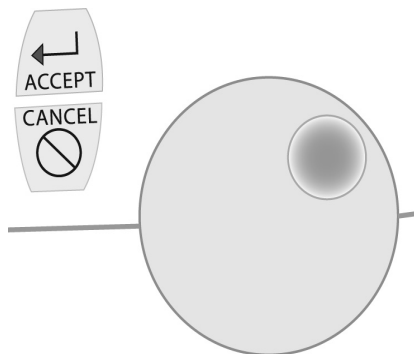

Figure 3–26: Data dial.

To accept the displayed value, either press the touch screen directly over the highlighted control or press the ACCEPT membrane button to the left of the data dial. The control color will change back to normal and the ventilator will begin operating with the new setting. If you press the CANCEL button or do not actively accept the new setting within 15 seconds, ventilation will continue at the previous settings.

Descriptions of Primary Breath Controls

Breath Rate (Rate)

The breath rate control sets the breath interval. Its function is dependent upon the selected mode of ventilation and it has different effects on the breath cycle, depending on which mode is selected.

Range:	1 to 150 bpm (Neonate / Pediatric)
	1 to 120 bpm (Adult)
Breath Interval:	(60/Rate) sec.
Defaults:	12 bpm (Adult)
	12 bpm (Pediatric)
	20 bpm (Neonate)

Tidal Volume (Volume)

A volume breath delivers a predetermined volume of gas to the patient. Tidal Volume, together with the Insp Flow, and Waveform settings determine how the volume breath is delivered.

Range:	0.10 to 2.50 L (Adult)
	25 to 500 ml (Pediatric)
	2.0 to 300 ml (Neonate)
Defaults:	0.50 L (Adult)
	100 ml (Pediatric)
	2.0 ml (Neonate)
Sigh:	1.5 x Volume (Adult/Pediatric only)

Note:

When operated from the internal compressor, the maximum Tidal Volume that the ventilator can achieve is 2.0 L. The maximum minute volume that the ventilator is capable of delivering using wall gas supply is at least 60L and using internal compressor is 40L.

Inspiratory Pressure (Insp Pres)

During a mandatory pressure breath, the ventilator controls the inspiratory pressure in the circuit. For Pressure & TCPL breaths, the pressure achieved is a combination of the preset Insp. Pres. level plus PEEP.

Range:	0 to 90 cmH ₂ O (Adult/Pediatric)
	0 to 80 cmH ₂ O (Neonate)
Maximum Flow:	> 200 L/min (Adult)
	≤ 120 L/min (Pediatric)
	≤ 50 L/min (Neonate)
Default:	15 cmH ₂ O

Note:

The ventilator will not allow the operator to set a Peak Inspiratory Pressure (Insp Pres or PSV + PEEP, or baseline pressure in APRV / BiPhasic, greater than 90 cmH₂O). The ventilator will deliver an on screen Pop-Up Message stating that the P_{peak} > 90 cmH₂O. The operator must change the Inspiratory Pressure and or PEEP setting to limit the P_{peak} to less than or equal to 90 cmH₂O.

Peak Flow

Peak flow is the flow delivered by the ventilator during the inspiratory phase of a mandatory volume or TCPL breath.

Range:	3 to 150 L/min	(Adult)
	1 to 75 L/min	(Pediatric)
	0.4 to 30.0 L/min	(Neonate)
Defaults:	60 L/min	(Adult)
	20 L/min	(Pediatric)
	8.0 L/min	(Neonate)

Inspiratory Time (I-Time)

The I-Time control sets the inspiratory time cycle variable for all mandatory pressure, TCPL or PRVC breaths.

Range:	0.20 to 5.00 seconds	(Adult/Pediatric)
	0.15 to 3.00 seconds	(Neonate)
Default:	1.0 second	(Adult)
	0.75 seconds	(Pediatric)
	0.35 second	(Neonate)

Note:

If the preset I-Time is greater than actual I-Time (as determined by V_t , F_P , and the waveform), an Inspiratory Pause time equal to the preset I-Time minus the actual I-Time is added to the breath.

Inspiratory Pause (Insp Pause)

Sets an Inspiratory Pause, which will be in effect for each volume breath delivered.

A preset inspiratory pause will be delivered with each volume breath.

Range:	0.00 to 3.00 seconds
Default:	0.00 second

PSV (Pressure Support)

The PSV control sets the pressure in the circuit during a pressure supported breath.

Range:	0 to 90 cmH ₂ O	(Adult/Pediatric)
	0 to 80 cmH ₂ O	(Neonate)
Maximum Flow:	> 200 L/min	(Adult)
	≤ 120 L/min	(Pediatric)
	≤ 50 L/min	(Neonate)
Default:	0 cmH ₂ O	

Note:

The ventilator will not allow the operator to set a Peak Inspiratory Pressure (Insp Pres or PSV + PEEP, or baseline pressure in APRV / BiPhasic, greater than 90 cmH₂O). The ventilator will deliver an on screen Pop-Up Message stating that the Ppeak > 90 cmH₂O. The operator must change the Inspiratory Pressure and or PEEP setting to limit the Ppeak to less than or equal to 90 cmH₂O.

Note:

In adult and pediatric ventilation, a minimum of 2 cmH₂O of PSV above PEEP is applied even when the control is set to zero.

Note:

IF PSV level is insufficient to meet patient demand, premature termination of the breath may occur with auto-triggering. In these cases the PSV level should be increased slightly.

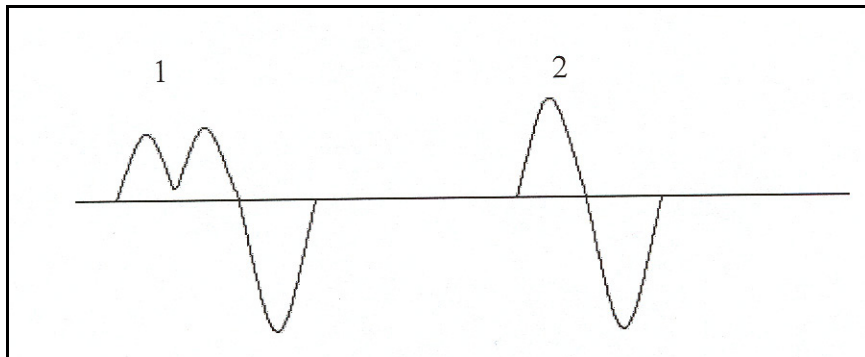

Figure 3–27: PSV Waveform

In Figure 3–27 breath number 1 represents the flow tracing which occurs when the PSV level is insufficient to meet the patient demand. Breath two shows resolution after increasing the PSV level slightly. (Pressure tracing will show a similar appearance).

Note:

Monitored airway pressures (inspiratory) will be higher than set when AAC is active. With an inspiratory pressure setting of zero, AAC will still provide an elevated airway pressure, to compensate for the resistance of the endotracheal tube.

Positive End Expiratory Pressure (PEEP)

PEEP is the pressure that is maintained in the patient circuit at the end of exhalation.

Range:	0 to 50 cmH ₂ O	
Defaults:	6 cmH ₂ O	(Adult/Pediatric)
	3 cmH ₂ O	(Neonate)

Note:

The ventilator will not allow the operator to set a Peak Inspiratory Pressure (Insp Pres or PSV + PEEP, or baseline pressure in APRV / BiPhasic, greater than 90 cmH₂O). The ventilator will deliver an on screen Pop-Up Message stating that the P_{peak} > 90 cmH₂O. The operator must change the Inspiratory Pressure and or PEEP setting to limit the P_{peak} to less than or equal to 90 cmH₂O.

Note:

The ventilator may assert a circuit occlusion alarm in conditions when measured PEEP is significantly greater than operator set PEEP.

Inspiratory Flow Trigger (Flow Trig)

The inspiratory trigger mechanism* is activated when the Net Flow becomes greater than the Inspiratory Flow Trigger setting. Net Flow is defined as [Delivered Flow – Exhaled Flow] (or Wye Inspiratory Flow when using a wye flow sensor). When the Inspiratory Flow Trigger is enabled, a low level of Bias Flow is delivered to the patient circuit during the exhalation phase of the breath.

Range: 0.1 to 20.0 L/min

Defaults: 1.0 L/min (Adult/Pediatric)
0.5 L/min (Neonate)

*See also "Pres Trig" on 101.

CAUTION

If a proximal flow sensor is used it must be attached at both the patient wye and at the ventilator connection to ensure proper function of the AVEA.

Note:

To ensure adequate bias flow for inspiratory triggering the bias flow setting should be at least 0.5 liters per minute greater than the flow trigger threshold.

%O₂

The % O₂ control sets the percentage of oxygen in the delivered gas.

Range: 21 to 100%

Default: 40%

Note:

During Heliox administration the %O₂ control sets the percent of Oxygen in the delivered gas. The balance of the delivered gas is Helium.

Pressure High (Pres High)

This control is only available in APRV / BIPHASIC Mode. It controls the baseline pressure achieved during Time High.

Range: 0 to 90 cmH₂O

Default: 15 cmH₂O

Time High

Available in APRV / BIPHASIC mode only, this control sets the maximum time for which the Pressure High setting is maintained.

Range: 0.2 to 30 seconds

Default: 4 seconds

Time Low

In APRV / BIPHASIC mode, this control sets the maximum time for which the Pressure Low setting is maintained.

Range: 0.2 to 30 seconds

Default: 2 second

Pressure Low

In APRV / BIPHASIC Mode, this control sets the baseline pressure achieved during Time Low.

Range: 0 to 45 cmH₂O

Default: 6 cmH₂O

Advanced Settings

When the mode and the primary breath controls have been set, you can further refine delivery of the breath by accessing the Advanced Settings.

Accessing the Advanced Settings

To access the advanced settings group, press the ADV SETTINGS membrane button located to the left of the touch screen between the Mode and the Set-up buttons. The LED indicator on the button illuminates and the Advanced Settings screen appears. When you select a primary control by pressing and highlighting the control at the bottom of the touch screen, the available advanced settings for that selected control appear in the advanced settings screen.

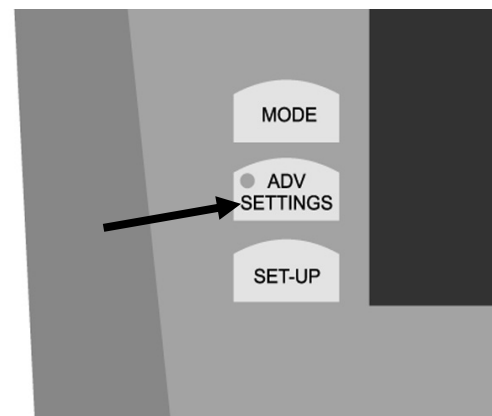

Figure 3–28: Advanced Settings membrane button

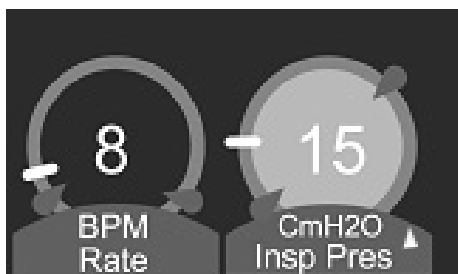

Figure 3–29: Advanced Settings indicator

Primary Controls, which feature an advanced setting, will display a yellow triangle to the right of the control name.

Note:

Not every primary control will have an associated advanced setting.

Table 3–4: Controls and Advanced Settings Associated with Breath Type & Mode

BREATH TYPE & MODE	VOL A/C	VOL SIMV	PRES A/C	PRES SIMV	PRVC A/C	PRVC SIMV	CPAP/PSV	APRV / BIPHASIC	TCPL A/C	TCPL SIMV
PRIMARY CONTROLS										
RATE bpm	*	*	*	*	*	*	* Apnea Mode	* Apnea Mode	*	*
VOLUME ml	*	*			*	*	* Apnea Mode	* Apnea Mode		
INSP PRES cmH ₂ O			*	*			* Apnea Mode	* Apnea Mode	*	*
PEAK FLOW L/min	*	*					* Apnea Mode	* Apnea Mode	*	*
INSP TIME sec			*	*	*	*	* Apnea Mode	* Apnea Mode	*	*
INSP PAUSE sec	*	*					* Apnea Mode	* Apnea Mode		
PSV cmH ₂ O		*		*		*	*	*		*
PEEP cmH ₂ O	*	*	*	*	*	*	*	*	*	*
FLOW TRIG L/min	*	*	*	*	*	*	*	*	*	*
% OXYGEN %O ₂	*	*	*	*	*	*	*	*	*	*
PRES HIGH cmH ₂ O								*		
TIME HIGH sec								*		
TIME LOW sec								*		
PRES LOW cmH ₂ O								*		
ADVANCED SETTINGS AVAILABLE WITHIN EACH MODE	Vsync*, Vsync rise*, Sigh,** Waveform, Bias flow, Pres trig Vol limit (when Vsync = ON), Flow Cycle*, Demand Flow	Vsync*, Vsync rise*, Sigh,** Waveform, Vol. Limit, PSV rise, PSV cycle, PSV Tmax, Bias flow, Pres trig, Flow Cycle*, Demand Flow	Mach vol, Vol limit, Insp rise, Flow cycle, Bias flow, Pres trig	Mach vol, Vol limit, Insp rise, Flow cycle, PSV rise, PSV cycle, PSV Tmax, Bias flow, Pres trig	Insp rise, Bias flow, Pres trig Vol Limit, Flow Cycle	Vol limit, PSV rise, PSV cycle, PSV Tmax, Bias flow, Pres trig, Flow Cycle	Vol limit, PSV rise, PSV cycle, PSV Tmax, Bias flow, Pres trig	Vol limit, PSV rise, PSV cycle, PSV Tmax, Bias flow, Pres trig T High Sync T High PSV T Low Sync	Vol limit, Flow cycle, Bias flow, Pres trig	Vol limit, Flow cycle, PSV rise, PSV cycle, PSV Tmax, Bias flow, Pres trig

* Available only with Vsync activated for adult or pediatric patients only.

** Available for adult and pediatric patients only.

Advanced Settings Characteristics and Ranges

Volume Limit (Vol Limit)

The Vol Limit setting sets the volume limit for a Pressure Limited breath. When the volume delivered to the patient meets or exceeds the preset Vol Limit, the inspiratory phase of the breath is terminated.

Range:

Normal:	0.10 to 2.50 L	(Adult)
	25 to 750 ml	(Pediatric)
	2.0 to 300.0 ml	(Neonate)
Defaults:	2.50 L	(Adult)
	500 ml	(Pediatric)
	300 ml	(Neonate)

The Vol Limit setting sets the volume limit for a Pressure limited breath. When the volume delivered to the patient meets or exceeds the preset Vol Limit, the inspiratory phase of the breath is terminated.

Volume Limit is active for Pressure, PRVC / Vsync, TCPL, and PSV breaths only. In neonatal applications Volume Limit requires the use of a wye flow sensor. Whenever a proximal flow sensor is used (Neonatal, Pediatric or Adult applications) the Volume Limit is activated by the inspiratory tidal volume measured by the wye flow sensor. In adult and pediatric applications where no wye flow sensor is used Volume Limit is determined by the calculated inspiratory wye flow. When the volume limit threshold has been reached the ventilator alarm status indicator will change to yellow and display the words Volume Limit. The alarm status indicator cannot be reset until the ventilator has delivered a breath, which does not meet the volume limit threshold. To reset the alarm status window use the alarm-reset button.

CAUTION

If a proximal flow sensor is used it must be attached at both the patient wye and at the ventilator connection to ensure proper function of the AVEA.

Note:

Excessive inspiratory flow rates or highly compliant ventilator circuits may allow delivery of a tidal volume that exceeds the volume limit setting. This is due to the ventilator circuit recoiling and providing additional tidal volume to the patient. Delivered tidal volumes should be closely monitored to ensure Volume Limit accuracy.

Machine Volume (Mach Vol)



The Machine Volume control sets the minimum tidal volume delivered **from the ventilator** when the control is activated in a pressure control breath. This control is always used with the time cycling criterion in pressure control ventilation. Machine volume is circuit compliance compensated in adult and pediatric applications.

Range:

Normal:	0.10 to 2.50 L	(Adult)
	25 to 500 ml	(Pediatric)
	2.0 to 300.0 ml	(Neonate)

Defaults:	0 L	(Adult)
	0 ml	(Pediatric)
	0 ml	(Neonate)

Once you set the machine volume, the ventilator calculates the decelerating inspiratory flow required to deliver the Machine Volume in the set inspiratory time. When a Pressure Control breath is delivered and Peak Flow decelerates to this calculated peak inspiratory flow, if the Machine Volume has not been met the ventilator will automatically transition to a continuous flow until the Machine Volume has been delivered. Once the set Machine Volume has been delivered the ventilator will cycle into exhalation. When the Machine Volume is met or exceeded during delivery of the pressure control breath, the ventilator will complete the breath as a normal Pressure Control breath.

During this transition in flow, the Inspiratory Time will remain constant and the Peak Inspiratory Pressure will increase to reach the set Machine Volume. The maximum Peak Inspiratory Pressure is determined by the High Peak Pressure alarm setting.

Note:

Pmax is disabled when Machine Volume is set. In the event Flow Cycling is active in Pressure Control the ventilator will not Flow Cycle until the Machine Volume has been met. Machine Volume must be set to zero to change patient size.

To set Machine Volume in adult and pediatric applications (with circuit compliance compensation active) simply set the minimum desired tidal volume.

In neonatal applications with proximal flow sensor in use:

- Adjust the peak inspiratory pressure to reach the desired tidal volume.
- Select Vdel as one of the monitored parameters. Read the Vdel (uncorrected Tidal Volume delivered from the machine) during a pressure control breath.
- Set the Machine volume to or slightly below the Vdel measurement. This will set the machine volume to a level that will provide more consistent tidal volume delivery in the case of slight decreases in lung compliance.

CAUTION

If a proximal flow sensor is used it must be attached at both the patient wye and at the ventilator connection to ensure proper function of the AVEA.

Note:

To protect against larger changes in lung compliance, the machine volume should be set higher and Volume Limit should be added.

Insp Rise

The Inspiratory Rise setting controls the slope of the pressure rise during a mandatory breath. This control is a relative control with fast being a setting of 1, and slow a setting of 9.

Range: 1 to 9

Default: 5

The Inspiratory Rise control is not active for TCPL breaths.

Flow Cycle

The flow cycle setting sets the percentage of the peak inspiratory flow (Peak Flow), at which the inspiratory phase of a Pressure Control, TCPL or PRVC/Vsync breath is terminated.

Range: 0 (Off) to 45%

Default: 0% (Off)

Flow cycling is active for Pressure, PRVC/Vsync or TCPL breaths only.

Note:

If flow cycling is active during a PRVC or Vsync breath flow cycling of the breath can only occur **if** the target tidal volume has been delivered. This allows for expiratory synchrony while assuring delivered tidal volume.

Note:

If Flow Cycling is active during a pressure control breath, monitored airway pressures (inspiratory) will be higher than set when AAC is active. In pediatric and adult ventilation with an inspiratory pressure setting of zero AAC will still provide an elevated airway pressure, which will compensate for the resistance of the endotracheal tube.

Waveform

During the delivery of a volume breath, flow can be delivered in one of two user selectable waveforms: square wave or decelerating wave. The default waveform is Decelerating Wave.

Square Wave (Sq)

With this waveform selected, the ventilator delivers gas at the set peak flow for the duration of the inspiration.

Decelerating Wave (Dec)

With this waveform selected, the ventilator delivers gas starting at the peak flow and decreasing until the flow reaches 50% of the set peak flow.

Demand Flow

Enables and disables the Intra-Breath Demand system in volume controlled ventilation. The default position is on.

Note:

Should the patient's inspiratory demand be sustained beyond the controlled inspiratory time plus the minimum expiratory time **with the demand system turned off**, auto-triggering or double triggering may occur. This is the result of the patient demanding more flow than available resulting in a breath trigger after the minimum expiratory time. This may be resolved by increasing the inspiratory flow rate to meet the patients demand or turning the demand system back on.

Sigh

The ventilator delivers sigh volume breaths when this setting is ON. A sigh volume breath is delivered every 100th breath in place of the next normal volume breath.

Range:	Off, On (every 100 breaths)
Sigh Volume:	1.5 times set tidal volume
Sigh Breath Interval (sec):	Set Normal Breath Interval x 2 (Assist mode) <u>or</u> set Normal Breath Interval (SIMV mode)
Default:	Off

Sigh breaths are only available for Volume breaths in Assist and SIMV modes for adult and pediatric patients.

Bias Flow

The Bias Flow control sets the background flow available between breaths. Additionally, this control establishes the base flow that is used for flow triggering.

Range:	0.4 to 5.0 L/min
Defaults:	2.0 L/min

Note:

To ensure adequate bias flow for inspiratory triggering the bias flow setting should be at least 0.5 liters per minute greater than the flow trigger threshold. Consult the ventilator circuit manufacturer to ensure that bias flow setting is sufficient to prevent overheating of the ventilator circuit.

Pres Trig

Sets the level below PEEP at which the inspiratory trigger mechanism is activated. When the pressure in the patient circuit falls below PEEP by the set pressure trigger level, the ventilator will cycle to inspiration.

Range:	0.1 to 20.0 cmH ₂ O
Default:	3.0 cmH ₂ O

Vsync

Vsync breaths are:

- Controlled by pressure (inspiratory + PEEP) and volume;
- Limited by pressure (inspiratory + PEEP + margin);
- Cycled by time. Inspiratory time in Vsync is determined indirectly by setting the peak inspiratory flow. The set inspiratory time is displayed in the message bar.

Vsync breath operation is as follows:

When Vsync is selected, a decelerating flow, volume test breath to the set tidal volume with a 40 msec pause is delivered to the patient. The ventilator sets the target pressure at the end inspiratory pressure of the test breath or the first pressure control breath. The next breath and all subsequent breaths are delivered as pressure control breaths. Inspiratory pressure is adjusted automatically, based on the dynamic compliance of the previous breath, to maintain the target volume. The maximum step change between two consecutive breaths is 3 cmH₂O. The maximum tidal volume delivered in a single breath is determined by the Volume Limit setting.

This test breath sequence is initiated when any of the following occur:

- Entering the Mode (Vsync)
- Changing the set tidal volume while in Vsync
- Reaching the Volume Limit setting
- Delivered tidal volume ≥ 1.5 times the set volume
- Flow termination of the test breath
- Exiting Standby
- Activation of any of the following alarms
 - High Peak Pressure Alarm
 - Low Peak Alarm
 - Low PEEP Alarm
 - Patient Circuit Disconnect Alarm
 - I-Time Limit
 - I:E Limit

Vsync is only available for adult and pediatric patients.

Note:

If flow cycling is active during a PRVC or Vsync breath flow cycling of the breath can only occur **if** the target tidal volume has been delivered. This allows for expiratory synchrony while assuring delivered tidal volume.

Note:

The Peak Flow control sets the flow rate, which is used by the ventilator for the test breath only. The ventilator uses the Peak Flow setting and Inspiratory Pause to determine the maximum inspiratory time during Vsync ventilation.

Vsync Rise

With Vsync active, this control sets the slope of the pressure rise during the volume breath. It is a relative control ranging from fast (1) to slow (9).

Range:	1 to 9
Default:	5

PSV Rise

This control sets the slope of the pressure rise during a pressure-supported breath. It is a relative control with a range from fast (1) to slow (9).

Range:	1 to 9
Default:	5

PSV Cycle

Sets the percentage of peak inspiratory flow at which the inspiratory phase of a PSV breath is terminated.

Range:	5 to 45%
Default:	25% (Adult/Pediatric) 10% (Neonate)

PSV Tmax

Controls the maximum inspiratory time of a pressure-supported breath.

Range:	0.20 to 5.00 seconds (Adult/Pediatric) 0.15 to 3.00 (Neonate)
Default:	5.00 seconds (Adult) 0.75 seconds (Pediatric) 0.35 seconds (Neonate)

T High Sync

T High Sync establishes the length of respective trigger (Sync) window while in Time High. Transition from Pressure High to Pressure Low occurs with the first end of inspiration detected after the T High Sync window opens.

Range:	0-50% in 5% increments of set T High.
Default:	Adult and Pediatric: 0%
Infant:	Not Applicable

T High PSV

Pressure Support breaths are available during Time High in APRV / BiPhasic by activating T High PSV. If T High PSV is activated, during Time High, the ventilator will deliver the same PSV level for both Pressure Low and Pressure High.

Range (Pressure Support):	Adult and Pediatric 0-90 CcmH ₂ O
Infant:	Not Applicable
Not to exceed a PIP > 90 cmH ₂ O.	
Default:	Adult and Pediatric: Off Infant: Not Applicable

T Low Sync

T Low Sync establishes the length of respective trigger (Sync) window while in Time Low. The ventilator synchronizes the change from Pressure Low to Pressure High with the detection of inspiratory flow or the first inspiratory effort detected within the T Low Sync window.

Range:	0-50% in 5% increments of set T Low.
Default:	Adult and Pediatric: 0%
Infant:	Not Applicable

Note:

PSV Rise, PSV Cycle and PSV Tmax are active even if the PSV level is set to Zero

Independent Lung Ventilation (ILV)

Independent lung ventilation allows 2 ventilators to be synchronized to the same breath rate (the rate control set on the master ventilator), while all other primary and advanced controls for each ventilator can be set independently. Master and slave ventilators need not operate in the same mode during ILV.

The AVEA offers a port to allow Independent Lung Ventilation (ILV). This connection is located on the rear panel (, C). The output provides a 5 VDC logic signal, synchronized to the breath phase of the master ventilator.

A specially configured accessory cable kit (part number 16246), available from CareFusion, is required to implement ILV.

WARNING

Do NOT attempt to connect a standard DB-25 cable to this receptacle. This could cause damage to the ventilator. A specially configured cable is required for ALL features associated with this connector. Contact Technical Support.

To enable Independent Lung Ventilation, refer to Chapter 2, Ventilator Setup, Independent Lung Ventilation (ILV).

Note:

During ILV, the alarm limits for each ventilator should be set to appropriate levels for each ventilator to assure appropriate patient protection. Confirm apnea timer settings and apnea ventilation settings for the Slave ventilator. These settings will be used in the event of a loss of signal from the Master ventilator.

WARNING

Since the master ventilator controls the breath rate for both ventilators, care should be taken when setting the other independent breath controls for the slave ventilator, to ensure sufficient time is allowed for exhalation to occur.

CAUTION

If the cable connecting the master and slave ventilators becomes detached, the slave ventilator will alarm for loss of signal. In this event, only the master ventilator will continue to provide ventilation at the current settings. The slave ventilator will begin apnea ventilation after its apnea timer has elapsed at its current apnea ventilation settings.

Chapter 4: Monitors, Displays and Maneuvers

Graphic Displays

Graphics Colors

Graphic displays on AVEA may appear as red, blue, yellow, green or purple tracings. These colors may provide useful information to the operator about breath delivery and are **consistent between both waveform and loop graphic displays.**

A **RED** tracing indicates the inspiratory portion of a mandatory breath. A **YELLOW** tracing indicates the inspiratory portion of an assisted or spontaneous breath (patient assisted or spontaneous breaths are also denoted with a yellow demand indicator that appears in the left hand corner of the mode indicator). **BLUE** tracings represent the expiratory phase of a mandatory, assisted or spontaneous breath. A **GREEN** tracing during the expiratory phase of a single breath indicates that a purge of the expiratory flow sensor or the wye flow sensor (if attached) has occurred. A **PURPLE** tracing indicates safety state, which occurs when the safety valve is open.

Waveforms

Three waveforms can be selected and simultaneously displayed on the MAIN screen as shown in Figure 4–1.

Note:

Waveforms are circuit compliance compensated for pediatric and adult patient sizes.

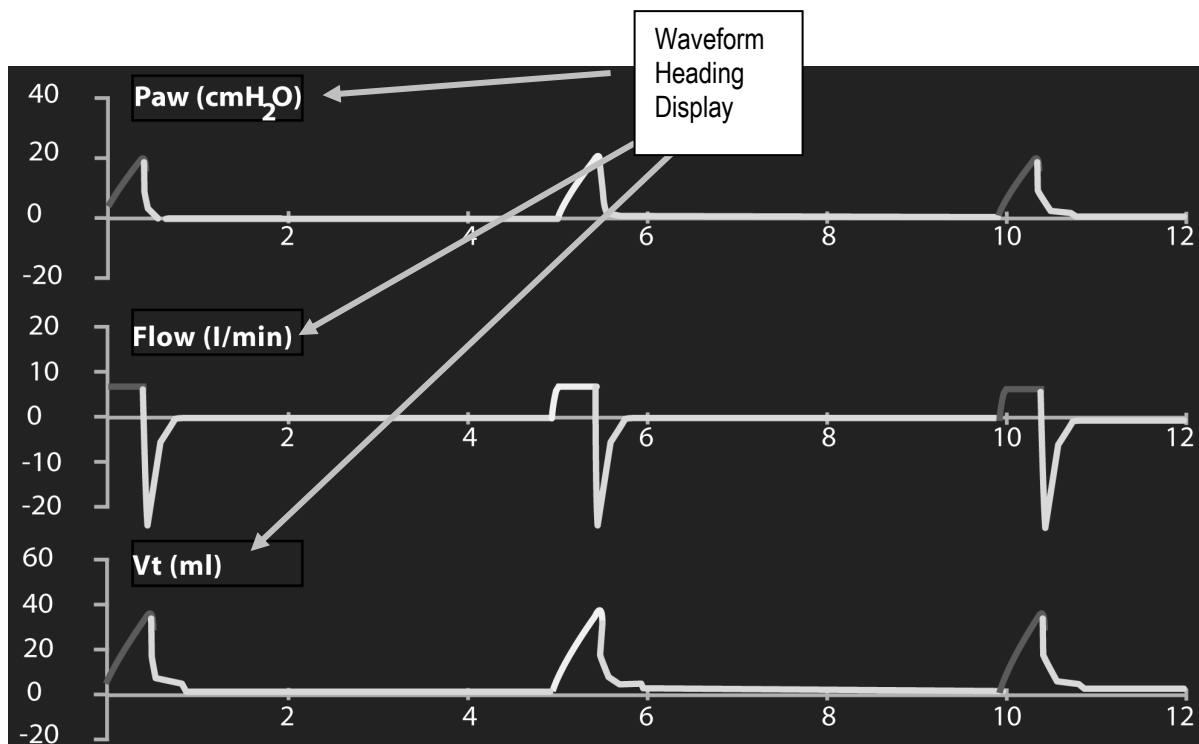

Figure 4–1: Waveform Graphs Displayed on the Main Screen

When you press and highlight the waveform heading display on the touch screen a scrollable menu appears showing the choice of waveforms (Figure 4–2).

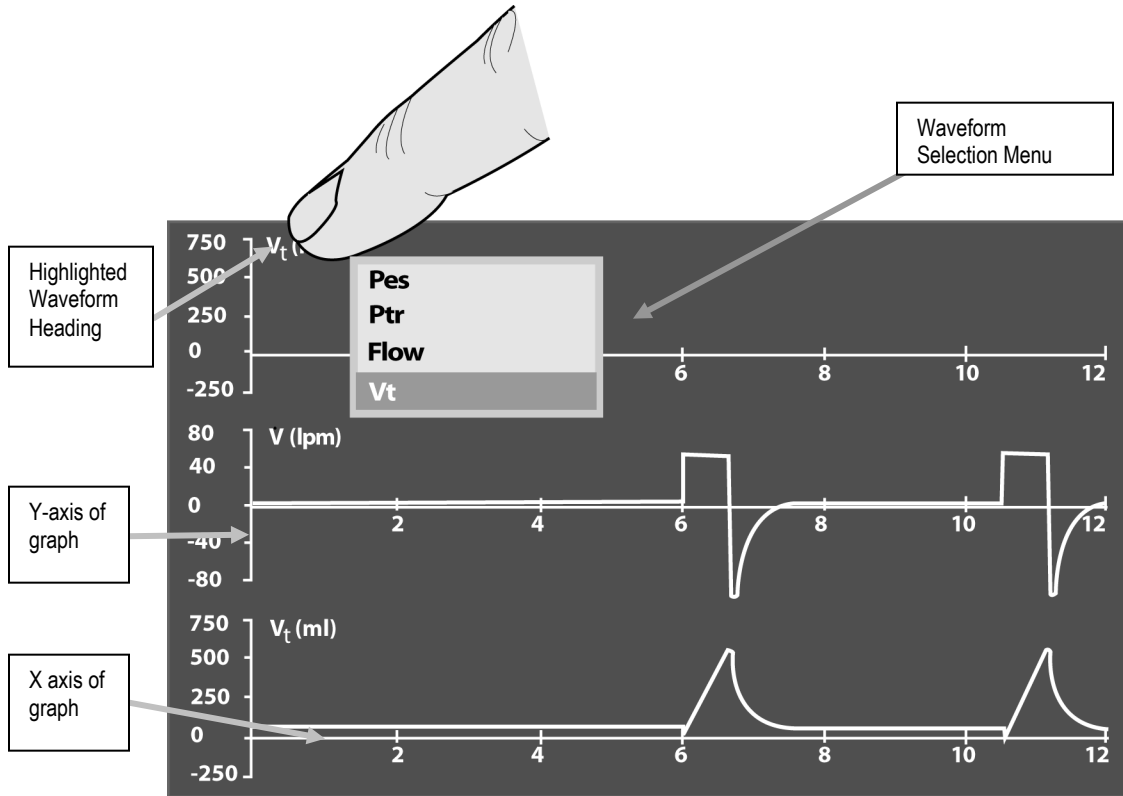

Figure 4–2: Waveform Selection

To scroll through the waveform choices, turn the data dial under the touch screen. To make your selection, touch the touch screen menu again or press the Accept membrane button shown here next to the data dial.

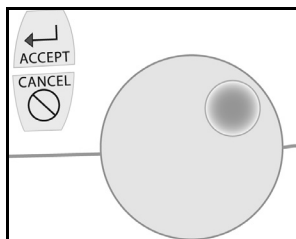

Figure 4–3: Data dial

Each waveform is continuously updated unless the PRINT or FREEZE membrane button is pressed.

The PRINT button transfers data to a connected parallel printer.

The FREEZE button freezes the current screen and suspends the screen update until pressed a second time.

Table 4–1: Waveform Choices

Heading Display	Waveform Shown
P_{aw} (cm H ₂ O)	Airway Pressure
P_{insp} (cmH ₂ O)	Airway Pressure at Machine Outlet
P_{es} (cmH ₂ O)	Esophageal Pressure
P_{tr} (cmH ₂ O)	Tracheal Pressure
P_{tp} (cmH ₂ O)	Transpulmonary Pressure
Flow(L/min)	Flow
V_t (ml)	Airway Tidal Volume
F_{exp}	Expiratory flow
F_{insp}	Inspiratory Flow
PCO_2	CO ₂ value through the respiratory cycle
Analog 0	Based on analog input scale
Analog 1	Based on analog input scale
PCO_2	CO ₂ level through respiratory cycle

Axis Ranges

The scale (vertical axis) and sweep speed (horizontal axis) of the displayed graphs are also modifiable using the touch screen. To change the displayed range, press either axis of the displayed graph to highlight it. The highlighted axis can then be modified using the data dial below the touch screen (Figure 4–3). To accept the change, touch the highlighted axis again or press Accept.

Time Ranges

0 to 6 seconds

0 to 12 seconds

0 to 30 seconds

0 to 60 seconds

Loops

Accessing the Loops Screen

To access the loops screen press the screens membrane button to the left of the touch screen on the UIM. The button is labeled with the icons shown here.

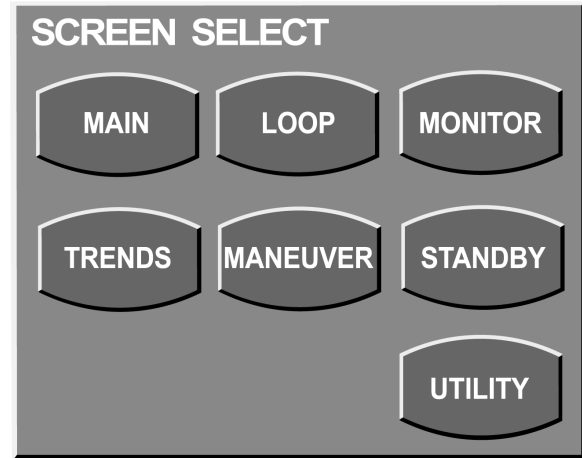
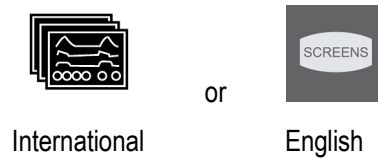

Select LOOP from the options that appear.

Figure 4–4: Screen Selection

Choice of Loops

The ventilator displays 2 loops in real time, selected from the following.

- Vt-Flow** Flow / Volume Loop. Inspiratory flow / Volume. If proximal flow sensor is used values are based on proximal flow sensor measurements. Available for all patients.
- PAW - Vt** Airway Pressure / Volume loop. Active for all patients.
- PES - Vt** Esophageal Pressure vs. Volume loop. This requires the use of an optional esophageal catheter and is active for adult and pediatric patients only.
- PTR - Vt** Tracheal Pressure vs. Volume loop. This requires the use of an optional tracheal catheter and is active for adult and pediatric patients only.
- P_{INSP} - Vt** Inspiratory Pressure vs. Volume loop.
- P_{TP} - Vt** Transpulmonary vs. Volume. This requires the use of an optional esophageal catheter and is active for adult and pediatric patients only.
- PCO₂/Vte** Exhaled CO₂ vs. Exhaled Vt

Note:

Loops are circuit compliance compensated for pediatric and adult patient sizes.

Using the Freeze Button to Compare Loops

You can freeze the Loops screen and select a reference loop for comparison. When real-time data refreshing resumes (by pressing the Freeze button again), the selected loop will remain in the background behind the real time graphic.

To create a reference loop refer to Figure 4–6, Figure 4–7, and Figure 4–8 and do the following.

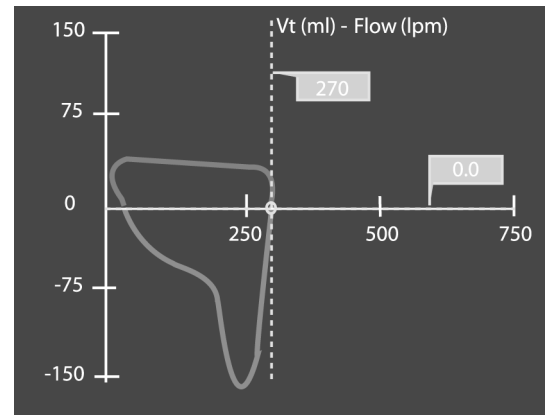

Figure 4–5: Frozen Flow / Volume Loop

Saving a loop

Press the Freeze button to freeze the loop you wish to use as a reference then press the Save Loop touch screen display in the **right** hand bar, beneath the frozen graphic display (Figure 4–6).



Figure 4–6: Reference Loop ON/OFF button (OFF)

This puts the selected loop into memory and places a time reference into a field in the **left** hand bar beneath the graphics display as shown in Figure 4–7. A total of four (4) loops can be saved at one time. When the fifth loop is saved, the oldest loop is removed.

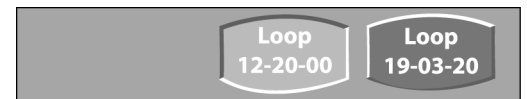

Figure 4–7: Saved Loops Display

Creating a reference loop

Press the touch screen directly over the touch screen field in the **left** bar which represents the saved loop you wish to use as a reference. The field will highlight (Figure 4–7). Press the “Ref Loop ON/OFF” field on the **right** hand bar (Figure 4–6 and Figure 4–8) to turn the reference loop on.



Figure 4–8: Reference Loop ON/OFF button (ON)

When you press the Freeze button again, the reference loop remains visible in the background, while the active display places current loops in real time over the top of it.

To turn off the reference loop, freeze the screen again and press the Ref Loop On/Off toggle button shown in Figure 4–8.

Maneuvers

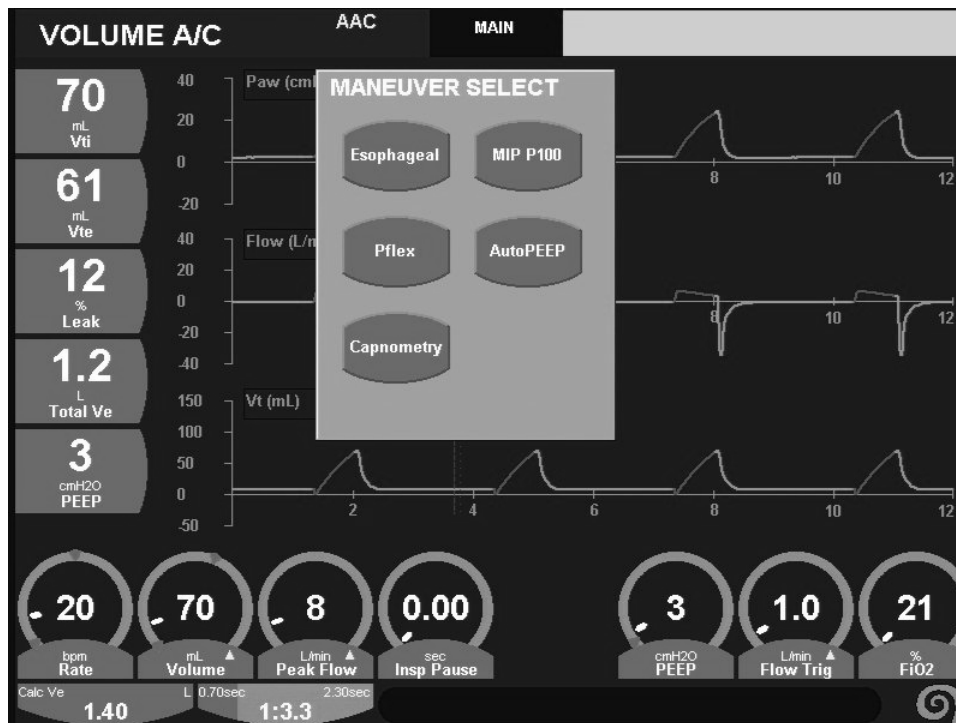

Figure 4–9: Maneuver Selection

The AVEA is capable of performing various respiratory mechanics maneuvers. These maneuvers can be accessed from the screens menu and selecting the Maneuvers screen. Depending on the model, the following maneuvers may be available: Esophageal, MIP / P_{100} , Inflection Point (P_{flex}), and AutoPEEP_{AW}. Each maneuver screen includes all controls, monitors, and waveform or loop graphics pertinent to the selected maneuver.

Note:

Maneuvers are not available for Neonate patients. Some alarms may be disabled during a maneuver.

Note:

The initiation of an AutoPEEP or Pflex maneuver will terminate Apnea ventilation.

Esophageal Maneuver Screen

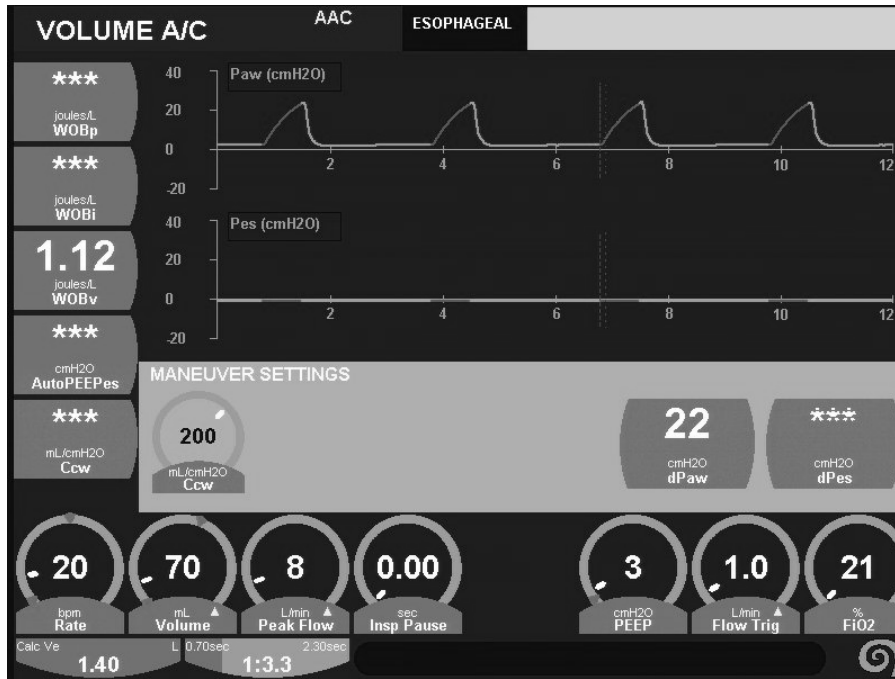

Figure 4–10: Esophageal Maneuver Settings

Controls

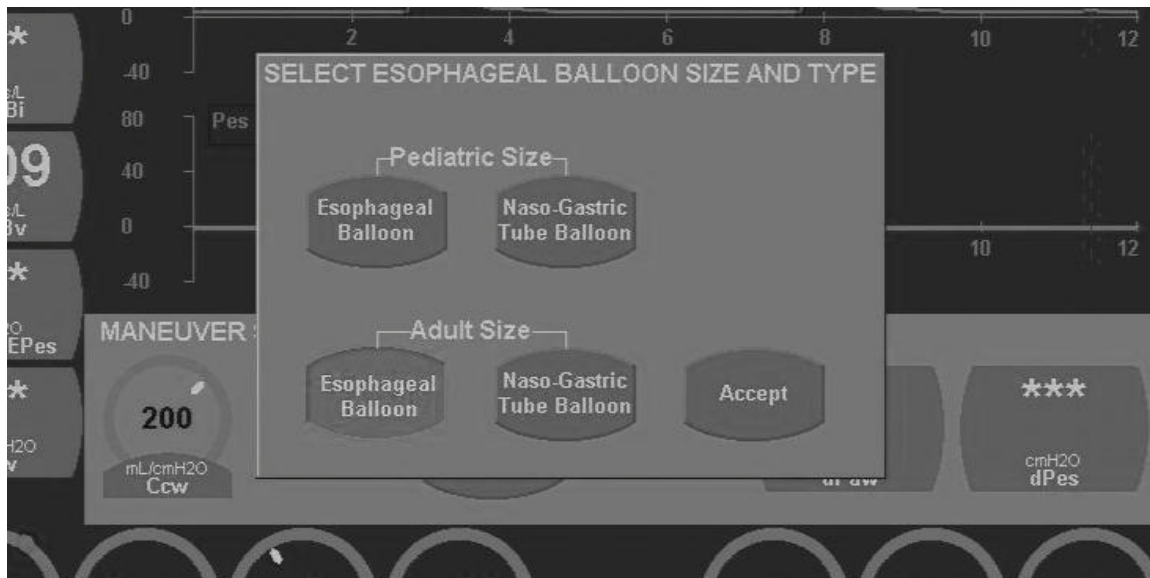

Figure 4–11: Select Esophageal Balloon Size and Type

Selecting Balloon Size and Type

Upon connection of the Balloon Extension Tubing the ventilator will display the Esophageal Balloon Size and Type dialogue box. You must select the size and type of balloon you intend to use before you will be able to conduct the Balloon Test.

Note:

Disconnecting the Balloon Extension Tubing will require you to select balloon size and type and repeat the balloon test procedure.

In order to change balloon size or type you must disconnect and re-connect the balloon extension tubing to open the Esophageal Balloon Size and Type dialogue box.

Selecting a balloon size and type other than the one to be used can result in failure of the balloon test.

Balloon Leak / Size Test

The Balloon Test verifies the integrity and size of the balloon catheter. The ventilator will display a Pass or Fail message in the message bar at the bottom of the screen.

If the Balloon Test is not passed all connections should be checked to assure they are secure and balloon integrity should be evaluated.

Note:

The Balloon Test must be performed **without the balloon in the patient**

Balloon Fill Start / Stop

When the Start key is actuated, the ventilator delivers the volume specified below into the catheter before esophageal pressure measurement commences.

Adult Catheter: 0.5 to 2.5 mL

Pediatric Catheter: 0.5 to 1.25 mL

The ventilator will evacuate and refill the balloon every 30 minutes to maintain measurement accuracy.

When the Stop key is actuated, the ventilator evacuates the balloon prior to removal of the catheter from the patient.

Note:

Do Not inflate the balloon until after it has been placed in the patient. The balloon should be evacuated prior to removal from patient.

Chest wall Compliance (C_{cw})

The preset Chest wall Compliance (C_{cw}) is used by the ventilator to calculate work of breathing.

Range: 0 to 300 mL/cmH₂O

Resolution: 1 mL/cmH₂O

Default: 200 mL/cmH₂O

Alarms

All currently available alarms are active during the Esophageal maneuver.

To Perform Esophageal Maneuvers

Esophageal measurements require the use of an esophageal balloon, which can be purchased from CareFusion.

From the Maneuvers Screen menu select Esophageal

Before placing the balloon in the patient a balloon test should be performed. Connect the esophageal balloon extension tubing to the EPM panel on the AVEA as described in Chapter 2. Remove the new esophageal balloon from its package and connect it to the pinned connector on the patient end of the extension tubing.

Allow the balloon to hang freely and not contact any surfaces and press the Balloon Test soft key on the maneuver screen. The ventilator will perform a leak test by evacuating the balloon, filling it to the proper specification, measuring the balloon pressure and finally evacuating the balloon. A message will appear on the message bar after the test stating Pass or Fail.

In the event that the balloon does not pass the leak test, inspect the balloon for damage and replace if necessary. If no damage is present on the balloon check all connectors on the balloon and extension tubing and repeat the test.

Note:

Disconnecting the balloon after passing a balloon test will require that the test be repeated.

Once the balloon has passed the leak test it is ready for placement in the patient. Proper placement of the balloon is imperative for accurate measurements. During insertion the waveform produced can provide information to confirm proper placement. An approximate level of placement can be made by measuring the distance from the tip of the nose to the bottom of the earlobe and then from the earlobe to the distal tip of the xiphoid process.

1. The esophageal pressure waveform correlates to the airway pressure in that they become positive during a positive pressure breath and negative during a spontaneous breath.
2. The esophageal tracing may show small cardiac oscillations reflective of cardiac activity.

3. Once placed using the above criteria appropriate balloon location can be confirmed by performing an occlusion technique. This requires that the airway be occluded and the esophageal and airway pressures compared for similarity.

After the balloon has been inserted and turned on, the ventilator will fill the balloon to the appropriate level and begin monitoring data. The ventilator will automatically evacuate and refill the balloon every thirty minutes to ensure accuracy of monitored values.

WARNING

Esophageal balloon placement should only be conducted in patients under the direction of a physician who has assessed the patients for contraindications to the use of esophageal balloons.

WARNING

Incorrect placement of an esophageal balloon can affect the accuracy of monitored values.

MIP / P₁₀₀ Maneuver Screen

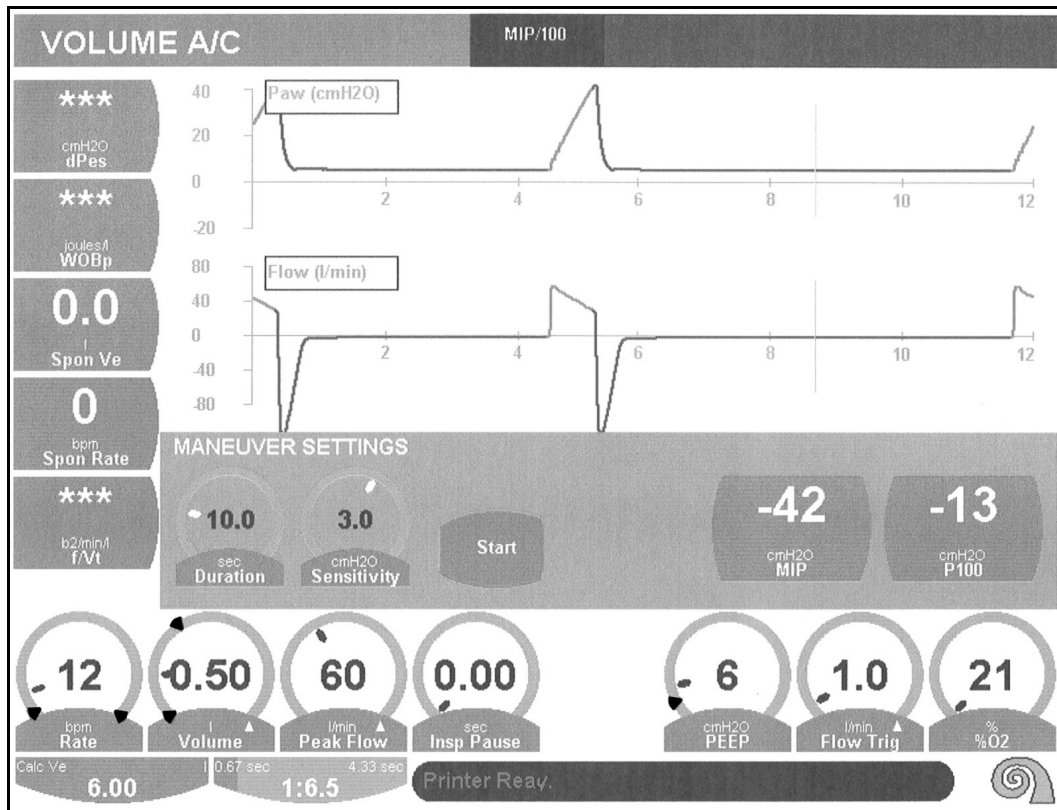

Figure 4–12: MIP Maneuver Settings

The MIP (Maximum Inspiratory Pressure) / P₁₀₀ maneuver measures the negative deflection in the pressure tracing during the patient’s active effort to demand a breath. During the maneuver, the inspiratory flow valve remains closed and no inspiratory flow is delivered. The MIP is an indication of the maximum negative pressure that the patient can draw, while P₁₀₀ is an indication of the pressure drop that occurs during the first 100 milliseconds of the breath.

Controls

Duration

The preset Duration shall determine the maximum amount of time that the maneuver will last. Normal ventilation will be suspended for the duration of the maneuver and will resume after the duration has timed out.

Range: 5.0 to 30.0 seconds

Default: 10 seconds

Sensitivity

The maneuver sensitivity establishes the level below PEEP that the airway pressure must drop, which determines the onset of a patient effort. This allows the clinician to set the maneuver appropriate to patient ability.

Range: 0.1 to 5.0 cmH₂O

Resolution: 0.1 cmH₂O

Default: 3.0 cmH₂O

Note:

Excessively high setting of the maneuver sensitivity can affect the accuracy of timing for P100 determination.

Start / Stop

The maneuver begins when the START key is actuated. The maneuver will be immediately terminated should the operator activate the STOP key and normal ventilation will resume.

Note:

If the Start key is activated during a mandatory inspiratory breath the maneuver will not commence until the ventilator cycles into exhalation and the minimum expiratory time of 150 msec has elapsed.

Alarms

All currently available alarms shall be active during the MIP / P₁₀₀ maneuver except Apnea Interval and Low PEEP.

To Perform a MIP / P100 Maneuver:

The MIP / P100 maneuver allows the measurement of the Maximum Inspiratory Pressure (MIP) achieved by the patient during an expiratory hold maneuver. The ventilator can also measure the P100 value which is the maximum inspiratory pressure achieved in the first 100 milliseconds of the maneuver.

From the Maneuvers Screen select MIP P100

The MIP maneuver screen allows the operator to set:

Duration – This is the time period that ventilation is suspended to conduct the maneuver. Once the Start button is depressed normal ventilation will be suspended until the Duration time period has elapsed **or** the operator presses the Stop button.

Sensitivity – This sets the sensitivity threshold that the ventilator uses to begin the timer for the P100 maneuver. The default position is 3 cmH₂O but can be adjusted by the operator to assure accuracy in patients with minimal inspiratory effort.

Note: The maneuver sensitivity setting is used for the maneuver only and does not affect trigger sensitivity.

Start / Stop – Starts and Stops the maneuver.

WARNING

Normal ventilation is suspended for the duration of the maneuver. The patient should be evaluated for contraindications prior to executing the maneuver. The patient should be directly monitored by trained medical personnel during the maneuver.

To execute a MIP / P100 maneuver set the Duration and Sensitivity controls to the desired level. Press the Start soft key on the maneuver screen. The ventilator will close the inspiratory and expiratory valves and begin monitoring. At the completion of the maneuver the ventilator will display the MIP and P100 values in their respective windows on the maneuver screen. The MIP and P100 will also be available as trended data on the Trends screen. The maneuver can be aborted at anytime by pressing the Stop soft key.

Inflection Point (P_{flex}) Maneuver Screen

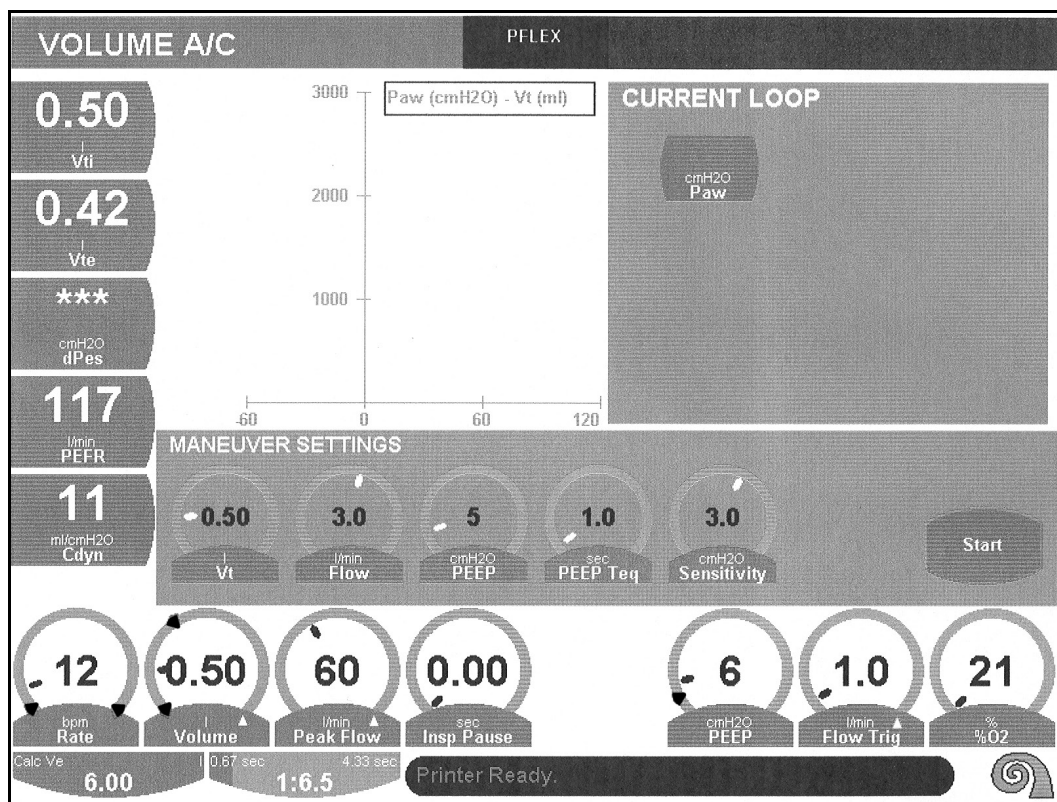

Figure 4–13: Pflex Maneuver Settings

The Inflection point (P_{flex}) maneuver is performed on patients during mandatory ventilation. The upper and lower inflection points are automatically indicated on the inspiratory portion of a Pressure/Volume (P_{AW} / Vol) Loop.

Note:

Normal ventilation shall be suspended for the duration of the maneuver. The maneuver will be aborted if a patient effort is detected and the message bar will indicate a message stating that patient effort was detected.

Controls**Tidal Volume (Volume)**

This is the volume of gas delivered to the patient during the maneuver.

Range: 0.10 to 2.50 L (Adult)
25 to 500 mL (Pediatric)

Resolution: 0.01 L (Adult)
1 mL (Pediatric)

Default: 0.25 L (Adult)
25 mL (Pediatric)

Peak Flow

Sets the Peak Flow used for the maneuver.

Note: A square wave flow pattern is used for the maneuver.

Range: 0.5 to 5.0 LPM

Resolution: 0.1 LPM

Default: 1.0 LPM

Maneuver PEEP (PEEP)

The Maneuver PEEP determines the baseline pressure at which the maneuver begins.

Note: The Maneuver PEEP can be set independent of the PEEP used during normal ventilation.

Range: 0 to 50 cmH₂O

Resolution: 1 cmH₂O

Default: 0 cmH₂O

PEEP Equilibration Time (PEEP T_{eq})

The PEEP Equilibration Time determines the amount of time allowed for equilibration of the airway pressure before slow flow commences. Upon activation of the maneuver the ventilator will set PEEP to the Maneuver PEEP level for the PEEP Equilibration Time prior to beginning the slow flow maneuver.

Range: 0.0 to 30.0 seconds

Resolution: 0.1 second

Default: 1.0 second

Sensitivity

The preset Sensitivity establishes the level below the peak airway pressure that the pressure must drop to abort the P_{flex} maneuver.

Note: The P_{flex} maneuver will be terminated if a leak greater than 100% is present.

Range: 0.1 to 5.0 cmH₂O

Resolution: 0.1 cmH₂O

Default: 3.0 cmH₂O

Start / Stop

The maneuver shall begin when the START key is actuated. The maneuver shall be immediately terminated when the STOP key is actuated, a patient effort is detected or the maneuver tidal volume has been delivered and normal ventilation will resume.

Note:

The initiation of a P_{flex} Maneuver is delayed by two factors. The total delay is equal to 25% of the breath interval plus the PEEP Equilibration time set. The PEEP Equilibration time has a range of 0–30 seconds. If the mandatory breath rate is 10 bpm, the breath interval is therefore 6 seconds and the delay to initiate P_{flex} is 1.5 seconds plus the PEEP equilibration time set. At the default PEEP Equilibration time of 1 second, the total delay is 2.5 seconds in this example. If the mandatory breath rate is set to 1 bpm, the breath interval is 60 seconds and the delay to initiate P_{flex} in this worst-case scenario is 15 seconds, plus the PEEP Equilibration time.

Upper P_{flex} and Lower P_{flex} determination

Once the maneuver tidal volume has been delivered the ventilator will cycle into exhalation. At the end of exhalation, the P_{AW} / Vol loop will freeze automatically, the upper and lower inflection points, as well as the delta P_{flex} volume, will be calculated and displayed. The ventilator will return to normal ventilation at the current ventilator settings.

The user can, should they choose to do so, override the P_{flex} values by moving the P_{flex} indicators to a new point along the PV loop and pressing the appropriate set key. The corresponding P_{flex} values and delta P_{flex} volume change to represent values based on the current position of the indicators. The ventilator will store up to four PV loops and their respective inflection points simultaneously.

Note:

Once the values have been redefined by the operator the original values cannot be restored.

Alarms

All currently available alarms shall be active during a P_{flex} maneuver except Apnea Interval and I-Time Limit.

To Perform a P_{flex} Maneuver

The P_{flex} maneuver allows the clinician to determine opening pressures of the lung during a slow flow volume controlled breath. Because this maneuver is performed at a slow inspiratory flow rate the effects of respiratory system resistance are minimized.

Note:

Performance of the P_{flex} maneuver requires a passive patient. In the event that a patient effort is detected the ventilator will abort the maneuver and deliver a patient effort detected message while simultaneously returning to normal ventilation at the current settings.

From the Maneuvers Screen select P_{flex}

The P_{flex} maneuver screen allows the operator to set:

Tidal Volume (Vt) – This is the tidal volume delivered to the patient during the maneuver. This setting has no effect on the settings during normal ventilation and can be set to any tidal volume desired independent of the current mode of ventilation.

Note:

The Tidal Volume setting during a Pflex maneuver is not circuit compliance compensated.

Flow – This setting is adjustable from 0.5 to 5 l/min and controls the inspiratory flow used to deliver the maneuver tidal volume.

PEEP – This is the PEEP used for the Slow Flow Maneuver. The operator can select any PEEP level independent of the control PEEP used during controlled ventilation.

PEEP_{Teq} – This control sets the equilibration at the Maneuver PEEP after which the Slow Flow Maneuver begins.

Sensitivity – This sets the sensitivity threshold that the ventilator uses to detect patient effort during the Slow Flow Maneuver. The default position is 3 cmH₂O but can be adjusted by the operator to assure accurate sensitivity in all applications.

Start / Stop – Starts and Stops the maneuver.

Note:

All maneuver control settings are independent of control settings in normal ventilation.

WARNING

Normal ventilation is suspended for the duration of the maneuver. The patient should be evaluated for contraindications prior to executing the maneuver. The patient should be directly monitored by trained medical personnel during the maneuver.

To execute a Pflex maneuver set the Tidal Volume, Flow, Maneuver PEEP, PEEP Equilibration time and Sensitivity. Press the Start soft key on the maneuver screen. The ventilator will suspend normal ventilation and begin delivering the Maneuver Tidal Volume at the set Flow. The corresponding Pressure / Volume curve will be drawn by the ventilator as the volume is delivered to the patient. Once complete the ventilator will automatically resume normal ventilation and Freeze the graphics display. The maneuver can be aborted at anytime by pressing the Stop soft key. If at anytime during the maneuver the ventilator detects a patient effort, the ventilator will cycle into exhalation and normal ventilation will resume.

The measured Pflex, Pflex Lwr, Pflex Upr and Vdelta will be displayed, if they can be determined. At this point the operator can choose to accept the inflection points as determined by the ventilator or the operator can choose to set the inflection points manually.

To set the inflection points manually simply scroll the cursor to the desired position with the Data Dial and press the Set Pflex Lwr or Set Pflex Upr softkey. The Vdelta will be automatically recalculated.

The measured data can be saved by pressing the Save Loop softkey. Up to four loops may be saved, when a fifth loop is saved the oldest loop and data will be erased.

Note:

If the loop and corresponding data are not saved by the operator, the data will be erased after exiting the maneuver screen.

AutoPEEP Maneuver Screen

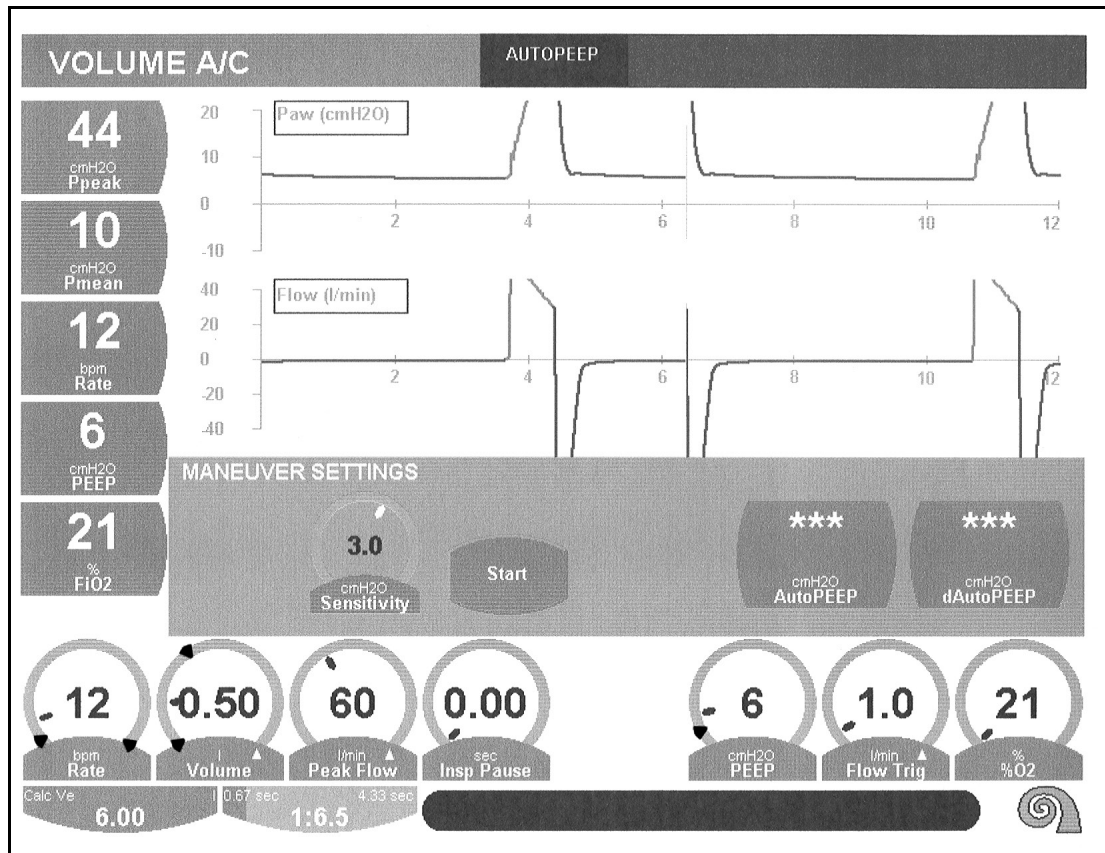

Figure 4-14: AutoPEEP Maneuver Settings

AutoPEEP is the airway pressure at the end of exhalation immediately prior to the beginning of the next mandatory inspiration. During the execution of this maneuver the ventilator will execute an expiratory hold in which both the inspiratory and expiratory valves will be closed. The ventilator will establish the AutoPEEP measurement when the system pressure reaches equilibration, at the next mandatory breath interval or 5 seconds whichever is shorter.

Controls

Sensitivity

The preset Sensitivity establishes the level that the airway pressure must drop below PEEP to abort the AutoPEEP maneuver.

Range: 0.1 to 5.0 cmH₂O

Resolution: 0.1 cmH₂O

Default: 3.0 cmH₂O

Start / Stop

The maneuver begins when the START key is actuated and the ventilator is in exhalation. The maneuver will stop immediately when the STOP key is activated, the maneuver is completed or a patient effort is detected and normal ventilation will resume.

Note:

The maneuver will be aborted if a patient effort is detected and the message bar will indicate a message stating that patient effort was detected.

Alarms

All currently available alarms shall be active during the AutoPEEP maneuver.

To Perform an AutoPEEP Maneuver

The AutoPEEP maneuver allows the measurement of PEEP generated within the breathing system (patient and circuit) during an expiratory hold maneuver. This maneuver requires a passive patient.

From the Maneuvers Screen select AutoPEEP

The AutoPEEP maneuver screen allows the operator to set:

Sensitivity – This sets the sensitivity threshold that the ventilator uses to detect patient effort during the AutoPEEP Maneuver. The default position is 3 cmH₂O but can be adjusted by the operator to assure accurate sensitivity in all applications.

Start / Stop – Starts and Stops the maneuver.

To execute an AutoPEEP maneuver the operator sets the Sensitivity appropriate for the patient and presses the Start softkey. The ventilator will then close the inspiratory and expiratory valves and allow the pressure to equilibrate between the patient and the breathing circuit. At the completion of the maneuver the ventilator will display the AutoPEEP and dAutoPEEP values in their respective windows on the maneuver screen. The AutoPEEP and dAutoPEEP will also be available as trended data on the Trends screen. The maneuver can be aborted at anytime by pressing the Stop soft key.

Note:

The AutoPEEP value will be set at the next mandatory breath interval or 5 seconds whichever is sooner.

Capnometry Screen

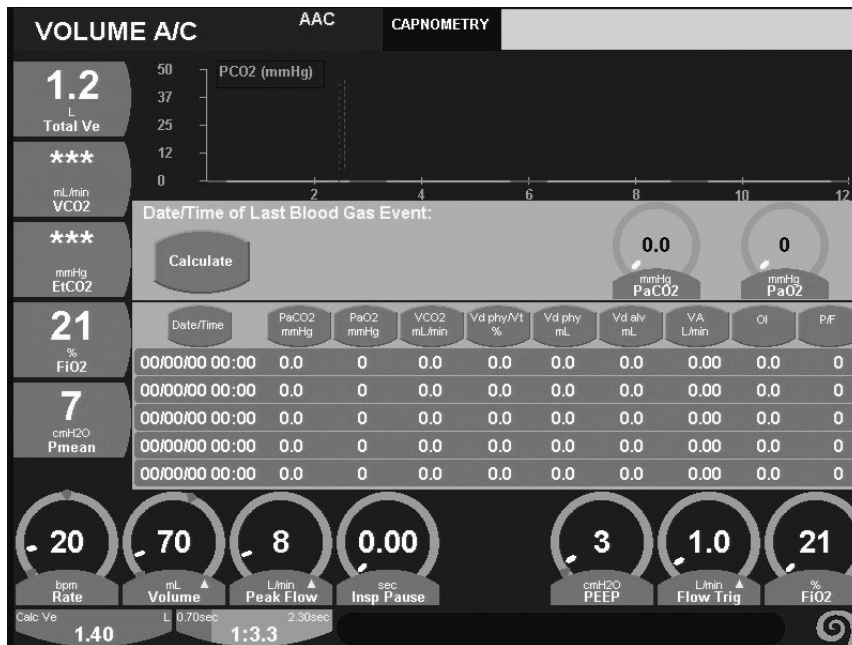

Figure 4-15: Capnometry Screen in Maneuvers Selection

Note:

See “Chapter 5: Volumetric Capnography”.

Tracheal Catheter Placement

Some advanced mechanics measurements on the AVEA require the use of a tracheal catheter. To ensure accuracy of measurements and to minimize risk of adverse events the tracheal catheter should be placed in the endotracheal tube and not extend beyond the tip.

To assure proper placement, measure the length of the endotracheal tube, and its associated adapters. Insert the tracheal catheter into the endotracheal tube to a distance not greater than this measurement.

WARNING

Inserting the tracheal catheter beyond the tip of the endotracheal tube may cause irritation and inflammation of the trachea and airways or produce vagal responses in some patients.

Digital Displays

The Monitor Screen

To access the monitor screen press the Screens membrane button to the left of the touch screen on the UIM. The button is labeled with the icon shown here.

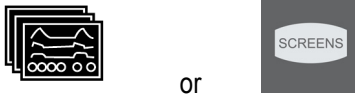

or

International

English

Select MONITOR from the selection box that appears.

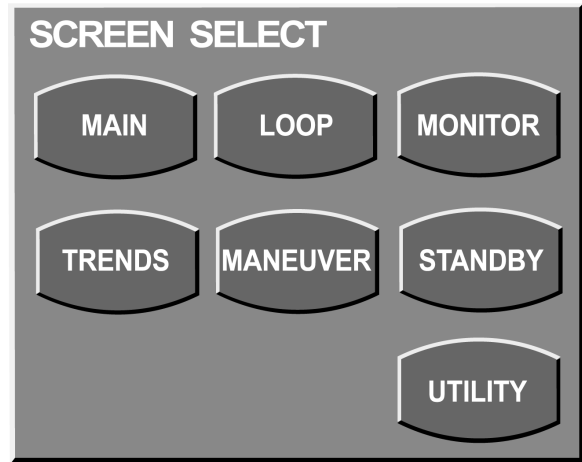

Figure 4–16: Screen Selection

The monitor screen can display a total of 15 different monitored values simultaneously. Monitor Displays are updated at the start of the next inspiration or every 10 seconds, whichever occurs first. Each value can be independently selected from the available choices (see Table 4–2).

1. Use the touch screen to select and highlight the monitor you wish to set.
2. Turn the data dial beneath the touch screen to scroll through the menu choices.
3. To accept your selection, either touch the highlighted display or press the accept button adjacent to the data dial (Figure 4–17).



Figure 4–17: The Monitor Screen

Table 4–2: Monitored Values Menu Choices

For a full description of the specifications and calculation of monitored displays (see “Appendix D: Monitor Ranges and Accuracies”).

Note:

Depending on the model and options, not all of the following displays may be available.

Display	Value
ml Vte	Expired tidal volume
ml/kg Vte/kg	Expired tidal volume adjusted for patient weight
ml Vti	Inspired tidal volume
ml Vti/kg	Inspired tidal volume adjusted for patient weight
ml Spon Vte	Spontaneous tidal volume exhaled
ml/Kg Spon Vte/Kg	Spontaneous tidal volume adjusted for patient weight exhaled
ml Mand Vte	Mandatory tidal volume exhaled
ml/kg Mand Vte/Kg	Mandatory tidal volume adjusted for patient weight exhaled
Vdel	This is the uncorrected tidal volume measured by the inspiratory flow sensor inside the ventilator.
Leak	Percent leakage
L Total Ve	Minute Volume
ml/kg Total Ve/kg	Minute volume adjusted for patient weight
L Spon Ve	Spontaneous minute volume
ml/kg Spon Ve/kg	Spontaneous minute volume adjusted for patient weight
bpm Rate	Total Breath Rate (spontaneous and mandatory)
bpm Spon Rate	Spontaneous breath rate
bpm Mand Rate	Mandatory Breath Rate
sec Ti	Inspiratory time
sec Te	Expiratory Time
I:E	Inspiratory/expiratory ratio
B ² /Min/L f/Vt	Rapid shallow breathing index
cmH ₂ O Ppeak	Peak inspiratory pressure

Display	Value
cmH₂O P_{mean}	Mean inspiratory pressure
cmH₂O P_{plat}	Plateau pressure
P_{tp} Plat	The ventilator is capable of calculating and displaying the Transpulmonary pressure during an inspiratory hold, which is the difference between the airway plateau pressure (P _{plat aw}) and the corresponding esophageal pressure.
cmH₂O PEEP	Positive end expiratory pressure
P_{baro}	Barometric pressure
psig Air Inlet	Air inlet pressure
psig O₂ Inlet	Oxygen inlet pressure
% F_{IO₂}	Percentage of oxygen
ml/cmH₂O C_{dyn}	Dynamic compliance
ml/cmH₂O C_{dyn/Kg}	Dynamic compliance adjusted for patient weight
ml/cmH₂O C_{stat}	Respiratory system compliance (Static compliance)
ml/cmH₂O C_{stat/Kg}	Respiratory system compliance adjusted for patient weight (Static compliance)
C₂₀/C	Ratio of the dynamic compliance during the last 20% of inspiration (C ₂₀) to the total dynamic compliance (C).
F/V_t	Rapid Shallow Breathing Index (f / V _t) which is the spontaneous breath rate per tidal volume
cmH₂O/LPS R_{rs}	Respiratory system resistance
L/min PIFR	Peak Inspiratory flow rate
L/min PEFR	Peak Expiratory flow rate
R_{RS}	Respiratory System Resistance (R _{RS}), is the total resistance during the inspiratory phase of a breath
R_{PEAK}	Peak Expiratory Resistance (R _{PEAK}) is defined as the resistance at the time of the Peak Expiratory Flow (PEFR).
R_{IMP}	Imposed Resistance (R _{IMP}), is the airway resistance between the wye of the patient circuit and the tracheal sensor
R_{LUNG}	Lung Resistance (R _{LUNG}), is the ratio of the tracheal pressure differential to the inspiratory flow 12 ms prior to the end of inspiration
PIFR	The actual peak inspiratory flow rate for the inspiratory phase of a breath.
PEFR	The actual peak expiratory flow rate for the expiratory phase of a breath.
dP_{AW}	Delta Airway Pressure (dP _{AW}), is the difference between peak airway pressure and baseline airway pressure.
dP_{ES}	Delta Esophageal Pressure (dP _{ES}), is the difference between peak esophageal pressure and baseline esophageal pressure
WOB_P	Patient Work of Breathing (WOB _P), normalized to the total inspiratory tidal volume
WOB_I	Imposed Work of Breathing (WOB _I), is defined as the work performed by the patient to breathe spontaneously through the breathing apparatus, i.e. the E.T. tube, the breathing circuit, and the demand flow system.

Display	Value
WOB_v	Ventilator Work of Breathing (WOB _v), is the summation of airway pressure minus the baseline airway pressure times the change in tidal volume to the patient during inspiration, and normalized to the total inspiratory tidal volume
AutoPEEP	AutoPEEP, is the airway pressure at the end of an expiratory hold maneuver.
dAutoPEEP	Delta AutoPEEP (dAutoPEEP), is the difference between airway pressure at the end of an expiratory hold maneuver and the airway pressure at the start of the next scheduled breath after the expiratory hold maneuver
P_{tp} PEEP	Transpulmonary pressure, AutoPEEP (P _{tp} PEEP) is the difference between the corresponding airway and the esophageal pressures at the end of the expiratory hold during an AutoPEEP maneuver.
AutoPEEP_{ES}	AutoPEEP _{ES} is the difference between esophageal pressure measured at the end of exhalation minus the esophageal pressure measured at the start of a patient-initiated breath and the sensitivity of the ventilator's demand system
C_{cw}	Chest wall Compliance (C _{cw}), is the ratio of the tidal volume (exhaled) to the Delta Esophageal Pressure (dP _{ES}).
C_{LUNG}	Lung Compliance (C _{LUNG}), is the ratio of the tidal volume (exhaled) to the delta transpulmonary pressure
P_{tp} Plat	Transpulmonary pressure during an inspiratory hold
MIP	Maximum Inspiratory Pressure is the maximum negative airway pressure that is achieved by the patient, during an expiratory hold maneuver
P₁₀₀	Respiratory Drive (P ₁₀₀), is the negative pressure that occurs 100 ms after an inspiratory effort has been detected
nCPAP	Mean airway pressure while in nCPAP mode
CPAP Flow	Mean inspiratory flow while in nCPAP mode
EtCO₂	Peak expired CO ₂ as measured and reported by the CO ₂ sensor in the airway. EtCO ₂ is measured for each breath. Display is either a breath-by-breath or averaged measurement.
VCO₂	The amount of CO ₂ eliminated every minute. This is calculated over each minute and then averaged over the set VCO ₂ averaging time.
VtCO₂	The amount of CO ₂ exhaled per breath. It is measured for each breath and then averaged over the set VCO ₂ averaging time.
V_{dana}	The volume of dead space in the patient's airway. Anatomical dead space is measured for each breath. This value is averaged over the set VCO ₂ averaging time.
V_{dana}/V_t	V _d /V _t ana is averaged over the set VCO ₂ averaging time.

Events

Pressing the EVENT membrane button to the left of the touch screen opens a scrollable menu of event markers that are placed in the trend buffer along with the 66 monitored parameters. To select an event use the data dial to scroll the event menu and highlight the desired event. Press the ACCEPT button adjacent to the data dial to place the event in the trend buffer. Events will appear on the data spreadsheet in green text with an asterisk next to the time code (see "Trends" below).

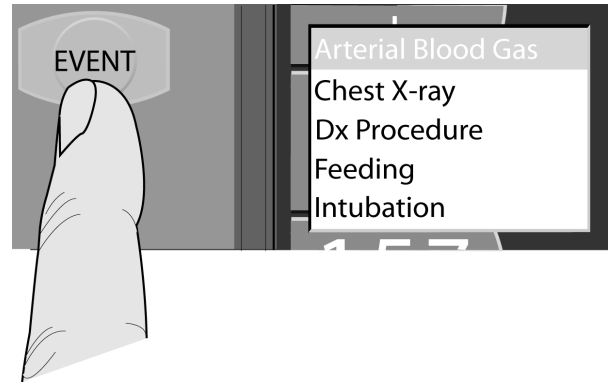

Figure 4–18: The Events menu

Selectable events include:

Event	Abbreviation
Blood Gas	BG
Chest X-ray	CXR
Diagnostic (Dx) Procedure	Dx
Feeding	Feed
Intubation	ETT
Therapeutic (Rx) Procedure	Rx
Suction	Sxn

The following events are automatically recorded in the event log:

Event	Abbreviation
Change a primary or advanced control setting	Stgs
Powering the ventilator on	Pon
Powering the ventilator off	Poff
Entering Standby	eSby
exiting Standby	xSby
Activation of the nebulizer	Neb
Activation of the expiratory hold	eHold
Activation of the inspiratory hold	iHold
A manual breath	Man
Activation of the suction button	Sxn
Activation of the increase O ₂ button	IncO ₂
Activation of New Patient	NwPt
Involuntary Power Loss & Recovery	Prec

Trends

The monitored parameters described in the previous section are trended as one minute averaged values over a running 24-hour period. Trend data is accessed by pressing the screen button on the membrane panel to the left of the touch screen or by pressing the screen indicator in the top center portion of the touch screen display. The screen menu will appear. Press the TREND button on the screen menu to open the trends screen.



Figure 4-19: The Trends Window

Note:

If left open the Trends Window will update every 10 minutes.

Four histograms and a spreadsheet are displayed on the touch screen. Each histogram and column on the spreadsheet can be configured from the list of monitored parameters as well as events. Touch the title bar of any histogram or the heading of any column to open a scrollable menu. Move through the list by turning the data dial. Highlight the item to be displayed and press the highlighted display or the ACCEPT button above the data dial to accept the new item for display.

Histograms can be scaled by touching either axis. With the axis highlighted, use the data dial to adjust the scale. Touch the axis again or press the ACCEPT button to accept the change.

To look at histogram or spreadsheet trends over time, press the FREEZE button and use the data dial to move the cursor through the time line. The time line is shown as yellow text on the spreadsheet. Event markers appear in green text.

Note:

Changing the date / time back on the instrument's internal clock erases stored trend data.

Main Screen Displays

Calculated I:E Ratio

The AVEA displays the calculated I:E Ratio (Calc I:E) based on the set breath rate, set tidal volume, and set peak flow for Volume breaths, or the set breath rate and set inspiratory time for Pressure, TCPL, and PRVC breaths. The display is located next to the Calculated Minute Volume display at the bottom left of the Main screen. This display is updated while the data dial is being rotated when changing any of the primary patient settings that affect these displays in order to view the Calculated I:E Ratio that results when the setting change is accepted, before accepting that change. This display reverts to the previously established values if the setting change is cancelled or times out.



Figure 4–20: Calculated I:E Ratio Display

Range: 1:99.9 to 99.9:1

Limitations: For Volume breaths, the calculated I:E Ratio shall only change if the set tidal volume, set breath rate, or set peak flow is changed. For Pressure, TCPL, PRVC, breaths, the calculated I:E Ratio shall only change if the set breath rate or set inspiratory time is changed.

Note:

Calculated I:E ratio is not active in APRV / BIPHASIC mode

Calculated Minute Volume (Calc Ve)

The ventilator displays the Calculated Minute Volume at the bottom left of the Main screen as follows:

$$\text{Calc } V_e = [(\text{Set tidal volume}) \times (\text{Set breath rate})]$$

This display is updated while the data dial is being rotated when changing any of the primary patient settings that affect these displays in order to view the Calculated V_e that results when the setting change is accepted, before accepting that change. This display reverts to the previously established values if the setting change is cancelled or times out.

Limitation: For Volume breaths only. The Calc V_e display only changes if the set tidal volume or set breath rate is changed.

Calculated Time High & Time Low Min / Max

The AVEA displays the calculated minimum and maximum Time High and Time Low in APRV / BiPhasic ventilation. The display is located immediately under the Time High and Time Low primary controls on the main screen.

Calculated Time High: Time Low Ratio

The AVEA displays the calculated ratio corresponding to the ratio of Time High divided by Time Low in APRV / BiPhasic ventilation. The display is located between the displays of Time High and Time Low (where the minimums and maximums are displayed) and below the display of the Pressure High setting. This ratio is presented similarly to an I:E Ratio, but it is actually a Time High :Time Low Ratio. The ratio is displayed in the same format as an I:E Ratio with the same rules for transitioning from ratios less than one to ratios greater than one (1:1.1 to 1.1:1). This display is also updated dynamically while the data dial is being rotated when changing any of the patient settings that affect this display. This display also reverts to the previously established ratio if the setting change is cancelled or times out.

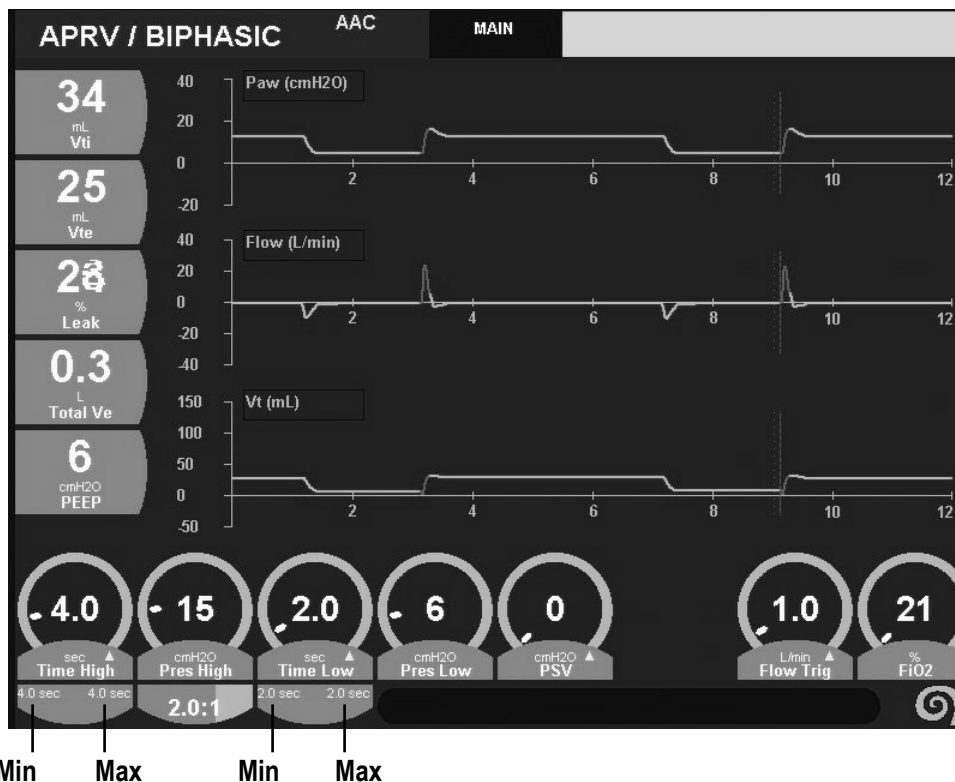

Figure 4–21: Calculated T High / T Low

Note:

Time High and Time Low are **maximum** time settings for a time-cycled transition. Actual times may vary depending on the patient’s spontaneous breathing pattern and the Sync window setting.

Main Screen Monitors

Five monitored parameters are continuously displayed to the left of the graphic displays. These are selected in the same way as the displays on the Monitors screen.

1. Use the touch screen to select and highlight the monitor you wish to set.
2. Turn the data dial beneath the touch screen to scroll through the menu choices.
3. To accept your selection, either touch the highlighted display or press the accept button adjacent to the data dial.

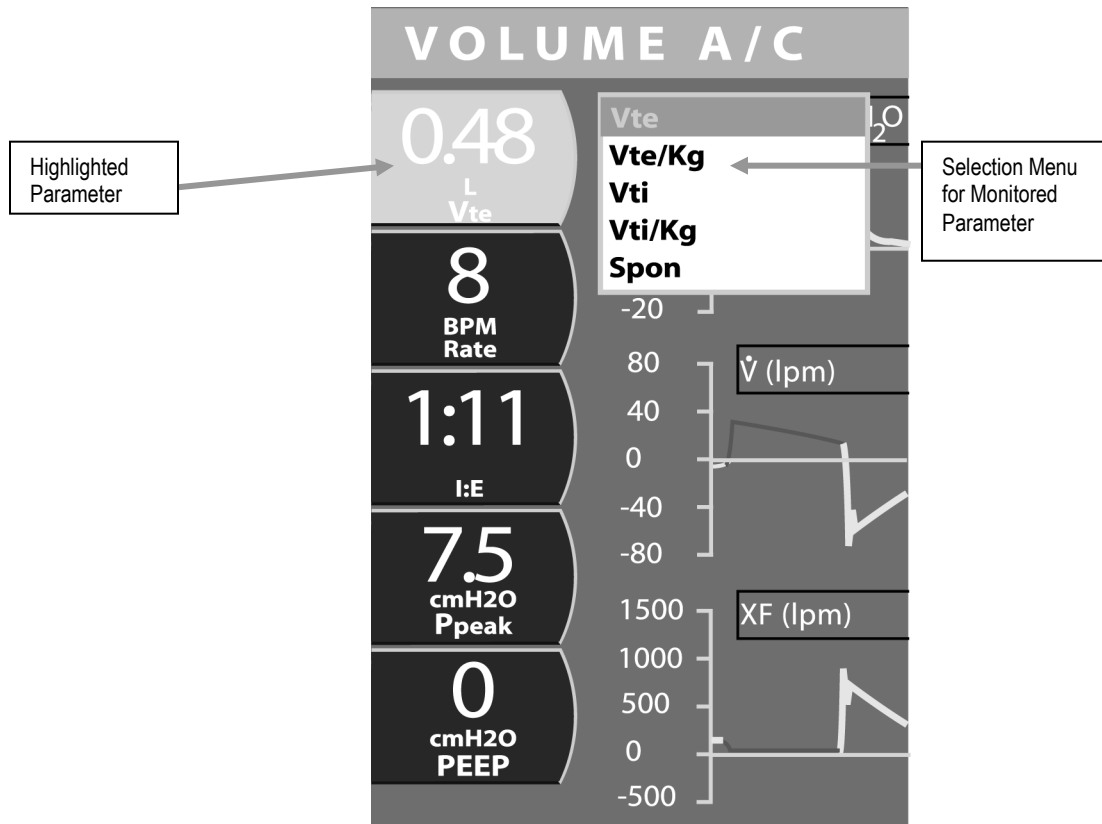

Figure 4–22: Selectable Monitored Parameters Displayed on the Main Screen

Note:

The main screen monitored parameters may be different than the monitored parameters on the loops or trends screens.

Chapter 5: Volumetric Capnography

Introduction

The Volumetric Capnography, V_{CO_2} Option for AVEA adds new monitoring and advanced calculation features. The option requires purchase of the sensor and a software activation. In addition to traditional $ETCO_2$ and capnography, there are features that assist the clinician with patient evaluation.

Warnings

Periodically check the CO_2 sensor for excessive moisture or secretion build up.

Volumetric capnography measurements require accurate measurement of delivered volumes. For this reason, a proximal flow sensor or circuit compliance compensation must be used. Furthermore, when circuit compliance compensation is used, and if the circuit compliance changes, volumetric accuracy will be altered.

A system leak, such as that caused by un-cuffed endotracheal tubes may affect flow-related readings. These include flow, pressure, dead space, CO_2 production, and other respiratory mechanics parameters.

Nitrous oxide, excessive levels of oxygen, helium, and halogenated hydrocarbons can influence the CO_2 measurements. The AVEA compensates for oxygen and helium gas automatically.

Do not use CO_2 measurements as the sole basis for changing ventilation parameters without reference to clinical condition and independent monitors such as blood gas. CO_2 measurements may be inaccurate in the presence of a breathing circuit leak, secretions, or sensor malfunction.

Do not position the CO_2 sensor or cable in any manner that may cause entanglement, strangulation, or accidental self-extubation. Use clips as appropriate to secure the sensor cable to the breathing circuit.

Do not use $EtCO_2$ as basis for changing ventilation parameters without reference to clinical condition and independent monitors such as blood gas.

Cautions

The CAPNOSTAT® 5 contains no user serviceable parts.

Do not use damaged sensors or cables.

Do not sterilize or immerse sensors, except as directed in this manual.

Do not apply excessive tension to any sensor cable.

It is recommended that the CO_2 sensor be removed from the circuit whenever an aerosolized medication is delivered. This is due to the increased viscosity of the medications, which may contaminate the sensor windows, causing the sensor to fail prematurely or to display incorrect data.

Theory of Operation

The CAPNOSTAT® 5 measures CO_2 by using the infrared absorption technique, which has endured and evolved in the clinical setting for over the past two decades and remains the most popular and versatile technique. The principle is based on the fact that CO_2 molecules absorb infrared (IR) light energy of specific wavelengths with the amount of energy absorbed being directly related to the CO_2 concentration. When an IR beam is passed through a gas sample containing CO_2 , the electronic signal from the photo detector (which measures the remaining light energy) can be obtained. This signal is then compared to the energy of the IR source and calibrated to accurately reflect CO_2 concentration in the sample.

Setup

1. Attach the end of the CO₂ sensor cable to the connection on the bottom of the AVEA UIM labeled EtCO₂.



Figure 5–1: Bottom of AVEA UIM

Note:

Only capnography cables supplied by CareFusion are compatible with the AVEA.

WARNING!

Route the sensor cable so as to avoid risk of patient entanglement or accidental extubation. Clips are available to secure the cable to the breathing circuit as appropriate.

2. Access the setup and utilities controls by pressing the Screens button, selecting Utility, and selecting the Monitoring tab.

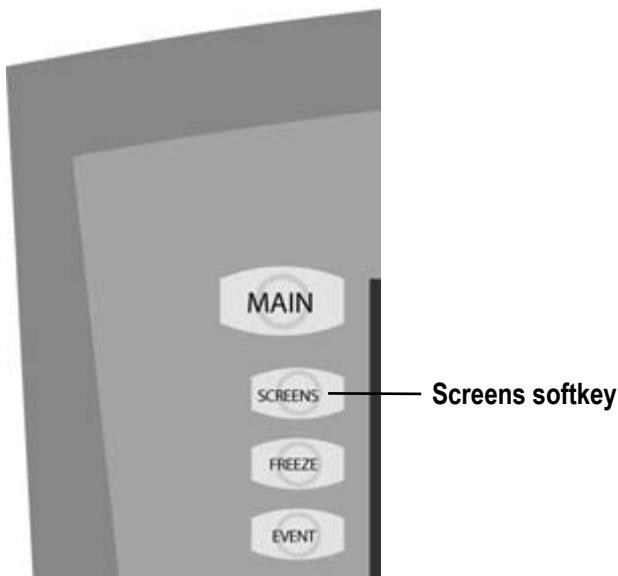

Figure 5–2: Screens softkey

3. Enable CO₂ Monitoring by touching the Enable/Disable button.

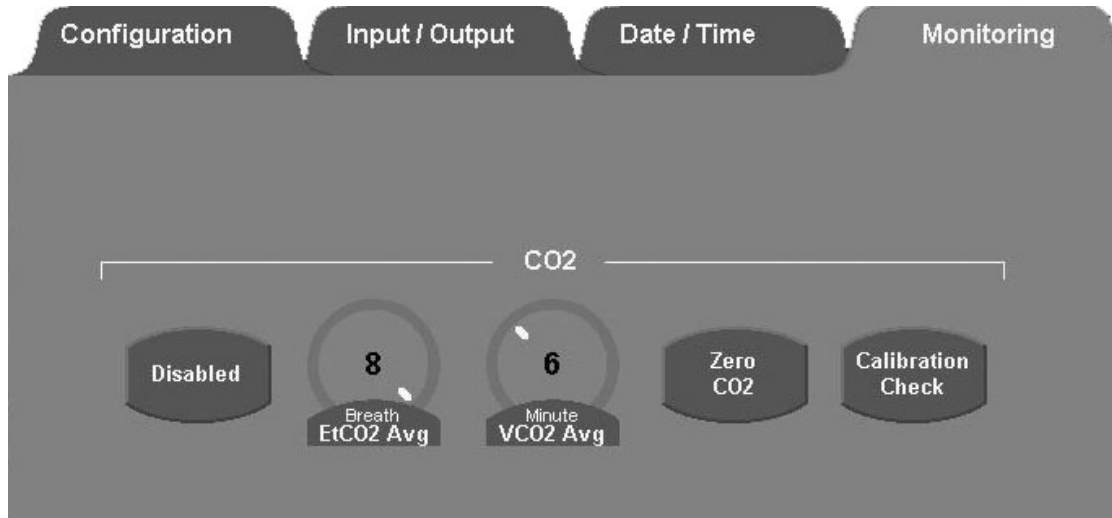

Figure 5–3: Monitoring Tab, Utility Screen

Note:

Capnography requires either a proximal flow sensor or circuit compliance compensation to be active.

If CO₂ monitoring is enabled but a proximal flow sensor or circuit compliance compensation is not active, an alert dialog box appears.



Figure 5–4: Vco2 Alert Dialog

4. If volumetric capnography is required, add a proximal flow sensor or enable circuit compliance compensation (or do both), and then re-enable CO₂ monitoring as described above; otherwise, only the PCO₂ waveform and End-tidal CO₂ monitor are available.
5. Remove the appropriate airway adapter from its packaging and make sure it is undamaged and ready to use.

6. Insert the airway adapter into the CO₂ sensor. The adapter clicks into place when properly inserted.

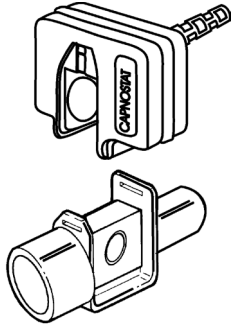

Figure 5.5a Adult / Pediatric Adapter

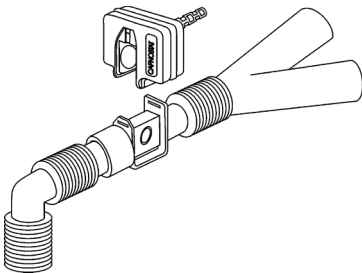

Figure 5.5b Pediatric / Neonatal Adapter

Figure 5–5: Airway adaptors

7. Perform the “sensor zero” procedure by following the instructions in the section “Zeroing the CAPNOSTAT 5” on page 144. The zeroing procedure must also be performed when switching between disposable and reusable airway adapters.
8. After the sensor is successfully zeroed, place the airway adapter and sensor into the ventilator circuit between the wye and endotracheal tube (and any adapters) as shown in the preceding illustration.

Settings and Monitored Values

Settings

The setup and utilities controls are accessed by pressing the Screens button, selecting Utility, and selecting the Monitoring tab.

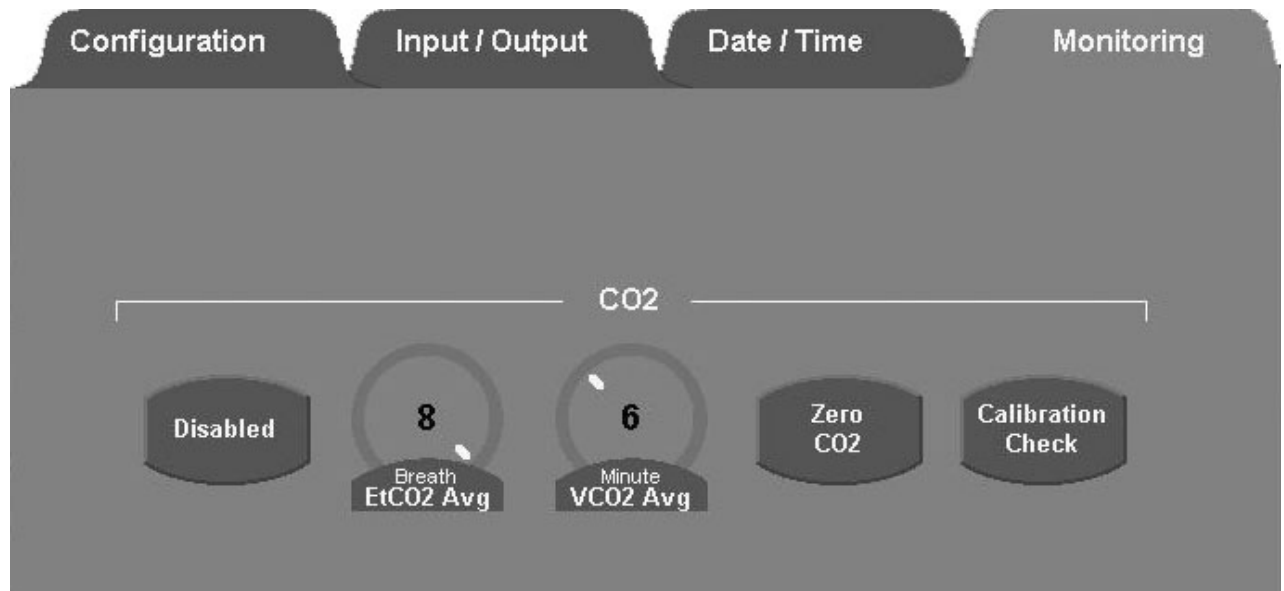

Figure 5–6: Monitoring Tab in Utility Screen

Capnography – Enable / Disable

When CO₂ monitoring is enabled, all CO₂ monitoring and alarm functions are also enabled. When CO₂ Monitoring is disabled all CO₂ monitoring and alarm functions are disabled.

Range: Enable or Disable

Default: Disable

EtCO₂ Averaging

EtCO₂ is measured for each breath. You can select the number of breaths over which the displayed EtCO₂ is averaged.

Range: 1 or 8 breath(s)

Default: 8 breaths

Vco₂ Averaging

Vco₂ is updated at one minute intervals. You select the time over which the displayed Vco₂ is averaged. Also averaged over this time period are Vd, Vd/Vt, VtCO₂ and VA.

Range: 3, 6, 9 or 12 minutes

Default: 6 minutes

Zero CO₂

This control initiates the sensor zero procedure. This procedure needs to be done only when you switch airway adapter types (disposable or reusable) and as part of the calibration check. See the section “Zeroing the CAPNOSTAT 5” on page 144.

Note:

The CO₂ Zero and calibration-check controls are available only when CO₂ is enabled and a sensor has been connected and has completed initialization. This initialization may take up to five seconds.

Calibration Check

This control provides access to a calibration-check procedure. This procedure needs to be done only during the yearly, preventative maintenance procedure. See the section “Checking the Accuracy of the CAPNOSTAT 5” on page 146.

Monitored Values

End Tidal CO₂ (EtCO₂)

The patient's peak expired CO₂ as measured and reported by the CO₂ sensor in the airway. EtCO₂ is measured for each breath. The display is either a breath-by-breath measurement or an averaged measurement.

Range: 0 – 150 mmHg (0 – 20.0 kPa)

Resolution: 0.1 mmHg (0.01 kPa) or three significant digits (whichever is greater)

Accuracy:

± 2 mmHg for 0 – 40 mmHg

± 5% of reading for 41 – 70 mmHg

± 8% of reading for 71 – 100 mmHg

± 10% of reading for 101 – 150 mmHg

Note:

The minimum differential between inspired and expired CO₂ must be 5 mmHg (0.7kPa) or greater.

WARNING!

Do not use EtCO₂ as basis for changing ventilation parameters without reference to clinical condition and independent monitors such as blood gas.

CO₂ Elimination (V_{CO₂})

The amount of CO₂ eliminated every minute. This is calculated over each minute, and then averaged over the set V_{CO₂} averaging time.

Range: 0 – 999 mL/min

Resolution: 0.1 mL or three significant digits (whichever is greater)

CO₂ (VtCO₂)

The amount of CO₂ exhaled per breath. VtCO₂ is measured for each breath and then averaged over the set VCO₂ Averaging time.

Range: 0 – 299 mL

Resolution: 0.1 mL or three significant digits (whichever is greater)

Anatomical Dead Space (Vd ana)

Volume of dead space in the patient's airway. Anatomical dead space is measured for each breath. This value is averaged over the set VCO₂ averaging time.

Range: 0 – 999 mL

Resolution: 0.1 mL or three significant digits (whichever is greater)

Anatomical Dead Space / Tidal Volume Ratio (Vd / Vt ana)

Vd / Vt ana is averaged over the set VCO₂ averaging time.

Range: 0 – 99%

Resolution: 1%

Note:

VCO₂, VtCO₂, Vd ana and Vd/Vt ana require flow to be measured by a proximal flow sensor at the wye, or circuit compliance compensation to be active. If a proximal flow sensor or circuit compliance compensation are not used, the AVEA displays *** in those fields.

Note:

An arterial blood gas sample is required to calculate VA, Vd phy, Vd/Vt phy, Vd alv, OI, and P/F. These values are available at the Capnography Maneuver screen.

Alveolar Ventilation (VA)

Alveolar Ventilation is the volume of gas participating in gas exchange per minute.

Range: 0 – 99.9 L/min

Resolution: 0.01 L/min or three significant digits (whichever is greater)

Physiologic Dead Space (Vd phy)

Range: 0 – 999 mL

Resolution: 0.1 mL or three significant digits (whichever is greater)

Physiologic Dead Space / Tidal Volume Ratio (V_d / V_t phy)

Range: 0 – 99%

Resolution: 1%

Alveolar Dead Space (V_d alv)

Range: 0 – 999 mL

Resolution: 0.1 mL or three significant digits (whichever is greater)

Oxygenation Index (OI)

Oxygenation index is a dimensionless number often used to assess the “pressure cost” of oxygenation.

OI Range: 0 – 200 (when PAO₂ is entered in mmHg); OI Range: 0 – 1500 (when PAO₂ is entered in kPa)

Resolution: 0.1 or three significant digits (whichever is greater)

PaO₂ / FIO₂ Ratio (P/F)

The PAO₂ / FIO₂ ratio is a simple assessment of gas exchange.

Range: 0 – 800 (PAO₂ entered in mmHg) 0 – 106 (PAO₂ entered in kPa)

Resolution: 0.1 or three significant digits (whichever is greater)

Waveforms and Loops**PCO₂ wave (capnogram)**

Displays the CO₂ value through the respiratory cycle as measured and reported by the CO₂ sensor at the wye.

Maximum range: 0 – 150 mmHg (0 – 20 kPa)

PCO₂ / Vte loop

Displays the patient's exhaled CO₂ value on the vertical axis and exhaled Vt on the horizontal axis. During the inspiratory phase, both values will be set to zero.

Maximum range (CO₂): 0 – 150 mmHg (0 – 20 kPa)

Maximum range (Vte): 0 – 2.5 liters

Alarms

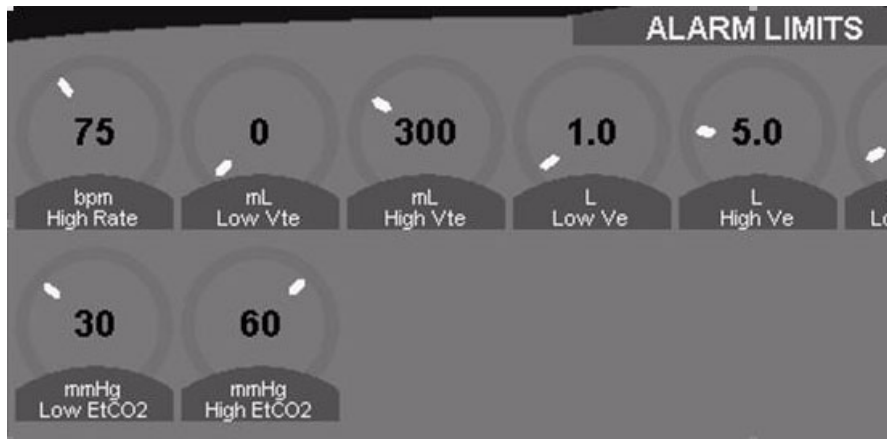

Figure 5-7: Capnometry Alarms

High EtCO₂

Creates a low-priority alarm if the monitored EtCO₂ exceeds this setting (see the previous figure).

Range: 6 to 150 mmHg (0.8 – 20 kPa) or Off

Resolution: 1 mmHg (0.1 kPa)

Default: 60 mmHg (8 kPa)

Note:

The High EtCO₂ alarm must be set at least 5 mmHg (0.7 kPa) above the Low EtCO₂ alarm setting.

Low EtCO₂

Creates a low-priority alarm if the monitored EtCO₂ does not exceed the setting (see the previous figure).

Range: 1 – 145 mmHg (0.1 – 19.3 kPa) or Off

Resolution: 1 mmHg (0.1 kPa)

Default: 30 mmHg (4 kPa)

Note:

The Low EtCO₂ alarm must be set at least 5 mmHg (0.7 kPa) below the High EtCO₂ alarm setting.

Maneuvers

Several additional physiologic parameters (V_d/V_t phy, V_d phy, V_d alv, V_A , O_I and P_F) may be calculated by obtaining P_aCO_2 and P_{aO_2} values at the same time as exhaled CO_2 and volume measurements.

1. Immediately before drawing an arterial blood sample, press the Event button and select Arterial Blood Gas.

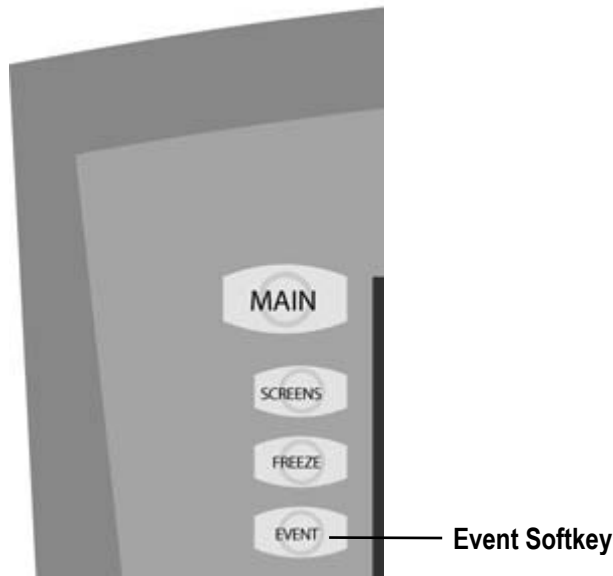

Figure 5–8: Event Softkey

Volume and CO_2 data from the preceding period (set V_{CO_2} Averaging time) are stored.

WARNING!

The patient's cardio-respiratory status should be stable before performing the capnography calculations to ensure the most accurate results.

Note:

If you do not create an Arterial Blood Gas event, no data are stored and no calculations can be performed.

2. After analyzing the arterial sample, press the Screens button, select Maneuvers, and then select Capnometry to display the Capnometry Maneuver screen.
This screen displays data from the last five maneuvers and includes the following:
 - Capnometric data in the digital displays
 - Capnogram
 - Date and time of the arterial blood gas event

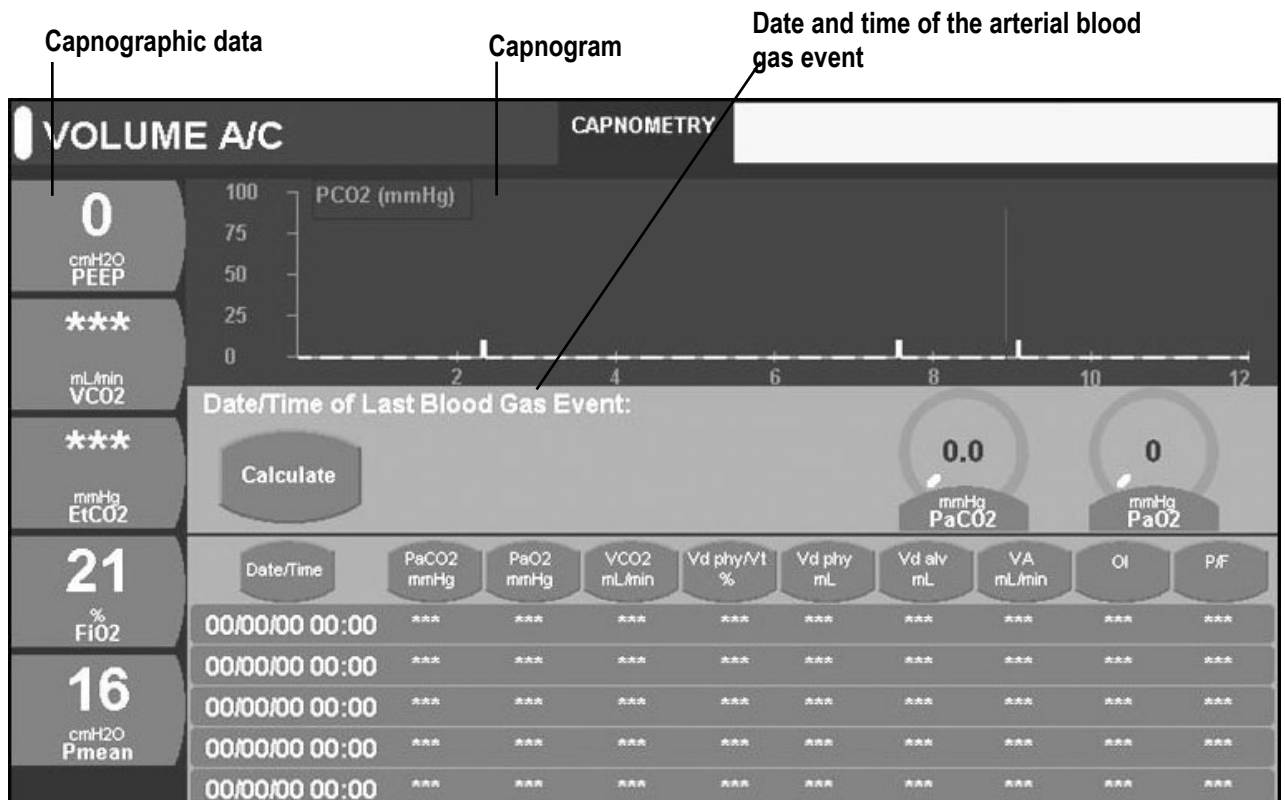

Figure 5-9: Capnometry in Maneuver Screen

When you exit the maneuver screen, the digital displays and waveform return to the original settings.

3. Enter PAO₂ and/or PaCO₂ values using the data dial by touching the appropriate control.

PAO₂ input range: 0-750 mmHg

PaCO₂ input range: 0-250 mmHg

Note:

If you only enter a PCO₂ value, OI and P/F ratio will not be calculated. Likewise, if you only enter a PAO₂ value, the OI and P/F ratio will be the ONLY calculations performed. If you do not enter any arterial blood gas values, or you failed to create an Arterial Blood Gas event, a warning dialog box displays.

4. After you enter the arterial blood gas values, press Calculate.

The screen displays the calculated parameters.

5. Ensure the arterial blood gas values are correct and press Accept.

If you need to make a change, press Cancel and reenter the blood gas values. Once accepted, the new calculations populate the last row on the capnometry maneuver screen.

Zeroing the CAPNOSTAT 5

The CAPNOSTAT 5 must be zeroed when it is connected to the AVEA and monitoring is started. It must also be zeroed to adjust the sensor to the optical characteristics when you change airway adapter types (single patient use or reusable).

WARNING!

Failure to correctly zero the CAPNOSTAT 5 may result in incorrect data being displayed. The airway adapter and CO₂ sensor must not be attached to the patient circuit during the zero procedure.

WARNING!

The airway adapter and CO₂ sensor must not be attached to the patient circuit during the zero procedure.

Note:

The Capnostat must be at operating temperature to be zeroed. If required, the AVEA will wait up to 120 seconds for the sensor to warm up. While the zero procedure is in process, all CO₂ alarms are turned off. The alarms resume when the procedure is complete.

1. Attach the end of the CO₂ sensor cable to the connection on the bottom of the AVEA UIM.



Figure 5–10: Bottom of AVEA UIM

2. Attach the CO₂ sensor to the airway adapter.
3. Access the Capnography Utilities by depressing the Screens soft button, selecting Utility and selecting the Monitoring tab.

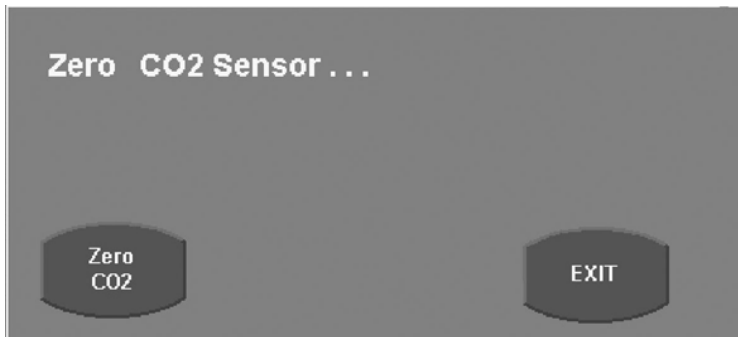

Figure 5–11: Zero CO2 Sensor message

4. Ensure that CO₂ Monitoring is enabled.
5. Press Zero CO₂ and press Continue.
6. If the sensor is ready to zero, a message “Zeroing CO₂ Sensor...” is displayed and a 30 second countdown timer starts.

Note:

If the message “CO₂ Sensor not ready to zero...” is displayed after pressing Continue, a 120 second countdown time starts. The sensor will not be ready to zero if it is not up to its operating temperature, if it detects breaths, or if there is a sensor malfunction. When the sensor becomes ready to zero, “Zeroing CO₂ Sensor...” is displayed and a 30 second countdown timer will start.

7. When the sensor is zeroed, “Zero CO₂ PASS” is displayed.

When the CO₂ sensor sends a Zero Failed message, the timer stops, and a message Zero CO₂ FAIL appears.

When the countdown timer reaches zero without the CO₂ sensor returning a Zero pass or fail, the message Zero CO₂ TIMEOUT displays. Note that in this event, the actual operation of zeroing the sensor may subsequently continue to completion. If this should occur before activation of the Exit control, the message is replaced by Zero CO₂ PASS or Zero CO₂ FAIL, as appropriate.

8. Press Exit to close the message.

It is possible to close the CO₂ Zero Popup while the zero procedure is in progress to provide access to other ventilator functions. In this event, zeroing may then succeed or fail. In the event of failure, the alarm message CO₂ Zero Required displays.

While CO₂ Zeroing is in progress, all CO₂ alarms are disabled. These alarms are reenabled and all CO₂ monitors are restarted upon completion of the zeroing procedure.

Checking the Accuracy of the CAPNOSTAT 5

The accuracy of the CAPNOSTAT 5 sensor should be compared against a calibration gas every twelve months.

1. Attach the end of the CO₂ sensor cable to the connection on the bottom of the AVEA UIM.



Figure 5–12: Bottom of UIM

2. Attach the CO₂ sensor to the airway adapter.
3. Access the Capnography Utilities by depressing the Screens button, selecting Utility, and then selecting the Monitoring tab.

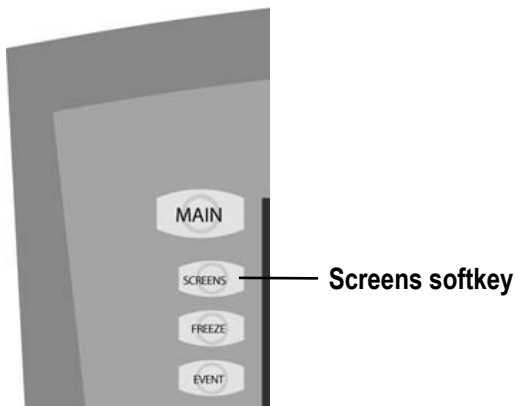

Figure 5–13: Screens Softkey



Figure 5-14: Configuration Tab in Utility Screen

4. Follow the procedure “Zeroing the CAPNOSTAT 5” on page 144. Press Continue when the procedure is complete.
5. Press Calibration Check and then Continue.
6. Set the gas temperature setting to that of the calibration gas (typically room temperature).



Figure 5-15: CO₂ Calibration Message

7. Attach a regulated, flowing gas mixture of 5% CO₂ ($\pm 0.03\%$) balance nitrogen (N₂) to the airway adapter. Set the flow rate of the calibration gas to 2 – 5 liters per minute.
8. Allow 10 seconds for the reading to stabilize. The expected reading is 5% \pm 0.26%.

Note:

While the Calibration Check routine is in process, all CO₂ alarms are suspended. The alarms resume when the procedure is complete.

Chapter 6: Infant Non-invasive Ventilation

Nasal CPAP (nCPAP)

Overview

Infant Nasal CPAP is a spontaneous mode of ventilation. In this mode, no mechanical positive pressure breaths are delivered and no inspiratory triggers are required. A patient spontaneously breathes at an elevated baseline pressure level called the “nCPAP level.”

Note:

Nasal CPAP is an available option in the Infant Mode Select Screen only.

Circuit Compatibility

AVEA nCPAP utilizes standard two-limbed neonate patient circuits and nasal prongs for the patient interface.

The following nasal CPAP prongs have been approved for use:

- HUDSON Infant Nasal CPAP Cannula: Sizes 0 through 4
Hudson RCI, Research Triangle NC
- INCA® Infant Nasal Cannula: Sizes 7.5F, 9F, 10.5F, 12F, 15F
CooperSurgical, Inc., Trumbull CONN
- NEOTECH Binasal Airway: Sizes 3.0 mm, 3.5 mm, 4.0 mm
NEOTECH Products, Inc., Valencia CA
- ARGYLE® Infant Nasal Cannula: Sizes Extra-small, Small, Large
Sherwood Medical; St. Louis MO

General Specifications

nCPAP Level

Range 2 to 10 cmH₂O

Resolution 1 cmH₂O

Default 5 cmH₂O

Accuracy ± 2 cmH₂O

nCPAP Flow

Flow delivery is under software control and limited to a maximum of 15LPM.

Advanced Settings

There are no advanced settings for the primary settings in Nasal CPAP.

Alarms

The Alarms Settings Screen does not open in Nasal CPAP.

Existing machine alarms and safety systems will be maintained. During nCPAP support, certain alarms will be suspended.

Alarms suspended during nCPAP

Time Based Alarms	Volume Based Alarms	Pressure Alarms
High Rate	High Ve	High Ppeak
I-Time Limit	High Vt	Ext High Peak Alarm
I:E Limit	Low Vte	Low PEEP
Apnea Interval	Low Ve	Low Ppeak
	Volume Limit	Occlusion

Alarms added during nCPAP

High nCPAP Pressure

A high priority audible/visual alarm is activated whenever the nCPAP Pressure exceeds the threshold for a period greater than 15 seconds.

Alarm threshold is automatically updated on acceptance of control setting.

Threshold: Set nCPAP level + 3 cmH₂O or Pressure Limit

Low nCPAP Pressure

A high priority audible/visual alarm is activated whenever the nCPAP Pressure falls below the threshold for a period greater than 15 seconds.

Alarm threshold is automatically updated on acceptance of control setting.

Threshold: Set nCPAP level -2 cmH₂O (If nCPAP setting ≥ 3 cmH₂O)

Set nCPAP level -1 cmH₂O (if nCPAP setting < 3 cmH₂O)

nCPAP Pressure Limit

A high priority audible/visual alarm will be activated if the nasal CPAP pressure exceeds 11 cmH₂O for 3 seconds. Upon activation of the alarm, the safety valve will open to ambient. The alarm will deactivate and the safety valve will close when the nCPAP pressure falls below 4.5 cmH₂O.

Initiating Nasal CPAP

1. To initiate Nasal CPAP, touch the Modes membrane button on the UIM or touch the screen area for the Current Mode Display. The Mode Select box appears

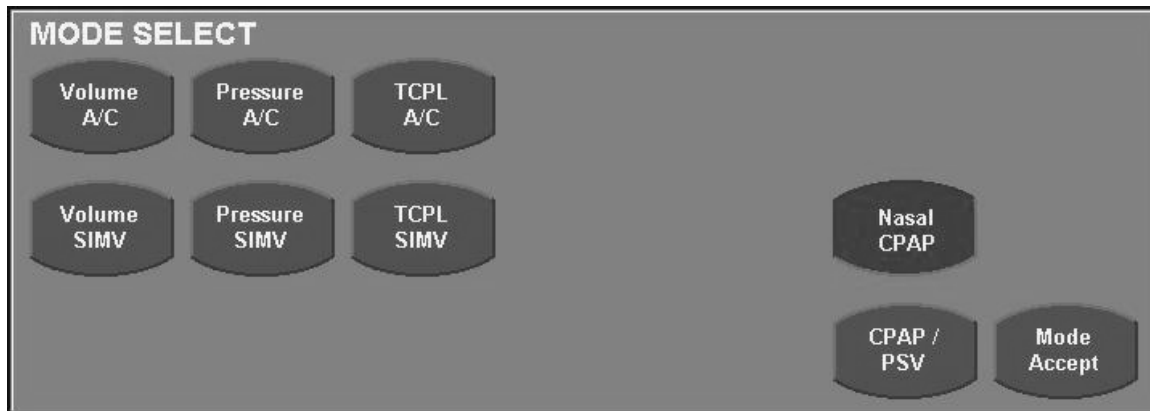

Figure 6-1: Mode selection

2. Touch Nasal CPAP. The following message appears.



Figure 6-2: Calibration Required Message

3. Disconnect the Nasal CPAP device from the patient and disconnect the expiratory limb of the circuit at the patient wye. (Figure 6-3)

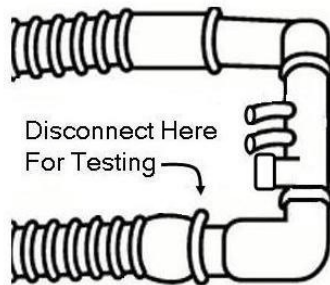

Figure 6-3: Disconnect Point for Calibration

Do not disconnect the Nasal CPAP device at the wye and leave the prongs open to ambient.

4. Touch Continue; the following message appears.

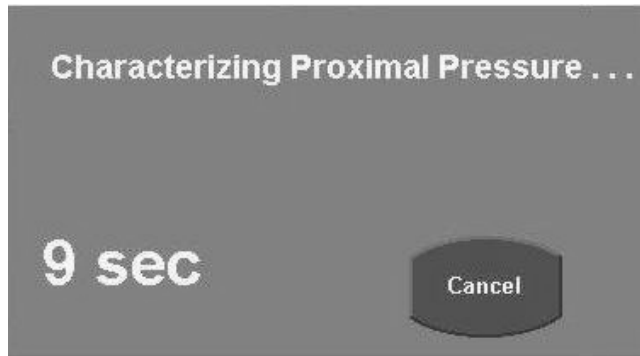

Figure 6-4: Calibration Progress Message

If calibration is successful, the following message appears.

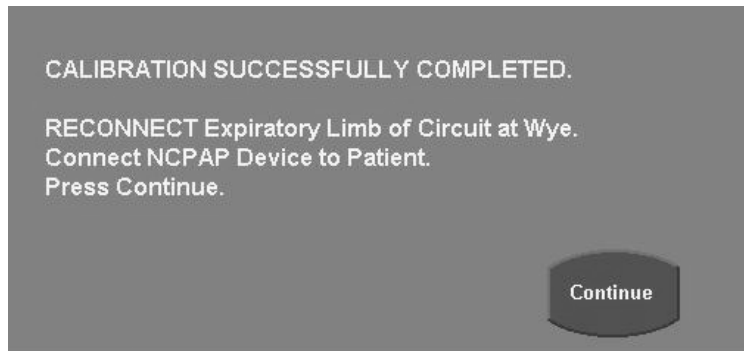

Figure 6-5: Calibration Successfully Completed Screen

Note:

If the calibration test fails, check the following:

- Ensure the patient was disconnected during the calibration.
- Ensure the circuit connections are secure.
- Ensure there was no movement of the circuit during the calibration.
- Ensure the prongs are open during the test.
- Ensure the expiratory limb of the circuit was disconnected before starting the calibration.

If failure of the calibration persists after checking all of the above, remove the ventilator from service and have it checked by a qualified technician.

5. Reconnect the expiratory limb of the circuit at the patient wye.
6. Connect the Nasal CPAP device to the patient and touch Continue. The patient will be supported initially by the default value of 2 cmH₂O of continuous positive airway pressure.
7. Set the prescribed level for nCPAP Pressure and/or FIO₂ by touching the primary control, turning the Data Dial until the desired value is displayed and by either touching the primary control again or by touching the ACCEPT membrane key adjacent to the Data Dial to activate the new setting.

Note:

Low Nasal CPAP Pressure and High Nasal CPAP Pressure Alarm Thresholds are updated automatically when a new value is accepted in the nCPAP Primary Control.



Figure 6-6: nCPAP Primary Controls and Alarm Threshold Indicators

CAUTION!

Apnea back-up ventilation is suspended during nCPAP.

AVEA continually displays the following message during nCPAP administration.

**Non-Invasive Support.
APNEA Backup Disabled.**

Figure 6-7: Caution Message Display

Monitors

In Nasal CPAP, all existing monitors will be suspended, except:

- Air Inlet Pressure (Air Inlet)
- Oxygen Inlet (O₂ Inlet)
- Gas Composition Monitor (FiO₂)
- Percent Leak

The following monitors have been added for Nasal CPAP:

- nCPAP level (mean airway pressure)
 - Range: 0 to 120 cmH₂O
 - Resolution: 1 cmH₂O
 - Accuracy: $\pm 3.5\%$ of reading or ± 2 cmH₂O, whichever is greater
- CPAP Flow (mean inspiratory flow)
 - Range: 0–300 LPM
 - Resolution: 0.1 LPM
 - Accuracy: $\pm 10\%$

Graphics

All existing waves will be maintained except for the volume (Vt) wave will be selectable with no functionality and the loops selection button will be disabled.

Displayed Waves

- Net Flow (Flow)
Range:
Minimum: -2 to +2 LPM
Maximum: -300 to +300 LPM
Default: -40 to +40 LPM
- Inspiratory Flow / CPAP Flow (F_{insp})
Range:
Minimum: -2 to +2 LPM
Maximum: -300 to +300 LPM
Default: -20 to +20 LPM
- Expiratory Flow (F_{exp})
Minimum: -2 to +2 LPM
Maximum: -300 to +300 LPM
- Airway Pressure / CPAP Level (P_{aw})
Minimum: -1 to +2 cmH₂O
Maximum: -60 to +120 cmH₂O
Default: -20 to +40 cmH₂O
- Inspiratory Pressure (P_{INSP})
Minimum: -1 to +2 cmH₂O
Maximum: -60 to +120 cmH₂O

Nasal Intermittent Mandatory Ventilation (nIMV)

Nasal CPAP is a spontaneous mode of ventilation. In this mode, no mechanical positive pressure breaths are delivered.

Nasal IMV is a time-triggered, time-cycled mode of pressure control ventilation provided via nasal prongs. This is an enhancement to the nasal CPAP mode. When a rate is set greater than zero, time-triggered, time-cycled mandatory breaths are delivered. Each breath comprises an inspiratory phase, during which the delivered pressure is increased from baseline (PEEP) to PEEP + Inspiratory Pressure, and an expiratory phase, during which the delivered pressure is returned to PEEP.

Nasal IMV breaths are:

- Controlled by pressure
- Limited by pressure
- Cycled by time

Note:

Nasal CPAP/IMV is only available in the neonatal patient size setting.

Circuit compatibility

This mode utilizes standard two-limbed infant/neonatal patient circuits and nasal prongs for the patient interface.

The following nasal CPAP prongs have been approved for use:

- HUDSON Infant Nasal CPAP Cannula: Sizes 0 through 4
Hudson RCI, Research Triangle NC
- INCA® Infant Nasal Cannula: Sizes 7.5F, 9F, 10.5F, 12F, 15F
CooperSurgical, Inc., Trumbull CONN
- NEOTECH Binasal Airway: Sizes 3.0 mm, 3.5 mm, 4.0 mm
NEOTECH Products, Inc., Valencia CA
- ARGYLE® Infant Nasal Cannula: Sizes Extra-small, Small, Large
Sherwood Medical; St. Louis MO

General specifications

nCPAP Level

Range: 2 to 10 cmH₂O

Resolution: 1 cmH₂O

Default: 5 cmH₂O

Accuracy: ±2 cmH₂O

Insp Press

Range: 0 to 30 cmH₂O

Resolution: 1 cmH₂O

Default: 5 cmH₂O

Accuracy: ±2 cmH₂O

Insp Rise

Range: 1 to 9

(relative control with fast being a setting of 1, and slow a setting of 9)

Default: 5

Note:

Inspiratory Rise is only available when the Rate is set.

Insp Time

Range: 0.15 to 3.0 seconds

Default: 0.35 seconds

Rate

Range: Off, 1 to 80 bpm

Default: Off (nCPAP only)

nCPAP Flow

Flow delivery is under software control and limited to a maximum of 15 LPM.

Advanced Settings

Note:

There are no advanced settings for the primary settings when the Rate is set to Off.

Alarms

Note:

The Alarms Settings window is not available in this mode when the Rate is set to Off. Existing machine alarms and safety systems will be maintained. During nCPAP support with Rate set to Off, certain alarms will be suspended.

Alarms suspended during nCPAP with Rate set to off

Time-based alarms	Volume-based alarms	Pressure alarms
High Rate	High Ve	High Ppeak
I-Time Limit	High Vt	Ext High Peak Alarm
I:E Limit	Low Vte	Low PEEP
Apnea Interval	Low Ve	Low Ppeak
	Volume Limit	Occlusion

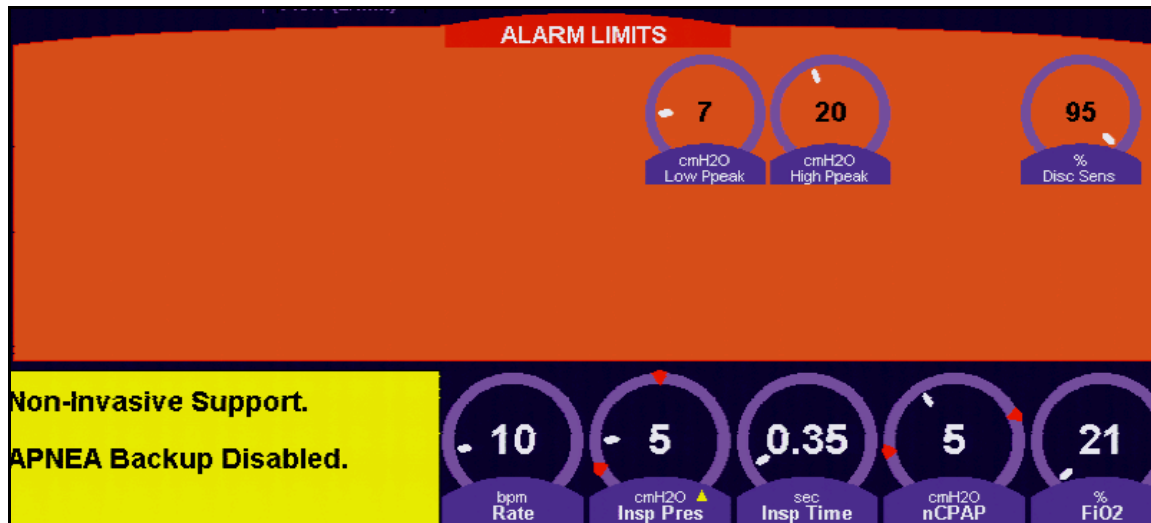

Low Ppeak

Range: 1 to 40 cmH₂O (Neonate setting – nCPAP / IMV)

Default: 7 cmH₂O

Note:

Not available in nasal CPAP mode unless Rate of one or greater is set.

Alarm threshold setting changes during nCPAP / IMV will not be retained for other ventilation modes following exiting from nasal CPAP mode.

High Ppeak

Range: 2 to 45 cmH₂O (Neonate setting – nCPAP / IMV)

Default: 20 cmH₂O

Note:

Not available in nasal CPAP mode unless a Rate of one or greater is set.

Alarm threshold setting changes during nCPAP / IMV will not be retained for other ventilation modes following exiting from nasal CPAP mode.

nCPAP/IMV Disconnect Sensitivity

In nCPAP/IMV, patient circuit disconnect is based on characterization of the nasal prongs, carried out during the nCPAP breathing circuit characterization.

In nCPAP/IMV, the CIRCUIT DISCONNECT alarm is based on leak flow during exhalation (periods of baseline pressure). The circuit characterization provides a value for leak flow with the prongs removed from the nose. An alarm will be indicated if, the leak flow exceeds an operator set percentage of this characterized leak flow. This alarm will activate within 15 seconds of disconnect.

Range: 20 – 95 %

Resolution: 5%

Default: 95 %



The Disconnect Sensitivity setting banner appears in the message bar. The current measured leak is displayed on the left side of the banner and the Disconnect Sensitivity setting is displayed on the right. The background colors illustrate leak in blue relative to the Disconnect Sensitivity setting.

Following completion of Nasal CPAP / IMV characterization procedure, note the measured leak percentage. While the nasal prongs are still disconnected, set the Disconnect Sensitivity slightly below the measured leak percentage. This will help with proper disconnect detection, especially when using small prongs.

Note:

The Disconnect Sensitivity alarm is only available when a Rate of one or greater is set.

If the measured leak is within 5% of the Disconnect Sensitivity setting, the measured leak value will be displayed in RED alerting the operator to an impending alarm.



When the Circuit Disconnect alarm is asserted, the Disconnect Sensitivity setting banner background will display the leak level above the Disconnect Sensitivity setting in RED until the alarm situation is resolved.

Note:

The Leak % monitor is not available in nCPAP/nIMV.

WARNING!

Under certain conditions, such as small prongs and/or high respiratory rates, the Circuit Disconnect Alarm may not recognize that the prongs have been dislodged from the nares during nCPAP or nIMV. Ensure proper physiologic monitoring is used.

High nCPAP pressure

A high priority audible/visual alarm will be activated whenever the nCPAP exceeds the high airway pressure threshold for a period greater than 15 seconds.

Threshold: Set CPAP Level + 3 cmH₂O

Tolerance: ± 0.5 cmH₂O

Note:

Threshold is automatically updated upon acceptance of a change in the nCPAP control setting.

Low nCPAP Pressure

A high priority audible/visual alarm will be activated whenever the nCPAP pressure falls below the low airway pressure threshold for a period greater than 15 seconds.

Threshold: Set nCPAP Level - 2 cmH₂O (if set nCPAP ≥ 3 cmH₂O)

Set nCPAP Level - 1 cmH₂O (if set nCPAP < 3 cmH₂O)

Tolerance: ± 0.5 cmH₂O

Note:

Threshold is automatically updated upon acceptance of a change in the nCPAP control setting.

nCPAP Pressure Limit

A high priority audible/visual alarm will be activated whenever the nCPAP pressure is greater than airway pressure limit for 3 seconds. The alarm will deactivate when the nCPAP pressure drops below 4.5 cmH₂O.

Pressure Limit: 11 cmH₂O (nCPAP only, rate set to off)

Set CPAP Level + Inspiratory Pressure + 3 cmH₂O (nCPAP / IMV, rate not zero)

Tolerance: + 0.5 cmH₂O

Initiating Nasal CPAP / NIMV

1. To initiate Nasal CPAP, select the Modes membrane button on the UIM, or touch the screen area for the Current Mode Display. The Mode Select box appears.

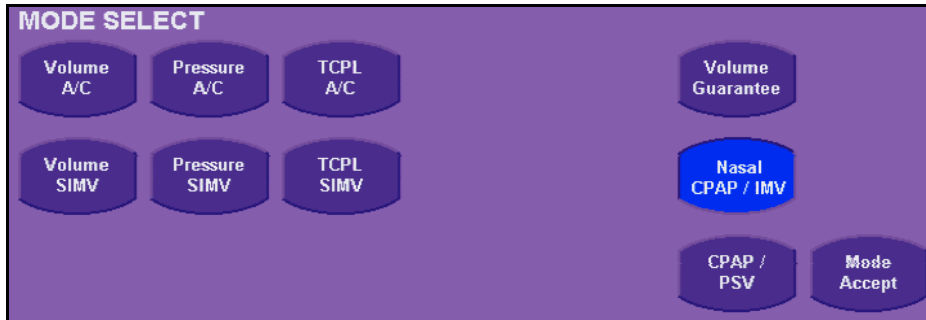

2. Select Nasal CPAP/nIMV. The following message appears.

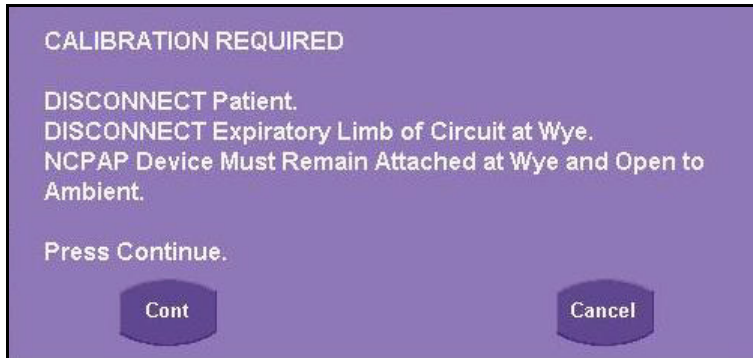

3. Disconnect the Nasal CPAP device from the patient and disconnect the expiratory limb of the circuit at the patient wye.

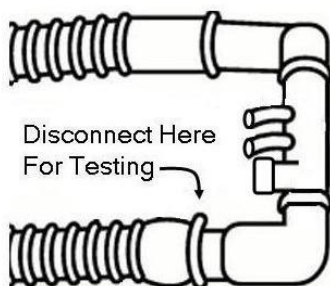

Do not disconnect the Nasal CPAP device at the wye and leave the prongs open to ambient.

4. Touch Continue; the following message appears.

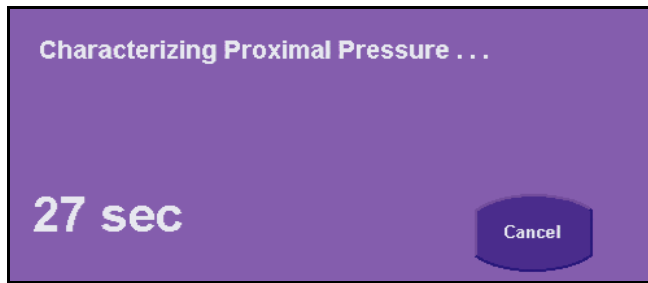

If the calibration is successful, the following message appears.

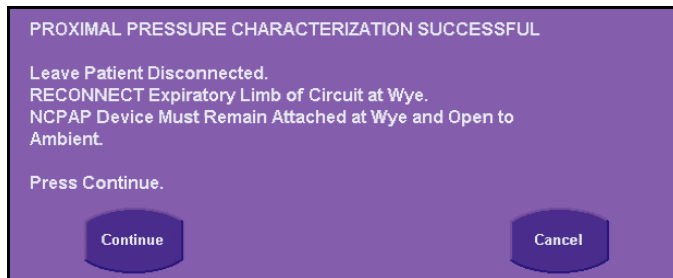

Note:

If the calibration test fails, check the following:

- **Ensure the patient was disconnected during the calibration.**
 1. **Ensure the circuit connections are secure.**
 2. **Ensure there was no movement of the circuit during the calibration.**
 3. **Ensure the prongs are open during the test.**
 4. **Ensure the expiratory limb of the circuit was disconnected before starting the calibration.**

If failure of the calibration persists after checking all of the above, remove the ventilator from service and have it checked by a qualified technician.

5. Leave the patient disconnected and reconnect the expiratory limb of the circuit at the patient wye.

6. Select Continue; the following message appears

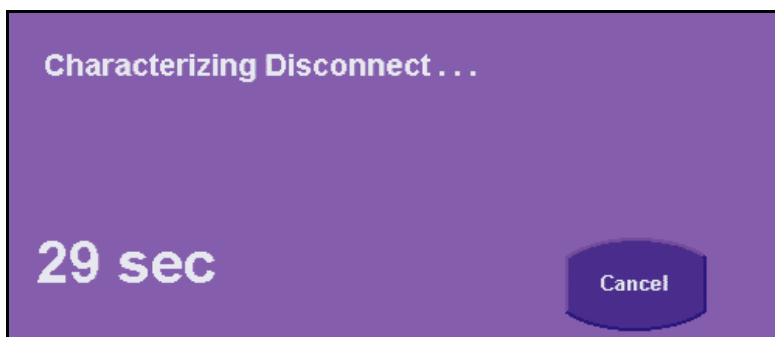

7. If characterization is successful the following message appears

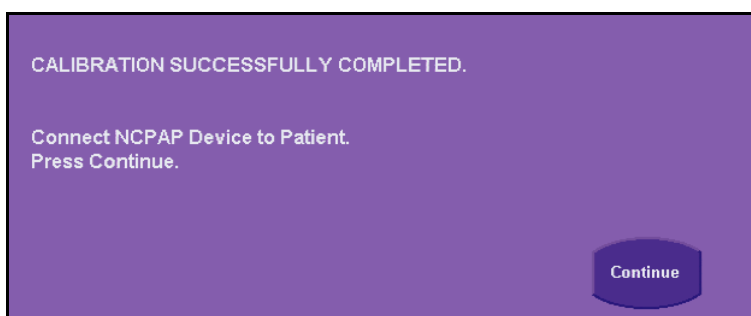

8. Select Continue.
9. Set the prescribed level for nCPAP Pressure and/or FI_{O_2} by touching the primary control, turning the Data Dial until the desired value is displayed and by either touching the primary control again or by touching the ACCEPT membrane key adjacent to the Data Dial to activate the new setting. If NIMV is prescribed, set the prescribed level for Inspiratory Pressure, Inspiratory Time and Rate as well.
10. Connect the Nasal CPAP device to the patient.



Monitors

In Nasal CPAP, all existing monitors will be suspended, except:

- **Air Inlet Pressure (Air Inlet)**
- **Oxygen Inlet (O₂ Inlet)**
- **Gas Composition Monitor (FIO₂)**

The following monitors are only available when the Rate is set to one or greater:

- **Total Breath Rate**
- **Mandatory Breath Rate**
- **Inspiratory Time**
- **Exhalation Time**
- **I:E Ratio**
- **Peak Inspiratory Pressure**
- **Mean Airway Pressure**
- **PEEP**

Nasal CPAP specific monitors

In nCPAP/IMV and when a rate of one or greater is set, the nCPAP level is calculated only over those periods when control pressure is equal to the nCPAP setting (exhalation, following the end of the pressure decay as determined by inspiratory rise control).

- **nCPAP level**
Range: 0 to 120 cmH₂O
Resolution: 1 cmH₂O
Accuracy: $\pm 3.5\%$ of reading or ± 2 cmH₂O, whichever is greater
- **CPAP Flow (mean inspiratory flow)**
Range: 0–300 LPM
Resolution: 0.1 LPM
Accuracy: $\pm 10\%$

Graphics

All existing waveforms will be maintained, except for the volume (Vt) waveform. The volume waveform will be selectable with no functionality, and the loops selection button will be disabled.

Displayed waveforms

- **Net Flow (Flow)**
Range:
Minimum: -2 to +2 LPM
Maximum: -300 to +300 LPM
Default: -40 to +40 LPM
- **Inspiratory Flow / CPAP Flow (Finsp)**
Range:
Minimum: -2 to +2 LPM
Maximum: -300 to +300 LPM
Default: -20 to +20 LPM
- **Expiratory Flow (Fexp)**
Minimum: -2 to +2 LPM
Maximum: -300 to +300 LPM
- **Airway Pressure / CPAP Level (Paw)**
Minimum: -1 to +2 cmH₂O
Maximum: -60 to +120 cmH₂O
Default: -20 to +40 cmH₂O
- **Inspiratory Pressure (PINSP)**
Minimum: -1 to +2 cmH₂O
Maximum: -60 to +120 cmH₂O

Messages

AVEA® message bar text	Cause
Characterization is Required in Nasal CPAP.	Mode Key pressed when nasal CPAP characterization is in progress.
No Advanced Settings in Nasal CPAP.	Advanced Settings Screen Button was pressed with Breath Rate off
No Alarm Limits in Nasal CPAP.	Alarm Limits Screen Button was pressed with Breath Rate off
No Manual Breath in Nasal CPAP.	Manual Breath Button was pressed.
Nasal CPAP / IMV mode: I:E ratio not in range	I:E ratio exceeds I:E ratio limit. The setting will not be accepted.
No Proximal Flow Sensing in nCPAP.	On detection of a Proximal Flow Sensor in Nasal CPAP Mode.

Troubleshooting

Alarm	Priority	Possible causes	Actions
NCPAP Pressure Limit	High	Occlusion of expiratory limb of patient circuit. Occluded expiratory filter	Check expiratory limb for kinks and/or water Replace expiratory filter
Low NCPAP Pressure	High	Circuit disconnect Circuit leak Patient interface leak	Check circuit Check the nasal prongs
High NCPAP Pressure	High	Patient circuit occlusion Water in circuit Patient interaction	Check patient circuit Check nasal prongs
LOW P _{PEAK}	High	Partial or complete disconnect Circuit leak Patient interface leak	Check patient circuit Check nasal prongs
HIGH P _{PEAK}	High	Partial or complete occlusion of circuit Water in circuit Patient cough / sneeze	Check patient circuit Check nasal prongs
Circuit Disconnect	High	Patient circuit disconnect	Check patient circuit

This page intentionally left blank.

Chapter 7: Alarms and Indicators

Status Indicators

The ventilator displays the following status indicators.

Compressor Active



If the internal compressor is active, the **Compressor Active** icon shown here will display at the bottom of the touch screen with no accompanying tone.

Heliox Source Connected



If Heliox gas is connected this green icon displays in bottom right of the touch screen.

Mains/Battery Indicators

There are visual status indicators on the ventilator front panel for the mains power and the internal and external batteries (Figure 7-1).

The sequence in which the power sources are used by the ventilator is:

- Mains AC Power
- External Battery (if installed)
- Internal Battery

Power On Indicator

The green Power On indicator lights up whenever the power switch is on (I) and power is being supplied from any of the available power sources (AC, external battery, or internal battery).

On battery indicator while operating on internal or external battery, a battery icon will blink in the lower right hand corner of the display.

AC Power Indicator

The green AC indicator is on whenever the ventilator is connected to AC power. **It displays whether the power switch is on (I) or off (O).**

Operating On Battery Indicator

When operating on battery power (Internal or External) a yellow blinking battery indicator will appear in the lower right hand corner of the LCD screen.

External Battery Power Indicator

The **EXT** indicator above the battery status indicators is lit whenever the external battery is providing the primary source of power for the ventilator.

Internal Battery Power Indicator

The INT indicator above the battery status indicators is lit whenever the internal battery is providing the primary source of power for the ventilator.

Battery Status Indicators

The battery status indicator shown in Figure 7–1 for the INTERNAL or optional EXTERNAL battery will illuminate incrementally depending on the available charge remaining in the battery.

Note:

If the ventilator is plugged into the mains power supply and no battery status light is illuminated for the internal battery or optional external battery (if equipped), the battery should be checked and/or replaced. Replacement of the Internal battery must be done by a CareFusion trained technician.

LED Indicator	Internal Battery (NiMH)	External Battery (SLA)
GREEN	At least 90% charge remaining	At least 80% charge remaining
YELLOW	Between 30% and 90% remaining	Between 20% and 80% remaining
RED	Less than 30% charge remaining	Less than 20% charge remaining

Note:

When approximately 2 minutes of battery charge remain the ventilator will initiate a non-cancelable alarm. The ventilator should be immediately connected to an appropriate AC power source.

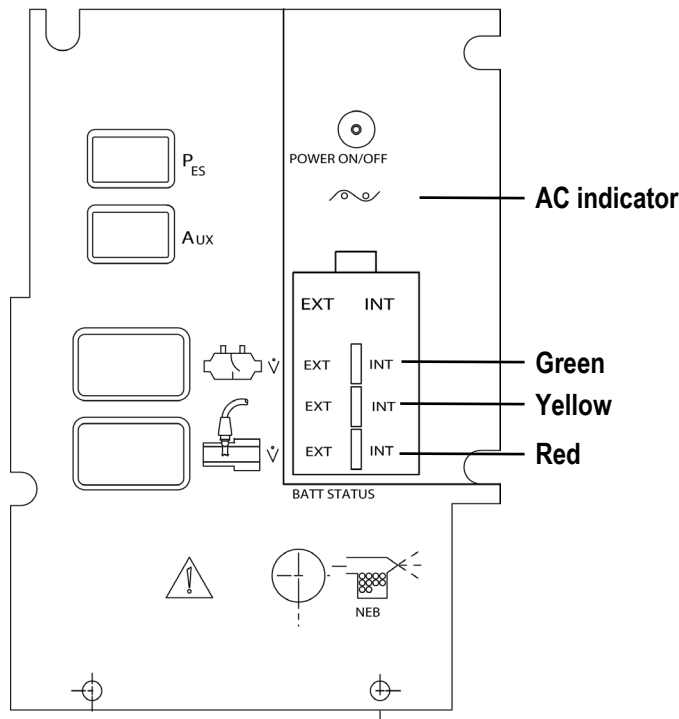

Figure 7–1: Front Panel Display Area. Comprehensive model shown.

Messages

The AVEA displays messages in one of two ways.

- In a “Popup” message box
- In the Message bar at the bottom right of the touch screen

Alert Messages that require an acknowledgement from the user, appear in a “pop-up” message box with an “OK” or “Continue” button. When you press the acknowledgement button, the message disappears and the ventilator continues normal functioning.

“Popup” Alert Messages

These messages will require you to press a button to clear the “Popup” box.

- **Can't change Mode to APRV / BiPhasic when ILV is active.**
- **Can't set Pres Low higher than Pres High.**
- **Can't set Pres High lower than Pres Low.**
- **Stored Settings and Configuration Data lost.**
- **Settings restored to defaults. Check Barometric Pressure setting**
- **Stored Settings lost. Settings restored to defaults.**
- **Stored Configuration Data lost. Check Barometric Pressure setting**
- **Can't change size to PED or ADULT when Mode is TCPL.**
- **Can't change size to NEO when Mode is PRVC.**
- **Can't change size to NEO when Mode is APRV / BiPhasic.**
- **Can't change patient size when Machine Volume is active.**
- **ILV is not available when Mode is APRV / BiPhasic.**
- **Can't disable O₂ Alarms when Heliox is in use.**
- **Ppeak > 90cmH₂O**
- **Barometric pressure calibration invalid. Call service representative. Using 760mmHg.**

The Message Bar

Messages not requiring acknowledgement or response appear in the Message Bar located at the bottom right of the touch screen. A complete list of text, with explanations, for those messages that appear in the message bar, is provided in Appendix F.

Alarms

Alarm Categories

AVEA ventilator alarms are grouped into three categories:

High priority (warning)

This category of alarm requires immediate action. For a high priority alarm, the alarm indicator is **RED** and the alarm icon flashes at a rate of 2 Hz (fast). A high priority alarm sounds a series of **five tones**, three low and two high, repeated at intervals of 6 seconds.

Medium priority (caution)

A medium priority alarm displays a **yellow** indicator and the alarm icon flashes at ½ Hz (slow). A medium priority alarm sounds **three tones**, all at the same pitch, repeated at intervals of 20 seconds.

Low priority (advisory)

A low priority alarm (or advisory) displays a **yellow** indicator and the alarm icon does not flash.

A low priority alarm sounds a **single tone**, which is not repeated

There are visual displays for all categories of alarms. A text message appears in the indicator at the upper right of the touch screen.

The alarm icons flash until the cause of the alarm is no longer present. Both high and medium priority alarms that have been resolved will appear as a solid yellow message indicator with no icon displayed until the Alarm Reset button is pressed. (See Table 7–1 on page 178 for alarm messages.)

Multiple alarms can be displayed simultaneously. If 2 or more alarms are current, a white triangle appears on the right of the alarm indicator/message. Touching the screen over the triangle will open a drop down box for display of up to nine alarm messages. In the event that there are more than nine active or resolved alarms available for display, the nine highest priority alarms will be displayed.

To close the drop down box and display a single alarm message, touch the triangle again.

Alarm messages are prioritized in order of appearance, the highest priority alarm is always displayed in the top position of the alarm indicator display.

The alarm indicator is solid green with no message when no alarms are currently active.

Backup Alarm (advisory)

- A continuous tone alarm sounds when a vent-inop occurs and the Back Up Alarm electronics detects the primary alarm is not functioning.

Alarm Controls

Setting an Alarm Limit

To set the limits for each alarm, press the red Alarm LIMITS membrane button on the right of the user interface marked with the icon shown here.



The Alarm Limits screen will appear (Figure 7-2). To set the limits for an alarm, press the touch screen immediately over the alarm control. The control will highlight (change color) on the screen.

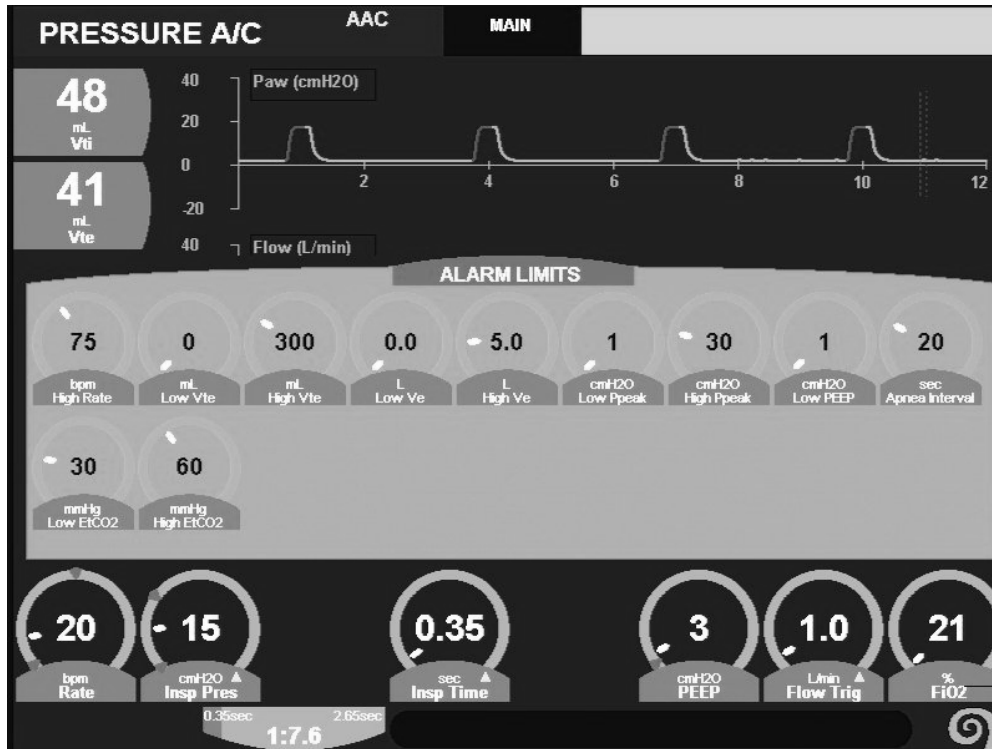

Figure 7-2: Alarm Limits Screen

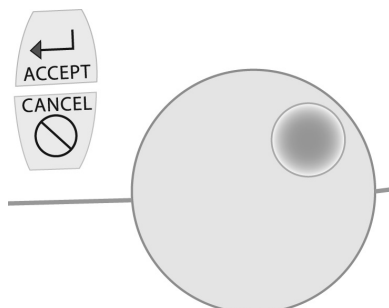

Figure 7-3: Control Knob and Accept / Cancel Softkeys

With the control selected, rotate the large data dial below the touch screen until the control reaches the setting you require. To accept the new setting, either press the touch screen over the control again or press the ACCEPT button.

Note:

Red indicators appearing on the primary controls display the relative alarm settings of any associated alarm.

Alarm Silence

You can disable the audible alarm for 2 minutes \pm 1 second by pressing the Alarm Silence key. Pressing the Alarm Silence key again before the 2-minute period is up will cancel the "silence". This feature is functional for all alarms, with the exception of the "Vent Inop" alarm, which cannot be silenced.

Note:

The activation of the auditory alarm silence button will not prevent the subsequent activation of auditory alarm signals for certain alarm conditions.

Alarm Reset

The Alarm Reset button deactivates visual indicators for alarms that are no longer active.

Alarm Types

Machine Alarms

Safety Valve Open

This is a high priority audible/visual alarm. **SAFETY VALVE OPEN** is displayed, and a high priority tone sounds whenever the Safety Valve is open.

Ventilator Inoperative

This is a high priority audible/visual alarm. **VENT INOP** is displayed if the ventilator fails due to a non-recoverable condition, such as loss of power or supply gases. A high priority tone sounds. The safety valve opens, indicated by a **SAFETY VALVE OPEN** alarm message, and the patient is allowed to breathe room air.

Note:

PEEP is not maintained during a VENT INOP or a SAFETY VALVE OPEN alarm condition. When the ventilator safety valve is open the ventilator graphics will indicate a safety state by displaying the color **purple**.

Not Ventilating

This is a high priority audible/visual alarm. **NOT VENTILATING** is displayed if the internal blended system pressure drops below 1 psi for greater than about 12 seconds. The time delay on this alarm allows a transient drop in pressure due to high patient demand. This alarm is triggered when there is a component failure that is preventing ventilation from occurring. The Safety Valve is normally held physically closed by this system pressure, and therefore the safety valve should be open if there is no system pressure at this location to keep the Safety Valve closed. This alarm is differentiated from "Safety Valve Open", as the software is not driving the Safety Valve to an open state, and the

software cannot determine the physical state of the Safety Valve. This is a local alarm only and is not transmitted via any communication protocol, however other alarms should always be active and transmitted; the primary purpose of this new alarm message is to provide clarification and differentiation from “Circuit Disconnect” to alert the operator that there is a potential machine fault.

The first thing the operator should check for is a compressed gas source. If the “Not Ventilating” message is displayed without an accompanying “Loss of Gas” alarm, the unit should be removed from service.

Fan Failure

This is a low priority audible/visual alarm. **FAN FAILURE** is displayed and low priority tone sounds, whenever the circulating fan at the rear of the ventilator cabinet stops rotating.

Circuit Disconnect Alarm

This is a high priority audible / visual alarm. The ventilator will sound a disconnect alarm when total expiratory flow, inclusive of bias flow is less than 10% of total inspiratory flow, inclusive of bias flow for 5 seconds. Additionally, in neonatal applications when a proximal flow sensor is used the circuit disconnect is sounded when the Percent Leak $((V_{ti} - V_{te}) / V_{ti})$ is greater than 95% for three consecutive breaths.

If “Loss of Gas” or “Not Ventilating” alarms are active in addition to a “Circuit Disconnect” alarm, the trigger for these alarms is a loss of system pressure, not a circuit leak or circuit disconnect. See “Loss of Gas Supply” on page 173 and “Not Ventilating” on page 172 for details and resolution of these conditions.

Note:

While the circuit disconnect alarm is active, the ventilator will stop cycling and set a bias flow. The ventilator will automatically detect the patient upon reconnection and resume normal ventilation.

The apnea interval timer is suspended during a Patient Circuit Disconnect Alarm.

Setting extremely small delivered tidal volumes with Circuit Compliance Compensation not active and using a proximal flow sensor may result in assertion of Patient Circuit Disconnect Alarms.

Gas Supply Indicators and Alarms

Loss of Air

This is a high priority audible/visual alarm. **LOSS, AIR** is displayed and a high priority tone sounds. This alarm is triggered if the wall air supply to the ventilator drops below 18.0 psig (1.2 bar), and the ventilator does not have a functional internal compressor or the compressor output is insufficient to meet instrument demand. The patient continues to be ventilated by the oxygen supply only.

Loss of O₂

This is a high priority audible/visual alarm. **LOSS, O₂** is displayed and a high priority tone sounds. This alarm is triggered if the oxygen supply to the ventilator drops below 18.0 psig (1.2 bar) and the % O₂ control is set >21%. The patient continues to be ventilated by the air supply (wall air or internal compressor) only.

Loss of Gas Supply

This is a high priority audible/visual alarm. **LOSS, GAS SUPPLY** is displayed and a high priority tone sounds. This alarm is triggered if the ventilator loses all sources of gas (wall air, internal compressor if present, and wall oxygen). The safety valve opens, indicated by a **SAFETY VALVE OPEN** visual display, and the patient is allowed to breathe room air.

Note:

PEEP is not maintained during a LOSS, GAS SUPPLY alarm condition. When the ventilator safety valve is open the ventilator graphics will indicate a safety state by displaying the color **purple**.

Loss of Heliox

This is a high priority audible/visual alarm. **LOSS, HELIOX** is displayed and a high priority tone sounds. The alarm is triggered if Heliox is being used and the Heliox supply to the ventilator drops below 18.0 psig (1.2 bar). The patient continues to be ventilated by the oxygen supply only.

Pressure Alarms**Low Peak Pressure**

This is a high priority audible/visual alarm. **LOW P_{PEAK}** is displayed and a high priority tone sounds, whenever the peak inspiratory pressure for a given breath is less than the preset threshold for Low P_{PEAK}.

Range: 3 to 99 cmH₂O

Defaults: 8 cmH₂O (Adult/Pediatric)
5 cmH₂O (Neonate)

Limitations: Not active for spontaneous breaths.

High Peak Pressure

This is a high priority audible/visual alarm. **HIGH P_{PEAK}** is displayed and a high priority tone sounds whenever the preset High P_{PEAK} threshold is exceeded. Inspiration is terminated and circuit pressure is allowed to return to the current set baseline pressure + 5 cmH₂O. Circuit pressure must return to baseline +5 cmH₂O before the next breath can be delivered.

- **Normal High P_{PEAK} Alarm**

Alarms if the inspiratory pressure in the patient circuit exceeds the set High P_{PEAK} alarm threshold during the inspiratory phase of a breath, except during sigh breath cycles.

Range: 10 to 105 cmH₂O (Adult/Pediatric)
10 to 85 cmH₂O (Neonate)

Defaults: 40 cmH₂O (Adult/Pediatric)
30 cmH₂O (Neonate)

Not active for Sigh Breaths

- **Sigh High P_{PEAK} Alarm**

Alarms if the inspiratory pressure in the patient circuit exceeds the Sigh High P_{PEAK} alarm threshold during a sigh breath cycle.

Range: 1.5 x (Normal High P_{PEAK}), up to a maximum of 105 cmH₂O

Active only for Sigh Breaths.

Note:**Maximum Circuit Pressure Limit:**

The ventilator has an independent mechanical pressure relief valve, which limits the maximum pressure at the patient wye to 125 cmH₂O.

Extended High Peak Pressure

This is a high priority audible/visual alarm. EXT **HIGH P_{PEAK}**, is displayed and a high priority tone sounds if the High P_{PEAK} alarm remains active for more than 5 seconds, (i.e. the circuit pressure does not return to PEEP + 5 cmH₂O within 5 seconds). **No breaths are delivered during this alarm condition.** The Safety and Exhalation valves open allowing the patient to breathe from room air and the Safety Valve alarm activates. Bias flow is suspended while this alarm is active. PEEP may not be maintained. This alarm remains active (flashing) until the condition causing it has been resolved.

Low PEEP

This is a high priority audible/visual alarm. **LOW PEEP** is displayed and a high priority tone sounds if the baseline pressure (PEEP) is less than the Low PEEP alarm threshold for a period greater than 0.25 ± 0.05 seconds.

Range: 0 to 60 cmH₂O

Defaults: 3 cmH₂O (Adult/Pediatric)

1 cmH₂O (Neonate)

The alarm is off if set to zero.

Circuit Occlusion Alarm

This is a high priority audible/visual alarm. CIRCUIT OCCLUSION is displayed and a high priority tone sounds whenever the inspiratory or expiratory limb of the patient circuit becomes sufficiently occluded to trigger the alarm. An inspiratory limb occlusion is unlikely to cause any pressure increase at the patient and will simply result in the termination of the breath.

The system is designed to prevent an expiratory limb occlusion from causing an increase in patient pressure measured at the distal end of the ET tube beyond the following limits:

- For Neonates: 5 cmH₂O or 15% (whichever is greater) above the target pressure
- For Adults/Pediatrics: 10 cmH₂O or 15% (whichever is greater) above the target pressure

Bias flow is suspended while the alarm is active, and the alarm is deactivated when the occlusion is removed.

Note:

High patient-circuit resistance may cause false circuit-occlusion alarms. False circuit-occlusion alarms may also occur when peak inspiratory flow exceeds 150 L/min for adult, 75 L/min for pediatrics, and 30 L/min for neonates. For the recommended test for neonatal-circuit resistance, refer to “Appendix E: Sensor Specifications & Circuit Resistance” on page 217.

The alarm is not active in nCPAP mode.

Note:

The ventilator may assert a circuit occlusion alarm in conditions when measured PEEP is significantly greater than operator set PEEP.

Volume Alarms

Low Exhaled Minute Volume (Low V_e)

This is a high priority audible/visual alarm. **LOW MINUTE VOLUME** is displayed and a high priority tone sounds whenever the monitored exhaled minute volume is less than the Low Exhaled Minute Volume threshold setting.

Range: Off (indicated by 0), 1 to 50 L (Adult)
 Off (indicated by 0), 0.1 to 30.0 L (Pediatric)
 Off (indicated by 0), 0.01 to 5.00 L (Neonate)

Defaults: 1.00 Liter (Adults)
 0.50 Liter (Pediatrics)
 0.05 Liter (Neonate)

High Exhaled Minute Volume (High V_e)

This is a medium priority audible/visual alarm. **HIGH MINUTE VOLUME** is displayed and a medium priority tone sounds whenever the monitored exhaled minute volume is greater than the High Exhaled Minute Volume threshold setting.

Range: 0 to 75 L (Adult)
 0.0 to 30.0 L (Pediatric)
 0.00 to 5.00 L (Neonate)

Defaults: 30.0 L (Adult/Pediatric)
 5.00 L (Neonate)

Low Exhaled Tidal Volume (Low V_t)

A high priority audible/visual alarm shall be activated, and **LOW TIDAL VOLUME** shall be indicated, whenever the absolute monitored exhaled tidal volume does not exceed the Low Tidal Volume alarm threshold setting for the Low V_t Sensitivity setting.

Range: Off (indicated by 0.00) to 3.00 L (Adult)
 Off (indicated by 0) to 1000 mL (Pediatric)
 Off (indicated by 0.0) to 300.0 mL (Neonate)

Resolution: 0.01 L (Adult)
 1 mL (Pediatric)
 0.1 mL (Neonate)

Accuracy: ± 0.01 L of monitored exhaled tidal volume (Adult)
 ± 1 mL of monitored exhaled tidal volume (Pediatric)
 ± 0.1 mL of monitored exhaled tidal volume (Neonate)

Defaults: 0.00 L (Adult)
 0 mL (Pediatric)
 0.0 mL (Neonate)

Note:

The Low Exhaled Tidal Volume alarm will assert on a single occurrence of a low exhaled volume. In patients who have variable tidal volumes, the Low Exhaled Tidal Volume alarm may be turned off (default) and the Low Exhaled Minute Volume alarm can be used to avoid nuisance alarms.

High Tidal Volume (High V_t)

This is a low priority audible/visual alarm.. **HIGH V_t** is displayed and a low priority tone sounds if the absolute monitored exhaled tidal volume is greater than the High Tidal Volume threshold setting.

Range:	0.10 to 3.00 L	(Adult)
	25 to 1000 ml	(Pediatric)
	2.0 to 300.0 ml	(Neonate)
Defaults:	3.00 L	(Adult)
	1000 ml	(Pediatric)
	300.0 ml	(Neonate)

Rate/Time Alarms**Apnea Interval**

This is a high priority audible/visual alarm. **APNEA INTERVAL** is displayed and a high priority tone sounds if the ventilator does not detect a breath initiation (by any means) within the preset period of time. Apnea ventilation will begin when this alarm is activated.

Range:	6 to 60 seconds
Default:	20 seconds

High Rate

This is a medium priority audible/visual alarm. **HIGH RATE** is displayed and a medium priority tone sounds if the monitored total breath rate exceeds the alarm setting.

Range:	1 to 200 bpm
Default:	75 bpm

Maximum Inspiratory Time Limit (Max I-Time)

This is a low priority audible/visual alarm. **I-TIME LIMIT** is displayed and a low priority tone sounds if the inspiratory time for any breath exceeds the maximum set inspiratory time plus pause time. Maximum inspiratory time is 5.0 seconds for adult/pediatric, and 3.0 seconds for neonate. The inspiratory phase of the breath is terminated when this alarm activates.

I:E Ratio Limit (I:E Limit)

This is a low priority audible/visual alarm. **I:E LIMIT** is displayed and a low priority tone sounds, if the I:E Ratio for a mandatory breath exceeds 4:1. The inspiratory phase of the breath is terminated when this alarm activates.

This alarm is not active in APRV / BIPHASIC mode.

O₂ Alarms

Low O₂% (Low FIO₂)

This is a high priority audible/visual alarm. **LOW** FIO₂ is displayed and a high priority tone sounds if the monitored Delivered O₂% falls below the set FIO₂ minus 6% or 18% FIO₂, whichever is greater.

High O₂% (High FIO₂)

This is a high priority audible/visual alarm. **HIGH** FIO₂ is displayed and a high priority tone sounds if the monitored Delivered O₂% rises above the set FIO₂ + 6%.

Table 7–1: Alarm Conditions

Message	Alarm Condition	Range	Priority
SAFETY VALVE OPEN	Safety valve is open	N/A	High
VENT INOP	Ventilator failure due to a recoverable or non-recoverable condition. The safety valve opens, indicated by a SAFETY VALVE message, and the patient is allowed to breathe room air. PEEP is not maintained	N/A	High
LOSS, AIR	Wall air drops below 18.0 psig (1.2 bar) and no functional compressor is installed or the compressor output is insufficient to meet instrument demand. Patient will continue to be ventilated by O ₂ supply only.	N/A	High
LOSS, O₂	Oxygen supply to the ventilator drops below 18.0 psig (1.2 bar) and the %O ₂ is set to > 21%. Patient will continue to be ventilated by the air supply only	N/A	High
LOSS, HELIOX	The alarm is triggered if heliox is being used and the heliox gas supply to the ventilator drops below 18.0 psig (1.2 bar). The patient continues to be ventilated by the oxygen supply only.	N/A	High
LOSS, GAS SUPPLY	All sources of gas fail; wall air, internal compressor (if installed) and oxygen. The safety valve opens, indicated by a SAFETY VALVE OPEN message, and the patient is allowed to breathe room air. PEEP is not maintained.	N/A	High
NOT VENTILATING	The internal blended gas pressure is below 1 psi for greater than about 12 seconds, indicating there is no ventilation occurring. The safety valve should be open in this condition, as there is no pressure to keep the safety valve closed. This alarm is only a monitor of this pressure level and does not change the “state” of the ventilator. The condition is recoverable if pressure is restored.	Pressure < 1psi for > 12 seconds	High
LOW P_{PEAK}	The peak inspiratory pressure for a breath is less than the set LOW P _{PEAK} . Not active for spontaneous breaths.	3 to 99 cmH ₂ O Default 3 cmH ₂ O	High
HIGH P_{PEAK}	Peak inspiratory pressure is greater than the set HIGH P _{PEAK} . Inspiration is terminated and the circuit pressure is allowed to return to baseline pressure + 5 ± 1.5 cmH ₂ O before the next breath is delivered.	Normal Breath Range: Adult: 10 to 105 cmH ₂ O Default: 40 cmH ₂ O Pediatric: 10 to 85 cmH ₂ O Default: 40 cmH ₂ O Neonate: Default: 30 cmH ₂ O Sigh Breath Range: 1.5 x set normal HIGH P _{PEAK} Only active for sigh breaths	High
EXT HIGH P_{PEAK}	Activates whenever the HIGH P _{PEAK} alarm has been active for more than 5 seconds (i.e. If the circuit pressure fails to return to PEEP + 5 cmH ₂ O within 5 seconds). The safety and exhalation	N/A	High

Message	Alarm Condition	Range	Priority
	valves open and no breaths are delivered. The SAFETY VALVE OPEN alarm activates. Bias flow is suspended while this alarm is active. PEEP may not be maintained. This alarm will remain active until the condition is resolved.		
LOW PEEP	Baseline pressure (Positive End Expiratory Pressure) is less than the set LOW PEEP alarm threshold for a period greater than 0.25 ± 0.05 seconds. This alarm is OFF if set to zero.	0 to 60 cmH ₂ O Defaults: 3 cmH ₂ O (Adult/Pediatric) 1 cmH ₂ O (Neonate)	High
LOW Ve	Monitored exhaled minute volume (V _e) is less than the set LOW V _e alarm threshold.	OFF (0), 1 to 50 L (Adult) OFF (0), 0.1 to 30 L (Pediatric) OFF (0), 0.01 to 5.00 L (Neonate) Default OFF	Medium
HIGH Ve	Monitored exhaled minute volume (V _e) is greater than the set HIGH Ve alarm threshold.	0 to 75 L (Adult) 0.0 to 30.0 L (Pediatric) 0.00 to 5.00 L (Neonate) Defaults: 30.0 L (Adult/Pediatric) 5.00 (Neonate)	Medium
HIGH Vt	The absolute monitored exhaled tidal volume is greater than the set HIGH Vt alarm threshold.	0.10 to 3.00 L (Adult) 25 to 1000 ml (Pediatric) 2.0 to 300.0 ml (Neonate) Defaults: 3.00 L (Adult) 1000 ml (Pediatric) 300.0 ml (Neonate)	Visual Alert
Low Vt	The absolute monitored exhaled tidal volume does not exceed the Low Tidal Volume alarm threshold setting	Off to 3.00 L (Adult) Off to 1000 mL (Pediatric) Off to 300.0 mL (Neonate)	High
APNEA INTERVAL	Active in A/C, SIMV, APRV / BIPHASIC and CPAP/PSV modes if the ventilator does not detect a breath within the preset APNEA time interval.	6 to 60 seconds Default 20 seconds	High
HIGH RATE	The monitored total breath rate exceeds the set alarm RATE.	1 to 200 bpm Default: 75 bpm	Medium
I-TIME LIMIT	The inspiratory time for a breath exceeds the set MAX I-TIME plus pause time, which is 5.0 seconds for adult/pediatric patients and 3.0 seconds for neonatal patients.	N/A	Low
I:E LIMIT	The inspiratory: expiratory ratio for a mandatory breath exceeds 4:1. The inspiratory phase of the breath is terminated.	Not active in APRV / BIPHASIC mode.	Low
LOW F_{IO2}	Delivered oxygen percentage falls below the set F _{IO2} minus 6% or 18% F _{IO2} , whichever is greater.	N/A	High
HIGH F_{IO2}	Delivered oxygen percentage rises above the set F _{IO2} plus 6%	N/A	High
CIRCUIT DISCONNECT	A high priority audible/visual alarm is activated, and CIRCUIT DISCONNECT displayed, whenever the patient circuit becomes disconnected from the ventilator or patient.	N/A	High
LOW BATTERY	A high priority audible/visual alarm is activated, and LOW BATTERY displayed, whenever the internal battery has been depleted to a level that provides a minimum of two minutes of safe operation.	N/A	High
LOSS, AC POWER	A high priority audible/visual alarm is, and LOSS, AC POWER displayed, whenever the power switch is on and AC power has been removed from the ventilator (i.e. power cord disconnect or loss of supply power).	N/A	High
ILV DISCONNECT	A high priority audible/visual alarm is activated, and ILV DISCONNECT displayed, whenever the master ventilator	N/A	High

Message	Alarm Condition	Range	Priority
	becomes disconnected from the slave ventilator during ILV.		
INVALID GAS ID	A medium priority audible/visual alarm shall be activated, and INVALID GAS I.D. shall be indicated whenever a defective gas I.D. connector is installed in the ventilator. When a defective Gas I.D. connector is detected, the gas corrections default to air.	N/A	Medium
FAN FAILURE	A low priority audible/visual alarm is activated, and FAN FAILURE indicated, whenever the fan has stopped rotating.	N/A	Low
High EtCO₂	Low priority alarm if monitored EtCO ₂ exceeds the alarm threshold setting.	6 – 150 mmHg or off Default: 60 mmHg	Low
Low EtCO₂	Low priority alarm if monitored EtCO ₂ does not exceed the alarm threshold setting.	1 – 145 mmHg or off Default: 30 mmHg	Low

Nasal CPAP / Nasal IMV Alarms

Note:

The Alarms Settings window is not available in this mode when the Rate is set to Off. Existing machine alarms and safety systems will be maintained. During nCPAP support with Rate set to Off, certain alarms will be suspended.

Alarms suspended during nCPAP with Rate set to off

Time-based alarms	Volume-based alarms	Pressure alarms
High Rate	High Ve	High Ppeak
I-Time Limit	High Vt	Ext High Peak Alarm
I:E Limit	Low Vte	Low PEEP
Apnea Interval	Low Ve	Low Ppeak
	Volume Limit	Occlusion

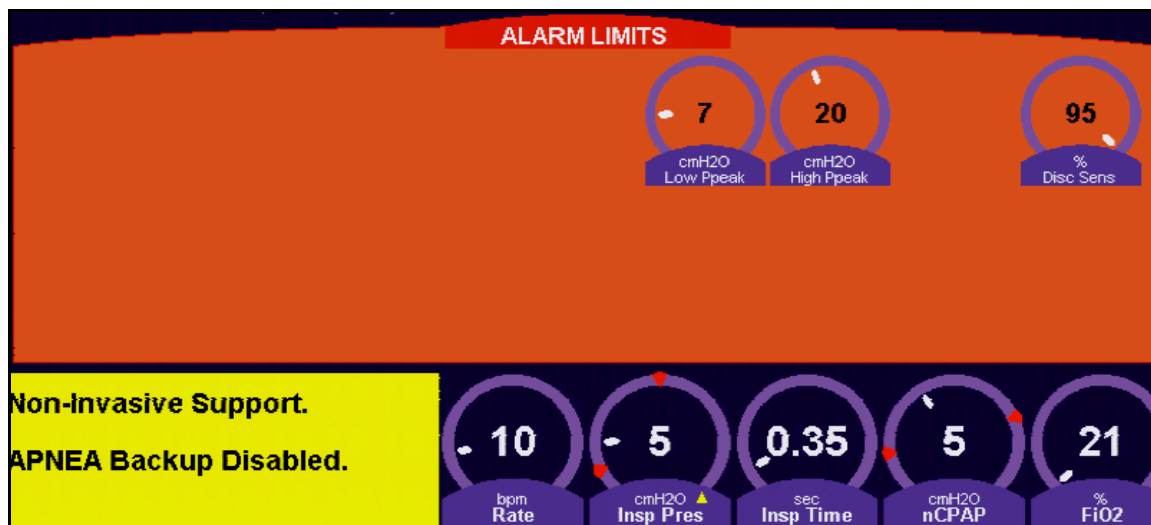

Low Ppeak

Range: 1 to 40 cmH₂O (Neonate setting – nCPAP / IMV)

Default: 7 cmH₂O

Note:

Not available in nasal CPAP mode unless Rate of one or greater is set.

Alarm threshold setting changes during nCPAP / IMV will not be retained for other ventilation modes following exiting from nasal CPAP mode.

High Ppeak

Range: 2 to 45 cmH₂O (Neonate setting – nCPAP / IMV)

Default: 20 cmH₂O

Note:

Not available in nasal CPAP mode unless a Rate of one or greater is set.

Alarm threshold setting changes during nCPAP / IMV will not be retained for other ventilation modes following exiting from nasal CPAP mode.

nCPAP/IMV Disconnect Sensitivity

In nCPAP/IMV, patient circuit disconnect is based on characterization of the nasal prongs, carried out during the nCPAP breathing circuit characterization.

In nCPAP/IMV, the CIRCUIT DISCONNECT alarm is based on leak flow during exhalation (periods of baseline pressure). The circuit characterization provides a value for leak flow with the prongs removed from the nose. An alarm will be indicated if, the leak flow exceeds an operator set percentage of this characterized leak flow. This alarm will activate within 15 seconds of disconnect.

Range: 20 – 95 %

Resolution: 5%

Default: 95 %



The Disconnect Sensitivity setting banner appears in the message bar. The current measured leak is displayed on the left side of the banner and the Disconnect Sensitivity setting is displayed on the right. The background colors illustrate leak in blue relative to the Disconnect Sensitivity setting.

Following completion of Nasal CPAP / IMV characterization procedure, note the measured leak percentage. While the nasal prongs are still disconnected, set the Disconnect Sensitivity slightly below the measured leak percentage. This will help with proper disconnect detection, especially when using small prongs.

Note:

The Disconnect Sensitivity alarm is only available when a Rate of one or greater is set.

If the measured leak is within 5% of the Disconnect Sensitivity setting, the measured leak value will be displayed in RED alerting the operator to an impending alarm.



When the Circuit Disconnect alarm is asserted, the Disconnect Sensitivity setting banner background will display the leak level above the Disconnect Sensitivity setting in RED until the alarm situation is resolved.

WARNING!

Under certain conditions, such as small prongs and high respiratory rates, the Circuit Disconnect Alarm may not recognize that the prongs have been dislodged from the nares. Ensure proper physiologic monitoring is used.

High nCPAP pressure

A high priority audible/visual alarm will be activated whenever the nCPAP exceeds the high airway pressure threshold for a period greater than 15 seconds.

Threshold: Set CPAP Level + 3 cmH₂O

Tolerance: ± 0.5 cmH₂O

Note:

Threshold is automatically updated upon acceptance of a change in the nCPAP control setting.

Low nCPAP Pressure

A high priority audible/visual alarm will be activated whenever the nCPAP pressure falls below the low airway pressure threshold for a period greater than 15 seconds.

Threshold: Set CPAP Level - 2 cmH₂O (if set CPAP ≥ 3 cmH₂O)

Set CPAP Level - 1 cmH₂O (if set CPAP < 3 cmH₂O)

Tolerance: ± 0.5 cmH₂O

Note:

Threshold is automatically updated upon acceptance of a change in the nCPAP control setting.

nCPAP Pressure Limit

A high priority audible/visual alarm will be activated whenever the nCPAP pressure is greater than airway pressure limit for 3 seconds. The alarm will deactivate when the nCPAP pressure drops below 4.5 cmH₂O.

Pressure Limit: 11 cmH₂O (nCPAP only, rate set to off)

Set CPAP Level + Inspiratory Pressure + 3 cmH₂O (nCPAP / IMV, rate not zero)

Tolerance: + 0.5 cmH₂O

Volume Guarantee Alarms

Wye Sensor Disconnect

An audible/visual alarm will be activated, and FLOW SENSOR ERROR will be displayed when all of the following are true: 1) neonatal flow sensor is in use; 2) volume guarantee function is enabled; and 3) monitored V_{ti} drops below 20% of the net delivered volume. In this case, the system will revert to the operator set Inspiratory Pressure.

Alarm delay: 3 breaths, or 10s if greater, or 30s if less

Alarm priority: Medium

WARNING!

Disconnecting the proximal flow sensor or removing it from the circuit while Volume Guarantee is active will cause the ventilator to deliver pressure ventilation at the set Inspiratory Pressure.

Low P_{peak}

Range: 1 to 80 cmH₂O

Default: 5 cmH₂O

High P_{peak}

Range: 10 to 85 cmH₂O

Default: 30 cmH₂O

Low Expired Volume

An audible/visual alarm will be activated, and LOW V_{te} will be indicated whenever volume guarantee is active, and monitored expiratory tidal volume is less than the set threshold from the volume target.

Volume threshold: 90% of Volume target

Alarm delay: 30s or 10 breaths (whichever is greater)

Alarm priority: Medium

Limit volume

All VG breaths will be cycled by volume if inspired volume exceeds a threshold based on the set Volume Target and the leak (expressed as fraction), averaged over the previous 30 seconds.

The Volume Limit calculation varies with the degree of leak:

Mean Leak < 63%: Volume limit = (Volume Target x 1.3) x ((1.1 x Leak)+1)

Mean Leak >= 63%: Volume limit = Volume Target x 2.2

Note:

Test breaths in TCPL may be subject to the non-adjustable volume limit.

Alarm activation

Throughout activation of the following alarms, delivered breaths are disabled and the VG control algorithm will be inactive; on deactivation the VG control algorithm will reset, with 'test breaths' delivered at the operator set Insp Pres.

Circuit Disconnect

Safety Valve Open

Vent INOP

The system will reset to operator-prescribed pressure during the period of activation of the following alarm conditions, and will restart the tidal volume targeting algorithm on deactivation:

Low Ppeak

Low PEEP

Flow sensor error

Note:

Low Tidal Volume, High Tidal Volume and Low Vte Alarm Sensitivity settings are not applicable when Volume Guarantee is active.

This page intentionally left blank

Chapter 8: Maintenance and Cleaning

Cleaning and Sterilization

The AVEA is designed for easy maintenance. All exposed parts of the ventilator are corrosion resistant.

CAUTION!

DO NOT submerge the ventilator or pour cleaning liquids over or into the ventilator.

DO NOT sterilize the ventilator. The internal components are not compatible with sterilization techniques.

DO NOT gas sterilize or steam autoclave adapters or connectors while attached to the tubing. The tubing will, over time, take the shape of the adapter, causing poor connection and possible leaks.

To minimize cleaning and replacement frequency, the AVEA design places the exhalation manifold, flow sensor and diaphragm behind the exhalation filter and water trap.

Limitations on Reprocessing

There are instructions supplied by other manufacturers for individual parts and accessories that are included with the ventilator. Follow those directions for processing between patients.

Instructions

Point of Use: Follow your institutions procedures for removing material from a patient area for processing.

Preparation for Decontamination: There are no special requirements regarding Preparation for Decontamination for these parts.

Automated Cleaning: Follow cleaning instructions below. No specific automatic cleaning devices have been validated.

Manual Cleaning:

Cleaning External Surfaces: All external surfaces of the ventilator (the Exhalation cartridge included), can be wiped clean with one of the following: Isopropyl Alcohol or Chlorine Compounds with a maximum concentration of 1:10.

Cleaning Accessories and Parts: ONLY the following three parts are cleanable using an enzyme pre-soaking solution: The Water Trap (PN 50000-40035), the Infant Hot Wire Flow sensor (PN 16465) and the Water Collection Jar (PN 33985)

1. Prepare an enzyme based pre-soaking solution such as Klenzyme® (made by Steris Corporation, Mentor, OH) or equivalent in accordance with manufacturer's instructions, using sterile distilled water at 20-30 degrees Celsius (68-86 degrees Fahrenheit)
2. Immerse the part to be cleaned in the prepared solution for 2-5 minutes, making sure that all lumens and air pockets are completely filled with the solution, and agitate periodically.
3. Remove the part from the solution after 2-5 minutes and rinse immediately by immersing in at least 1 gallon of sterile distilled water at 20-30 degrees Celsius (68-86 degrees Fahrenheit). Leave the part in the rinsing bath for at least 1 minute agitating periodically to ensure thorough rinsing.

4. Visually inspect the part after removing it from the rinse to ensure that no debris remains on the part.
5. Repeat the cleaning method if necessary.

Cleaning the outside of the Capnometry sensor and cable:

1. Use a cloth dampened with 70% isopropyl alcohol, 10% bleach solution, disinfectant spray cleaner such as Steris Coverage® SprayHB, ammonia, or mild soap.
2. Wipe surfaces with a clean, water-dampened cloth before use. Ensure that the sensor is clean and dry before use.

Maintenance, Inspection and Testing:

An Extended System Test (EST) should be performed every time when cleaned components are re-assembled for use, to check for leaks.

Packaging:

Follow your institution's guidelines for packaging of material for sterilization.

Sterilization:

Only the following parts can be steam sterilized (autoclave): The Water Trap (PN 50000-40035), the Infant Hot Wire Flow Sensor (PN 16465), and Water Collection Jar (PN 33985).

Steam **sterilization** (autoclave): maximum temperature 138 degrees Celsius (280 degrees Fahrenheit), minimum temperature 132 degrees Celsius (270 degrees Fahrenheit) for a maximum of 18 minutes and a minimum of 15 minutes (30 cycles maximum number for any of these parts).

Vacuum Steam Cycle: 3 pre-condition pulses (vacuum pulses). Sterilizer vacuum target set to 10-26 psig. Dwell at 132 - 138 degrees Celsius (270 to 280 degrees Fahrenheit) for 4 to 8 minutes duration. (50 cycles maximum for the hot-wire infant flow sensor and 25 cycles maximum for the water trap/water collection jar).

Drying following steam cycle:

Minimum dry time: 15 minutes

The Infant Hot Wire Flow Sensor (part no. 16465) may also be cold sterilized using a 2.4% glutaraldehyde solution.

Storage:

Temperature: -20 to 60 degrees Celsius (-4 to 140 degrees Fahrenheit)

Humidity: 0 to 95% Relative Humidity non-condensing.

Capnometry Airway Adapters

Reusable Adapters

Clean reusable adapters by rinsing them in warm soapy water followed by soaking them in a liquid disinfectant such as 70% isopropyl alcohol, 10% bleach solution, 2.4% glutaraldehyde solution such as Cidex®, Steris System1® or ammonia. Rinse with sterile water and dry before use.

The adapter may also be disinfected using one of the following methods:

- Steam autoclave the adapter (adult adapter only).
- Immerse and soak the adapter in 2.4% glutaraldehyde solution such as Cidex for 10 hours.
- Immerse and soak the adapter in 0.26% paracetic acid solution such as Perasafe® for 10 minutes.
- Use Cidex OPA (follow manufacturer's instructions for use).

Before reusing the adapter, ensure the windows are dry and free of residue, and that the adapter has not been damaged during the cleaning/disinfecting process.

Disposable Adapters

Treat all single-patient use adapters in accordance with institutional protocol for single patient use items.

Additional Information

The following are considered disposable parts and, therefore, **CareFusion does not** recommend a method of cleaning or sterilization:

- Disposable Variable Orifice Flow Sensors (PN 50000-40038 and PN 50000-40031)
- Tracheal Adapters (PN 50000-40034)
- Tracheal Catheters (PN 10635)
- Catheter Extension Tubes (PN 50000-09910 and PN 50000-09920)
- Esophageal Catheters (PN 7003401 and PN 7003100)
- Nasogastric Pressure Monitoring Tubes (PN 7003300 and PN 7003402)
- Esophageal Pressure Monitoring Tube Set (PN 7003503)
- AVEA Disposable Water Trap (PN 11556)
- AVEA Disposable Expiratory Filter/Water Trap assembly (PN 11590)
- Capnography single patient use airway adapters (PN 16605 and PN 16606)

The instructions provided above have been validated by the manufacturer of the medical device. It remains the responsibility of the processor to ensure that the reprocessing as actually performed using equipment, materials and personnel in the reprocessing facility achieve the desired result. This normally requires validation and routine monitoring of the process.

Recommended Periodic Maintenance

CareFusion is committed to product support. If you have any questions concerning your ventilator's operation or maintenance contact your product support representative as shown in Appendix A, Contact Information.

The batteries should undergo discharge/charge cycling quarterly (every three months).

A Preventive Maintenance service should be performed on your AVEA ventilator once per year. Call CareFusion, Customer Care, at the number given in Appendix A to arrange for a qualified Service Technician to perform this.

WARNING

Electric shock hazard - Do not remove any of the ventilator covers or panels. Refer all servicing to a service technician authorized by CareFusion.

The annual maintenance will include the following.

Replacement of:

- The Air inlet Filter
- The Oxygen Inlet Filter
- The Compressor Inlet Filter (on compressor equipped models)
- The Compressor Outlet Filter (on compressor equipped models)
- The Exhalation Diaphragm.

At this time the following maintenance will be performed:

- Removal & replacement of the above items
- Verification that the following transducers are within calibration specifications:
 - *Air*
 - *O₂*
 - *Blended Gas*
 - *Expiratory*
 - *Inspiratory*
 - *Exhaled Flow delta*
 - *Wye flow delta*
 - *Auxiliary*
 - *Esophageal*
- Replacement of the O₂ Sensor
- Verification Testing to confirm the ventilator is functioning within optimum parameters.
- Screen Calibration
- Calibration of the Capnostat
- Battery Performance Verification
- Every two years the following is recommended to be replaced:
 - *Internal Batteries*
 - *External Batteries*

AVEA Maintenance should only be performed by a trained and authorized service technician. CareFusion will make available to qualified technicians, service manuals, which include such items as circuit diagrams, component parts lists, calibration instructions and other information to assist in repair of those parts of the ventilator designated by the manufacturer as repairable items.

WARNING

If a mechanical or electrical problem is recognized while operating the ventilator, the ventilator must be removed from use and referred to qualified personnel for servicing.

Using an inoperative ventilator may result in patient injury.

Battery Care

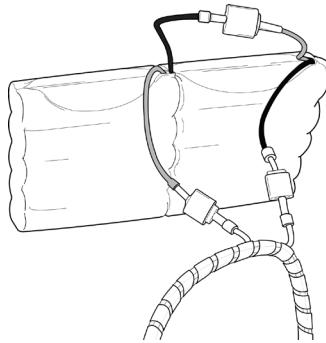

The AVEA has an internal, Nickel Metal Hydride battery pack that will provide power backup for short periods in the event that the mains power supply is lost (Figure 8–1). Under normal operating conditions and when fully charged, the internal battery is capable of powering the ventilator alone for 1 hour or the ventilator and compressor for 30 minutes.

Figure 8–1: Internal Battery Pack

Note:

The internal battery is intended only for short duration backup in the event of disruptions in line power. The internal battery provides 30 minutes of battery power for the ventilator and compressor nominally. The recharging cycle for this battery can be 4 hours or more depending on the state of discharge. Should you wish to perform intra-facility transport of patients you should equip your instruments with the optional external battery. The addition of the external battery will extend the time period to 2 hours for ventilator and compressor.

CareFusion recommends that when used in transport situations the expected transport time should not be greater than 50% of the usable battery life. This provides a safety margin in the event of schedule delays or premature consumption of the battery power. Should the expected transport time be delayed beyond this, a dedicated transport system should be considered. As with any patient transport, suitable manual ventilation backup should be available.

CAUTION

Prior to operating on battery power, the internal (and external if connected) battery indicator(s) should be green. The ventilator should be connected to a mains AC power supply until the battery indicator(s) show green prior to operating on battery power.

An optional sealed lead-acid (SLA) external battery pack is also available. This can significantly extend the operating period of the ventilator when it is not connected to an AC source. Under normal operating conditions, fully charged

external and internal batteries combined are capable of powering the ventilator *and* compressor for a period equal to or greater than 2 hours, and the ventilator on wall air for a period equal to or greater than 4 hours.

Both battery types are re-chargeable and require some maintenance when installed.

The internal battery should be discharged and recharged approximately once every three months.

The external battery should be discharged and recharged approximately once every twelve months.

The Battery Status Indicators on the front panel enable you to monitor the battery charge remaining (see "Chapter 7: Alarms and Indicators").

CAUTION

Should your internal battery require replacement, contact your CareFusion representative. Do NOT attempt to replace the battery yourself. The battery should only be replaced by a qualified technician.

Precedence of power use

The sequence in which the power sources are used by the ventilator is:

1. AC
2. External Battery (if installed)
3. Internal Battery

CAUTION

Do not store the ventilator in hot areas for prolonged periods of time. Temperatures above 80°F (27 °C) can shorten battery life. Failing to charge the ventilator while in storage may also shorten battery life.

CAUTION

When the integrity of the external power ground conductor arrangement is in doubt, operate the ventilator from its internal battery or the optional external battery.

Note: Refer to the Service Manual for battery maintenance and testing procedures.

Battery Status

Battery status indicators showing the state of charge of the internal and external batteries appear on the front panel of the ventilator (Figure 8–2).

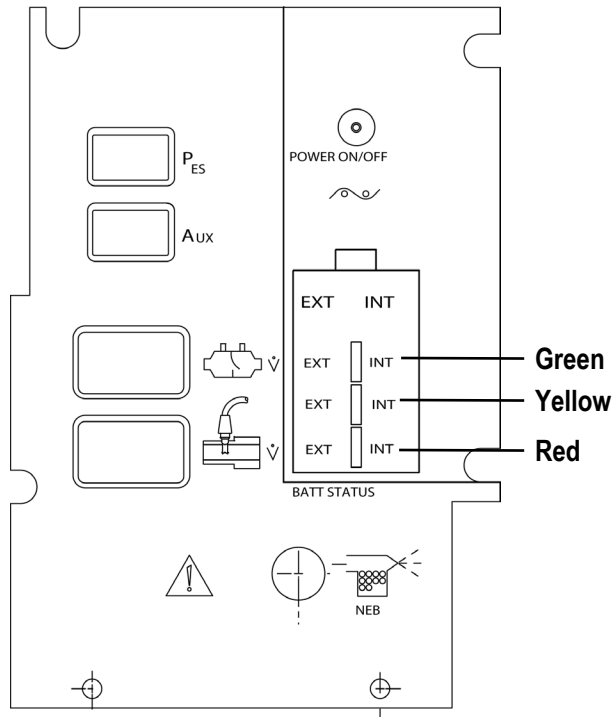

Figure 8–2: Front Panel Display Area. Comprehensive model shown.

If the battery charge is allowed to drop below the low range of the battery monitor, a battery status indicator LED may no longer be displayed. The unit should be plugged into the AC power supply to allow the batteries to re-charge. When the battery voltage becomes large enough to power the battery monitor, the battery status indicators will display.

Failure to charge

If the internal batteries do not show significant recharge after being reconnected to an AC power source for four hours contact your technical support representative as shown in Appendix A to arrange for replacement. Total time to recharge depends on the extent of battery depletion and ventilator usage while charging is taking place.

Note:

The batteries in a ventilator that is not in use and not connected to AC, will continue to slowly discharge. A fully charged battery may reach a deep discharge state due to self-discharge. However, even with a fully charged battery, if the ventilator is unplugged from AC for more than 4 hours, the internal battery status indicator will display red indicating a low battery condition. In this condition the ventilator should be plugged into an AC outlet for 10-12 minutes to restore the battery to the correct charge state.

Fuses

The AVEA has the following replaceable fuses associated with internal DC, external DC and AC power sources.

WARNING

Do not remove or replace fuses or perform any maintenance tasks on the ventilator while your patient is connected. Always perform these tasks "off patient".

Battery Fuses

The internal and optional external battery fuses are 10A, 250V (5 x 20 mm) fast blow type.

The fuse for the optional external battery is located on the back panel next to the external battery connector and is replaceable. The fuse for the internal battery is located to the right of the UIM connection. To remove fuses, carefully unscrew with a flat blade screwdriver and pull out the fuse holder.

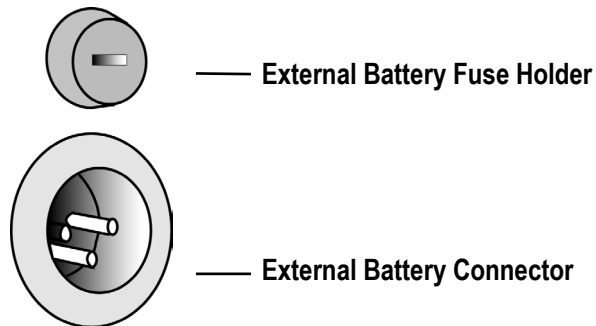

Figure 8-3: External Battery Connector & Fuse

WARNING

To avoid fire hazard, use only the fuse specified in the ventilator's parts list or one that is identical in type, voltage rating, and current rating to the existing fuse.

Mains Fuses

The main AC power fuses are housed within the power entry module located on the back panel. They are slow blow-type. Check that the correct voltage for your mains supply is showing through the window in the power entry module.

Table 8–1: Mains fuses

Line Voltage	Fuse	Amperage
100/120VAC	250V 6.35 x 31.75mm	3.2A
230/240VAC	250v 6.35 x 31.75mm	1.5A

Replacing a Mains Electrical Fuse

WARNING

Ensure that the mains power cord is unplugged before attempting to remove or replaces fuses.

To replace mains electrical fuses:

1. Unplug the ventilator from the mains AC power source and unplug the power cord from the power entry module on the rear of the ventilator.
2. Using a small flat blade screwdriver, pry open the cover of the power entry module.

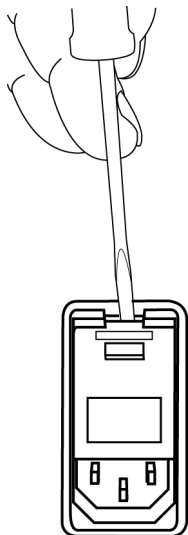

- Carefully ease the red fuse holder out of the power entry module.

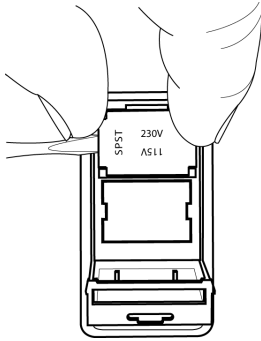

- The fuse holder contains two fuses, 3.1 amps (for 100/120 volt lines) and 2.0 amps (for 230/240 volt lines) as shown in Table 8-1.

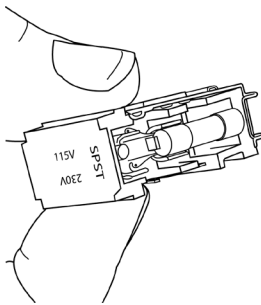

- Replace the failed fuse in the fuse holder with a fuse whose type, voltage rating, and current rating is identical to the fuses supplied from the factory.
- Carefully replace the red fuse holder into the power entry module. **Check to ensure that the correct line voltage is uppermost as you re-insert the fuse holder into the power entry module.**

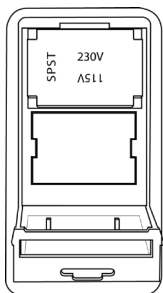

- Close the power entry module cover and check to make sure that the correct voltage is displayed through the window.

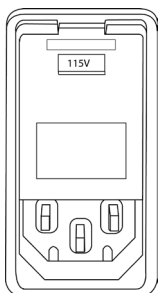

Appendix A: Contact and Ordering Information

How to Call for Service

To get help on performing any of the preventive maintenance routines, or to request service on your ventilator, contact CareFusion:

Technical and Clinical Support

Hours: 6:30 AM to 4:30 PM (PST) Monday through Friday

Phone: (800) 231-2466

Fax: (714) 283-8471

After hours service:

Phone:(800) 231-2466 from within the US and select option 2.

CareFusion Customer Care Helpline

Hours: 24 hours, seven days a week

Phone: (800) 231-2466 from within the United States

Online service for warranty replacements parts can be found at

carefusion.com

Select "Warranty Form" from the choices on the left of the screen.

Ordering Parts

To obtain AVEA Ventilator parts, contact CareFusion customer service at:

Hours: 7:00 Am to 4:30 PM (PST)

Monday through Friday

Phone: (800) 328-4139

(760) 778-7200

Fax: (760) 778-7274

Accessories

Neonatal Kit Part Number 50-40012-00

CareFusion Part Number	Description	Quantity
50000-40038	Neonatal disposable flow sensor	1

External Battery Option

To add the external battery option to your AVEA, you will need to order the following parts:

CareFusion Part Number	Description	Quantity
33977	External Battery Tray Assembly	1
16217	External Battery Wire Harness	1
68269	AVEA External Battery	2

Other Replacement Parts and Accessories

CareFusion Part Number	Description
71667	Internal/External Battery Fuse
71612	100/120 VAC Mains Power Supply Fuse
56000-20064	230/240 VAC Mains Power Supply Fuse
33978	Gas Tank Rack Assembly
51000-40640	Filter Cartridge
11590	Disposable Expiratory Filter/Water Trap (case of 12)
11556	Disposable Water Trap (case of 12)

Advanced Physiologic Monitoring Parts and Accessories (Pkgs of 10)

CareFusion Part Number	Description
10635	Tracheal catheter 5 FR. Disposable
50000-09910	Tracheal catheter extension tube
50000-40034	Tracheal catheter adapter
7003100	Adult esophageal catheter 8 FR
7003401	Pediatric esophageal catheter 6 FR
50000-09920	Esophageal catheter extension tube
16401	Bicore Accessory Kit
7003300	Nasogastric Pressure Monitoring Tube Set, 16FR Adult
7003402	Nasogastric Pressure Monitoring Tube Set, 7FR Ped
7003503	Esophageal Pressure Monitoring Tube Set, 5FR Ped Neo

Capnography Parts and Accessories

CareFusion Part Number	Description
16578	Reusable CO ₂ Sensor (box of 1)
16605	Single-Patient Use Adult Airway Adapters (box of 10)
16606	Single-Patient Use Neonatal Airway Adapters (box of 10)
16607	Reusable Adult Airway Adapter (box of 1)
16608	Reusable Neonatal Airway Adapter (box of 1)
79044	5% CO ₂ Calibration Check Gas (box of 4)

This page intentionally left blank

Appendix B: Specifications

Pneumatic Supply

Air or Heliox Supply

Pressure Range:	20 to 80 psig (1.4 to 5.5 bar)	(Supply Air)
	20 to 80 psig (1.4 to 5.5 bar)	(Supply Heliox – 80% / 20% Heliox only)
	3 to 10 psig (0.2 to 0.7 bar)	(Compressor Air)
Temperature:	5 to 40° C (41 to 104° F)	
Humidity:	Dew Point of gas should be 1.7° C (3° F) below the ambient temperature (minimum)	
Minimum Flow:	80 L/min at 20 psig (1.4 bar)	
Air Inlet Fitting:	CGA DISS-type body, No. 1160. NIST fitting per BS-5682:1984 (Air) also available.	
Heliox Inlet Fitting:	CGA DISS-type body, No. 1180. NIST fitting per BS-5682:1984 (Heliox) also available.	

Oxygen Supply

Pressure Range:	20 to 80 psig (1.4 to 5.5 bar)	(Supply Oxygen)
Temperature:	5 to 40° C (41 to 104° F)	
Humidity:	Dew Point of gas should be 1.7° C (3° F) below the ambient temperature (minimum)	
Minimum Flow:	80 L/min at 20 psig (1.4 bar)	
Inlet Fitting:	CGA DISS-type body, No. 1240. NIST fitting per BS-5682:1984 (O ₂) also available.	

Electrical Supply

AC Power Supply

The ventilator operates within specification when connected to the following AC power supplies:

Nominal	Voltage Range	Frequency Range
100 VAC	(85 to 110 VAC)	47 to 65 Hz
120 VAC	(102 to 132 VAC)	55 to 65 Hz
230 VAC	(196 TO 253 VAC)	47 to 65 Hz
240 VAC	(204 TO 264 VAC)	47 to 65 Hz

DC Power Supply

The ventilator can also operate from a 24 VDC power source (internal or external battery).

Internal Battery:

The Internal Battery requires a minimum charge time of 4 hours to achieve a full charge. Under normal operating conditions, the internal battery is capable of powering the ventilator alone for 1 hour and powering the ventilator and compressor for 30 minutes when fully charged. The ventilator should be connected to a main A/C supply and charged for **at least 4 hours** prior to switching to battery power.

External Battery: 22.0 to 26.4 VDC

Under normal operating conditions, fully charged external and internal batteries combined are capable of powering the ventilator *and* compressor for a period of time equal to or greater than 2 hours and the ventilator alone for a period of time equal to or greater than 7 hours. With a discharged battery the ventilator should be connected to a main AC supply and charged for at least 12 hours to insure a full charge.

Data Input / Output

Independent Lung Ventilation (ILV)

The ventilator provides an output (master) and an input (slave) for synchronization of ventilators. The output supplies a 5 VDC logic signal synchronized to the breath phase of the master via a 25-pin connector on the rear of the ventilator. The pin configuration for this connector is as follows:

PIN	FUNCTION
1	Analog Input Channel 0
14	Analog Input Channel 1
18	ILV In
6	ILV Out
20	Factory Use Only, DO NOT CONNECT
22	Analog Output, PRESSURE
23	Analog Output, FLOW
24	Analog Output, VOLUME
25	Analog Output, BREATH PHASE
5,9,10,11,12,13	Ground, Analog

Note:

At least one analog ground is required for safe and accurate signal output and input.. One analog ground is sufficient for any and all of the other signals.

Analog Inputs

The ventilator provides 2 programmable channels for analog signal inputs as shown above. Each channel is scalable for the input ranges specified.

Ranges:	0 to 1 VDC
	0 to 5 VDC
	0 to 10 VDC
Resolution:	0.25 mV (for 0 to 1 VDC)
	1.37 mV (for 0 to 5 VDC)
	2.5 mV (for 0 to 10 VDC)

Analog Outputs

The ventilator provides 4 signals to the analog output connector:

1. Airway Pressure, P_{AW} :

Range:	-60 to 140 cmH ₂ O
Scale:	1 cmH ₂ O/25 mV
Accuracy:	± 50 mV or $\pm 5\%$ of reading, whichever is greater
Zero Offset:	1.5 VDC at 0 cmH ₂ O

2. Flow

Inspiratory/Expiratory:

When selected, the ventilator provides a continuous analog voltage representative of inspiratory flow minus expiratory flow.

Range:	-300 to 200 L/min (Adult)
	-120 to 80 L/min (Pediatric)
	-60 to 40 L/min (Neonate)
Scale Factor:	1 L/min / 10 mV (Adult)
	1 L/min / 25 mV (Pediatric)
	1 L/min / 50 mV (Neonate)
Accuracy:	$\pm 10\%$ of reading or ± 30 mV, whichever is greater
Zero Offset:	3.0 VDC at 0 L/min

Machine:

When selected, the ventilator provides a continuous analog voltage representative of machine delivered flow.

Range:	0 to 200 L/min (Adult)
	0 to 100 L/min (Pediatric)
	0 to 50 L/min (Neonate)

Scale Factor: 1 L/min / 25 mV (Adult)
1 L/min / 50 mV (Pediatric)
1 L/min / 100 mV (Neonate)

Accuracy: $\pm 10\%$ of reading or ± 30 mV, whichever is greater

Zero Offset: None

3. Volume:

Range: -1.00 to 4.00 L (Adult)
-200 to 800 ml (Pediatric)
-100 to 400 ml (Neonate)

Scale Factor: 1 L / V (Adult)
1 ml / 5 mV (Pediatric)
1 ml / 10 mV (Neonate)

Accuracy: $\pm 10\%$ of reading or ± 30 mV, whichever is greater

Zero Offset: 1.000 VDC

4. Breath Phase

The ventilator provides a continuous analog voltage representative of breath phase (Inspiration = 5 VDC, Expiration = 0 VDC).

Digital Communication

RS 232 Output

Sets the RS 232 output format for digital communications via the port labeled MIB.

The RS-232 output configuration provides the following setting choices:

Generic

This interface is available in AVEA software versions 3.3 and greater. The AVEA GSP Interface Kit is part number 16375 and includes a CAT-5 cable and a 9-pin adaptor.

Select 8, N, 1 and Baud Rates of: 9600, 2400, 4800, 9600, 19200, 38400, 57600 or 115200

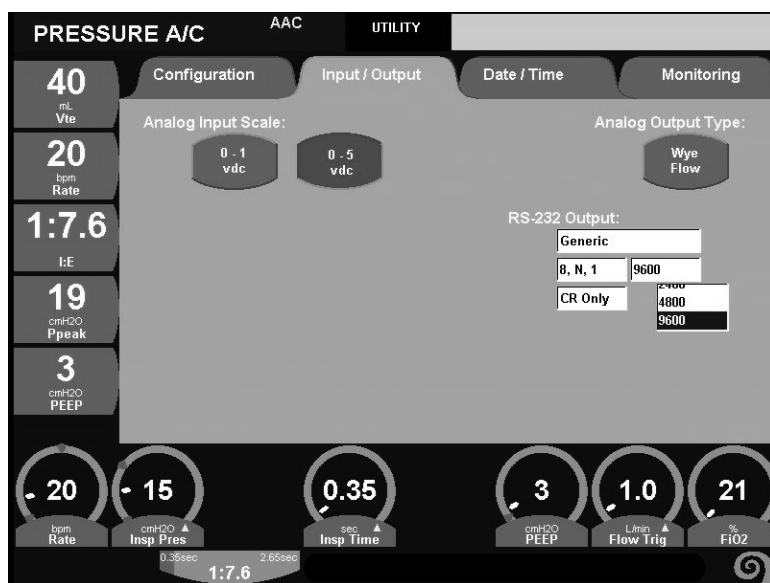
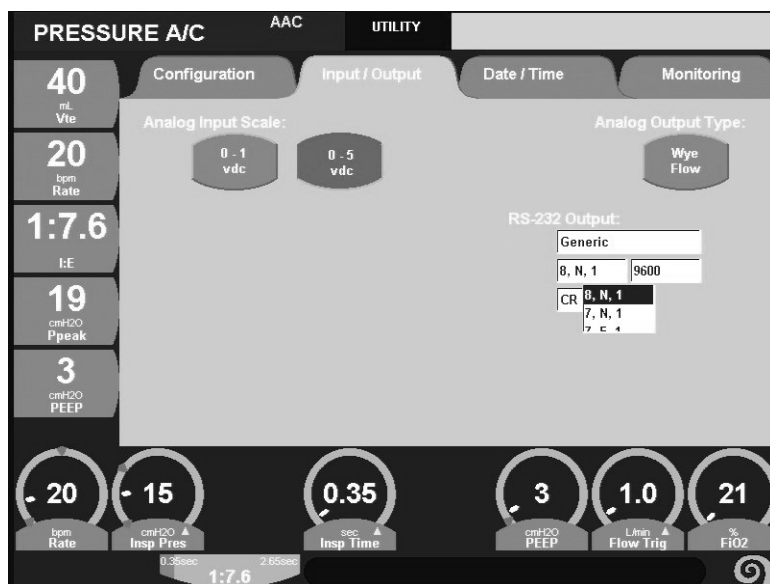

or
Select CR/LF or CR Only

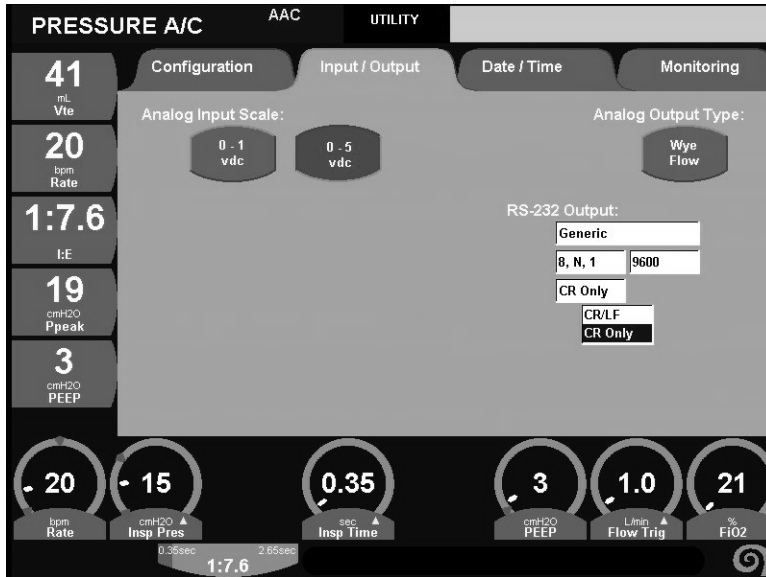

VueLink

AVEA software versions 3.1 and greater can be interfaced with the Phillips Vue-Link system. The part number of the Vue-Link CAT-5 serial cable and adaptor is 16337.



VOXP (Ventilator Open XML Protocol)

AVEA software versions 3.7 and greater support VOXP. The AVEA VOXP Interface kit is part number 16375 and includes a CAT-5 cable and a 9-pin adaptor.

Select either 8,N,1 / 7,N, 1 / 7, E, 1 or 7, 0, 1 and Baud Rates of: 9600, 19200, 38400, 57600, 115200

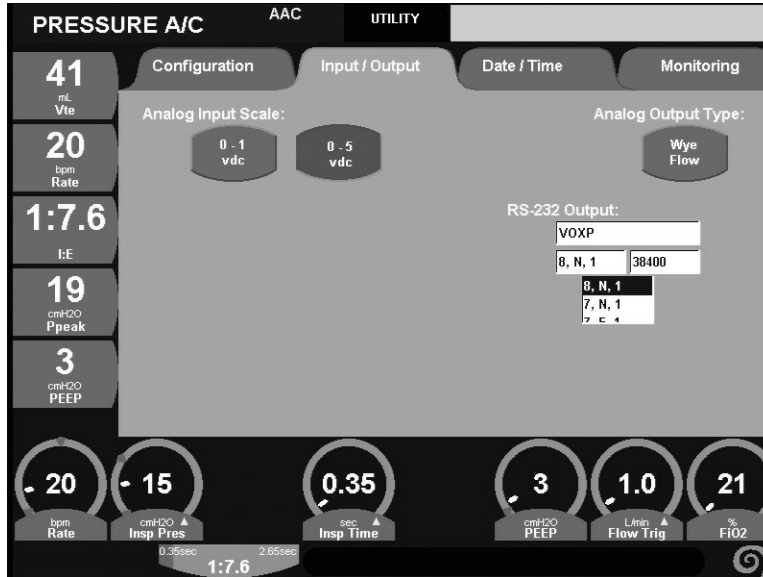

The ventilator has two RS-232 ports installed for bi-directional communication of data: RS-232 Ch1 is currently used for software updates as well as data communications to external systems.

VOXP Communications Requirements

Communication is established between a ventilator and an external system with a properly configured set of system-level items from physical cables, adapters, and communication parameters to application protocols. A detailed description of the interface is available in a separate specification, *Consolidated VOXP Specification*, part number L3058, Revision A, or later.

To ensure proper operation of the ventilator, there is an important limitation to the implementation of the interface with external devices. Waveforms should not be selected at baud rate settings less than 57600, and no more than 3 waveforms should be selected at baud rates of 57600 and higher. Waveform transmission requires high speed communications, and problems can occur if waveforms are requested at lower baud rates, or if too many waveforms are requested at high baud rates.

WARNING!

To ensure proper operation of the ventilator, external device communications using waveforms must follow the recommendations in *Consolidated VOXP Specification*, part number L3058, Revision A, or later. The MIB port must be connected to a device that meets the IEC60601-1 standard.

Printer

The ventilator has a standard 25-pin female Centronics parallel printer port for interfacing to an external printer.

Remote Nurse Call

The ventilator has a modular jack configured to interface with external systems that are either wired for normally open (N.O., close on alarm) or normally closed (N.C., open on alarm) signals.

In the active state, the remote alarm can sink 1.0 A.

Video Output

The ventilator provides a video output connector, which allows for interfacing to an externally located 256-color, 800 x 600, SVGA monitor. The Video Output is always enabled.

Language Support

The list of selectable languages on the AVEA are English, Chinese, Czech, Dutch, French, German, Greek, Hungarian, Italian, Japanese, Polish, Portuguese, Russian, Spanish, and Turkish.

Atmospheric & Environmental Specifications

Temperature and Humidity

Storage

Temperature:	-20 to 60° C (-4 to 140° F)
Humidity:	0 to 95% RH non-condensing

Operating

Temperature:	5 to 40° C (41 to 104° F)
--------------	---------------------------

Humidity: 0 to 95% RH non-condensing

Barometric Pressure

Barometric pressure is measured by an internal barometer automatically. This data is displayed as a monitor value on the setup screen.

Range: 760 to 545 mmHg

Physical Dimensions

Overall Size

Ventilator 17" W x 16" D x 10.5" H or (43.2 cm X 40.6 cm X 26.7 cm)

UIM 16.25" W x 2.5" D x 13.75" H (41.3 cm X 6.4 cm X 34.9 cm)

Weight

Ventilator w/ UIM no compressor \leq 73 lbs. (33.1 kg)

Ventilator w/UIM and Compressor \leq 80 lbs (36.3 kg)

Accessories

Pall Microbial Filter

Resistance

The exhalation filter supplied with your AVEA ventilator is manufactured by Pall Medical of Ann Arbor, MI, USA. The published maximum resistance of this filter is 4cmH₂O at 100 L/min for the 725 filter.

Compliance

The compliance for the filter is < 0.4 ml/cmH₂O.

Materials

Materials used in the construction of the filter have passed USP Class VI 121° C Plastic and Cytotoxicity test.

For further information please contact Pall Medical.

Water Trap

Resistance

The resistance of the internal exhalation water trap assembly including the collection bottle is < 0.5 cmH₂O at 50 L/min.

Compliance

The compliance of the internal exhalation water trap assembly including the collection bottle is < 0.2 ml/cmH₂O.

AVEA® Disposable Expiratory Filter / Water Trap

SPECIFICATIONS	
Viral & Bacterial Filtration Efficiency (VFE & BFE):	Greater than 99.999%
Particle Filtration Efficiency (PFE):	99.97% of 0.3 μ m nominal particle size at 60 L/min flow
Inlet Connector:	22 mm male with a 15 mm female conical connector
Outlet Connector:	22 mm male with a non-standard size female conical connector
Resistance to Flow:	Less than 1.0 cmH ₂ O at 60 L/min when new
Flow leakage:	Less than 0.01 L/min at 140 cmH ₂ O internal pressure
Size:	9.7 cm diameter, 33 cm tall (3.8 inches diameter, 13 inches tall)
Plastic material:	Polystyrene
Internal volume:	Approximately 500 mL
Compliance:	Less than 0.5 mL/cmH ₂ O
Condensate Water Trap capacity:	Approximately 130 mL (up to Maximum Fill Line)

Appendix C: Pneumatic Diagram

Gas Delivery Engine

The Gas Delivery Engine receives and conditions supplied Oxygen and Air from external and/or internal (compressor) sources. It then mixes the gas to the concentration required and delivers the desired flow, or pressure to the patient.

The Gas Delivery Engine begins with the Inlet Pneumatics. The Inlet Pneumatics accepts clean O₂, or Air; it provides extra filtration and regulates air and O₂ gas before entering the Oxygen Blender. The Oxygen Blender mixes the gases to the desired concentration before reaching the Flow Control Valve. The Flow Control Valve controls the flow rate of the gas mixture to the patient. Between the Oxygen Blender and Flow Control Valve, the Accumulator System is installed to provide peak flow capacity. The Flow Sensor provides information about the actual inspiratory flow for closed loop servo control. The gas is then delivered to the patient through the Safety/Relief Valve and Outlet Manifold.

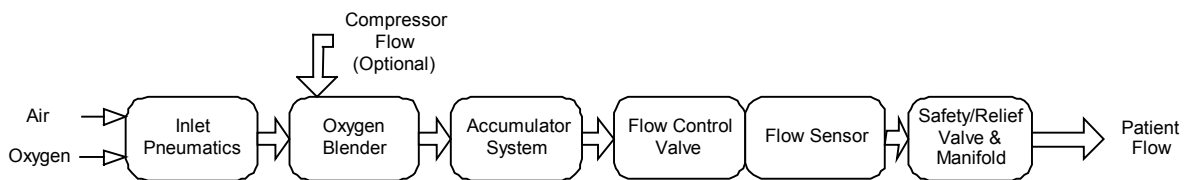

Figure C1 Gas Delivery Engine

This page intentionally left blank

Appendix D: Monitor Ranges and Accuracies

DISPLAY	DESCRIPTION	RANGE	ACCURACY
VOLUME MONITORS			
The volume measured during the inspiratory phase of the breath is accumulated as the inspired tidal volume, and the volume measured during the exhalation phase is accumulated as the exhaled tidal volume. This volume does not include the volume delivered by the Circuit Compliance Compensation function for volume breaths.			
Vte	Exhaled tidal volume. Exhaled volume readings are measured by the expiratory flow sensor. This reading may be affected by the humidifier setting in the ventilator. When using a proximal flow sensor, the VTe is measured as the expiratory flow goes away from the patient at the point of insertion of the sensor (between the patient interface and the wye)	0 to 4 L	(± 20ml + 10% of reading)-Adult machine sensor (± 1 ml + 10% of reading)-Neonate wye sensor
Vte/kg	Exhaled tidal volume adjusted for patient weight	0 to 4 ml/kg	
Vti	Inspired tidal volume. VTi is measured by the inspiratory flow sensor inside the ventilator and reflects the volume without compensating for tubing compliance. It is a calculation of the difference between the flow delivered and the flow exhaled during inspiration. When using a proximal flow sensor, the VTi is measured as the inspiratory flow (translated into volume) goes to the patient at the point of insertion of the sensor (between the patient interface and the wye).	0 to 4 L	(± 20ml + 10% of reading)-Adult machine sensor (± 1 ml + 10% of reading)-Neonate wye sensor
Vti/kg	Inspired tidal volume adjusted for patient weight	0 to 4 ml/kg	
Spon Vt	Spontaneous tidal volume. A zero (0) Spont Vt indicates the most recent breath was not a spontaneous breath. It is an instantaneous value.	0 to 4 L	(± 20ml + 10% of reading)-Adult machine sensor (± 1 ml + 10% of reading)-Neonate wye sensor
Spon Vt/kg	Spontaneous tidal volume adjusted for patient weight	0 to 4 ml/kg	
Mand Vt	Mandatory tidal volume. Displayed as a rolling average of either 8 breaths or one minute, whichever occurs first.	0 to 4 L	(± 20ml + 10% of reading)-Adult machine sensor (± 1 ml + 10% of reading)-Neonate wye sensor
Mand Vt/kg	Mandatory tidal volume adjusted for patient weight	0 to 4 ml/kg	Derived
Vdel	Total delivered machine volume measured by the ventilator's inspiratory flow sensor. This value will be greater than the VTi if tubing compliance compensation is active.	0 to 4L	(± 20ml + 10% of reading)-
% Leak	Percent leakage. The difference between the inspired and exhaled tidal volumes in terms of % difference.	Derived	Derived
Ve	Minute Volume. Volume of gas exhaled by the patient during the last minute.	0 to 99.9 L	Derived
Ve/kg	Minute volume adjusted for patient weight	0 to 999 ml/kg	Derived
Spon Ve	Spontaneous minute volume.	0 to 99.9L	Derived
Spon Ve/kg	Spontaneous minute volume adjusted for patient weight	0 to 999ml/kg	Derived
RATE/TIME MONITORS			
Rate	Breath Rate.	0 to 200 bpm	± 3% or ± 2 bpm whichever is greater
Spon Rate	Spontaneous breath rate. Reflects spontaneous rate for the last minute.	0 to 200 bpm	± 3% or ± 2 bpm whichever is greater

DISPLAY	DESCRIPTION	RANGE	ACCURACY
Ti	Inspiratory time.	0.00 to 99.99 sec	± 0.03 sec
Te	Exhalation Time.	0.00 to 99.99 sec	± 0.03 sec
I:E	Inspiratory/expiratory ratio <i>Note: Not active for demand breaths.</i>	1:99.9 to 99.9:1	Derived from accuracies for monitored Ti and Te

Display	Description	Range	Accuracy
f/Vt	Rapid shallow breathing index.	0 to 500 b ² /min/L	Derived from accuracies for spontaneous breath rate and spontaneous minute volume
PRESSURE MONITORS			
Ppeak	Peak inspiratory pressure. Not active with spontaneous breaths	0 to 120 cmH ₂ O	± 3.5% of reading or ± 2 cmH ₂ O, whichever is greater
Pmean	Mean airway pressure.	0 to 120 cmH ₂ O	± 3.5% of reading or ± 2 cmH ₂ O, whichever is greater
Pplat	Plateau pressure. If no plateau occurs, then the monitor displays ***	0 to 120 cmH ₂ O	± 3.5% of reading or ± 2 cmH ₂ O, whichever is greater
PEEP	Positive end expiratory pressure.	0 to 60 cmH ₂ O	± 3.5% of reading or ± 2 cmH ₂ O, whichever is greater
Air Inlet	Air inlet gas supply pressure.	0 to 80 psig	± 5 psig (1.4 – 5.5 bar)
O ₂ Inlet	Oxygen inlet gas supply pressure.	0 to 80 psig	± 5 psig (1.4 - 5.5 bar)
Pbaro	Barometric pressure	760 to 545 mmHg or 101 to 72.7 kPA	± 2% of full scale
GAS COMPOSITION MONITORS			
FiO ₂	Delivered percent O ₂ .	0 to 100%	± 3%
MECHANICS			
Cdyn	Dynamic Compliance (C _{DYN} and C _{DYN} / Kg), absolute and normalized to patient weight.	0 to 300 ml/cmH ₂ O	Derived
Cdyn/Kg		0.00 to 5.00 ml/cmH ₂ O·kg	
Cstat	Respiratory System Compliance (C _{RS}), (a.k.a. Static Compliance C _{STAT}), absolute and normalized to patient weight. <i>Note: This requires an Inspiratory Hold maneuver.</i>	0 to 300 ml/cmH ₂ O	Derived
Cstat/Kg		0.00 to 5.00 ml/cmH ₂ O·kg	
Rrs	Respiratory system resistance. <i>Note: Calculation is performed during an Inspiratory Hold maneuver.</i>	0 to 100 cmH ₂ O/L/sec	Derived
PIFR	Peak Inspiratory flow rate.	0 to 300 L/min (All patients)	± 10% of setting or ± (0.2 L/min + 10% of setting), whichever is greater
PEFR	Peak Expiratory flow rate.	0 to 300 L/min (All patients)	± 10% of setting or ± (0.2 L/min + 10% of setting), whichever is greater
Ccw	The ratio of the tidal volume (exhaled) to the Delta Esophageal Pressure (dP _{ES}). Requires an esophageal balloon.	0 to 300 mL/cmH ₂ O	± 10%

Display	Description	Range	Accuracy
C_{LUNG}	The ratio of the tidal volume (exhaled) to the delta transpulmonary pressure. The delta transpulmonary pressure is the difference between the airway plateau pressure (during an inspiratory pause) and esophageal pressure (at the time the airway plateau pressure is measured) minus the difference between the airway and esophageal baseline pressures. Requires an inspiratory hold and esophageal balloon.	0 to 300 mL/cmH ₂ O	± 10%
C₂₀ / C	The ratio of the dynamic compliance during the last 20% of inspiration (C ₂₀) to the total dynamic compliance (C).	0.00 to 5.00	± 10%

Display	Description	Range	Accuracy
R_{RS}	The total resistance during the inspiratory phase of a breath. Respiratory System Resistance is the ratio of the airway pressure differential (peak – plateau) to the inspiratory flow 12 ms prior to the end of inspiration. Requires an inspiratory hold.	0 to 100 cmH ₂ O/L/sec	± 10%
R_{PEAK}	The Peak Expiratory Resistance (R _{PEAK}), is defined as the resistance at the time of the Peak Expiratory Flow (PEFR).	0.0 to 100.0 cmH ₂ O/L/sec	± 10%
R_{IMP}	The airway resistance between the wye of the patient circuit and the tracheal sensor. Requires an inspiratory hold and tracheal catheter.	0.0 to 100.0 cmH ₂ O/L/sec	± 10%
R_{LUNG}	The ratio of the tracheal pressure differential (peak – plateau) to the inspiratory flow 12 ms prior to the end of inspiration. Requires an inspiratory hold and tracheal catheter.	0.0 to 100.0 cmH ₂ O/L/sec	± 10%
dP_{AW}	The difference between peak airway pressure (P _{PEAK AW}) and baseline airway pressure (PEEP _{AW}).	–120 to 120 cmH ₂ O	± 2 cm H ₂ O or ± 5% whichever is greater
dP_{ES}	The difference between peak esophageal pressure (P _{PEAK ES}) and baseline esophageal pressure (PEEP _{ES}).	–120 to 120 cmH ₂ O	± 2 cm H ₂ O or ± 5% whichever is greater
AutoPEEP	The airway pressure at the end of an expiratory hold maneuver. Requires a passive patient.	0 to 50 cmH ₂ O	± 2 cm H ₂ O or ± 5% whichever is greater
dAutoPEEP	The difference between airway pressure at the end of an expiratory hold maneuver and the airway pressure at the start of the next scheduled breath after the expiratory hold maneuver. Requires a passive patient.	0 to 50 cmH ₂ O	± 2 cm H ₂ O or ± 5% whichever is greater
AutoPEEP_{ES}	The difference between esophageal pressure measured at the end of exhalation (PEEP _{ES}) minus the esophageal pressure measured at the start of a patient-initiated breath (P _{ES start}) and the sensitivity of the ventilator’s demand system. The sensitivity of the ventilator’s demand system is the difference between the baseline airway pressure (PEEP _{AW}) and the airway pressure when the patient initiates a breath (P _{AW start}). Requires an esophageal balloon.	0 to 50 cmH ₂ O	± 2 cm H ₂ O or ± 5% whichever is greater
Ptp Plat	Transpulmonary pressure during an inspiratory hold, which is the difference between the airway plateau pressure (P _{PLAT AW}) and the corresponding esophageal pressure. Requires an inspiratory hold and esophageal balloon.	–60 to 120 cmH ₂ O	± 2 cm H ₂ O or ± 5% whichever is greater

Display	Description	Range	Accuracy
P _{tp} PEEP	The difference between the corresponding airway and esophageal pressures at the end of the expiratory hold during an AutoPEEP maneuver. Requires an inspiratory hold and esophageal catheter.	-60 to 120 cmH ₂ O	± 2 cmH ₂ O or ± 5%, whichever is greater
MIP	The maximum negative airway pressure that is achieved by the patient, during an expiratory hold maneuver.	-60 to 120 cmH ₂ O	± 2 cmH ₂ O or ± 5%, whichever is greater
P ₁₀₀	The negative pressure that occurs 100 ms after an inspiratory effort has been detected.	-60 to 120 cmH ₂ O	± 2 cmH ₂ O or ± 5%, whichever is greater

Display	Description	Range	Accuracy
WOB _v	The summation of airway pressure (P _{AW}) minus the baseline airway pressure (PEEP _{AW}) times the change in tidal volume to the patient (ΔV) during inspiration, and normalized to the total inspiratory tidal volume (V _i).	0.00 to 20.00 Joules/L	± 10%
WOB _p	Patient Work of Breathing (WOB _p), normalized to the total inspiratory tidal volume. Patient work of breathing is defined as the summation of two work components: work of the lung and work of the chest wall. Requires an esophageal balloon.	0.00 to 20.00 Joules/L	± 10%
WOB _i	The work performed by the patient to breathe spontaneously through the breathing apparatus, i.e. the E.T. tube, the breathing circuit, and the demand flow system. Requires a tracheal catheter.	0.00 to 20.00 Joules/L	± 10%

Note:

Monitored values are displayed as BTPS

Appendix E: Sensor Specifications & Circuit Resistance

VarFlex® Sensor Specifications

Table E.1 Varflex Flow Sensor Specifications

Sensor	Infant 15 mm	Adult 15 mm
Part Number	7002500	7002300
Type	Single Use	Single Use
Circuit Location	Wye	Wye
Performance Specifications		
Flow Range	0.024 to 30 L/min	1.2 to 180 L/min
Diff Pres Range	± 5.72 cmH ₂ O	± 5.72 cmH ₂ O
Accuracy*	± (0.012 L/min + 5% or reading)	± (0.1 L/min + 5% or reading)
Resistance	4.5 cmH ₂ O @ 30 L/min	2.4 cmH ₂ O @ 60 L/min
Dead Space	0.7 ml installed	9.6 ml installed
Freq. Response**	17 Hz	26 Hz
Airway Pres Range	-140 to 140 cmH ₂ O	-140 to 140 cmH ₂ O
Calibration (EEPROM)	29 Point Curve	29 Point Curve
Linearity	< 1% between points	< 1% between points
Operating Temperature	5° to 40° C 41° to 104° F	5° to 40° C 41° to 104° F
Physical Specifications		
Sensor Length	1.36 in (3.5 cm)	2.45 in (6.2 cm)
Diameter Insp (Vent Side)	15 mm OD	15 mm OD
Diameter Exp (Patient)	15 mm OD	15 mm OD
Tube Length	48 in (121.9 cm)	73 in (185.4 cm)
Connector	Bicore Proprietary	Bicore Proprietary
Weight	22 g (0.7 oz)	31 g (1.0 oz)
Service Life	Single Patient Use	Single Patient Use
Sterilization	NA	NA
Material	Sensor – Lexan Flap – Mylar Tubing – PVC Connector - ABS	Sensor – Lexan Flap – Mylar Tubing – PVC Connector - ABS

L/min: Dry air at 77° F (25° C) and 14.7 psig barometric pressure.

* Includes ± 1% for linearity and hysteresis with no zero drift for the pressure transducer and ± 2 % for temperature and humidity variations.

The sensor must be corrected for barometric pressure, and oxygen concentration.

** Frequency Response is signal attenuation to 0.707 input and assumes 100 Hz sample rate.

Hot Wire Flow Sensor Specifications

Table E-2 Hot wire sensor specifications

Part Number	51000-40081
Type:	Multiple use heated wire
Circuit Location:	Wye
Performance Specifications	
Flow Range:	0 (+/- 0.002) to 30 L/min
Vol. Accuracy:	+/-10%
Flow Resistance:	6 cmH ₂ O @ 20 L/min
Dead Space:	0.8 mL
Freq. Response*:	16 Hz
Calibration:	36 point curve
Linearity:	< 2%
Operating Temperature:	5 to 40°C
Physical Specifications	
Sensor length	1.68"
Diameter Insp (Vent Side)	15 mm OD
Diameter Exp (Patient Side)	15 mm OD
Tube length	N/A
Connector	Pin & Socket type
Weight	< 10g (not including wire)
Service Life	25 cycles
Sterilization	Steam Autoclave
Materials	Sensor - Delrin Wire - Platinum Screen - Stainless Steel 304 or 316 Pin - PhBz, gold over nickel plated Spacer - Delrin

Circuit Resistance Test

The resistance of a neonatal patient circuit should be tested for proper functionality of the ventilator for neonatal patient size applications. Excessive circuit resistance under these circumstances may result in triggering a Circuit Occlusion Alarm.

This resistance test applies to all neonatal applications except nCPAP.

1. To measure the resistance of the breathing circuit, set-up the system as follows:

Mode	TCPL AC
Flow Correction	ATPD (Set in utility screen, configuration tab)
Rate	4
Inspiratory Pressure	10 cmH ₂ O
Peak Flow	15 L/min
Inspiratory Time	3.0 sec
PEEP	0 cmH ₂ O
Flow Trigger	20 L/min
Pressure trigger	20 cmH ₂ O
% O ₂	21 % (no Heliox)
Bias Flow	2 L/min
Humidifier	Dry chamber inline, humidifier power off
Patient circuit	Clean and dry
Expiratory Filter	Installed, clean and dry
Test Lung	Not used, block the wye

2. Select waveforms P_{insp} and P_{aw}.
3. With the patient wye blocked, allow a TCPL breath to occur, and then press the FREEZE key and scroll the Cursor Line with the data dial until it is positioned in the middle of the inspiration portion of the breath.
4. Read the pressure from the P_{insp} and P_{aw} waveforms from the Cursor Line data.
5. Subtract P_{aw} from P_{insp}. $P_{insp} - P_{aw} = X \text{ cmH}_2\text{O}$
6. The resulting pressure difference (X cmH₂O) must not exceed 3.1cmH₂O at a flow of 15 L/min, and there must not have been an occlusion alarm active for that breath.
7. Reset the “Flow Correction” setting in the Utility screen to “BTPS” (normal setting for patient use).

Note:

We do not recommend using a neonatal circuit in a pediatric patient size application.

Volumetric Capnography Specifications

Sensors	
Sensor Type	Mainstream, non-dispersive infrared single-beam optics, dual wavelengths. No moving parts
Sensor Physical Characteristics	Weight: 25 g (78 g with standard cable and connectors) Size: 33 mm x 43 mm x 23 mm. Cable length: 3 m
Sensor Compatibility	The CareFusion Capnostat 5 is interchangeable between CareFusion equipment only.
CO₂ Measurement	
CO ₂ Measurement range	0 – 150 mmHg (0 – 20 kPa)
CO ₂ Measurement Accuracy	± 2 mmHg for 0-40 mmHg
	± 5% of reading for 41-70 mmHg
	± 8% of reading for 71-100 mmHg
	± 10% of reading for 101-150 mmHg
CO ₂ Resolution	1 mmHg
CO ₂ Stability	< 0.8 mmHg over four hours
Gas Composition Compensation	Oxygen and Helium gas composition. Automatic compensation

Airway Adapters	
Adult/Pediatric Single Patient Use	For use with endotracheal tube greater than 4mm ID Dead space: 5 mL Weight: 7.7 g Color: Clear
Infant /Pediatric Single Patient Use	For use with endotracheal tube less than or equal to 4mm ID Dead space: < 1 mL Weight: 9.1 g Color: Purple
Adult/Pediatric Reusable	For use with endotracheal tube greater than 4mm ID Dead space: 5 mL Weight: 12 g Color: Black
Infant /Pediatric Reusable	For use with endotracheal tube less than or equal to 4mm ID Dead space: < 1 mL Weight: 14.9 g Color: Red
All components are Latex free	

Appendix F: AVEA Message Bar Text

AVEA MESSAGE BAR TEXT	CAUSE
"Confirm Apnea Settings."	Selection of CPAP/PSV or APRV on Mode Select popup when active.
"Proximal Flow Sensor required."	Acceptance of Volume Limit setting when Size is NEO, Volume Limit is active, and no Wye Flow Sensor connected (Varflex or Hotwire).
"Bias Flow insufficient to allow Flow Trigger."	Acceptance of Bias Flow setting or Flow Trigger setting when Flow Trigger < (Bias Flow + 0.5 lpm).
"Heliox concentration will change."	Acceptance of % O ₂ setting when Heliox is being used.
"Nebulizer not available."	Acceptance of Peak Flow setting < 15 lpm when Nebulizer is active or on pressing of Nebulizer membrane key when Peak Flow setting < 15 lpm
"Confirm inspiratory pressure settings."	Selection of Volume Limit control when Volume Limit active (i. e., not at default / highest value for patient size).
"Settings restored to defaults."	Patient Accept when New Patient selected.
"Compliance Compensation not active for NEO."	Size Accept when Size is NEO, and Circ Comp setting is non-zero.
"Minimum 0.2 sec Inspiratory Time."	Acceptance of any combination of settings that will produce an I-Time of less than 0.2 seconds.
"Maximum 4:1 I:E Ratio."	Acceptance of any combination of settings that will produce an I:E Ratio of 4:1 or greater.
"Maximum 3 sec Inspiratory Time."	Acceptance of any combination of settings when size is NEO that will produce an I-Time of greater than 3 seconds.
"Maximum 5 sec Inspiratory Time."	Acceptance of any combination of settings when size is PED or ADULT that will produce an I-Time of greater than 5 seconds.
"Invalid Calibration"	<u>Service State Only:</u> Validation failure, while calibration dialog box is active for selected device.
"Error saving Serial/Model Number"	<u>Service State Only:</u> On accept of Serial Number or Model Number Change.
Clear Messages	<u>Service State Only:</u> Validation success, while calibration dialog box is active for selected device.
"FCV Characterization in progress."	<u>Service State Only:</u> On start of Flow Control Valve characterization procedure.
"FCV Characterization complete."	<u>Service State Only:</u> On successful completion of Flow Control Valve characterization procedure.
"FCV Characterization failed."	<u>Service State Only:</u> Unsuccessful completion of Flow Control Valve characterization procedure. Validation failure characterization and tuning data.
Installed Software Version	Power Up
Current Time, Date, and Runtime Hours	Main key pressed.
"DPRAM Comm. Error, Ctrl"	Loss of Communication with Control microprocessor
"Printing."	Print Screen button was pressed; commenced sending screen data to printer.
"Printer Out of Paper."	Print Screen button was pressed, printer reported it is out of paper.
"Printer Offline."	Print Screen button was pressed; printer is not available.
"Printer Error."	Print Screen button was pressed; printer reported an error condition.

AVEA MESSAGE BAR TEXT	CAUSE
"Printer Ready."	Sending screen data to printer has completed.
"Printer Busy."	Print Screen button was pressed, device has not completed sending data from previous activation.
"Volume Limit disabled."	On disconnect of WFS (Neo or Hotwire) when Size is NEO and Volume Limit is active.
"Proximal Flow Sensor disconnected."	On disconnect of WFS, any type.
"Flow sensor is not Heliox-compatible."	On connect of Hotwire WFS when Heliox is active.
"Proximal Airway Line disconnected."	On disconnect of Proximal Pressure connection.
"Proximal Flow Sensor conflict."	On simultaneous connect of Hotwire and VarFlex WFS.
"Esophageal monitoring not available."	On connect of Esophageal Balloon when size is NEO.
"Tracheal monitoring not available."	On connect of Tracheal Catheter when size is NEO.
"Flow Sensor Error."	On power up, failure to validate any internal flow sensor.
"Wye Sensor Error."	On connect and failure to validate any proximal flow sensor.
"Device Error."	On detection of a fault classified as "Device Error"
"Esophageal Balloon Leak Test Failed."	On failure of Esophageal Balloon leak test.
"Stopped: Patient Effort Detected"	Upon detecting Patient effort in maneuvers which require a passive patient
"Proximal Flow Sensor Ready"	

Appendix G: Advanced Pulmonary Mechanics Monitored Parameters

Rapid Shallow Breathing Index (f / V_t)

The ventilator is capable of displaying the calculated value for Rapid Shallow Breathing Index (f / V_t), which is the spontaneous breath rate per tidal volume, and is based on the following formula:

$$f / V_t = f^2 / V_e, \text{ where } f = \text{spontaneous breath rate (BPM) and} \\ V_e = \text{spontaneous minute ventilation in LPM}$$

Range: 0 to 500 b²/min/L

Resolution: 1 b²/min/L

Chest wall Compliance (C_{CW})

Chest wall Compliance (C_{CW}), is the ratio of the tidal volume (exhaled) to the Delta Esophageal Pressure (dP_{ES}).

$$C_{CW} = \frac{V_{te}}{dP_{ES}}$$

Range: 0 to 300 mL/cmH₂O

Resolution: 1 mL/cmH₂O

Note: Requires an esophageal balloon catheter.

Accuracy: ± 10%

Lung Compliance (C_{LUNG})

Lung Compliance (C_{LUNG}), is the ratio of the tidal volume (exhaled) to the delta transpulmonary pressure. The delta transpulmonary pressure is the difference between the airway plateau pressure (during an inspiratory pause) and esophageal pressure (at the time the airway plateau pressure is measured) minus the difference between the airway and esophageal baseline pressures.

$$C_{LUNG} = \frac{V_{te}}{dP_{PLAT TP}}, \text{ where } dP_{PLAT TP} = (P_{PLAT AW} - P_{ES}) - (PEEP_{AW} - PEEP_{ES})$$

Range: 0 to 300 mL/cmH₂O

Resolution: 1 mL/cmH₂O

Note: Requires an Inspiratory Hold maneuver and an esophageal balloon catheter.

Accuracy: ±10%

Compliance Ratio (C_{20} / C)

Compliance Ratio (C_{20} / C), is the ratio of the dynamic compliance during the last 20% of inspiration (C_{20}) to the total dynamic compliance (C).

Range: 0.00 to 5.00

Resolution: 0.01

Accuracy: $\pm 10\%$

Respiratory System Resistance (R_{RS})

Respiratory System Resistance (R_{RS}), is the total resistance during the inspiratory phase of a breath. Respiratory System Resistance is the ratio of the airway pressure differential (peak – plateau) to the inspiratory flow 12 ms prior to the end of inspiration.

Range: 0 to 100 cmH₂O/L/sec

Resolution: 0.1 cmH₂O/L/sec

Limitation: Active for volume breaths only.

Note: Requires an Inspiratory Hold maneuver.

Accuracy: $\pm 10\%$

Peak Expiratory Resistance (R_{PEAK})

The ventilator shall be capable of calculating and displaying the Peak Expiratory Resistance (R_{PEAK}), which is defined as the resistance at the time of the Peak Expiratory Flow (PEFR).

$$R_{PEAK} = \frac{P_{PEFR}}{PEFR}$$

Range: 0.0 to 100.0 cmH₂O/L/sec

Resolution: 0.1 cmH₂O/L/sec

Accuracy: $\pm 10\%$

Imposed Resistance (R_{IMP})

Imposed Resistance (R_{IMP}), is the airway resistance between the wye of the patient circuit and the tracheal sensor.

Range: 0.0 to 100.0 cmH₂O/L/sec

Resolution: 0.1 cmH₂O/L/sec

Note: Requires an Inspiratory Hold maneuver and a tracheal catheter.

Accuracy: $\pm 10\%$

Lung Resistance (R_{LUNG})

Lung Resistance (R_{LUNG}), is the ratio of the tracheal pressure differential (peak – plateau) to the inspiratory flow 12 ms prior to the end of inspiration.

Range: 0.0 to 100.0 cmH₂O/L/sec

Resolution: 0.1 cmH₂O/L/sec

Note: Requires an Inspiratory Hold maneuver and a tracheal catheter.

Accuracy: $\pm 10\%$

Peak Inspiratory Flow Rate (PIFR)

The ventilator is capable of monitoring and displaying the actual peak inspiratory flow rate for the inspiratory phase of a breath.

Range: 0 to 300 LPM (All patients)

Resolution: 1 LPM (Adult/Pediatric)
0.1 LPM (Neonate)

Accuracy: $\pm 10\%$

Peak Expiratory Flow Rate (PEFR)

The ventilator is capable of monitoring and displaying the actual peak expiratory flow rate for the expiratory phase of a breath.

Range: 0 to 300 LPM (All patients)

Resolution: 1 LPM (Adult/Pediatric)
0.1 LPM (Neonate)

Accuracy: $\pm 10\%$

Delta Airway Pressure (dP_{AW})

Delta Airway Pressure (dP_{AW}), which is the difference between peak airway pressure (P_{PEAK AW}) and baseline airway pressure (PEEP_{AW}).

$$dP_{AW} = P_{PEAK AW} - PEEP_{AW}$$

Range: -120 to 120 cmH₂O

Resolution: 1 cmH₂O

Accuracy: ± 2cmH₂O or ± 5%, whichever is greater

Delta Esophageal Pressure (dP_{ES})

Delta Esophageal Pressure (dP_{ES}), is the difference between peak esophageal pressure (P_{PEAK ES}) and baseline esophageal pressure (PEEP_{ES}).

$$dP_{ES} = P_{PEAK ES} - PEEP_{ES}$$

Range: -120 to 120 cmH₂O

Resolution: 1 cmH₂O

Accuracy: ± 2cmH₂O or ± 5%, whichever is greater

AutoPEEP_{AW}

AutoPEEP_{aw}, is the airway pressure at the end of an expiratory hold maneuver.

Range: 0 to 50 cmH₂O

Resolution: 1 cmH₂O

Accuracy: ± 2cmH₂O or ± 5%, whichever is greater

Note:

Requires a passive patient.

Delta AutoPEEP_{AW} (dAutoPEEP_{AW})

Delta AutoPEEP_{AW} (dAutoPEEP_{AW}), is the difference between airway pressure at the end of an expiratory hold maneuver and the airway pressure at the start of the next scheduled breath after the expiratory hold maneuver.

Range: 0 to 50 cmH₂O

Resolution: 1 cmH₂O

Note: Requires a passive patient.

Accuracy: $\pm 2\text{cmH}_2\text{O}$ or $\pm 5\%$, whichever is greater

AutoPEEP_{ES}

AutoPEEP_{ES} is defined as the difference between esophageal pressure measured at the end of exhalation (PEEP_{ES}) minus the esophageal pressure measured at the start of a patient-initiated breath (P_{ES start}) and the sensitivity of the ventilator's demand system. The sensitivity of the ventilator's demand system is the difference between the baseline airway pressure (PEEP_{AW}) and the airway pressure when the patient initiates a breath (P_{AW start}).

$$\text{AutoPEEP}_{\text{ES}} = (\text{PEEP}_{\text{ES}} - P_{\text{ES start}}) - (\text{PEEP}_{\text{AW}} - P_{\text{AW start}})$$

Range: 0 to 50 cmH₂O

Resolution: 1 cmH₂O

Note: Requires an esophageal balloon catheter.

Accuracy: $\pm 2\text{cmH}_2\text{O}$ or $\pm 5\%$, whichever is greater

Transpulmonary Pressure, Plateau (P_{tp Plat})

The ventilator is capable of calculating and displaying the Transpulmonary pressure during an inspiratory hold, which is the difference between the airway plateau pressure (P_{PLAT AW}) and the corresponding esophageal pressure.

$$P_{\text{tp Plat}} = P_{\text{PLAT AW}} - P_{\text{ES}}$$

Range: -60 to 120 cmH₂O

Resolution: 1 cmH₂O

Accuracy: $\pm 2\text{cmH}_2\text{O}$ or $\pm 5\%$, whichever is greater

Note:

Requires an inspiratory hold and an esophageal catheter.

Transpulmonary Pressure, AutoPEEP (P_{tp} PEEP)

Transpulmonary pressure, AutoPEEP (P_{tp} PEEP) is the difference between the corresponding airway and esophageal pressures at the end of the expiratory hold during an AutoPEEP maneuver.

$$P_{tp}PEEP = P_{AW} - P_{ES} \text{ (at the end of an expiratory hold)}$$

Range: -60 to 120 cmH₂O

Resolution: 1 cmH₂O

Accuracy: ± 2 cmH₂O or ± 5%, whichever is greater

Note: Requires an expiratory hold and an esophageal catheter.

Maximum Inspiratory Pressure (MIP)

Maximum Inspiratory Pressure (MIP), is the maximum negative airway pressure that is achieved by the patient, during an expiratory hold maneuver.

Range: -60 to 120 cmH₂O

Resolution: 1 cmH₂O

Accuracy: ± 2cmH₂O or ± 5%, whichever is greater

Respiratory Drive (P_{100})

Respiratory Drive (P_{100}), is the negative pressure that occurs 100 ms after an inspiratory effort has been detected.

$$P_{100} = P_{end\ 100} - PEEP_{AW}$$

Range: -60 to 120 cmH₂O

Resolution: 1 cmH₂O

Accuracy: ± 2cmH₂O or ± 5%, whichever is greater

Ventilator Work of Breathing (WOB_V)

Ventilator Work of Breathing (WOB_V), is defined as the summation of airway pressure (P_{AW}) minus the baseline airway pressure (PEEP_{AW}) times the change in tidal volume to the patient (ΔV) during inspiration, and normalized to the total inspiratory tidal volume (V_{ti}).

If P_{AW} > PEEP_{AW},

$$WOB_V = \frac{\sum_{Insp} (P_{AW} - PEEP_{AW}) \Delta V}{V_{ti}}$$

Range: 0.00 to 20.00 Joules/L

Resolution: 0.01 Joules/L

Accuracy: ± 10%

Patient Work of Breathing (WOB_P) (Normalized to Delivered Tidal Volume)

Patient Work of Breathing (WOB_P), normalized to the total inspiratory tidal volume. Patient work of breathing is defined as the summation of two work components: work of the lung and work of the chest wall.

$$WOB_P = WOB_{LUNG} + WOB_{CW}$$

$$\text{where } WOB_{LUNG} = \sum_{T_{start}}^{T_{end}} (PEEP_{ES} - P_{ES}) \Delta V \quad (\text{if } PEEP_{ES} > P_{ES} \text{ and } V > 0)$$

$$\text{and } WOB_{CW} = \frac{V_P^2}{2C_{CW}} \quad (\text{if } PEEP_{ES} > P_{ES})$$

Work of the lung (WOB_{LUNG}) is calculated using esophageal pressure when the baseline esophageal pressure (PEEP_{ES}) is greater than the esophageal pressure (P_{ES}), indicating patient effort.

Work of the chest wall (WOB_{CW}) for a spontaneously breathing patient is calculated using only the portion of the total tidal volume delivered due to a patient effort (V_P) and the chest wall compliance (C_{CW}).

Range: 0.00 to 20.00 Joules/L

Resolution: 0.01 Joules/L

Accuracy: ± 10%

Note:

Requires an esophageal balloon catheter.

Imposed Work of Breathing (WOB_I)

Imposed Work of Breathing (WOB_I), is defined as the work performed by the patient to breathe spontaneously through the breathing apparatus, i.e. the E.T. tube, the breathing circuit, and the demand flow system.

Imposed work is assessed by integrating the change in tracheal pressure and tidal volume, and normalizing the integrated value to the total inspiratory tidal volume (V_{ti}). (Requires the use of an optional tracheal catheter.) Based on the following formula:

$$WOB_I = \int_0^{V_{ti}} (PEEP_{AW} - P_{TR}) * \frac{dV}{dt},$$

where PEEP_{AW} = airway baseline pressure

P_{TR} = tracheal pressure

V_{ti} = inspired tidal volume

Range: 0.00 to 20.00 Joules/L

Resolution: 0.01 Joules/L

Accuracy: ± 10%

Note:

Requires a tracheal catheter

Appendix H: Capnometry Troubleshooting

Error Message	Corrective Action
CO ₂ Communication Error	<i>Medium-priority alarm.</i> Ensure the sensor is properly plugged in. Reinsert the sensor if necessary. If the error persists, call technical support.
CO ₂ Sensor Faulty	<i>Medium-priority alarm.</i> Ensure the sensor is properly plugged in. Reinsert the sensor if necessary. If the error persists, call technical support.
CO ₂ Sensor Over Temp	<i>Medium-priority alarm.</i> Ensure the sensor is not exposed to extreme temperatures, such as temperatures produced by lamps. If the error persists, call technical support.
CO ₂ Zero Required	<i>Medium-priority alarm.</i> Check airway adapter and clean if needed. If the error persists, perform an adapter zero procedure.
CO ₂ Out of Range	<i>Medium-priority alarm</i> when the CO ₂ measured by the sensor exceeds 150 mmHg (20.0 kPa). If the error persists, perform a zero procedure.
Check CO ₂ Airway Adapter	<i>Medium-priority alarm.</i> Check the airway adapter and clean it if needed. If the error persists, perform an adapter zero procedure.
Invalid EtCO ₂	<i>Medium-priority alarm.</i> No breaths are being detected by the CAPNOSTAT 5. Ensure spontaneous or mechanical breaths are being delivered to the patient. Confirm that the airway adapter is placed in the airway between any connector(s) and the circuit wye and that the sensor is firmly attached to the adapter.

This page intentionally left blank

Appendix I: Volumetric CO₂ Calculations

Note:

The AVEA assumes all gas passing through the sensor to be at BTPS (except during calibration check). Barometric pressure (PBar) is measured with an integrated barometric pressure sensor. Gas composition must be known by the CO₂ sensor and algorithms to ensure accurate reporting of PCO₂. The AVEA internally reports delivered gas composition data.

PCO₂

Partial pressure of carbon dioxide in the inhaled and exhaled gas measured continuously and reported by the CO₂ sensor at the wye. This is displayed graphically as the capnogram waveform.

EtCO₂

Peak partial pressure of carbon dioxide in exhaled gas reported by the CO₂ sensor at the wye. This is calculated for each breath and then averaged as specified by setup control EtCO₂ Averaging.

FCO₂

Fraction of carbon dioxide in the inhaled and exhaled gas measured continuously and reported by the CO₂ sensor at the wye. This value is used in the VCO₂ and dead space calculations but is not displayed.

$$FCO_2 = PCO_2 / (P_{Bar} + PEEP)$$

VCO₂

Minute volume of exhaled CO₂. It is measured continuously and averaged over a user-selectable time (VCO₂ Average: 3, 6, 9, 12 minutes).

$$VCO_2 = \left(\int_{t=(i-1\text{min})}^{t=i} \dot{V}_{wye} \cdot FCO_2 \cdot dt \right)$$

\dot{V}_{wye} is the flow at the wye, and is measured or calculated.

VtCO₂

Tidal volume of exhaled CO₂. It is measured over the period of each breath and averaged over a user-selectable time (VCO₂ Average: 3, 6, 9, 12 minutes).

$$V_t CO_2 = \left(\int_{T_{exp}} \dot{V}_{wye} \cdot FCO_2 \cdot dt \right)$$

FeCO₂

Percentage of carbon dioxide in the exhaled gas reported by the CO₂ sensor at the wye. This value is used in the dead space calculations but is not displayed.

$$FeCO_2 = VCO_2 / V_e$$

PeCO₂

Mean exhaled partial pressure of carbon dioxide in the exhaled gas reported by the CO₂ sensor at the wye. This value is used in the dead space calculations but is not displayed.

$$PeCO_2 = FeCO_2 \times (P_{Bar} + PEEP)$$

Physiologic Dead Space (Vd phy)

Comprises anatomic dead space (see below) as well as the volume of the respiratory zone (respiratory bronchioles, alveolar ducts and alveoli) not participating in gas exchange. The classic Bohr-Enghoff² equation is used to calculate physiologic dead space. This method uses arterial CO₂ (PaCO₂) as an estimator for alveolar CO₂ (PACO₂).

$$V_d phy = \bar{V}_t \cdot \left(1 - \frac{P_{eCO_2}}{P_{aCO_2}} \right)$$

Physiologic Dead Space / Tidal volume ratio (Vd phy / Vt)

Used to calculate the ratio of the tidal volume not participating in gas exchange (wasted ventilation).

$$\frac{V_d}{V_t} phy = \left(1 - \frac{P_{eCO_2}}{P_{aCO_2}} \right)$$

² Enghoff H: Volumen inefficax: Bemerkungen zur Frage des schädlichen Raumes. Upsalla Lakareforen Forhandl, 1938; 44:191-218.

Anatomic Dead Space (V_{d ana})

Total volume of the conducting airways from the nose to the level of the terminal bronchioles (areas that do not participate in gas exchange). Anatomic dead space also includes any mechanical dead spaces added to the ventilator circuit between the CO₂ sensor and the patient.

At end of each exhalation, calculation is carried out equivalent to the graphical method defined by Fowler³. The fraction of CO₂ in the exhaled gas is considered as a function of volume exhaled.

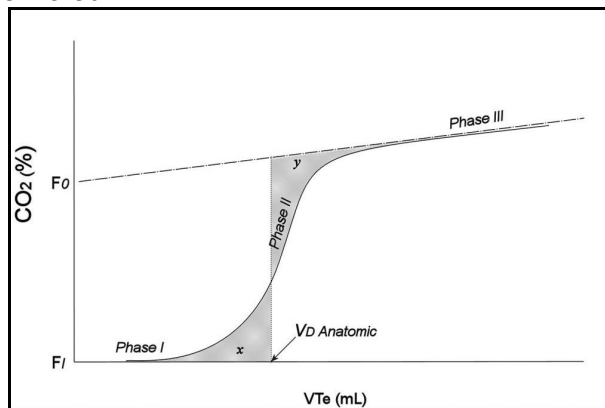

Using Fowler's nomenclature, phase I is the initial exhaled volume with constant FCO₂. FCO₂ during phase I is calculated as FI. Phase III is the linear part of the capnogram associated with exhalation of gas from the lung gas exchange units. This is calculated using linear regression over that part of the capnogram representing 30 to 70% of exhaled CO₂. The slope of phase III is calculated as m, with offset at the FCO₂ axis FO.

Shaded areas x and y are equal.

The volume above the capnogram and below the regression line through phase III is calculated as A.

Anatomical dead space is defined as that point on the volume axis at which the volumes shaded below and above the curve are equal. This is calculated using an algebraic method⁴

$$V_{d,ana} = \left(\frac{2 \cdot A}{(FO - FI) + \sqrt{(FO - FI)^2 + 2A \cdot m}} \right)$$

This parameter is calculated for each breath and then averaged over the same period as VCO₂.

If either phase I or phase III is ill-defined, based on variation of slope, then anatomical dead space is not calculated and this parameter is displayed as '***'.

3. Fowler W S, Lung Function Studies II: The Respiratory Dead Space, Am J Physiol 1948; 154: 405-416

4 Heller H, Könen-Bergmann M, Schuster K D, An Algebraic Solution to Dead Space Determination According to Fowler's Graphical Method, Comput Biomed Res 1999; 32: 161-167

Anatomic Dead Space / Tidal volume Ratio ($V_d \text{ ana} / V_t$)

Anatomic dead space / Tidal volume ratio is used to calculate the ratio of the tidal volume not participating in gas exchange (wasted ventilation). This is calculated on a breath to breath basis. $V_d \text{ phy} / V_t$ is probably more clinically relevant, but requires an arterial blood sample to be accurate.

Alveolar Dead Space

Alveolar dead space is (mathematically) the difference between physiological dead space and anatomical dead space. It represents the volume of the respiratory zone that is from ventilation of relatively under-perfused or non-perfused alveoli.

$$V_{d,alv} = (V_{d,phy} - V_{d,ana})$$

Alveolar Ventilation (V_A)

The minute volume of fresh gas that participates in gas exchange.

$$\dot{V}_A = Rate * (\bar{V}_T - V_{d,phy})$$

Oxygenation Index (OI)

Oxygenation index is a dimensionless number often used to assess the “pressure cost” of oxygenation. This parameter is calculated from the FI_{O_2} mean airway pressure and an arterial blood oxygen measurement entered by the clinician.

$$OI = \frac{(FI_{O_2} \cdot \bar{P}_{aw})}{PaO_2} \times 100$$

PA_{O_2} / FI_{O_2} Ratio (P/F)

The PA_{O_2} / FI_{O_2} ratio is a simple assessment of gas exchange. This parameter is calculated from the FI_{O_2} monitor value and an arterial blood oxygen measurement entered by the clinician.

$$P / F = \frac{PaO_2}{FI_{O_2}}$$

Note:

Because PA_{O_2} may be entered in either mmHg or kPa, the normal range for parameters OI and P/F differ depending on the setting of the CO_2 units control.

Appendix J: Electromagnetic Declarations

60601-1-2 IEC:2001 (E) Table 201

Guidance and manufacturer's declaration – electromagnetic emissions		
The AVEA Ventilator is intended for use in the electromagnetic environment specified below. The customer or the user of the AVEA Ventilator should assure that it is used in such an environment.		
Emissions test	Compliance	Electromagnetic environment - guidance
RF emissions CISPR 11	Group 1	The AVEA Ventilator uses RF energy only for its internal function. Therefore, its RF emissions are very low and are not likely to cause any interference in nearby electronic equipment.
RF emissions CISPR 11	Class B	The AVEA Ventilator is suitable for use in all establishments, including domestic establishments and those directly connected to the public low-voltage power supply that supplies buildings used for domestic purposes.
Harmonic emissions IEC 61000-3-3	Class A	
Voltage Fluctuation/ Flicker emissions IEC 61000-3-3	Complies	

60601-1-2 IEC:2001 (E) Table 202

Guidance and manufacturer's declaration - electromagnetic immunity			
The AVEA Ventilator is intended for use in the electromagnetic environment specified below. The customer or the user of the AVEA Ventilator should assure that it is used in such an environment.			
Immunity Test	IEC 60601 Test level	Compliance level	Electromagnetic environment - guidance
Electrostatic discharge (ESD) IEC 61000-4-2	± 6 kV contact ± 8 kV air	± 6 kV contact ± 8 kV air	Floors should be wood, concrete, or ceramic tile. If floors are covered with synthetic material, the relative humidity should be at least 30%.
Electrical fast transient/burst IEC 61000-4-4	± 6 kV for power supply lines ± 1 kV for input/output lines	± 6 kV for power supply lines ± 1 kV for input/output lines	Mains power quality should be that of a typical commercial or hospital environment.
Surge IEC 61000-4-5	± 1 kV differential mode ± 2 kV common mode	± 1 kV differential mode ± 2 kV common mode	Mains power quality should be that of a typical commercial or hospital environment.
Voltage dips, short interruptions and voltage variations on power supply input lines IEC 61000-4-11	<5 % U_T (>95% dip in U_T) for 0,5 cycle 40 % U_T (60 % dip in U_T) for 5 cycles 70 % U_T (30 % dip in U_T) for 25 cycle <5 % U_T (>95% dip in U_T) for 5 seconds	<5 % U_T (>95% dip in U_T) for 0,5 cycle 40 % U_T (60 % dip in U_T) for 5 cycles 70 % U_T (30 % dip in U_T) for 25 cycle <5 % U_T (>95% dip in U_T) for 5 seconds	Mains power quality should be that of a typical commercial or hospital environment. Compliance is dependent on the operator following recommended charging and maintenance of the installed battery backup.
Power frequency (50/60 Hz) magnetic field IEC 61000-4-8	3 A/m	3 A/m	Power frequency magnetic fields should be at level characteristic of a typical location in a typical commercial or hospital environment.
NOTE U_T is the a.c. mains voltage prior to application of the test level.			

60601-1-2 IEC:2001 (E) Table 203

Guidance and manufacturer's declaration - electromagnetic immunity			
The AVEA Ventilator is intended for use in the electromagnetic environment specified below. The customer or the user of the AVEA Ventilator should assure that it is used in such an environment			
Immunity Test	IEC 60601 Test level	Compliance level	Electromagnetic environment - guidance
Conducted RF IEC 61000-4-6	3 Vrms 150 kHz to 80 MHz outside ISM bands ^a	3 V	Portable and mobile RF communications equipment should be used no closer to any part of the AVEA Ventilator, including cables, than the recommended separation distance calculated from the equation applicable to the frequency of the transmitter. Recommended separation distance $d = 1.16\sqrt{P}$ $d = 1.20\sqrt{P}$
	10 Vrms 150 kHz to 80 MHz In ISM bands ^a	10 V	
Radiated RF IEC 61000-4-3	10 V/m 80 MHz to 2,5 GHz	10 V/m	$d = 1.2\sqrt{P}$ 80 MHz to 800 MHz $d = 2.3\sqrt{P}$ 800 MHz to 2.5 GHz
			Where P is the maximum output power rating of the transmitter in watts (W) according to the transmitter manufacturer and d is the recommended separation distance in metres (m). ^b Field strengths from fixed RF transmitters, as determined by an electromagnetic site survey, ^c should be less than the compliance level in each frequency range. ^d Interference may occur in the vicinity of equipment marked with the following symbol: 
NOTE 1 At 80 MHz and 800 MHz, the higher frequency range applies.			
NOTE 2 These guidelines may not apply in all situations. Electromagnetic propagation is affected by absorption and reflection from structures, objects and people.			
^a The ISM (industrial, scientific, and medicinal) bands between 150 kHz and 80 MHz are 6,765 MHz to 6,795 MHz; 13,553 MHz to 13,567 MHz; 26,957 MHz to 27, 283 MHz; and 40,66 MHz to 40,70 MHz. ^b The compliance levels in the ISM frequency bands between 150 kHz and 80 MHz and in the frequency range 80 MHz to 2,5 GHz are intended to decrease the likelihood that mobile/portable communications equipment could cause interference if it is inadvertently brought into patient areas. For this reason, an additional factor of 10/3 is used in calculating the recommended separation distance for transmitters in these frequency ranges. ^c Field strengths from fixed transmitters, such as base stations for radio (cellular/cordless) telephones and land mobile radios, amateur radio, AM and FM radio broadcast and TV broadcast cannot be predicted theoretically with accuracy. To assess the electromagnetic environment due to fixed FR transmitters, an electromagnetic site survey should be considered. If the measured field strength in the location in which the AVEA Ventilator is used exceeds the applicable RF compliance level above, the AVEA Ventilator should be observed to verify normal operation. If abnormal performance is observed, additional measures may be necessary, such as reorienting or relocating the AVEA Ventilator. ^d Over the frequency range 150 kHz to 80 MHz, field strengths should be less than 3 V/m.			

60601-1-2 IEC:2001 (E) Table 205

Recommended separation distance between portable and mobile RF communications equipment and the AVEA Ventilator

The AVEA Ventilator is intended for use in an electromagnetic environment in which radiated RF disturbances are controlled. The customer or the user of the AVEA Ventilator can help prevent electromagnetic interference by maintaining a minimum distance between portable and mobile RF communications equipment (transmitters) and the AVEA Ventilator as recommended below, according to the maximum output power of the communications equipment.

Rated maximum output power of transmitter W	Separation distance according to frequency of transmitter m			
	150 kHz to 80 MHz outside ISM bands	150 kHz to 80 MHz in ISM bands	80 MHz to 800 MHz	80 MHz to 800 MHz
	$d = 1.16\sqrt{P}$	$d = 1.20\sqrt{P}$	$d = 4\sqrt{P}$	$d = 7.66\sqrt{P}$
0,01	0.12	0.12	0.12	0.23
0,1	0.37	0.38	0.38	0.73
1	1.16	1.20	1.20	2.30
10	3.67	3.79	3.79	7.27
100	11.60	12.00	12.00	23.00

For transmitters rated at a maximum output power not listed above, the recommended separation distance d in metres (m) can be determined using the equation applicable to the frequency of the transmitter, where P is the maximum output power rating of the transmitter in Watts (W) according to the transmitter manufacturer.

NOTE 1 At 80 MHz and 800 MHz, the separation distance of the higher frequency range applies.

NOTE 2 The ISM (industrial, scientific, and medical) bands between 150 kHz and 80 MHz are 6,765 MHz to 6,795 MHz; 13,553 MHz to 13,567 MHz; 26,957 MHz to 27,283 MHz; and 40,66 MHz to 40,70 MHz.

NOTE 3 An additional factor of 10/3 is used in calculating the recommended separation distance for transmitters in the ISM frequency bands between 150 kHz and 80 MHz and in the frequency range 80 MHz to 2,5 GHz to decrease the likelihood that mobile/portable communications equipment could cause interference if it is inadvertently brought into patient areas.

NOTE 4 These guidelines may not apply in all situations. Electromagnetic propagation is affected by absorption and reflection from structures, objects and people.

Appendix K: Glossary

Breath Interval	<i>Elapsed time from the start of one breath to the start of the next.</i>
Preset	<i>An operator set ventilator parameter.</i>
Trigger	<i>Value at which the ventilator initiates delivery of a breath as a result of measured patient effort.</i>
BTPS	<i>Body Temperature at Ambient Pressure, Saturated.</i>
ATPD	<i>Ambient Temperature, Ambient Pressure, Dry.</i>
Demand Flow	<i>The flow generated by the ventilator to meet the patient's flow demand in order to maintain PEEP at the preset level.</i>
AC	<i>Alternating Current (mains electricity).</i>
Bias Flow	<i>Flow through the patient breathing circuit during the expiratory phase. This flow is used for flow triggering.</i>
bpm	<i>Breaths per minute.</i>
Breath Period	<i>The length of time between machine-initiated breaths. Depends on the Breath Rate setting.</i>
Breath Rate	<i>The number of breaths delivered in a minute.</i>
BTPD	<i>Body Temperature at Ambient Pressure, Dry</i>
Button	<i>A push button switch used to toggle a function on or off.</i>
cmH₂O	<i>Centimeters of water pressure.</i>
Controls	<i>Any button, switch, or knob that allows you to modify the ventilator's behavior.</i>
Event	<i>The occurrence or activation of certain controls or functions of the ventilator or a patient care activity, which can be stored in the trend buffer.</i>
Flow	<i>The rate at which gas is delivered. Measured in liters per minute (L/min).</i>
Indicators	<i>A visual element showing operational status.</i>
L	<i>Liters. A unit of volume.</i>
LED	<i>Light Emitting Diode</i>
L/min	<i>Liters per minute. A unit of flow.</i>
Mode	<i>An operating state of the ventilator that determines the allowable breath types.</i>
Monitored Parameter	<i>A measured value displayed in the monitor window.</i>
O₂	<i>Oxygen</i>
Patient Breathing Circuit	<i>The tubing that provides the ventilatory interface between the patient and ventilator.</i>
Paw	<i>Airway Pressure. Measured in cmH₂O.</i>
PEEP	<i>Positive End Expiratory Pressure. Pressure maintained in the circuit at the end of exhalation.</i>
P_{peak}	<i>Peak Inspiratory Pressure. Shows the highest circuit pressure to occur during inspiration. The display is updated at the end of inspiration. P_{peak} is not updated for spontaneous breaths.</i>

Pplat	<i>Plateau Pressure. Measured during an Inspiratory Hold maneuver or during zero flow in a pressure control breath. Used to calculate Static Compliance (Cstat).</i>
PSIG	<i>Pounds per square inch gauge. 1 PSIG = .07bar</i>
Sigh Breath	<i>A Volume Controlled machine breath having a tidal volume equal to one-and-a-half times (150%) of the current tidal volume setting.</i>
WOB	<i>Patient Work of Breathing i.e. a measure of Patient Effort.</i>

Index

A

access the advanced settings group · 96
 active humidifier · 16
 adult patient circuit · 16
 advanced settings · 96
 accessing the screen · 96
 advanced settings indicator · 96
 bias flow · 101
 flow cycle · 100
 insp rise · 100
 machine volume · 99
 pres trig · 101
 PSV cycle · 103
 PSV rise · 102
 PSV Tmax · 103
 sigh · 101
 volume limit · 98
 Vsync · 102
 Vsync rise · 102
 waveform · 100
 air inlet pressure · 126, 214
 air supply · 7
 alarm conditions · 178
 alarm indicator · 170
 alarm indicators · 58
 alarm limits · 171
 alarm loudness · 28
 alarm reset button · 172
 alarm silence · 172
 alarm types · 172
 alarms · 170
 apnea interval · 177
 extended high peak pressure · 175
 fan failure · 173
 high exhaled minute volume · 176
 high O₂ percent · 178
 high peak pressure, normal · 174
 high peak pressure, sigh · 174
 high priority · 170
 high rate · 177
 high tidal volume · 177
 IE ratio · 177
 loss of air · 173
 loss of gas supply · 173
 loss of O₂ · 173

 low exhaled minute volume · 176
 low O₂ percent · 178
 low peak pressure · 174
 low PEEP · 175
 low priority · 170
 maximum inspiratory time · 177
 medium priority · 170
 safety valve open · 172
 vent inop · 172
 annual maintenance · 190
 apnea backup
 CPAP or APRV / BIPHASIC · 84
 apnea back-up ventilation · 66
 Artificial Airway Compensation · 61
 assemble and insert the exhalation filter and water trap · 9
 assembly on site · 7
 assist control ventilation mode · 78
 attaching the flow sensors · 18
 attaching the patient circuit · 16

B

Backup Alarm · 170
 base flow · 101
 battery cord · 9
 battery pack · 191
 external · 191
 battery replacement · 192
 battery status indicator · 168
 battery status indicators · 193
 bias flow · 95, 101, 241
 breath interval · 55, 78, 79, 92
 breath interval timing mechanism · 78
 breath rate · 78, 79, 92, 125, 130, 177, 179, 213
 breath type and delivery mode · 66
 breath types · 74, 79, 241
 breath types and modes by patient size
 adult and pediatric · 89
 breaths, defined by four variables · 74

C

calculated IE Ratio · 130
 calculated minute volume · 130
 cautions · x
 choice of waveforms · 106
 circuit compliance · 3, 62

circuit compliance compensation · 3, 62
 Circuit Occlusion Alarm · 42
 cleaning and sterilization
 accessories and parts · 187
 external surfaces · 187
 colors on waveform display · 105
 compliance effect of the circuit · 3, 62
 compressed gas sources · 7
 connecting the O2 sensor · 25
 contacting the manufacturer · 197
 control knob · 106, 107, 124, 132, 172
 controls associated with each breath type & mode · 97
 cord routing · 9
 CPAP/PSV mode · 66, 76, 82
 customer service · 198

D

data dial · 91
 default mode for all patient types · 78
 demand breaths · 76
 disable the audible alarm · 172
 displayed value · 91
 dynamic compliance · 126, 214

E

electromagnetic components · vii
 Enable/Disable O2 Alarms · 28
 esophageal balloon · 23
 connection · 23
 event log · 128
 event markers · 128
 events · 128
 events automatically recorded · 128
 exhalation filter · 9, 10, 11, 187
 exhaled tidal volume · 213
 adjusted for ideal body weight · 213
 expiratory Time · 125, 214
 expired tidal volume · 125
 adjusted for patient weight · 125
 external battery · 38, 192
 external water trap · 25

F

flashing alarms · 170
flow cycle · 100
 flow trig · 90

freezing a loop · 109
 freezing the loops screen · 109
 fuses · 195

G

gas line pressure · 7
 gas sources · 7
 air supply · 7
 oxygen supply · 7
 graphs · 107

H

Heliox connection · 26
 heliox delivery · 4
 high priority alarm · 170
 hot wire sensor · 18
 humidification · 4, 16, 63

I

independent lung ventilation · 29, 30, 104
 indicators · 167
 external battery · 167
 internal battery · 167
 mains AC · 167
 inhaled tidal volume · 213
 adjusted for ideal body weight · 213
 insp pause · 90
 insp pres · 90
insp rise · 100
 insp time · 90
inspiratory pause · 93
 inspiratory pressure · 92
 inspiratory time · 93, 125, 214
 Inspiratory/Expiratory ratio · 125, 214
 inspired tidal volume · 125
 adjusted for patient weight · 125
 internal battery · 38, 192

L

leak compensation · 62
 loops
 colors · 105
 comparing loops · 109
 freezing a loop · 109
 reference · 109

reference loops · 109
 saving a loops · 109
 selection · 108
 loops in real time · 108
 loops screen · 108
 low priority alarm · 170

M

mach vol · 99
 main screen monitors · 132
 mandatory breath · 74
 mandatory tidal volume · 125, 213
 adjusted for patient weight · 125, 213
 mean inspiratory pressure · 126, 214
 medium priority alarm · 58, 170
 membrane button
 expiratory hold · 55
 membrane buttons
 accept button · 54
 advanced settings · 56
 alarm limits · 53
 alarm reset · 52
 alarm silence · 52
 cancel · 54
 freeze · 57
 increase O₂ · 53
 inspiratory hold · 55
 main · 58
 manual breath · 53
 mode · 56
 nebulizer · 55
 panel lock · 56
 print · 56
 screens · 58
 setup · 56
 suction · 53
 membrane buttons and LEDs · 52
 minute volume · 125, 213
 adjusted for patient weight · 125, 213
 monitor screen · 124
 monitored values · 124
 monitored values choices · 125
 multiple alarms · 170

N

nebulizer · 21, 55
 neonatal patient circuit · 17
 new patient key · 59

NIST fittings · 25

O

O₂ percentage · 90
 optional external battery · 9
 ordering parts · 197
 oxygen inlet pressure · 126, 214
 oxygen sensor · 24
 cable · 25
 cell · 25
 oxygen supply · 7

P

passive humidifier or HME · 16
 patient effort · 78, 79, 241
 patient ID · 63
 patient select screen · 59
 patient size · 3
 patient size indicators · 55
 patient size select screen · 60
 patient-triggered breaths · 76
 peak Expiratory flow rate · 126, 214
 peak flow · 90
 peak Inspiratory flow rate · 126, 214
 peak inspiratory pressure · 125, 214
 PEEP · 75, 76, 90, 92, 94, 101, 126, 172, 174, 175, 178,
 179, 214, 241
 percent leakage · 125, 213
 percentage of oxygen · 126, 214
 plateau pressure · 126, 214
 positive end expiratory pressure · 94, 126, 214
 power cord · 38
 power on indicator · 167
 power source · 7
 pres high · 90, 95
 pres low · 90
pres trig · 101
 pressure breaths · 75, 155
 pressure high control · 95
 pressure low control · 96
 pressure regulated volume control breaths · 75
 pressure support ventilation · 82
 preventive maintenance · 190
 primary breath controls · 90, 92
 breath rate · 92
 flow trigger · 95
inspiratory pause · 93
 inspiratory pressure · 92

inspiratory time · 93
PEEP · 94
 pressure high · 95
 pressure low · 96
 pressure support · 93
 tidal volume · 92
 time high · 95
 time low · 96
 printing · 107
 protective ground connection · 38
 PSV · 90
 PSV breath · 76
 PSV control · 93
 PSV cycle · 76, 103
PSV rise · 102
 PSV Tmax · 76, 103

R

rapid shallow breathing index · 125, 214
 rate · 90
 rear panel diagram · 24
 reference loop · 109
 remote nurse call system · 37
 replaceable fuses · 194
 respiratory system resistance · 126, 214
 resume button · 88
 resume current key · 59

S

safety information · ix
 save loop button · 109
 saving a loop · 109
 scaling histograms · 129
 screen select box · 87
 screens

- mode selection · 66
- patient select · 59
- patient size · 60
- ventilation setup · 61

 sequence in which the power sources are used · 192
 service calls · 197
 Setting Date · 37
 setting the breath type and ventilation mode · 66
 Setting the Language · 31
 Setting the Time · 37
 setting up your AVEA ventilator · 7
 sigh · 101, 174, 178
 sigh volume breaths · 101

SIMV mode · 79
 smart connectors

- attachment · 26

 smart Heliox connectors · 26
 specifications

- accessories · 209
- atmospheric & environmental · 208
- data input & output · 203
- electrical · 201
- physical dimensions · 209
- pneumatic · 201

 spontaneous breath · 77
 spontaneous breath rate · 125, 213
 spontaneous minute volume · 125, 213

- adjusted for patient weight · 125, 213

 spontaneous tidal volume · 125, 213

- adjusted for ideal body weight · 213
- adjusted for patient weight · 125

 standby mode · 87
 static compliance · 126, 214
 status indicators · 167
 symbols · xi
 synchronized intermittent mandatory ventilation · 79

T

tidal volume · 92
 time cycled pressure limited breaths · 75
 time high · 90, 95

- control · 95

 time low · 90, 96

- control · 96

 tracheal catheter · 23
 trended data · 129

- histograms · 129
- spreadsheet · 129

 trends screen · 129

V

variable orifice sensor · 20
 ventilation modes · 78
 ventilator specifications · 201
 ventilator synchronization · 29
 visual alarm display · 170
 volume breaths · 74
 volume limit · 75, 98
 Vsync · 102

- pressure control breaths · 102
- volume test breath · 102

Vsync rise · 102
Vt · 90

W

warnings · ix
warranty · iv
water collection bottle · 9
water trap · 9, 10, 187

waveform · 93, 100, 106, 107, 132
 choices · 107
waveforms
 colors · 105
 freeze · 107
 freezing · 105
 main screen · 105
 menu · 106
 printing · 107

This page intentionally left blank.