

HAMILTON-C6

Operator's Manual

REF 160021

Software version 1.2.x
624945/04 | 2022-03-31

CE 0197

HAMILTON
MEDICAL

Operator's Manual

HAMILTON-C6

2022-03-31

624945/04

© 2021 Hamilton Medical AG. All rights reserved. Printed in Switzerland.

No part of this publication may be reproduced, stored in a database or retrieval system, or transmitted in any form or by any means, electronic, mechanical, or by photocopying, recording, or otherwise, without prior written permission of Hamilton Medical AG.

This document may be revised, replaced, or made obsolete by other documents by Hamilton Medical AG at any time and without notice. Ensure that you have the most current applicable version of this document; if in doubt, contact the technical support department of Hamilton Medical AG, Switzerland. While the information set forth herein is believed to be accurate, it is not a substitute for the exercise of professional judgment.

Nothing in this document shall limit or restrict in any way Hamilton Medical AG's right to revise or otherwise change or modify the equipment (including its software) described herein, without notice. In the absence of an express, written agreement to the contrary, Hamilton Medical AG has no obligation to furnish any such revisions, changes, or modifications to the owner or user of the equipment (including software) described herein.

The equipment must be operated, serviced, or upgraded only by trained professionals. Hamilton Medical AG's sole responsibility with respect to the equipment and its use is as stated in the limited warranty provided in the device *Operator's Manual*.

Hamilton Medical AG shall not be liable for any loss, cost, expense, inconvenience, or damage that may arise out of misuse of the product, or if non-Hamilton Medical AG parts were used when replacing parts, or if serial numbers were amended, deleted, or removed.

If returning parts to Hamilton Medical AG, be sure to use the standard Hamilton Medical returned goods authorization (RGA) procedure. Disposal of parts shall follow all local, state, and federal regulation with respect to environmental protection.

Hamilton Medical AG will make available, on request, circuit diagrams, component parts lists, descriptions, calibration instructions, or other information that will assist appropriately trained personnel to repair those parts of the equipment designated by Hamilton Medical AG to be repairable.

For all proprietary and third-party trademarks used by Hamilton Medical AG, see www.hamilton-medical.com/trademarks.

Manufacturer

Hamilton Medical AG
Via Crusch 8, CH-7402 Bonaduz
Switzerland
Phone: (+41) 58 610 10 20
info@hamilton-medical.com
www.hamilton-medical.com

	Preface	17
Chapter 1	Safety information	21
1.1	Overview.....	22
1.2	Electromagnetic susceptibility.....	22
1.3	Fire and other hazards.....	23
1.4	General operation and setup.....	23
1.4.1	General operation and setup.....	23
1.4.2	Electrical: power and batteries.....	25
1.4.3	Gas supply	25
1.4.4	USB ports.....	26
1.5	Setting up for ventilation.....	26
1.5.1	Patient breathing circuits, components, and accessories	26
1.5.2	Preoperational check and tests	27
1.5.3	Humidifier.....	27
1.5.4	IntelliCuff.....	28
1.5.5	CO2 sensor setup and operation	28
1.5.6	Nebulization.....	30
1.6	Ventilating the patient	31
1.6.1	Specifying patient settings.....	31
1.6.2	Neonatal ventilation	31
1.6.3	Apnea backup.....	32
1.6.4	TRC settings.....	32
1.6.5	P/V Tool Pro	32
1.6.6	Noninvasive ventilation.....	33
1.6.7	Using high flow oxygen therapy.....	33
1.7	Monitoring and alarms.....	33
1.8	Using the trolley.....	34
1.9	Maintenance.....	34
1.9.1	General maintenance, cleaning, and disinfection.....	35

1.9.2	Preventive maintenance	36
1.9.3	O2 sensor	36
1.10	Service and testing	37
Chapter 2	System overview	39
2.1	Overview	40
2.1.1	Standard features and options	40
2.2	Physical descriptions	43
2.2.1	About the ventilator	44
2.2.2	About the main display	49
2.2.3	About the patient breathing circuits	50
2.2.4	About the trolley and mounting variations	55
2.2.5	Adjusting the monitor	55
2.2.6	Connecting a remote monitor to the DVI port	56
2.3	Navigating the windows and controls	57
2.3.1	Accessing windows	57
2.3.2	Adjusting controls	58
2.3.3	Selecting list items	59
2.3.4	Using shortcuts	59
Chapter 3	Preparing the ventilator	61
3.1	Overview	62
3.2	Connecting to a power source	62
3.2.1	Using battery power	62
3.3	Connecting the oxygen supply	63
3.4	Setting up the patient breathing circuit	64
3.4.1	Breathing circuit connections on the ventilator	64
3.4.2	Working with the expiratory valve set	65
3.4.3	Selecting the breathing circuit components	65
3.4.4	Assembling the patient breathing circuit	67

3.4.5	Positioning the breathing circuit	68
3.4.6	Changing breathing circuit components during ventilation	68
3.5	Setting up esophageal/transpulmonary pressure monitoring	68
3.6	Turning the ventilator on and off	69
Chapter 4	Setting up external devices and sensors	71
4.1	Overview	72
4.2	Setting up a humidifier	72
4.3	Setting up the IntelliCuff cuff pressure controller	73
4.3.1	About the IntelliCuff tubing	73
4.3.2	Setting up IntelliCuff	73
4.4	Setting up CO2 monitoring	74
4.4.1	Mainstream CO2 measurement	74
4.4.2	Sidestream CO2 measurement	76
4.5	Setting up SpO2 monitoring	77
4.6	Enabling sensors	78
4.7	Setting up nebulization	78
4.7.1	Selecting the nebulization type	79
4.7.2	Setting up a pneumatic nebulizer	79
4.7.3	Setting up an Aerogen nebulizer	79
4.8	Connecting to external devices	80
Chapter 5	Specifying ventilation settings	81
5.1	Process overview	82
5.2	Selecting the patient group	82
5.2.1	About Quick setups: preconfigured settings	83
5.3	Entering patient data	83
5.4	Performing the preoperational check, tests, and calibrations	84
5.4.1	Performing the preoperational check	85
5.4.2	Performing the breathing circuit Leak test	86
5.4.3	Calibrating the adult/pediatric flow sensor	87

5.4.4	Calibrating the O2 sensor.....	88
5.4.5	Performing a zero calibration of the CO2 sensor/adapter.....	89
5.4.6	Testing the alarms.....	91
5.5	Selecting the ventilation mode	91
5.5.1	Reviewing and adjusting ventilation settings.....	92
5.5.2	About Plimit and related pressure-control settings.....	93
5.5.3	About the trigger types	96
5.5.4	About Apnea backup ventilation	101
5.5.5	About tube resistance compensation (TRC)	102
5.6	Setting alarm limits	104
5.6.1	About the Oxygen alarm limits	107
5.7	Starting ventilation.....	107
5.8	Stopping ventilation	108
5.9	About the control parameters	108
Chapter 6	Specifying neonatal settings.....	115
6.1	Setting up for neonatal ventilation	116
6.1.1	Setting the patient group and weight.....	116
6.1.2	Setting up the patient breathing circuit	117
6.2	Performing the preoperational check, tests, and calibrations	119
6.2.1	Calibrating the neonatal flow sensor	120
6.3	Selecting the ventilation mode	121
6.4	Setting the patient weight for ventilation	122
6.5	Alarms for neonatal ventilation	122
6.6	O2 enrichment for neonates	122
Chapter 7	Ventilation modes.....	123
7.1	Overview.....	124
7.1.1	Breath types and timing options.....	124
7.1.2	Ventilation modes.....	125

7.2	Volume-controlled modes, flow control.....	129
7.2.1	(S)CMV mode	129
7.2.2	SIMV mode	130
7.3	Volume-targeted modes, adaptive pressure control	132
7.3.1	APVcmv / (S)CMV+ mode.....	133
7.3.2	APVsimv / SIMV+ mode.....	134
7.4	Pressure-controlled modes	135
7.4.1	PCV+ mode	136
7.4.2	PSIMV+ mode	137
7.4.3	PSIMV+ mode with PSync	138
7.4.4	DuoPAP mode.....	139
7.4.5	APRV mode.....	140
7.4.6	SPONT mode.....	141
7.5	Intelligent Ventilation	142
7.5.1	ASV mode.....	142
7.5.2	INTELLiVENT-ASV mode	144
7.6	Noninvasive modes	145
7.6.1	NIV mode.....	145
7.6.2	NIV-ST mode.....	146
7.6.3	nCPAP-PS mode.....	147
7.6.4	High flow oxygen therapy	148
7.7	Special conditions	150
7.7.1	Sensor Failure mode.....	150
7.7.2	Safety ventilation	150
7.7.3	Ambient state	151
7.7.4	Display and communication error states	151
7.8	Working with noninvasive modes.....	152
7.8.1	Required conditions for use.....	152
7.8.2	Contraindications.....	153
7.8.3	Potential adverse reactions.....	153

7.8.4	Control settings in noninvasive ventilation	153
7.8.5	Alarms in noninvasive ventilation.....	154
7.8.6	Monitored parameters in noninvasive ventilation.....	154
7.8.7	Additional notes about using noninvasive ventilation.....	155
7.9	Working with ASV	156
7.9.1	Contraindications.....	156
7.9.2	Setting up ASV on the ventilator	156
7.9.3	Clinical workflow with ASV	157
7.9.4	Maintaining adequate ventilation	158
7.9.5	Reviewing alarm settings.....	158
7.9.6	Monitoring ASV	159
7.9.7	Weaning.....	160
7.9.8	Functional overview	161
Chapter 8	Monitoring ventilation	167
8.1	Overview.....	168
8.2	Viewing numeric patient data	168
8.2.1	About the main monitoring parameters (MMP)	168
8.2.2	About the secondary monitoring parameters (SMPs)	169
8.2.3	Viewing patient data in the Monitoring window	170
8.3	Viewing graphical patient data.....	171
8.3.1	Selecting a display layout	171
8.3.2	Selecting display options	172
8.3.3	Working with waveforms.....	173
8.3.4	Working with Trend graphs.....	176
8.3.5	Working with loops.....	177
8.4	Working with Intelligent panels.....	178
8.4.1	Dynamic Lung panel: real-time ventilation status.....	178
8.4.2	Vent Status panel: real-time ventilator dependence status.....	181
8.4.3	ASV Graph panel: real-time patient condition and targets.....	183

8.5	Monitoring transpulmonary/esophageal pressure	183
8.6	About the monitored parameters	184
8.7	Viewing patient ventilation time	193
8.8	Viewing device-specific information	194
Chapter 9	Responding to alarms	195
9.1	Overview	196
9.1.1	Alarm limit indicators	201
9.1.2	Responding to an alarm	201
9.1.3	Temporarily silencing an alarm	202
9.2	About the alarm buffer	203
9.2.1	Accessing on-screen troubleshooting help	204
9.3	Adjusting alarm loudness (volume)	204
9.4	Troubleshooting alarms	205
9.5	Working with a distributed alarm system (DAS)	225
9.5.1	Enabling Global AUDIO OFF	225
9.5.2	About DAS-related alarms	226
Chapter 10	Ventilation settings and functions	229
10.1	Overview	230
10.2	Accessing settings during ventilation	230
10.2.1	Accessing patient data during ventilation	230
10.2.2	Accessing settings during ventilation	231
10.3	Entering/exiting Standby	231
10.4	Oxygen enrichment	233
10.4.1	Performing an open-suctioning maneuver	233
10.4.2	About closed-suctioning maneuvers	234
10.5	Manual breath	234
10.6	Inspiratory and expiratory hold	235
10.6.1	Inspiratory hold	235
10.6.2	Expiratory hold	235

10.7	Working with a nebulizer	236
10.7.1	Specifying duration and synchronization settings.....	236
10.7.2	Working with a pneumatic nebulizer.....	237
10.7.3	Working with an Aerogen nebulizer.....	238
10.8	Locking and unlocking the touch screen.....	238
10.9	Capturing a screenshot	239
10.10	Setting display options	239
10.10.1	Setting date and time.....	239
10.10.2	Day and night display brightness.....	240
10.11	About the Event log.....	241
10.11.1	Copying event log data	241
Chapter 11	Working with P/V Tool	243
11.1	Overview.....	244
11.1.1	Conditions for use.....	244
11.1.2	Indications for use.....	245
11.1.3	Contraindications for use	245
11.2	Using the P/V Tool.....	245
11.3	Opening the P/V Tool	246
11.4	Adjusting the control settings.....	247
11.5	Performing a P/V Tool maneuver	248
11.5.1	Viewing data.....	248
11.5.2	Choosing the data to display.....	249
11.6	Analyzing the data	251
11.7	Using reference curves	251
11.8	Performing a recruitment maneuver	252

Chapter 12	Working with external devices.....	253
12.1	Working with the HAMILTON-H900 humidifier	254
12.1.1	Accessing humidifier controls on the ventilator.....	255
12.1.2	About the humidification modes	256
12.1.3	Changing humidity using temperature controls.....	258
12.1.4	Entering Standby.....	259
12.1.5	Turning the humidifier on/off	259
12.1.6	About humidifier-related alarms.....	260
12.1.7	About humidifier-related parameters.....	263
12.2	Working with IntelliCuff.....	264
12.2.1	Accessing IntelliCuff controls on the ventilator	264
12.2.2	Turning IntelliCuff on and off.....	266
12.2.3	About IntelliCuff modes.....	267
12.2.4	Setting the cuff pressure	268
12.2.5	Performing a hold	270
12.2.6	Deflating the cuff.....	270
12.2.7	About IntelliCuff-related alarms	271
12.2.8	About IntelliCuff-related parameters	274
12.2.9	Last Patient settings with IntelliCuff.....	275
Chapter 13	Maintenance.....	277
13.1	Overview.....	278
13.2	Cleaning, disinfection, and sterilization	278
13.3	Preventive maintenance	282
13.4	Performing maintenance tasks	283
13.4.1	Maintaining the filters	283
13.4.2	Removing the side cover	284
13.4.3	Replacing the galvanic O2 sensor	284

13.4.4	Charging and storing batteries	285
13.4.5	Replacing batteries	285
13.5	Repacking and shipping	285
Chapter 14	Configuration	287
14.1	Overview	288
14.2	Accessing Configuration mode.....	288
14.3	Configuring general settings	288
14.3.1	Selecting the default language	288
14.3.2	Selecting the units of measure	288
14.3.3	Enabling the communication interface	288
14.3.4	Setting the minimum alarm loudness (volume)	289
14.3.5	Setting sensitivity for Check flow sensor for water alarm	289
14.3.6	Setting oxygen alarm limits manually.....	289
14.3.7	Setting the maximum available Flow in HiFlowO2 for neonates.....	290
14.4	Selecting mode options.....	290
14.4.1	Setting breath timing options.....	290
14.4.2	Choosing the mode naming convention.....	290
14.4.3	Choosing the ASV version	290
14.4.4	Enabling TI max for invasive modes	291
14.5	Configuring MMPs and SMPs.....	291
14.6	Defining Quick setups	291
14.6.1	Configuring individual setup settings.....	291
14.6.2	Selecting a default Quick setup	292
14.7	Activating Aerogen	293
14.8	Activating SpO2 and CO2 measurement	293
14.9	Copying configuration settings.....	293

14.10	Configuring device options	293
14.10.1	Adding software options.....	293
14.10.2	Activating hardware options	294
14.10.3	Removing options	294
Chapter 15	Parts and accessories.....	297
15.1	Overview.....	298
Chapter 16	Specifications.....	305
16.1	Physical characteristics.....	306
16.2	Environmental requirements.....	308
16.3	Pneumatic specifications	309
16.4	Electrical specifications	310
16.5	Control settings	312
16.6	Monitored parameters	318
16.7	Alarms	326
16.8	Configuration	329
16.9	ASV technical data	332
16.10	Ventilator breathing system specifications	334
16.11	Technical performance data	335
16.11.1	Accuracy testing.....	341
16.11.2	Essential performance	341
16.12	Functional description of ventilator system	342
16.12.1	Gas supply and delivery.....	342
16.12.2	Gas monitoring with the flow sensor.....	343
16.12.3	Pneumatic diagram	345
16.13	Symbols used on device labels and packaging	346
16.13.1	Symbols used on the trolley.....	348

16.14 Standards and approvals	348
16.15 Disposal and year of manufacture	349
16.16 Warranty.....	350
Glossary	353
Index	361

HAMILTON-C6 Documentation

This guide is part of a documentation suite that includes, among others, the following documents:

Table 1. HAMILTON-C6 documentation suite

Document title	Description
<i>Operator's Manual (this guide)</i>	Provides detailed information about the setup and use of the HAMILTON-C6 ventilator.
<i>INTELLiVENT-ASV Operator's Manual</i>	Provides setup and use information for the INTELLiVENT-ASV ventilation mode.
<i>Pulse Oximetry Instructions for Use</i>	Provides setup and use information for using SpO2 and related sensors with the ventilator.
<i>Masimo Rainbow SET Instructions for use</i>	Provides setup and use information for using Masimo's rainbow SET SpO2 and related sensors with the ventilator.
<i>Volumetric Capnography User Guide</i>	Provides reference information for CO2 capnography.
<i>HAMILTON-H900 Instructions for Use</i>	Provides specifications, and setup and use information for the HAMILTON-H900 humidifier.
<i>IntelliCuff Instructions for Use</i>	Provides specifications, and setup and use information for the IntelliCuff cuff pressure controller.
<i>Aerogen Solo/Pro Instructions for Use</i>	Provides specifications, and setup and use information for the Aerogen Solo and Aerogen Pro nebulizers.
<i>P/V Tool Pro User Guide</i>	Provides information about assessing lung recruitability and performing recruitment maneuvers with the ventilator.
<i>Communication Interface User Guide</i>	Provides an overview of the communication interface, including how to connect the ventilator to external devices for data communication and support for nurse call remote alarms.
<i>Service Manual</i>	Provides information about installing and setting up the medical equipment, as well as additional technical and servicing information for the ventilator.
<i>EMC Declarations Guide</i>	Provides emissions and EMC-related safety and use information.
<i>HAMILTON-C6 Installation Guide</i>	Provides installation and setup information for the ventilator and the trolley.

Be sure to read the documentation before using the device or accessories.

To download the latest version of this manual or other documents, free of charge, visit the **MyHamilton** website.

To register, go to:

<https://www.hamilton-medical.com/MyHamilton>

Training



Hamilton Medical offers the Hamilton Medical College, which provides a variety of learning modules free of charge.

To register, go to:

<http://college.hamilton-medical.com>

Conventions used in this guide

In this manual:

- Button and tab names are shown in a **bold** font.
- The notation **XX > XX** shows the sequence of buttons/tabs to touch to open the associated window.
For example, the text "Touch **System > Settings**" means touch the **System** button, then touch the **Settings** tab.
- Window names are shown using the sequence of buttons/tabs used to open them.
For example, "Alarms > Limits 2 window" means the window is accessed by touching the **Alarms** button, then the **Limits 2** tab.
- *Software version*: The software version for the ventilator is displayed in the **System > Info** window and should match the version on the title page of this manual.
- A green check mark  or button  indicates a selected item or feature.

- The graphics shown in this manual may not exactly match what you see in your environment.
- The term *USB drive* refers to a passive USB memory device, also known as a USB flash drive or USB memory stick.
- Some figures use callouts in a white circle with a blue border.
 - ① These figures may have an associated legend table, or may provide the legend in the figures title, if a single item. Callouts may be numeric or alphabetic. Callouts are *unrelated* to any nearby procedures and refer only to the figures themselves and their associated legend.
- Some figures use small dark blue callouts.
 - ① These callouts show the sequence of steps. They are *not* directly related to the numbering in the text of any associated procedure.
- Not all features or products are available in all markets.
- Product description and order number may differ depending on region.
- *Units of measure*: Pressure is indicated in cmH₂O, length in cm, and temperature in degrees Celsius (°C). The units of measure for pressure and length are configurable.
- All patient-related pressure, volume, and flow measurements are expressed in BTPS (body temperature and pressure saturated).

- Pneumatic-related pressure, volume, and flow measurements are expressed in STPD (standard temperature and pressure dry).
- The graphics shown in this manual may display either of the product logos: HAMILTON-C6 or HAMILTON-C6S. The HAMILTON-C6S is not available in all markets.

Safety messages are displayed as follows:

WARNING

Alerts the user to the possibility of injury, death, or other serious adverse reactions associated with the use or misuse of the device.

CAUTION

Alerts the user to the possibility of a problem with the device associated with its use or misuse, such as device malfunction, device failure, damage to the device, or damage to other property.

NOTICE

Emphasizes information of particular importance.

In tables, safety messages are indicated as follows:

 **WARNING!**

 **CAUTION!**

 **NOTICE!**

Intended use

The HAMILTON-C6 ventilator is intended to provide positive pressure ventilatory support to adults and pediatrics, and optionally infants and neonates.

Intended areas of use:

- In the intensive care ward, intermediate care ward, emergency ward, long term acute care hospital, or in the recovery room
- During transfer of ventilated patients within the hospital

The HAMILTON-C6 ventilator is a medical device intended for use by qualified, trained personnel under the direction of a physician and within the limits of its stated technical specifications.

1

Safety information

1.1	Overview.....	22
1.2	Electromagnetic susceptibility.....	22
1.3	Fire and other hazards.....	23
1.4	General operation and setup.....	23
1.5	Setting up for ventilation.....	26
1.6	Ventilating the patient.....	31
1.7	Monitoring and alarms.....	33
1.8	Using the trolley.....	34
1.9	Maintenance.....	34
1.10	Service and testing.....	37

1.1 Overview

This chapter provides safety information related to setting up and operating the ventilator and trolley, as well as providing service.

Be sure to review this Operator's Manual before using the ventilator and any accessories.

Be sure to read the Instructions for Use provided with any devices and accessories used with the ventilator before use.

Carefully review all sections of this safety chapter before setting up the ventilator and accessories, and ventilating the patient.

If you have questions about any of the information in this manual, contact your Hamilton Medical representative or technical service personnel.

1.2 Electromagnetic susceptibility

WARNING

- **MR UNSAFE.** Keep away from magnetic resonance imaging (MRI) equipment. The ventilator poses unacceptable risks to the patient, medical staff, or other persons within the MR environment.
 - Correct function of the device may be impaired by the operation of high-frequency surgical equipment, microwaves, shortwaves, or strong magnetic fields in close proximity.
 - Follow precautions for electrostatic discharge (ESD) and electromagnetic interference (EMI) to and from the ventilator and any connected devices and accessories.
 - Use of accessories, transducers, and cables other than those specified by Hamilton Medical can result in increased electromagnetic emissions or decreased electromagnetic immunity of this equipment, and may result in improper operation.
 - Ensure a minimum of 15 cm (6 in) distance between the HAMILTON-C6 and any 134.2 kHz RFID equipment.
 - Portable RF communications equipment, including peripherals such as antenna cables and external antennas, should be placed no closer than 30 cm (12 in) to any part of the ventilator, including any specified cables. Otherwise, degradation of the performance of this equipment can occur.
 - Certain RF transmitting devices (cellular phones, RFID equipment, walkie-talkies, cordless phones, paging transmitters, etc.) emit radio frequencies that could affect ventilator performance if operated too closely to the ventilator. Be aware of possible radio frequency interference if portable devices are operated in close proximity to the ventilator.
 - The emissions characteristics of this equipment make it suitable for use in industrial areas and hospitals (CISPR 11, class A). If it is used in a residential environment (for which CISPR 11, class B is normally required) this equipment might not offer adequate protection to radio-frequency communication services. The user might need to take mitigation measures, such as relocating or reorienting the equipment.
-

The HAMILTON-C6 complies with the IEC 60601-1-2 EMC (Electromagnetic Compatibility) Collateral Standard.

The ventilator requires special precautions regarding electromagnetic compatibility (EMC). It must be installed and put into service according to the EMC information provided in the ventilator *EMC Declarations* (PN 624982).

When using the optional integration with the HAMILTON-H900 humidifier or Intelli-Cuff, refer to the respective *EMC Declarations* for the device (PN 624539 and 624750).

Portable and mobile RF communications equipment can affect the ventilator and all medical electrical equipment.

1.3 Fire and other hazards

WARNING

- It is *not* permitted to use any of the equipment with flammable gases or anesthetic agents, or in insufficiently ventilated areas. Danger of fire!
- It is *not* permitted to use the ventilator with helium or mixtures of helium.
- Do *not* use the ventilator with any equipment or high-pressure gas hoses that are worn or contaminated with oil or grease.
- Highly compressed oxygen together with flammable sources can lead to spontaneous explosions.
- In case of fire, immediately secure the patient's ventilatory needs, turn off the ventilator, and disconnect it from its gas and electrical sources.

- Do *not* use if primary power source cables are damaged.
- The HAMILTON-C6 can be used in an oxygen-enriched environment. To reduce the risk of fire, use only breathing circuits intended for use in oxygen-enriched environments. Do *not* use antistatic or electrically conductive tubing.

1.4 General operation and setup

This section provides the following safety information:

- General operation and setup
- Electrical: power and batteries
- Gas supply
- USB ports

1.4.1 General operation and setup

WARNING

- Modifications to the device and any accessories are *not* permitted.
- An O2 sensor *must* be installed.
- Do *not* connect nitric oxide or mixtures of nitric oxide to the Oxygen inlet; it is *not* permitted to use the ventilator with nitric oxide or mixtures of nitric oxide.
- In case of ventilator failure, the lack of immediate access to appropriate alternative means of ventilation can result in patient death.

- An alternative means of ventilation *must* be available whenever the ventilator is in use. If a fault is detected in the ventilator or its life-support functions are in doubt, disconnect the ventilator from the patient and *immediately* start ventilation with an alternate device (for example, a resuscitation bag), using PEEP and/or increased oxygen concentration when appropriate.

The ventilator *must* be removed from clinical use and serviced by a Hamilton Medical authorized service engineer.

- Use *only* parts and accessories specified in Chapter 15 and in the product e-catalog, or that are specified as being compatible with this ventilator. Doing so ensures proper ventilation operation, avoids degraded performance, and keeps your warranty in force.
- The use of this equipment is restricted to one patient at a time.
- Only use the ventilator and its components and accessories according to the intended use and as described in the associated *Instructions for Use*.
- Do *not* connect any component or device to the exhaust port of the expiratory valve unless authorized by Hamilton Medical.
- The ventilator must *not* be used in a hyperbaric chamber.
- If there is damage to any part of the ventilator, do *not* use the device. Technical service is required.
- Do *not* simultaneously touch conductive components (for example, the USB port) or conductive parts of the ventilator enclosure and the patient.

- Additional equipment connected to medical electrical equipment must comply with the respective IEC or ISO standards. All configurations must comply with the requirements for medical electrical systems, IEC 60601-1, clause 16.
- Anybody connecting additional equipment to medical electrical equipment configures a medical system and is responsible for ensuring that the system complies with the requirements for medical electrical systems. Local laws take priority over the above-specified requirements.

CAUTION

- Do *NOT* cover the ventilator or position it in such a way that the operation or performance of the ventilator is adversely affected.
- To prevent possible patient injury, do *NOT* block the holes at the back and bottom of the ventilator. These holes are vents for the fresh air intake and the cooling fan.

NOTICE

- Any incident with the device leading to serious patient injury, death, or a potential threat to public health must be reported to the manufacturer and the relevant authorities.
- The ventilator provides automatic barometric pressure compensation.
- Due to the ventilator's base flow, the exhaust gas output is larger than the patient's actual exhaled volume.

1.4.2 Electrical: power and batteries

WARNING

- Ventilation stops if the battery or batteries are discharged or removed and no external power supply is connected.
- To minimize the risk of electrical shock, plug the ventilator power cord into an appropriate grounded power receptacle. It is the hospital's responsibility to ensure that the receptacle is properly grounded (earth).
- Anybody connecting additional medical equipment to the power sockets on the ventilator configures a medical system and is responsible for ensuring that the system complies with the requirements for medical electrical systems.
- The HAMILTON-C6 requires protective earth grounding, because it is a class I device, as classified according to IEC 60601-1.
- Power sockets that can lead to a failure of ventilation *must* have a locking device.
- It is the responsibility of the operator to ensure that the power system of any device connected to the ventilator power outlet complies with the requirements for medical electrical systems as well as local regulations.
- Periodically check or replace the battery.
- Check the battery charge level before ventilating a patient and before unplugging the ventilator for transport or other purposes.
- The batteries will *not* charge if the ambient temperature is above 43°C.

CAUTION

To electrically isolate the ventilator electrical circuits from all poles of the primary power supply simultaneously, disconnect the power plug.

NOTICE

- Set up the ventilator in a location where the primary power supply is accessible.
- Only authorized service personnel may replace the power cable.
- Battery life indications are approximate. The actual battery life depends on ventilator settings, battery age, and level of battery charge. To ensure maximum battery life, maintain a full charge and minimize the number of complete discharges.
- After power has been interrupted, the device stores the last settings, including any specified alarm limits. Upon reconnection with the power supply, the device resumes ventilation with these stored settings.

1.4.3 Gas supply

CAUTION

Always check the status of the oxygen cylinders or other supply before using the ventilator during transport.

NOTICE

- To prevent damage to the ventilator, connect only clean, dry medical grade oxygen.
- When the ventilator is not in use, disconnect all gases.

1.4.4 USB ports

WARNING

- During transfer of a ventilated patient, to prevent water intake, the ventilator USB port *must* be covered.
- Do *not* use the USB port to make a wireless connection of any kind.

NOTICE

- Before using the USB port, touch the ventilator to discharge any static electricity.
- You can only connect one item to the USB port at a time.
- The USB drive must be USB 1.1 compatible.
- If you remove the USB drive before files are completely transferred, you *must* turn the ventilator off and on again to reset the USB port.
- Only the following components are allowed to be connected to the USB port:
 - USB passive memory drive (referred to as a *USB drive*)
 - Hamilton Medical-approved accessories; see your authorized representative

1.5 Setting up for ventilation

This section provides safety information for the following:

- Patient breathing circuits, components, and accessories
- Performing preoperational checks and testing
- Humidifier
- IntelliCuff
- CO2 monitoring setup and operation
- Nebulization
- SpO2 monitoring setup and operation
See the *Pulse Oximetry Instructions for use*.

1.5.1 Patient breathing circuits, components, and accessories

In addition to the information provided in this section, carefully review the information in Sections 1.3 and 1.4.

WARNING

- **To prevent patient or ventilator contamination, always use a bacteria filter or HMEF between the patient and the inspiratory port. If no bacteria filter is used, the exhaled gas can contaminate the ventilator.**
- Ensure that all of the components of the breathing circuit set, including but not limited to flow sensor, humidifier, and other accessories, match the associated intended use for the target patient group.

- Adding attachments or other components/assemblies to a breathing system can change the pressure gradient across the ventilator, which can adversely affect ventilator performance.
- Make sure a HEPA filter is installed by the air intake. See Section 13.4.1.
- For each new patient, *always* use a new or reprocessed breathing circuit to avoid cross contamination.
- During ventilation, regularly check the breathing circuit filter for increased resistance and blockage.

NOTICE

- Any bacteria filter, HMEF, or additional accessories in the expiratory limb may substantially increase flow resistance and impair ventilation.
- When adding components to the Hamilton Medical breathing circuit configurations, do *not* exceed the inspiratory and expiratory resistance values of the ventilator breathing system as specified in Section 16.10, as required by ISO 80601-2-12.
- Pressure and volume measurement accuracy may be affected by using a breathing circuit with high resistance. Accuracy was tested with Hamilton Medical devices using the breathing circuits PN 260039 for adults, PN 260189 for pediatrics, and PN 151969 for neonates.

1.5.2 Preoperational check and tests

CAUTION

- *To prevent possible patient injury, disconnect the patient from the ventilator before running the preoperational tests, and use another source of ventilatory support.*
- *To ensure the ventilator's safe operation, always run the preoperational check before using the ventilator on a patient.*
- *Do NOT use the ventilator until necessary repairs are completed and all preoperational tests have passed.*

NOTICE

- To ensure that all breathing circuit connections are leak-tight, perform the **Leak** test every time you connect a circuit or change a circuit part.
- If there is a mismatch between the selected patient group and the type of flow sensor connected, the calibration fails. Ensure you are using the correct flow sensor for the patient.

1.5.3 Humidifier

WARNING

- Before using a humidifier, review the *Instructions for Use* as well as the *Instructions for Use* provided with its accessories.
- To prevent possible patient injury and equipment damage, do *not* turn the humidifier on until the gas flow has started and is regulated. Turn the humidifier off before stopping gas flow.

- Adding attachments or other components/assemblies to a connected humidifier can change the pressure gradient across the ventilator, which can adversely affect ventilator performance.
- Regularly check the water traps and the breathing circuit limbs for water accumulation. Empty as required.

CAUTION

When using active humidification, prevent water accumulation in the flow sensor by ensuring that the flow sensor is positioned at a $\geq 45^\circ$ angle relative to the floor. Excess water can affect the flow sensor measurements and lead to inaccurate volume delivery, potentially resulting in hypoventilation.

Figure 1-1. Position flow sensor at an angle $\geq 45^\circ$ angle relative to the floor

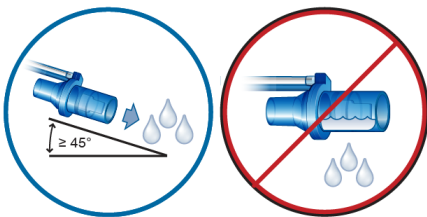

NOTICE

The humidifier is not powered by the ventilator when operating on the backup battery.

1.5.4 IntelliCuff

WARNING

- Never connect the tubing to any other device or connector other than to the IntelliCuff port on the ventilator and to the inflating tube on the tracheal tube or tracheostomy tube.
- Disconnect the IntelliCuff tubing from the tracheal or tracheostomy tube when IntelliCuff is turned off.

CAUTION

- Use only Hamilton Medical disposable tubing with a filter and safety valve. Use of any other tubing will result in the immediate loss of cuff pressure if disconnected at the ventilator. Use of any other tubing without a filter may result in the device being contaminated.
- Check tubing regularly. Bent or kinked tubes can provide incorrect monitoring information.

1.5.5 CO2 sensor setup and operation

WARNING

- Monitor the CO2 waveform (capnogram) on the ventilator display. If it appears abnormal, check the patient, settings, and the breathing circuit components, including the CO2 sensor sampling line. Adjust and replace components as appropriate.
- If the capnogram appears abnormal, inspect the CO2 airway adapter and replace if needed.
- Elevated baseline can be caused by sensor problems or by the patient's condition.

- Do *not* use any CO2 sensor/adaptor if it appears to be damaged or if it fails to operate properly. Refer servicing to Hamilton Medical authorized personnel.
- Do *not* use the CO2 components when they are wet or have exterior condensation.
- In NIV and neonatal ventilation with uncuffed tubes, leaks may influence the capnogram and the measured values.
- Always connect all components securely and check for leaks according to standard clinical procedures.
- Positioning of tubes and cables:
 - Do *not* position the cables or tubing in any manner that may cause patient entanglement or strangulation.
 - Support the tubing to avoid stress on the ET tube.
 - Do *not* apply excessive tension to any cable or tubing.
- During use, a system leak, such as that caused by an uncuffed ET tube or damaged airway adapter, may significantly affect sensor readings, including flow, volume, pressure, and other respiratory parameters.
- Leakages in the breathing or sampling system may cause the displayed CO2 values to be significantly under-reported (too low).
- Keep all cleaning agents away from the CO2 sensor electrical connections.
- For the CO2 sensor/adaptor, use only cleaning and disinfection agents that are recommended in Table 13-4.
- Periodically check the sensor and tubing for excessive moisture or secretion build-up, and replace if needed. Excessive moisture can affect measurements.
- **LoFlo sidestream CO2 sensor.** Do *not* use with patients who cannot tolerate the removal of 50 ml \pm 10 ml/min from their total minute volume. In adaptive modes (such as ASV, APVcmv, and APVsimv), the removal is fully compensated.
- **LoFlo sidestream CO2 sensor.** Use of devices containing PVC plasticized with DEHP should be limited to the amount of time treatment is medically necessary, especially for neonates and pregnant or nursing mothers.

CAUTION

- *All devices are NOT protected against reanimation with a defibrillator. Disconnect the CO2 sensor before using a defibrillator on the patient.*
- *Always use the correct CO2 airway adapter for the patient group. In adult patients, smaller geometrics increase airway resistance and induce low tidal volumes and intrinsic PEEP. In neonatal patients, larger geometrics impede effective CO2 removal and add dead space.*
- *Do NOT place the CO2 sensor directly on the patient's skin. It can burn the skin as the sensor may reach a temperature of 46°C (115°F).*
- *Use during nebulization may influence the CO2 measurements. In addition, the medication can contaminate the sensor windows, causing the sensor to fail prematurely.*
- **LoFlo sidestream CO2 sensor.** *Remove the sampling kit sample cell from the module when not in use.*
- **LoFlo sidestream CO2 sensor.** *Do NOT stick finger into the sample cell receptacle.*

NOTICE

- Position airway adapters with windows in a vertical, *not* a horizontal, position. This helps keep patient secretions from pooling on the windows. If pooling occurs, remove the adapter, rinse with water, and reconnect.
- Do *not* combine the neonatal CO₂ airway adapter and the adult flow sensor. Doing so can increase resistance, create artifact, or lead to hypoventilation, intrinsic PEEP, or overinflation.
- Do *not* place the CO₂ sensor/adapter between the ET tube and the elbow, as this may allow patient secretions to enter the tubing and block the adapter windows.
- The CO₂ sensors and accessories that have contact with the patient are not made with natural rubber latex.
- Nitrous oxide, elevated levels of oxygen, helium, and halogenated hydrocarbons can influence the CO₂ measurement.

1.5.6 Nebulization

For additional safety information related to Aerogen nebulizers, see the *Aerogen Solo/Pro Instructions for Use*.

WARNING

- Nebulization of drugs can cause an occlusion and increased resistance of a connected expiratory filter or heat and moisture exchanger (HMEF). Check the filter frequently for increased resistance or blockage.

- Connect the nebulizer in the inspiratory limb per your institution's policy and procedures. Connecting the nebulizer between the flow sensor and the endotracheal tube increases dead space and causes incorrect volume measurements.
- Pneumatic nebulization affects the delivered oxygen concentration.
- Nebulization can affect the accuracy of CO₂ measurements.
- The use of a pneumatic nebulizer adds gas to the ventilator breathing system, which can affect the accuracy of volume or flow measurements.

CAUTION

To prevent the expiratory valve from sticking due to nebulized medications, regularly check and clean or replace the expiratory valve membrane and/or the expiratory filter.

NOTICE

- Pneumatic nebulization is disabled:
 - During neonatal ventilation (if needed, use an Aerogen nebulizer¹)
 - When using HiFlowO₂ therapy
- Only use approved piezo nebulizers with the HAMILTON-C6.

¹ Not available in all markets.

1.6 Ventilating the patient

This section provides the following safety information:

- Specifying patient settings
- Neonatal ventilation
- Apnea backup
- TRC settings
- P/V Tool Pro
- Noninvasive ventilation
- Using high flow oxygen therapy

1.6.1 Specifying patient settings

WARNING

- It is the clinician's responsibility to ensure that all ventilator settings are appropriate, even when "automatic" features, such as ASV, or default settings are used.
- To prevent possible patient injury:
 - Make sure the ventilator is set up for the appropriate patient group with the appropriate breathing circuit components.
 - For each patient group, make sure you select the correct patient sex and height (**Adult/Ped**) or weight (**Neonatal**). Correct entries help prevent hyper- or hypo-ventilation.
- The ventilator is a high-flow device that can operate with flows above 80 l/min and with a high oxygen concentration.

1.6.2 Neonatal ventilation

In addition to the information provided in this section, carefully review the information in Sections 1.5 and 1.6.

WARNING

Prolonged exposure to high oxygen concentrations may cause irreversible blindness and pulmonary fibrosis in pre-term neonates. Be especially careful when performing oxygen enrichment.

CAUTION

- To prevent increased CO₂, do NOT use an adult airway adapter for neonates as it will increase dead space.
- To determine appropriate tidal and minute volumes for neonatal patients, you must consider (anatomic) dead space. Artificial airways (for example, Y-piece, flow sensor, ET tube, CO₂ airway adapter) increase the dead space.
- When using active humidification, prevent water accumulation in the flow sensor by ensuring that the flow sensor is positioned at a $\geq 45^\circ$ angle relative to the floor. Excess water can affect the flow sensor measurements and lead to inaccurate volume delivery, potentially resulting in hypoventilation.

Figure 1-2. Position flow sensor at a $\geq 45^\circ$ angle relative to the floor

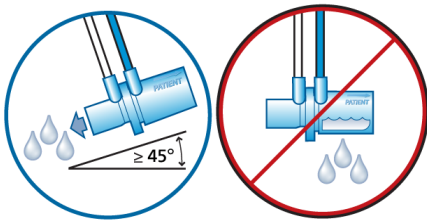

NOTICE

When switching between the **Adult/Ped** and the **Neonatal** patient groups, you must calibrate the flow sensor and perform the **Leak** test.

1.6.3 Apnea backup

CAUTION

We recommend you enable **Apnea backup** ventilation whenever a mode that allows spontaneous breathing is selected. **Apnea backup** is enabled by default.

1.6.4 TRC settings

WARNING

To ensure patient safety, check that the **Pressure** alarm limit is set appropriately when using TRC, as real pressure may be higher than the set pressure.

CAUTION

To prevent patient injury, be especially careful when defining TRC settings, as using the incorrect tube type or size setting can endanger the patient.

1.6.5 PV Tool Pro

WARNING

Do not attempt to use the PV Tool on an active patient as it can cause patient discomfort and erroneous readings.

NOTICE

- During a maneuver and for 30 seconds following the end of the maneuver, all patient alarms are paused.
- Apnea time begins after the end of the maneuver.

- Use of the P/V Tool provides information that, in conjunction with hemodynamic data and other clinical information, may be used to optimize PEEP and other ventilator settings.
- During the maneuver, the high Pressure alarm is automatically set to Ptop + 5 cmH2O.
When the maneuver is finished, the high Pressure alarm limit returns to the previous setting.
If IntelliCuff is connected, Pcuff may also be affected. For details, see Section 12.2.4.2.
- A calibrated flow sensor and a tight circuit produce the best results.

1.6.6 Noninvasive ventilation

NOTICE

- As a precaution, while noninvasive ventilation is in use, you must be prepared to intubate the patient and start invasive ventilation at any time.
- The use of a mask can increase dead space. Always comply with the mask manufacturer's instructions when using noninvasive ventilation.
- The Inspiratory volume limitation alarm is inactive in noninvasive modes.

1.6.7 Using high flow oxygen therapy

WARNING

- Use only interfaces intended for high flow oxygen therapy that allow the patient to exhale, such as a nonocclusive high-flow nasal cannula, tracheal adapter, or tracheal mask. This is

important because exhalation through the expiratory valve is not possible when using high flow oxygen therapy.

- Ensure the ventilator's gas pipeline system does not exceed the pipeline design flow capacity. If the system exceeds the flow capacity, it can interfere with the operation of other equipment using the same gas source.
- Always use active humidification during high flow oxygen therapy.

CAUTION

To reach a high oxygen concentration in a short period of time, flows higher than 4 l/min are required at the beginning of the therapy.

1.7 Monitoring and alarms

CAUTION

- *To prevent possible patient injury, make sure the alarm limits are appropriately set before you place the patient on the ventilator.*
- *The HAMILTON-C6 oxygen monitoring function can be disabled. Ensure that an alternative means of oxygen monitoring is always available and enabled.*
- *To ensure that oxygen monitoring is always fully functional, replace an exhausted or missing O2 sensor as soon as possible or use an external monitor that complies with ISO 80601-2-55.*

NOTICE

- The HAMILTON-C6 is *not* intended to be a comprehensive vital sign monitor for patients on life-support equipment. Patients on life-support equipment should be appropriately monitored by qualified medical personnel and suitable monitoring devices.
- Do *not* pause the audible alarm when leaving the patient unattended.
- The factory default alarm limit settings are set in line with the selected patient group, allowing for unattended monitoring. These settings, however, can *never* replace individual review of the patient and adjustment of alarm limits based on their condition.
- The use of an alarm monitoring system does *not* give absolute assurance of warning for every type of issue that may arise with the ventilator. Alarm messages may *not* pinpoint a problem exactly; the exercise of clinical judgment is necessary.
- It is recommended that additional independent monitoring devices, including pulse oximeters measuring SpO₂, be used during mechanical ventilation. The operator of the ventilator must still maintain full responsibility for proper ventilation and patient safety in all situations.

- Alarm conditions, including technical faults/events, that are *not* directly related to a physiological sensor (CO₂, SpO₂) do *not* affect the function of any attached physiological sensor, including the values of any associated CO₂, SpO₂, and pulse-rate measurements. Real-time waveforms on the ventilator provide a method for assessing the displayed numeric values.
- The alarm limits **Auto** function is *not* available during neonatal ventilation.

1.8 Using the trolley

WARNING

- To prevent possible personal injury and equipment damage, including tipping:
 - Lock the trolley's wheels when parking the ventilator.
 - Take care when crossing thresholds.
- To prevent accidental extubation, check the patient tubing support arm joints and secure as necessary.

1.9 Maintenance

This section provides the following safety information:

- Maintenance, cleaning, and disinfection
- Preventive maintenance
- O₂ sensor

1.9.1 General maintenance, cleaning, and disinfection

WARNING

- Reprocessing of Hamilton Medical single-use products can affect the product properties and may cause injury to the patient. For example, a change to the surface structure during reprocessing may lead to a change in the tear strength or cause actual cracking. Furthermore, an altered surface structure may result in a microbial aggregation of spores, allergens, and pyrogens, for example, or cause an increase in the number of particles released as a result of chemical changes in the material properties.
- To reduce the risk of cross-contamination, regularly clean and replace the fan filter. For details, see Table 13-5 and Section 13.4.1.
- To prevent patient exposure to sterilizing agents and to prevent premature deterioration of parts, sterilize parts using only the techniques recommended in Chapter 13 and in any associated *Reprocessing Guide* or *Instructions for Use* provided with each part.
- Hamilton Medical does *not* assume any liability for the proper functioning of single-use items if they are reprocessed and reused by the user.
- Always use caution when handling bacteria filters to minimize the risk of bacterial contamination or physical damage. Dispose of used filters immediately after use. Follow your hospital procedures for disposal.

- Follow the cleaning, disinfection, and sterilization procedures for each component as described in this guide and in the cleaning agent manufacturer's *Instructions for Use*.
- Always disconnect the device and any accessories, including CO2 sensor/adaptor, from electrical power before cleaning and disinfection to reduce the risk of electric shock.

CAUTION

- Do *NOT* sterilize or immerse the CO2 sensor in liquids.
- Do *NOT* attempt to sterilize the interior components of the ventilator.
- Do *NOT* attempt to sterilize the entire device with ETO gas.
- Incorrect concentrations or residence times of sterilization agents may lead to bacterial resistance.
- To prevent premature deterioration of parts, make sure the disinfecting chemical is compatible with the part material. Use only registered/ approved cleaning and disinfection solutions, as approved by your institution's protocol, after each patient use, according to the cleaning agent manufacturer's recommendations.
- Intrusion of fluids, or immersing parts in fluids, will damage the device.
- Do *NOT* pour fluids onto the device surfaces.
- Do *NOT* use abrasives materials (for example, steel wool or silver polish), hard brushes, pointed instruments, or rough materials on surfaces.

- *Thoroughly rinse all patient- or airway-contact components to ensure removal of residual cleaning/disinfection agents.*
 - *Cleaning and disinfection agent residues can cause blemishes or fine cracks, especially on parts exposed to elevated temperatures during sterilization.*
-

NOTICE

For specific information on cleaning, disinfecting, and sterilizing autoclavable (reusable) accessories and components, refer to the appropriate *Reprocessing Guide* and *Instructions for Use* provided with each part.

1.9.2 Preventive maintenance

NOTICE

- Dispose of all parts removed from the device according to your institution's protocols. Comply with all local, state, and federal regulations with respect to environmental protection, especially when disposing of the electronic device or parts of it (for example, O2 sensor).
 - We recommend that you document all maintenance procedures.
 - It is *not* allowed to perform service or maintenance on the device while a patient is connected.
 - If no bacteria (inspiratory) filter is used, the device *must* be considered contaminated and *must* be serviced.
-

1.9.3 O2 sensor

NOTICE

- Replace the O2 sensor with a genuine Hamilton Medical O2 sensor only; otherwise, oxygen measurement will *not* function and permanent oxygen-related alarms may be generated.
 - To prevent leakage within the ventilator, make sure an O2 sensor is installed at all times, even if you use an external monitor or disable oxygen monitoring.
 - Keep the oxygen sampling site free of other gases to avoid affecting oxygen sampling.
 - The paramagnetic O2 sensor must only be replaced if it fails. In this case, have the ventilator serviced.
-

1.10 Service and testing

- To ensure proper servicing and to prevent possible physical injury, *only* Hamilton Medical authorized service personnel may service the ventilator using information provided in the ventilator *Service Manual*.
In addition, all accessories and devices must only be serviced by Hamilton Medical authorized service personnel.
- The manufacturer can *only* be responsible for the safety, reliability, and performance of the ventilator if *all* of the following requirements are met:
 - Appropriately trained personnel carry out assembly operations, extensions, readjustments, modifications, maintenance, or repairs.
 - The electrical installation of the relevant room complies with the appropriate requirements.
 - The ventilator system is used in accordance with the ventilator *Operator's Manual*.
 - Do *not* attempt service procedures other than those specified in the ventilator *Service Manual*.
- Any attempt to modify the ventilator hardware or software without the express written approval of Hamilton Medical automatically voids all warranties and liabilities.

2

System overview

2.1	Overview.....	40
2.2	Physical descriptions.....	43
2.3	Navigating the windows and controls.....	57

2.1 Overview

The HAMILTON-C6 ventilator system comprises the following main components:

- Detachable monitor with integrated alarm lamp and touch screen display
- Ventilation unit for gas mixing and control, and patient breathing circuit for gas delivery and exchange
- Oxygen monitoring using a galvanic or optional paramagnetic sensor
- Optional connections to a humidifier, nebulizer, IntelliCuff cuff pressure controller, SpO2 and CO2 sensors, and external data interfaces
- Trolley or shelf mount

The ventilator system offers the following main features:

- *Monitoring:* Real-time waveforms, numerical monitoring, trends, loops, and Intelligent panels showing the patient's real-time breathing status, ventilator dependence, and targets, CO2 and SpO2 measurements (when enabled)
- Alarms and on-screen troubleshooting help
- Configurable startup settings for each patient group
- Remote access to the HAMILTON-H900 humidifier controls and status
- Monitoring and control of the IntelliCuff cuff pressure controller from the ventilator
- Transpulmonary pressure measurement
- Support for pneumatic or Aerogen nebulization

2.1.1 Standard features and options

The ventilator offers a robust set of standard equipment and features, as well as optional modes and features for the supported patient groups.

Table 2-1 lists the standard software configuration and options.

Table 2-2 lists the standard equipment (hardware) and options.

Table 2-1. Standard software configuration and options

Function	Patient group	
	Adult/Ped	Neonatal
	Standard: X Option: O Not applicable: --	
Patient groups	X	O
Modes		
Intelligent ventilation modes		
ASV®	X	--
INTELLiVENT®-ASV® ⚠ WARNING! Not available in the USA.	O	--
Volume-controlled, flow-controlled modes		
(S)CMV	X	--
SIMV	X	--
Volume-targeted, pressure-controlled modes		
APVcmv / (S)CMV+	X	X
APVsimv / SIMV+	X	X
Pressure-controlled modes		
DuoPAP, APRV	X	X
PCV+	X	X
PSIMV+	X	X
SPONT	X	X
Noninvasive modes		
HiFlowO2	O	O
NIV, NIV-ST	X	X
nCPAP-PS	--	O
Other functions		
P/V Tool® Pro	O	O
Transpulmonary pressure monitoring	X	X
Flow and pressure triggers	X	X

Function	Patient group	
	Adult/Ped	Neonatal
IntelliSync®+	O	--
TRC	X	X
Suctioning tool	X	X
Trends/Loops	X	X
On-screen help	X	X

Table 2-2. Standard equipment (hardware) configuration and options

Functions	HAMILTON-C6
Standard: X Option: O Not applicable: --	
Trolley or shelf mount solution (selected when ordering)	X
Trolley accessories: Oxygen cylinder holder (2 bottles), HAMILTON-H900 mounting system	O
Second battery	O
Communication board: CO2/SpO2 or CO2/SpO2/Aerogen nebulizer	O
Extended communication ports: Three COM ports, two USB ports, DVI, Nurse call	X
Communication protocols: GALILEO compatible, Hamilton P2, Hamilton Block, Hamilton Block (ACK), Philips VueLink Open, DrägerTestProtocol, HAMILTON-H900	X
Lead-free O2 sensor	X
Paramagnetic O2 sensor	O
HAMILTON-H900 humidifier integration ²	X
IntelliCuff® cuff pressure controller integration	O

² Activated upon connection of a HAMILTON-H900 humidifier.

2.2 Physical descriptions

This section provides an overview of the ventilator, breathing circuit sets, and trolley.

Figure 2-1. HAMILTON-C6 with accessories

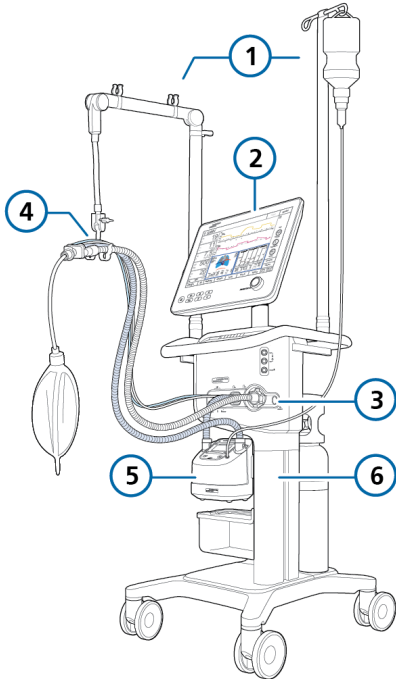

- | | |
|---------------------------------|---------------------|
| 1 Support arm and infusion arm | 4 Breathing circuit |
| 2 Display and controls | 5 Humidifier |
| 3 Breathing circuit connections | 6 Trolley |

2.2.1 About the ventilator



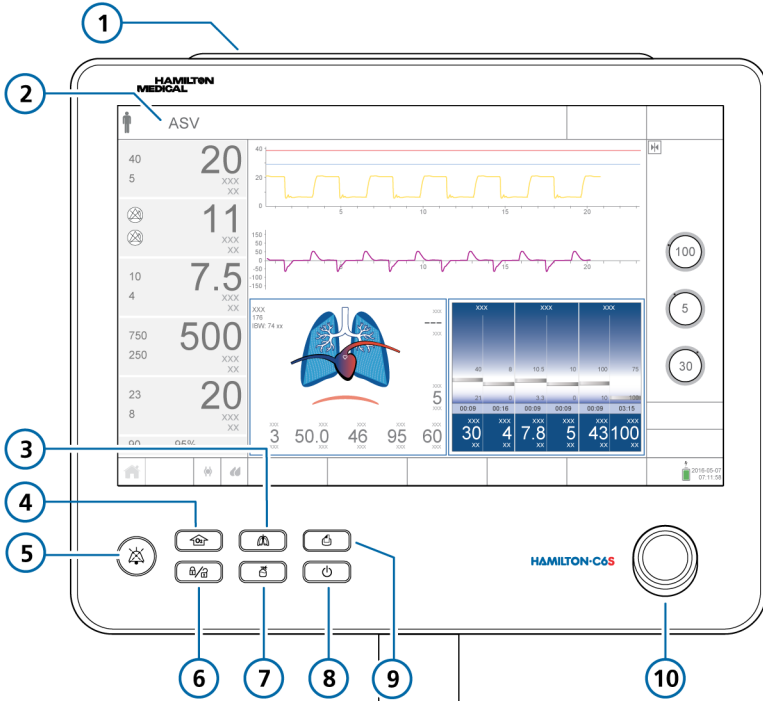



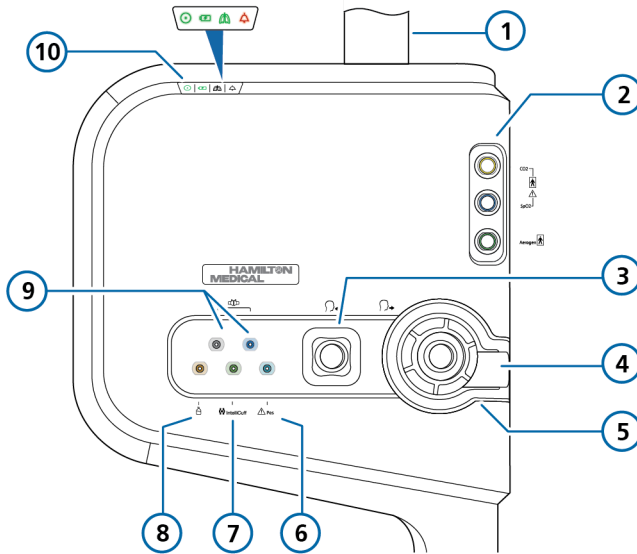

Figure 2-2. Front view, ventilator monitor



- | | | | |
|---|-----------------------------------|----|---------------------------|
| 1 | Alarm lamp | 6 | Screen lock/unlock |
| 2 | Touch screen display (Figure 2-6) | 7 | Nebulizer key |
| 3 | Manual breath key | 8 | Power/Standby key |
| 4 | O2 enrichment key | 9 | Print screen key |
| 5 | Audio pause key | 10 | Press-and-Turn (P&T) knob |

Figure 2-3. Front view, ventilator body



1		Monitor post	6		Pes port
2		Communication board* with CO2, SpO2, Aerogen ports (optional)**	7		IntelliCuff port
3		To patient inspiratory port	8		Pneumatic nebulizer port
4		From patient expiratory port	9		Flow sensor connection ports
5		Expiratory valve set	10		Status indicator panel (Section 2.2.1.1)

* When the board is not installed, this area is covered by a plate.

**Note that the SpO2, CO2, and Aerogen labels on the ventilator body are always present, regardless of whether the communication board is installed or a given connection port on the board is active.

Figure 2-4. Rear view, ventilator body

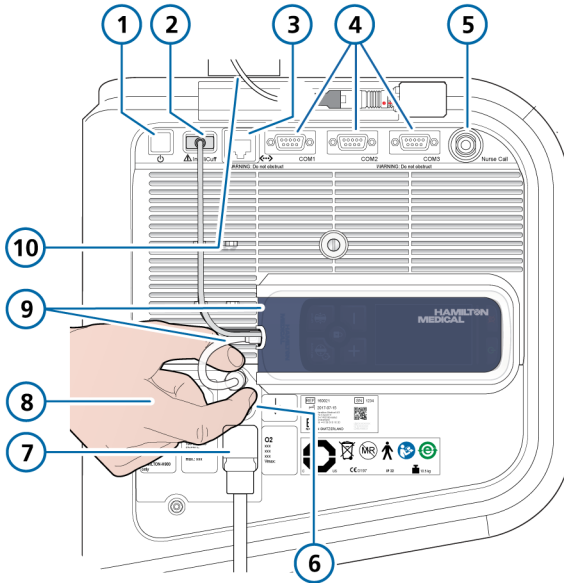

- | | | | |
|---|---------------------------------|----|--|
| 1 | Power/Standby button | 6 | Potential equalization conductor |
| 2 | IntelliCuff USB port* | 7 | High-pressure oxygen DISS or NIST inlet fitting |
| 3 | LAN port (internal use only) | 8 | Power sockets: one for HAMILTON-H900 humidifier <i>only</i> (left), AC power (right) |
| 4 | RS-232 COM1, COM2, COM3** ports | 9 | IntelliCuff housing and connection cables (shown connected) |
| 5 | Nurse call port | 10 | Monitor cable |

* Used for the built-in IntelliCuff connection (shown connected)

** Only for HAMILTON-H900 connection

Figure 2-5. Rear view, ventilator monitor

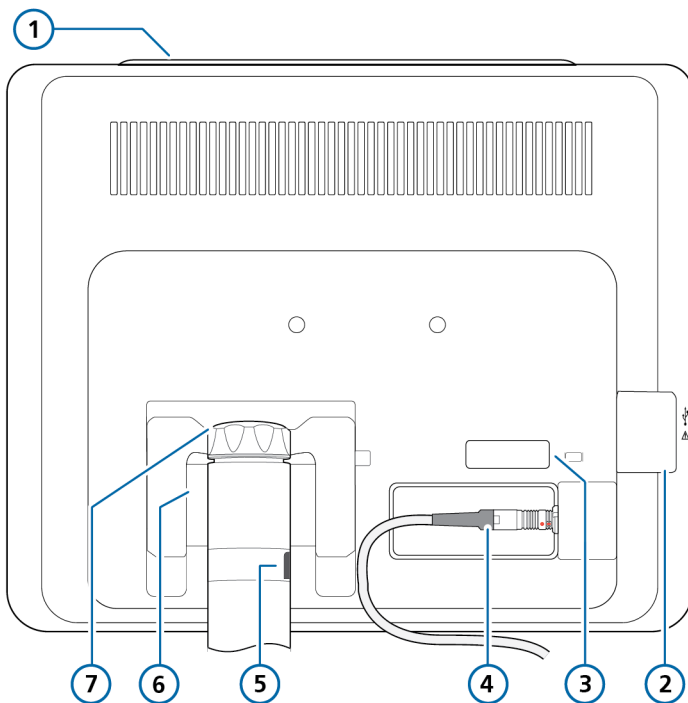



- | | | | |
|---|---|---|--|
| 1 | Alarm lamp | 5 | Mounting post with lock/release button |
| 2 | USB port | 6 | Tilt and swivel mount |
| 3 | DVI port | 7 | Tilt and swivel mount locking cap |
| 4 | Monitor connection port and cable to ventilator | | |



2.2.1.1 About the status indicators on the ventilator

Indicator lights on the front of the ventilator unit show important ventilation and device status information.

If communication between the ventilator monitor (referred to as the *interaction panel* in alarm messages) and the ventilator unit is disrupted, the status indicators on the front of the ventilator body display critical ventilation information, including alarm status.

Table 2-3. Status indicators

Symbol	Description
	Power indicator. Solid green when the ventilator is turned on.
	Battery status indicator. <i>Solid green:</i> Lit to show that the battery is fully charged and the device is connected to primary power, even when the ventilator is turned off. <i>Flashing green:</i> Flashes to show that the device is connected to a primary power source and the battery is charging, even when the ventilator is turned off. <i>Not lit:</i> Dark to show the battery is not charging (the device is running on battery power and is not connected to a primary power source or the battery is overheated).

Symbol	Description
	Active ventilation indicator. Light pulses green with each inspiratory breath. For details, see Section 7.7.
	Alarm indicator. Flashes red when an alarm is generated. For alarm-related information, see Chapter 9.

2.2.2 About the main display

Figure 2-6. Main display

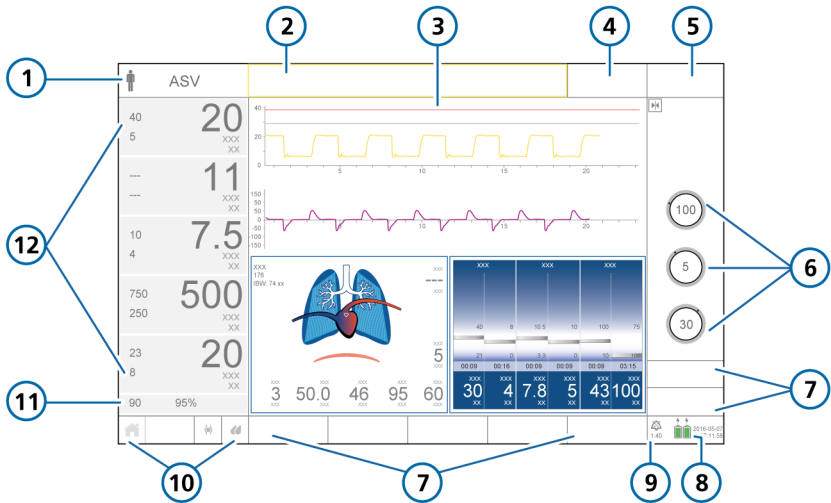

- | | | | |
|---|--|----|---|
| 1 | Patient group symbol and active mode | 7 | Window buttons: Alarms, Controls, Monitoring, Graphics, Tools, Events, System |
| 2 | Message bar (color coded) | 8 | Power source and date/time |
| 3 | Configurable graphic display (full-length waveforms shown) | 9 | Audio pause indicator and countdown timer |
| 4 | Target button, available in INTELLiVENT-ASV | 10 | Quick access buttons |
| 5 | Modes button | 11 | SpO2 low alarm limit and current value* |
| 6 | Main controls for the active mode | 12 | Main monitoring parameters (MMP) |

* When SpO2 monitoring is enabled.

2.2.3 About the patient breathing circuits

Figure 2-7. Adult/pediatric breathing circuits

Adult/Ped: Dual limb with humidifier

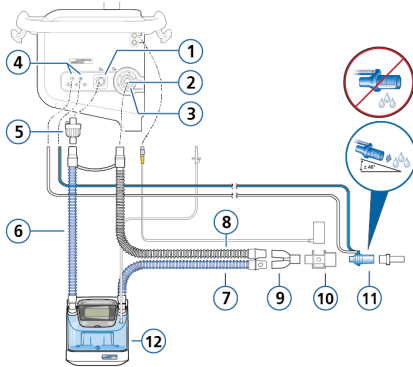

Adult/Ped: Coaxial with HMEF

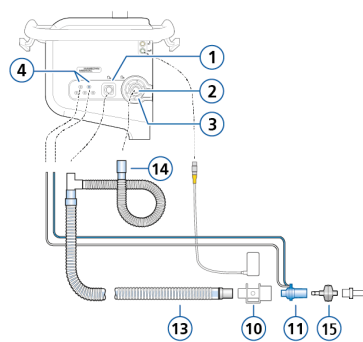

- | | | | |
|---|---|----|-------------------------------------|
| 1 | To patient inspiratory port | 9 | Y-piece |
| 2 | From patient expiratory port | 10 | CO2 sensor/adaptor |
| 3 | Expiratory valve set | 11 | Flow sensor |
| 4 | Flow sensor connection ports | 12 | Humidifier |
| 5 | Bacteria filter | 13 | Coaxial inspiratory/expiratory limb |
| 6 | Inspiratory limb to humidifier | 14 | Expiratory limb extension |
| 7 | Heated inspiratory limb with temperature sensor, to patient | 15 | HMEF |
| 8 | Heated expiratory limb | | |

Some connection adapters may be required, but are not shown. Refer to the breathing circuit Instructions for use.

Figure 2-8. Adult/pediatric breathing circuits: high flow oxygen therapy

Adult/Ped: Dual limb, high flow oxygen therapy

Adult/Ped: Single limb, high flow oxygen therapy

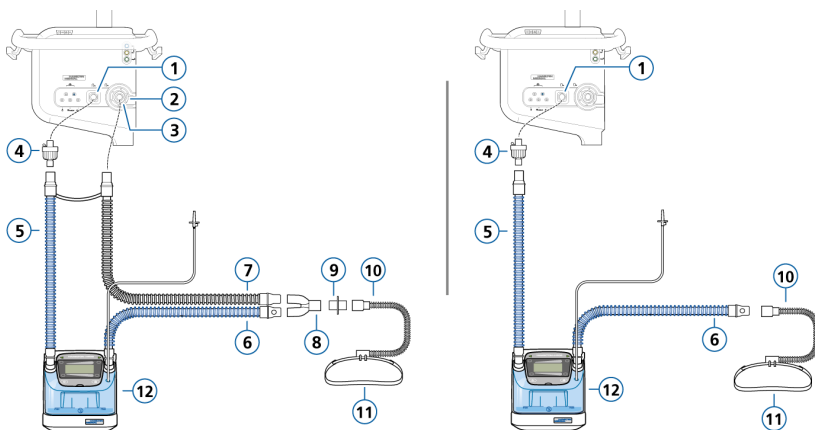

- | | | | |
|---|---|----|------------------------|
| 1 | To patient inspiratory port | 7 | Heated expiratory limb |
| 2 | From patient expiratory port | 8 | Y-piece |
| 3 | Expiratory valve set | 9 | Adapters (various) |
| 4 | Bacteria filter | 10 | Nasal cannula |
| 5 | Inspiratory limb to humidifier | 11 | Attachment strap |
| 6 | Heated inspiratory limb with temperature sensor, to patient | 12 | Humidifier |

Figure 2-9. Neonatal breathing circuits

Neonatal/pediatric: Dual limb with humidifier

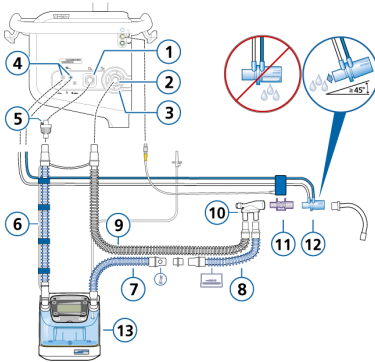

Neonatal/pediatric: Dual limb with HMEF

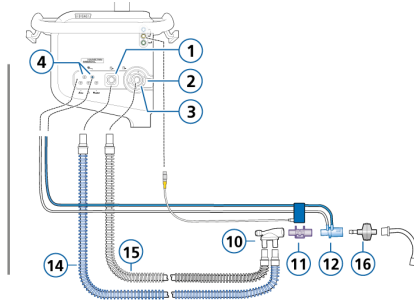

- | | | | |
|---|---|----|------------------------|
| 1 | To patient inspiratory port | 9 | Heated expiratory limb |
| 2 | From patient expiratory port | 10 | Y-piece |
| 3 | Expiratory valve set | 11 | CO2 sensor/adaptor |
| 4 | Flow sensor connection ports | 12 | Flow sensor |
| 5 | Bacteria filter | 13 | Humidifier |
| 6 | Inspiratory limb to humidifier | 14 | Inspiratory limb |
| 7 | Heated inspiratory limb with temperature sensor, to patient | 15 | Expiratory limb |
| 8 | Unheated inspiratory limb extension, for use in incubator | 16 | HMEF |

Some connection adapters may be required, but are not shown. Refer to the breathing circuit Instructions for use.

Figure 2-10. Neonatal breathing circuits: high flow oxygen therapy

Neonatal/pediatric: Dual limb, high flow oxygen therapy

Neonatal/pediatric: Single limb, high flow oxygen therapy

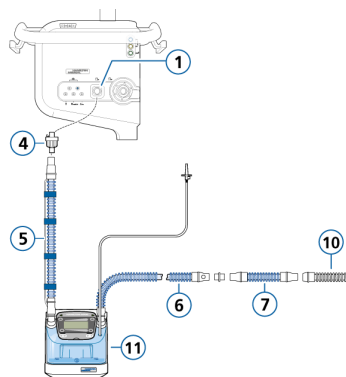
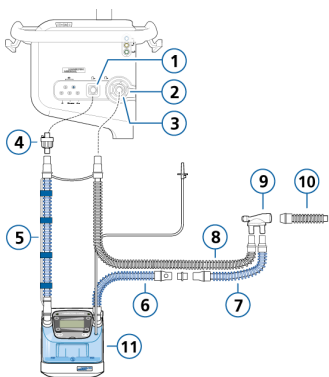

- | | |
|---|---|
| <ul style="list-style-type: none"> 1 To patient inspiratory port 2 From patient expiratory port 3 Expiratory valve set 4 Bacteria filter 5 Inspiratory limb to humidifier 6 Heated inspiratory limb with temperature sensor, to patient | <ul style="list-style-type: none"> 7 Unheated inspiratory limb extension, for use in incubator 8 Heated expiratory limb 9 Y-piece 10 Connection to patient interface (options not shown) 11 Humidifier |
|---|---|

Some connection adapters may be required, but are not shown. Refer to the breathing circuit Instructions for use.

Figure 2-11. Neonatal breathing circuit: nCPAP-PS

Neonatal: nCPAP-PS

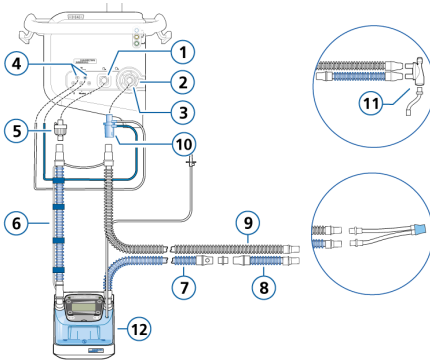

1	To patient inspiratory port	7	Heated inspiratory limb with temperature sensor, to patient
2	From patient expiratory port	8	Unheated inspiratory limb extension, for use in incubator
3	Expiratory valve set	9	Heated expiratory limb
4	Flow sensor connection ports	10	Flow sensor (connected to expiratory port)
5	Bacteria filter	11	Y-piece
6	Inspiratory limb to humidifier	12	Humidifier

2.2.4 About the trolley and mounting variations

The HAMILTON-C6 can optionally be ordered with a trolley or a shelf mount solution. The trolley has space for one oxygen cylinder.

2.2.4.1 Preparing the trolley for intra-hospital transport

Before proceeding, review the safety information in Chapter 1.

WARNING

- Only the components listed in this section are approved for intrahospital transport.
- Use of additional items, such as a tubing support arm, can result in the trolley tipping over.

CAUTION

To prevent possible equipment damage, avoid overloading the HAMILTON-C6's basket and tray, or placing objects on the HAMILTON-C6 that might compromise its stability.

If using a HAMILTON-C6 trolley, the ventilator and its components, as well as the trolley, **must be** configured and positioned as follows during transport within the hospital:

- The oxygen cylinders must be securely attached to the trolley.

- Only the following components are allowed to be connected during transport:
 - Breathing circuit
 - Tubing support arm
 - Flow sensor
 - CO2 sensor (mainstream or side-stream)
 - O2 cylinder
 - SpO2 sensor, including Masimo adapter
 - Aerogen nebulizer
 - IntelliCuff
 - Humidifier
 - Water bottle
 - Water bottle holder
 - Basket

2.2.5 Adjusting the monitor

You can adjust the monitor's position and set it to the desired orientation and angle by turning and tilting it, as needed.

An adjustment cap allows you to adjust the force required to turn the monitor from side to side. Two screws allow you to adjust the force required to change the tilt angle of the monitor.

Turning the monitor side to side

1. Turn cap counter-clockwise to loosen, if needed.
2. Turn monitor to desired position.

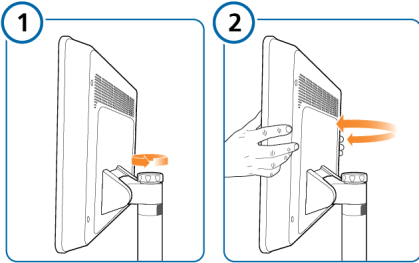

Tilting the monitor up and down

1. Unscrew locking screws to loosen, if needed.
2. Tilt monitor to desired angle between -165° and $+165^{\circ}$.

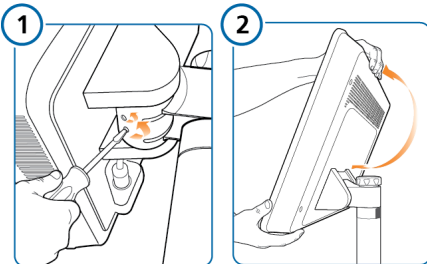

2.2.6 Connecting a remote monitor to the DVI port

Before proceeding, review the safety information in Chapter 1.

NOTICE

- A second display is not intended to replace the real-time display of data on the device. DO NOT USE the second monitor to supplement or replace any part of the hospital's device monitoring.
- Therapy device settings that are displayed on the second monitor are read-only.

They can *only* be changed directly on the device itself.

The HAMILTON-C6 comes with an additional video output port (DVI) that allows you to attach a second monitor for remote viewing. See Figure 2-5.

Remote monitoring can be useful when a patient's condition requires special access precautions, for example, due to COVID-19 or other illness.

Remote monitoring requires a compatible DVI cable and a monitor with a resolution of 1920 x 1200 @60 Hz. Ensure that the DVI cable and second monitor comply with your institution's electronics standards.

We recommend using a fiber-optic DVI cable when using a second monitor. Be sure to follow the cable manufacturer's instructions for use.

To connect a second monitor

1. Unscrew the plate covering the DVI port.
2. Connect the DVI cable to the DVI port on the ventilator.
3. Connect the DVI cable to the second monitor.
4. Turn on the second monitor.

To disconnect a second monitor

1. Turn off the second monitor.
2. Disconnect the DVI cable from the second monitor.
3. Disconnect the DVI cable from the ventilator.
4. Re-install the plate over the DVI port.

2.3 Navigating the windows and controls

Use the touch screen and the Press-and-turn knob (referred to as the *P&T knob*) to access data and specify settings.

You interact with the HAMILTON-C6 user interface as follows:

- Touch elements on the display to open windows and make and confirm selections, as well as specify settings by using the control slider, when available.
- Use the **P&T** knob to select, specify, and confirm selections. A selected item is highlighted in yellow.
- If using INTELLiVENT-ASV, you can:
 - Swipe left/right on the panels that are displayed during active ventilation (horizons, maps, plethysmogram/capnogram, SBT history) to cycle through the panel options.
 - Swipe within the SBT history panel to cycle through previous SBT data.
 - Swipe within the **Oxygenation** map panel to switch between the PEEP/SpO₂ and FiO₂/PEEP maps.
 - In the INTELLiVENT-ASV Settings window, swipe left/right on the left-hand map panel to switch between the **Oxygenation** and the **Ventilation** maps.

This section describes how to navigate the interface.

2.3.1 Accessing windows

To open a window

- ▶ Do any of the following to open a window:
 - Touch the button and any needed tabs.
 - Turn the **P&T** knob to move the cursor to the button or tab, then press the **P&T** knob.

To close a window

- ▶ Do any of the following to close a window:
 - Touch the window button again.
 - Touch the **X** button.
 - Turn the **P&T** knob to move the cursor to the **X** button, then press the **P&T** knob.

2.3.2 Adjusting controls

Specifying settings involves *activating* a control, *setting* a value, and *confirming* the setting.

The HAMILTON-C6 offers multiple ways to adjust control settings:

- Activate the control and use the **P&T** knob to set and confirm the value.
- Activate the control and use the control slider (when available) to set the value.

To adjust a control setting

1. **Activate** the control by doing any of the following:
 - Touch the control to select and activate it; the selected control is highlighted in yellow.

– Turn the **P&T** knob to move the cursor to the control, then press the **P&T** knob to activate it.

The activated control is orange (Figure 2-12).

2. **Adjust** the value by doing any of the following:

– If displayed, touch the slider (Figure 2-13) and drag it to the desired value. The value is also shown on the associated control.

– Tap the **+** or **-** buttons in the slider area to incrementally increase/decrease the value.

– Turn the **P&T** knob to increase or decrease the value.

3. **Confirm** the setting by doing any of the following:

- Touch the control again.
- Press the **P&T** knob.

The new setting is immediately applied and the slider bar (if open) is automatically closed.

You can manually close the slider bar at any time by touching the **X** button. Any changes you made are discarded.

Figure 2-12. Control status: activated

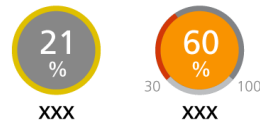
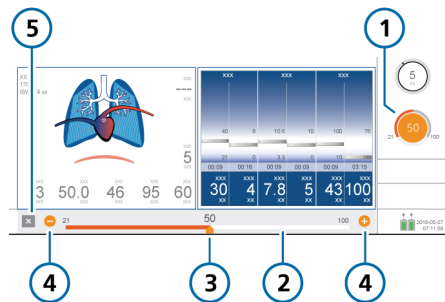

Figure 2-13. Control slider



- | | |
|--------------------------------|---|
| 1 Activated control and value | 4 +/- : incrementally increase/decrease the value |
| 2 Control slider bar | 5 X (close) button |
| 3 Slider showing current value | |

2.3.3 Selecting list items

Some selections are presented in a scrollable list.



To select a list item





1. In a list, touch the scroll bar to select and activate it.
2. Turn the P&T knob to scroll through the list, and when the desired selection is highlighted, press the knob to select it.

2.3.4 Using shortcuts

The ventilator provides shortcuts for some key functions.

Table 2-4. Shortcuts

Touch Quick access icon/ shortcut on main display ...	To display the ...
	Controls > Patient window
Mode name	Modes window
Any MMP	Alarms > Limits 1 window
SpO2 value ³ (under MMPs)	Alarms > Limits 2 window
Any graphic (waveform, Intelligent panel, loop, trend)	Graphics selection window
 (any displayed Battery icon)	System > Info 1 window

Touch Quick access icon/ shortcut on main display ...	To display the ...
2017-08-07 07:11:58	System > Settings > Date & Time window
 or  1:40	Alarms > Buffer window
Alarm message in the Alarms > Buffer window	On-screen alarm troubleshooting help
	Default layout specified for the selected Quick setup
	System > IntelliCuff window ⁴
	System > Humidifier window ⁴

³ When SpO2 sensor enabled.

⁴ If enabled.

3

Preparing the ventilator

3.1	Overview.....	62
3.2	Connecting to a power source	62
3.3	Connecting the oxygen supply	63
3.4	Setting up the patient breathing circuit	64
3.5	Setting up esophageal/transpulmonary pressure monitoring.....	68
3.6	Turning the ventilator on and off	69

3.1 Overview

Preparing the ventilator for use comprises the following steps:

To ...	See ...
Connect to a power source.	Section 3.2
Connect the oxygen supply.	Section 3.3
Set up the patient breathing circuit, including performing the preoperational check.	Section 3.4
Connect external devices and sensors.	Chapter 4
Turn on the ventilator.	Section 3.6
Select the patient group, mode, and alarm limits, and enter patient data.	Chapter 5

3.2 Connecting to a power source

Before proceeding, review the safety information in Chapter 1.

Always check the reliability of the primary power outlet before plugging in the ventilator. The charge icon above the battery shows that the ventilator is plugged in and the batteries are charging.

To connect the ventilator to a primary power supply

1. Connect the ventilator to an outlet that supplies AC power.

Make sure the power cord is well seated into the ventilator socket and secured with the power cord retaining clip to prevent unintentional disconnection.

2. Connect one end of a grounding cable to the equipotential grounding conductor on the ventilator (Figure 2-4) and the other to a properly grounded outlet.

3.2.1 Using battery power

A mandatory backup battery protects the ventilator from low power or failure of the primary power source.

When the primary power source fails, the ventilator automatically switches to operation on backup battery with no interruption in ventilation. An alarm sounds to signal the switch-over. Silence the alarm to confirm notification of the power system change and reset the alarm.

If battery power is completely lost, a buzzer sounds continuously for at least two minutes.

Batteries are charged whenever the ventilator is connected to the primary power supply, whether or not it is turned on. The battery status indicator on the front of the ventilator body (Section 2.2.1.1) shows the charge status of the battery.







During active ventilation when the ventilator is running on battery power, the time remaining on the current battery charge is displayed in the **System > Info 1** window in the **Battery rem. time** field. If the display shows dashes (--), the remaining time is being recalculated.

An optional second battery is available. It is shown on the display when installed.

Figure 3-1. Power source indicators on display



Table 3-1. Battery/power state

Power icon on display	Battery/power state
	Device is plugged into primary power and the battery is charging.
	Device is running on battery power.
	Battery is fully charged.
	Battery is partially charged.
	Battery has less than 10% charge left.
	The primary battery is either defective or not installed.
Battery status indicator	See Section 2.2.1.1.

If a battery is not fully charged, recharge it by connecting the ventilator to the primary power source. For details, see Section 16.4.

Chapter 13 describes how to replace the battery.

3.3 Connecting the oxygen supply

Before proceeding, review the safety information in Chapter 1.

High-pressure oxygen, provided by a central gas supply or a gas cylinder, is supplied through DISS or NIST male gas fittings. With the optional cylinder holder, you can mount oxygen cylinders to the trolley. If you use gases from cylinders, secure the cylinders to the trolley with the accompanying straps.

To connect the oxygen supply to the ventilator

- ▶ Connect the oxygen hose to the ventilator's oxygen inlet fitting (Figure 2-4).

3.4 Setting up the patient breathing circuit

Before proceeding, review the safety information in Chapter 1.

Connecting the breathing circuit comprises the following steps.

For neonatal ventilation, see Chapter 6.

To ...	See ...
Install the expiratory valve.	Section 3.4.2
Select the appropriate breathing circuit and components.	Section 3.4.3
Assemble the breathing circuit.	Section 3.4.4
Adjust the position of the breathing circuit.	Section 3.4.5
Change breathing circuit components during ventilation	Section 3.4.6
Connect external devices and sensors.	Chapter 4
Perform any required tests, calibrations, and the preoperational check.	Chapter 5

3.4.1 Breathing circuit connections on the ventilator

Figure 3-2 illustrates the key ports on the ventilator for connecting the breathing circuit set.

For breathing circuit diagrams, see Section 2.2.3.

Figure 3-2. Key connection ports, front of ventilator

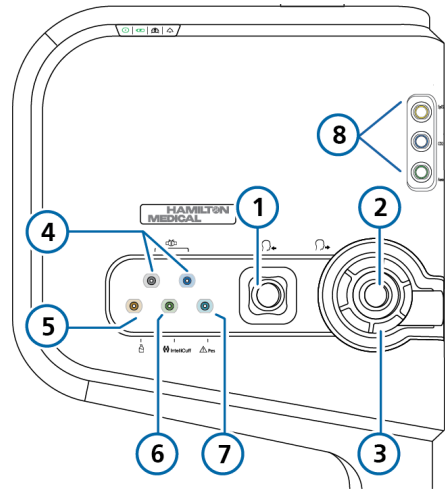

- | | |
|--------------------------------|---|
| 1 To patient inspiratory port | 5 Nebulizer port |
| 2 From patient expiratory port | 6 IntelliCuff tubing port |
| 3 Expiratory valve set | 7 Pes port |
| 4 Flow sensor connection ports | 8 Communication board with CO ₂ , SpO ₂ , Aerogen ports, if installed |

3.4.2 Working with the expiratory valve set

This section describes how to assemble/install, and remove/disassemble the expiratory valve set.

To assemble/install the expiratory valve set

Refer to Figure 3-3.

1. Remove the safety cover.
2. Ensure the membrane is properly aligned with the expiratory valve housing and the metal plate faces up (A).
3. Position the expiratory valve set in the expiratory port (B) and twist the locking ring clockwise until it locks into place (C).

Figure 3-3. Installing the expiratory valve set

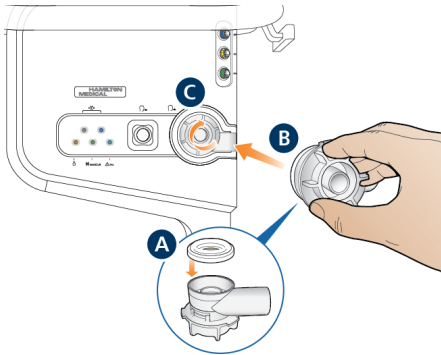

To remove and disassemble the expiratory valve set

1. Remove the expiratory valve set from the expiratory port on the ventilator.
2. Holding the expiratory valve housing, remove the silicone membrane (A in Figure 3-3) by lifting it up.

3.4.3 Selecting the breathing circuit components

Select the correct breathing circuit parts for your patient.

For neonatal ventilation, see Chapter 6.

Table 3-2. Breathing circuit component specifications

Patient data/ Component	Adult	Pediatric
Patient height (cm)	> 130	30 to 150
IBW (kg)	> 30	3 to 48
Breathing circuit limb ID (mm) ⁵	15 to 22	10 to 22
Flow sensor	Adult/Ped	Adult/Ped
CO ₂ airway adapter	Adult/Ped ⁶	Adult/Ped ⁶

⁵ When using coaxial breathing sets, follow the manufacturer's recommendations for each patient group.

⁶ When tracheal tube ID > 4 mm.

3.4.3.1 Using a filter in the breathing circuit

NOTICE

When connecting a filter to the inspiratory or expiratory port, pay special attention to the fit and seal of the filter to the port, in particular with filters that offer additional connectors (such as a luer connector).

For proper function, it is important that all components in the breathing circuit set are properly positioned and securely connected.

Before proceeding, review the safety information in Chapter 1.

Inspiratory bacteria filter

To prevent patient or ventilator contamination, be sure to connect a bacteria (inspiratory) filter or HMEF between the patient and the inspiratory port.

For neonatal patients, use a neonatal-pediatric HMEF.

If no inspiratory filter is used, the exhaled gas can contaminate the ventilator. If you are not using an inspiratory filter, and an exhalation obstructed alarm is generated, the ventilator may be contaminated. Have the ventilator serviced.

Expiratory bacteria filter

Before using an expiratory filter with nebulization, review the safety information in Section 1.5.6.

An expiratory filter is not technically required on the HAMILTON-C6. The expiratory valve design prevents internal ventilator components from coming into contact with the patient's exhaled gas, preventing any cross-contamination. However, your institution's protocol for certain circumstances may require the use of an expiratory filter (COVID-19 or other illness/disease, no room contamination, and so on).

If you use an expiratory filter, place it on the patient side of the expiratory valve set. Monitor closely for increased expiratory circuit resistance.

An Exhalation obstructed alarm may also indicate excessive expiratory circuit resistance. If the Exhalation obstructed alarm occurs repeatedly, remove the expiratory filter immediately. If you otherwise suspect increased expiratory circuit resistance, remove the expiratory filter or replace the filter to eliminate it as a potential cause.

Heat and moisture exchanging filter (HMEF)

The HMEF is a passive humidification component used together with a bacteria filter. Use an HMEF when ventilating with a coaxial breathing system.

3.4.4 Assembling the patient breathing circuit

Assemble the appropriate breathing circuit for your patient. Commonly used standard breathing circuit configurations are illustrated in Section 2.2.3.

For neonatal ventilation, see Chapter 6.

3.4.4.1 Connecting the flow sensor

NOTICE

To prevent inaccurate flow sensor readings, make sure the flow sensor is correctly connected.

Before proceeding, review the safety information in Chapter 1.

To connect a flow sensor to the breathing circuit

1. Insert a flow sensor into the breathing circuit in front of the patient connection (Figure 3-4).

See also the breathing circuit diagrams in Section 2.2.3.

2. Attach the blue and clear tubes to the flow sensor connection ports on the ventilator (Figure 3-2).

The blue tube attaches to the blue connection port. The clear tube attaches to the silver connection port.

3. Calibrate the flow sensor and perform the Leak test. See Section 5.4.

Figure 3-4. Connecting the flow sensor to the Y-piece or circuit

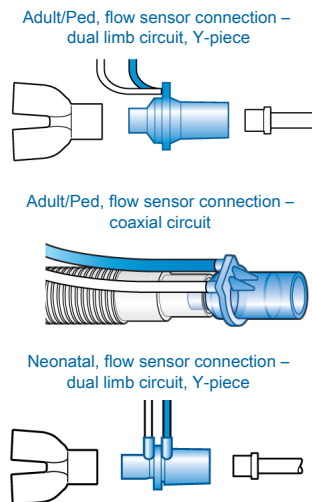

3.4.4.2 Use of adult/pediatric flow sensor with neonatal/pediatric breathing circuits

NOTICE

Only use a neonatal/pediatric breathing circuit with an adult/pediatric flow sensor when the patient IBW is 20 kg or below.

With small pediatric patients whose IBW is below 20 kg, using an adult/pediatric breathing circuit can generate too much dead space, resulting in ineffective ventilation.

For these patients, consider using a neonatal/pediatric breathing circuit with an adult/pediatric flow sensor instead.

To use an adult/pediatric flow sensor with a neonatal/pediatric breathing circuit

1. Verify that the **Adult/Ped** patient group is selected.
2. Verify that the patient **IBW** is below 20 kg.
3. Set up the ventilator for adult/pediatric ventilation with the adult/pediatric flow sensor, but connect a neonatal/pediatric breathing circuit.
4. Perform the **Leak** test, calibrate the flow sensor, and perform other preoperational checks. See Section 5.4.
5. Connect the patient.
6. Start ventilation.

3.4.5 Positioning the breathing circuit

NOTICE

- To prevent water accumulation in the flow sensor and tubing, position the flow sensor tubing on top of the flow sensor.
- Ensure there is no undue stress placed on any tubing or cables.

After assembly, position the breathing circuit so that the hoses will *not* be pushed, pulled, or kinked as a result of a patient's movement, transport, or other activities, including scanner bed operation and nebulization.

The next step is to perform all required tests, calibrations, and the preoperational check. See Chapter 5.

3.4.6 Changing breathing circuit components during ventilation

During ventilation, it may be necessary to add components to the breathing circuit, or to change existing components. To do so in the safest manner for the patient and personnel, we recommend following this general process:

1. Enter **Standby**.
2. Provide alternative ventilation for the patient.
3. Change or add components, in accordance with your institution's standards and protocols.
4. Perform the preoperational check (Section 5.4).
5. Re-connect the patient.
6. Verify settings, and resume ventilation.

3.5 Setting up esophageal/transpulmonary pressure monitoring

The **Pes** port allows you to use pressure readings other than airway pressure (**Paw**), for example, from an esophageal balloon catheter, for monitoring purposes. Transpulmonary pressure is also calculated using a combination of the **Paw** and **Pes** pressures.

To display **Pes**-related parameters

- ▶ Connect an esophageal catheter to the **Pes** port on the front of the ventilator (Figure 2-3).

The associated pressure-related parameters are available in the **Monitoring > Pes** window. For details, see Section 8.5.

3.6 Turning the ventilator on and off

To ensure the Event log records all events properly, do the following:

- When entering **Standby**, wait at least 30 seconds before turning off the ventilator.
- After turning off the ventilator, wait at least 3 seconds before turning the ventilator back on.

To turn on the ventilator

- ▶ Press  (Power/Standby) on the front of the monitor.

The ventilator runs a self-test. After a short time, the **Standby** window is displayed.

Proceed with setting up the ventilator and patient, as appropriate.

Figure 3-5. Power/Standby key (1)

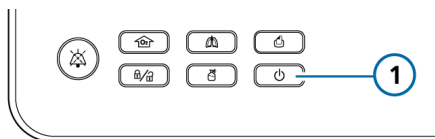

To turn off the ventilator

NOTICE

If using IntelliCuff, you must first deflate the cuff and turn off the device before turning off the ventilator.

1. Press  (Power/Standby) on the front of the monitor to open the **Activate Standby** window during active ventilation.
2. Touch **Activate standby** to confirm.
The ventilator enters **Standby**.

3. Press and hold  for about 3 seconds to turn off the ventilator.
The ventilator turns off.

In the event of a technical fault or the device will not turn off

- ▶ Press and hold  for about 10 seconds to turn off the ventilator.

4

Setting up external devices and sensors

4.1	Overview.....	72
4.2	Setting up a humidifier.....	72
4.3	Setting up the IntelliCuff cuff pressure controller.....	73
4.4	Setting up CO2 monitoring.....	74
4.5	Setting up SpO2 monitoring.....	77
4.6	Enabling sensors.....	78
4.7	Setting up nebulization.....	78
4.8	Connecting to external devices.....	80

4.1 Overview

The HAMILTON-C6 supports a variety of external devices and sensors for ventilation, including:

- Humidifier
- IntelliCuff cuff pressure controller
- CO2 monitoring sensors
- Pulse oximetry (SpO2 monitoring) sensors
- Nebulizers

This chapter describes how to set them up for ventilation.

4.2 Setting up a humidifier

Before proceeding, review the safety information in Chapter 1.

When used with the optional HAMILTON-H900 humidifier, the ventilator supports remote access to the humidifier controls and status.^{7,8}

Other humidifiers are supported, without the integration. To connect a non-Hamilton Medical humidifier, refer to the manufacturer's *Instructions for use*.

To connect the HAMILTON-H900 humidifier to the ventilator

1. Attach the humidifier to the trolley, if appropriate.
2. Connect the HAMILTON-H900 humidifier power cable to the dedicated power socket on the ventilator (Figure 2-4).

3. Connect a potential equalization cable to the humidifier and to a grounding socket at your facility.
4. Connect the communication cable to the humidifier (Figure 4-1) and to the configured COM port on the ventilator (Figure 4-2).
COM3 is configured for the HAMILTON-H900.

Figure 4-1. Connect communication cable to the humidifier

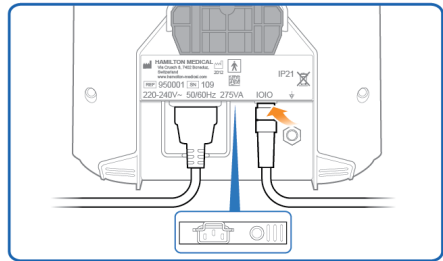
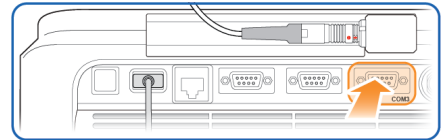

Figure 4-2. Connect HAMILTON-H900 to the ventilator



If data export is configured, humidifier data is also transmitted from the ventilator to an external monitoring system.

For additional details about:

- Connecting the humidifier to the breathing circuit, see Section 2.2.3.
- Working with the humidifier, see the *HAMILTON-H900 Instructions for use*.
- Controlling the humidifier from the ventilator, see Chapter 12.

⁷ Not available in all markets.

⁸ Supported for HAMILTON-H900 software version 1.05b and later.

4.3 Setting up the IntelliCuff cuff pressure controller

The ventilator supports the use of an optional IntelliCuff cuff pressure controller, and offers integrated operation and monitoring of the device. IntelliCuff integration is not available with a stand-alone device.

For details on using IntelliCuff during ventilation, see Section 12.2.

IntelliCuff is installed into a compartment in the rear of the ventilator, and all controls and operations are managed from the ventilator display.

The USB communication/power cable and cuff tubing set are integrated with the ventilator, and are already connected to the appropriate ports. You connect the cuff tubing from the patient to the dedicated **IntelliCuff** port on the front of the ventilator.

For setup details, see Section 4.3.2.

4.3.1 About the IntelliCuff tubing

The IntelliCuff connector allows connection only from the ventilator end (with the shut-off valve) of the Hamilton Medical cuff pressure tubing.

The ventilator end of the tubing has a built-in shut-off valve, which prevents loss of cuff pressure in the event of a disconnection from the ventilator. The patient end of the tubing fits the connector (pilot balloon) for cuff pressure measurement on the ET tube or the tracheostomy cannula.

4.3.2 Setting up IntelliCuff

If not already installed, contact your technical service representative to configure IntelliCuff default settings and install IntelliCuff into the ventilator compartment.

Once installed, the device is always available.

For each patient, you connect the cuff and tubing to the patient tubing and to the ventilator, and specify the desired settings.

To connect the cuff tubing

1. Connect the cuff tubing to the patient tubing as described in the *IntelliCuff Instructions for use*.
2. Connect the other end of the cuff tubing to the **IntelliCuff** port on the front of the ventilator (Figure 4-3).

Figure 4-3. Connect IntelliCuff tubing to IntelliCuff port on ventilator (1)

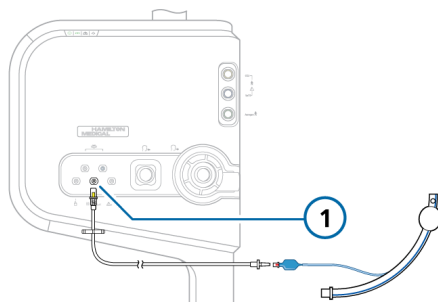

For operation details, see Section 12.2 and the *IntelliCuff Instructions for use*.

4.4 Setting up CO2 monitoring

Before proceeding, review the safety information in Chapter 1.

CO2 monitoring data is helpful for the assessment of the patient's airway integrity or ensuring proper endotracheal tube placement, among other applications.

Two CO2 measurement options are available: mainstream and sidestream. Which option you use depends on the clinical setting.⁹

Enabling CO2 measurement on the ventilator requires enabling the CO2 hardware (in Configuration) and enabling the sensor.

Table 4-1. CO2 measurement overview

For details about ...	See ...
Mainstream CO2 measurement, connection, and use	Section 4.4.1
Sidestream CO2 measurement, connection, and use	Section 4.4.2
Enabling the CO2 hardware	Section 14.10.2
Enabling the CO2 sensor	Section 4.6

4.4.1 Mainstream CO2 measurement

The CO2 monitoring option comprises the following components (shown in Figure 4-4): communication board, airway adapter, and CO2 sensor.

The sensor generates infrared light and beams it through the airway adapter to a detector on the opposite side. CO2 from the patient, flowing through the main-stream airway adapter, absorbs some of this infrared energy.

The system determines the CO2 concentration in the breathing gases by measuring the amount of light absorbed.

The ventilator displays CO2 measurements as numeric values, waveforms, trends, and loops.

Figure 4-4. Mainstream CO2 monitoring components and assembly

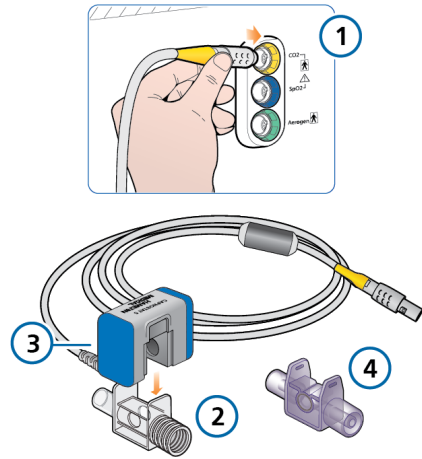

- | | |
|--|-----------------------------|
| 1 Communication board with CO2 connection port | 3 CO2 sensor |
| 2 Airway adapter (Adult/Ped.) | 4 Airway adapter (Neonatal) |

⁹ The volumetric capnogram is only available when using a mainstream CO2 sensor.

4.4.1.1 Connecting the mainstream CO2 sensor

Before proceeding, review the safety information in Chapter 1.

CAUTION

When using active humidification, prevent water accumulation in the CO2 adapter by ensuring that it is positioned at a $\geq 45^\circ$ angle relative to the floor. Excess water can affect the sensor measurements.

NOTICE

You must use an appropriate adapter to connect the mainstream CO2 sensor to a neonatal flow sensor.

Ensure the CO2 sensor and adapter are clean and dry before connection.

To set up mainstream CO2 monitoring

Refer to Figure 4-4.

1. Connect the sensor cable to the CO2 connection port (1) on the ventilator.
2. Attach the CO2 sensor (3) to the airway adapter (2), aligning the arrows on both components.
Press the components together until they click.
3. When connecting a CO2 sensor for the first time, perform the zero calibration of the sensor/adapter, if needed, as described in Section 5.4.5.
4. Connect the sensor/adapter to the breathing circuit proximal to the patient, in a vertical position. See Figure 4-5. (The figure shows a subset of the breathing circuit setup.)

Do *not* place the airway adapter between the ET tube and the elbow, as this may allow patient secretions to accumulate in the adapter.¹⁰

The sensor cable should face away from the patient.

5. Secure the cable safely out of the way.

Figure 4-5. Connecting CO2 sensor/adapter (1) to breathing circuit

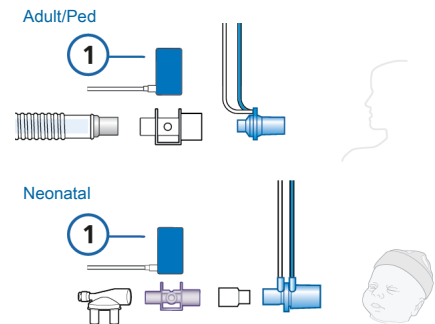

To verify the quality of the connection

- ▶ Check the capnogram (CO2 waveform) on the ventilator display.
If CO2 levels are higher than expected, check the patient condition. If you determine that the patient's condition is not contributing, calibrate the sensor (Section 5.4.5).

To disconnect the sensor cable from the ventilator

- ▶ Pull back on the connector sheath and disengage from the connection port on the ventilator.

¹⁰ You can connect the CO2 sensor in front of or behind the flow sensor according to your institution's protocol.

4.4.2 Sidestream CO2 measurement

The LoFlo CO2 module is a sidestream CO2 monitoring system comprising the following components (shown in Figure 4-6): communication board, airway sampling adapter, and CO2 module.

The module generates infrared light and beams it through the sample cell to a detector on the opposite side. CO2 from the patient that is aspirated into the sample cell absorbs some of this energy. The system uses a sampling rate of 50 ml/min.

The system determines CO2 concentration in the breathing gases by measuring the amount of light absorbed.

The ventilator displays CO2 measurements as numeric values, waveforms, trends, and loops.

Figure 4-6. Sidestream CO2 monitoring components and assembly

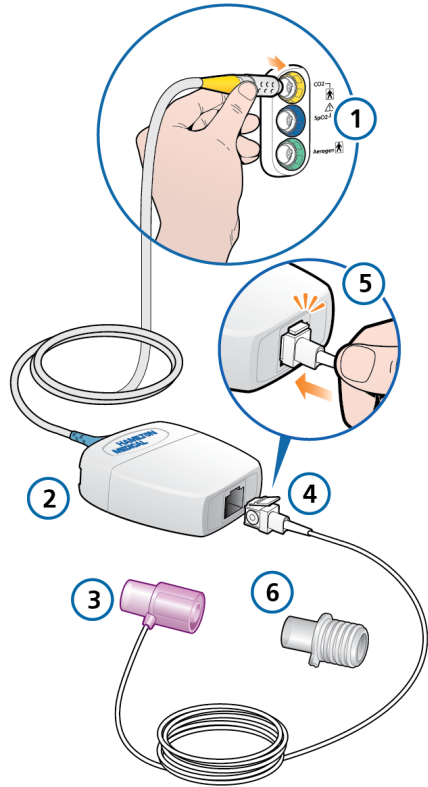

- | | | | |
|---|--|---|------------------------------------|
| 1 | Communication board with CO2 connection port | 4 | Sampling cell |
| 2 | CO2 module | 5 | Connecting sampling cell to module |
| 3 | Airway adapter (Neonatal) | 6 | Airway adapter (Adult/Ped.) |

4.4.2.1 Connecting the sidestream CO2 sensor

WARNING

Connect the CO2 airway adapter per your institution's policy and procedures. Connecting the airway adapter between the flow sensor and the endotracheal tube increases dead space and may contribute to incorrect volume measurements.

Before proceeding, review the safety information in Chapter 1.

To set up CO2 sidestream monitoring

Refer to Figure 4-6.

1. Connect the CO2 module cable to the CO2 connection port (1) on the ventilator.

2. Insert the sample cell (4) into the CO2 module (2). The sample cell clicks into place.

Inserting the sample cell into the module automatically starts the sampling pump. Removing the cell turns the pump off.

3. Perform the zero calibration of the adapter, if necessary, as described in Section 5.4.5 before connecting it to the breathing circuit.
4. Connect the adapter between the inspiratory limb and the flow sensor (or between the inspiratory limb and HMEF, if used).

Figure 4-7 shows a subset of the breathing circuit setup.

The sampling line should face away from the patient.

5. Secure the sampling line safely out of the way.

Figure 4-7. Connecting CO2 adapter (1) to the breathing circuit

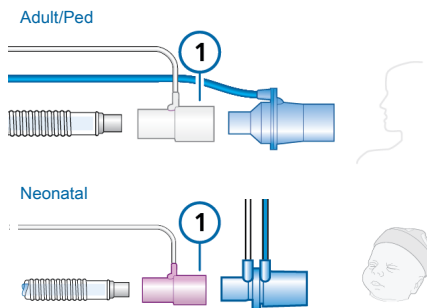

To remove the sample cell

1. Remove the airway adapter from the breathing circuit.
2. Press down on the locking tab and remove the sample cell from the CO2 module.

4.5 Setting up SpO2 monitoring

The HAMILTON-C6 supports input of SpO2 and related pulse oximetry data, and provides integrated monitoring and data display.

Enabling SpO2 measurement on the ventilator requires enabling the SpO2 hardware (in Configuration) and enabling the SpO2 sensor.

Table 4-2. SpO2 measurement overview

For details about ...	See ...
Activating the SpO2 hardware	Section 14.10.2
Enabling the SpO2 sensor	Section 4.6
Working with SpO2 data	<i>Pulse Oximetry Instructions for Use</i>

4.6 Enabling sensors

Before proceeding, review the safety information in Chapter 1.

In addition to hardware activation for CO₂ and SpO₂ measurement (Section 14.10.2), the O₂, CO₂, and/or SpO₂ sensors must be individually enabled for monitoring data to be available.

To enable sensor monitoring

1. Touch **System > Sensors > On/Off**.
2. Select the appropriate checkboxes (O₂ sensor, CO₂ sensor, SpO₂ sensor) to enable/disable the monitoring functions, as desired.

The ventilator always enables O₂ monitoring upon restart.

Figure 4-8. System > Sensors > On/Off window

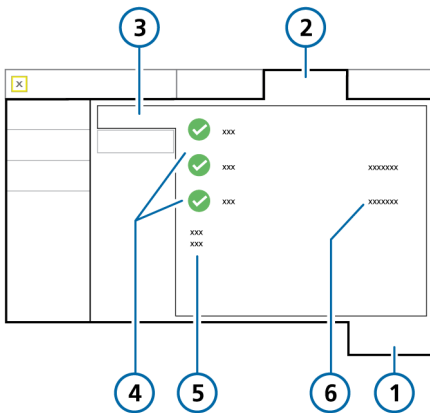

- | | |
|-----------|---|
| 1 System | 4 O ₂ sensor, CO ₂ sensor ¹¹ , SpO ₂ sensor ¹¹ |
| 2 Sensors | 5 SpO ₂ sensor and cable status ¹¹ |
| 3 On/Off | 6 SpO ₂ sensor type ¹¹ |

¹¹ If the option is installed and activated.

¹² Not available in all markets.

¹³ If the option is installed and activated.

4.7 Setting up nebulization

The HAMILTON-C6 supports the following nebulizers types:

- Pneumatic
- Aerogen^{12, 13}

The following figure presents a nebulizer placement example. For other placement options, see the *Nebulizer positioning guidelines* (ELO2020-124-TW), available online on MyHamilton, and the manufacturer's *Instructions for use*.

Figure 4-9. Connecting an Aerogen nebulizer

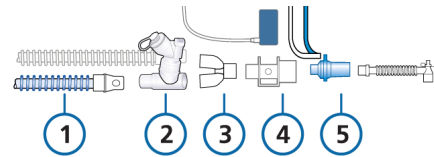

- | | |
|---------------------|---|
| 1 Inspiratory limb | 4 CO ₂ adapter/sensor (optional) |
| 2 Aerogen nebulizer | 5 Flow sensor |
| 3 Y-piece | |

4.7.1 Selecting the nebulization type

By default, Pneumatic is selected for adult and pediatric patients.

To select the nebulizer type

1. Touch **System > Nebulizer**.
2. Touch the appropriate button:
Pneumatic or Aerogen¹⁴

The selected nebulizer is immediately enabled for use.

This setting is saved with each Quick Setup (Section 5.2.1).

4.7.2 Setting up a pneumatic nebulizer

Setting up and using a pneumatic nebulizer comprises the following steps:

Table 4-3. Pneumatic nebulizer setup and use overview

To ...	See ...
Ensure the nebulizer type is set to Pneumatic.	Section 4.7.1
Connect the nebulizer to the breathing circuit and the ventilator, and set it up for use.	This section
Configure duration and breath cycle synchronization settings, and start nebulization.	Section 10.7
Information about supported nebulizers and their operation is also provided.	

To connect a pneumatic nebulizer to the breathing circuit set

1. Connect the nebulizer as shown in Figure 4-10.
2. Connect the nebulizer tubing to the ventilator Nebulizer port (Figure 2-3).

Figure 4-10. Connecting a pneumatic nebulizer

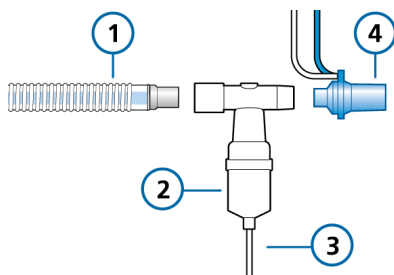

- | | |
|-------------------------------------|----------------------------------|
| 1 Breathing circuit (coaxial shown) | 3 Nebulizer tubing to ventilator |
| 2 Nebulizer | 4 Flow sensor |

For additional details, refer to the manufacturer's Instructions for use.

4.7.3 Setting up an Aerogen nebulizer

Before proceeding, review the safety information in Chapter 1.

Support for the Aerogen nebulizer system is available as an option¹⁵.

The system comprises a communication board component and connection port on the ventilator (Figure 2-3), and the Aerogen Solo or Aerogen Pro nebulizer.

¹⁴ If the Aerogen button is unavailable: The communication board does not have the Aerogen port, the Aerogen option is not activated (see Section 14.10.2), or the option is not available in your area.

¹⁵ Requires the communication board with an Aerogen port, and activation in Configuration.

Setting up and using an Aerogen nebulizer comprises the following steps:

To ...	See ...
In Configuration, enable the Aerogen option. ¹⁶	Section 14.7
Set the nebulizer type to Aerogen.	Section 4.7.1
Connect Aerogen to the breathing circuit and the ventilator, and set it up for use.	<i>Aerogen Solo/Pro Instructions for Use</i>
Configure duration and breath cycle synchronization settings, and start nebulization. Information about supported nebulizers and their operation is provided.	Section 10.7

4.8 Connecting to external devices

You can connect the ventilator to a patient monitor, PDMS, computer, or distributed alarm system using the communication ports on the ventilator. For details, see the *Communication Interface User Guide*, available on MyHamilton.

By connecting the ventilator to a distributed alarm system, you can activate **global AUDIO OFF** for most alarms for an unlimited period of time. For details, see Section 9.5.

¹⁶ Requires the communication board with an Aerogen port.

5

Specifying ventilation settings

5.1	Process overview	82
5.2	Selecting the patient group	82
5.3	Entering patient data	83
5.4	Performing the preoperational check, tests, and calibrations	84
5.5	Selecting the ventilation mode	91
5.6	Setting alarm limits	104
5.7	Starting ventilation	107
5.8	Stopping ventilation	108
5.9	About the control parameters	108

5.1 Process overview

This section explains how to set up the HAMILTON-C6 for ventilation on an individual patient.

Setting up ventilation generally comprises the following steps, each of which is described in this chapter:

- Selecting the patient group
- Selecting the desired preconfigured settings (**Quick setup**)
- Specifying patient data
- Performing the preoperational check, including:
 - Performing a breathing circuit Leak test
 - Calibrating the flow sensor, O2 sensor, and zero calibration of the CO2 sensor
- Testing alarms
- Selecting the ventilation mode
- Reviewing and adjusting control settings
- Reviewing and adjusting alarm limits

5.2 Selecting the patient group

Before proceeding, review the safety information in Chapter 1.

The HAMILTON-C6 supports the following patient groups: **Adult/Ped** (adult and pediatric patients) and **Neonatal**.

Table 5-1. Patient groups

Adult/Ped	Neonatal
Sex: Male, Female	Weight: 0.2 to 30 kg
Height: 30 to 250 cm	Minimum delivered tidal volume: 2 ml
IBW: 3 to 139 kg	
Minimum delivered tidal volume: 20 ml	

To select the patient group and initial settings

1. In the **Standby** window (Figure 5-1), touch the desired patient group tab:

- **Adult/Ped**

- **Neonatal**

- **Last patient.** Reuse the last active ventilator parameters.

The icon for the selected patient group appears to the left of the mode name at the top left of the display (Figure 2-6).

2. For a new patient, touch the desired **Quick setup** button (Section 5.2.1).

The settings saved with the selected **Quick setup** are loaded and displayed, in addition to the default patient sex/height/IBW (**Adult/Ped**) or weight (**Neonatal**).

Figure 5-1. Patient group options in Standby window

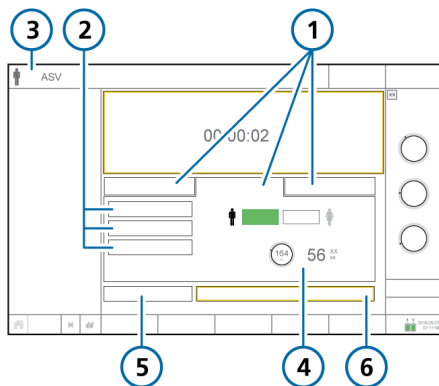

- | | |
|-----------------------------------|--|
| 1 Patient group tabs | 4 Sex/height/IBW (or Weight for Neonatal) for selected Quick setup |
| 2 Quick setups | 5 Preop check |
| 3 Selected mode and patient group | 6 Start ventilation (when HiFlowO2 is selected: Start therapy) |

5.2.1 About Quick setups: preconfigured settings

For each of the patient groups, you can define up to three different default configurations, referred to as **Quick setups**.

During patient setup, you can then quickly pre-configure the ventilator per your standard protocols, and modify settings as needed.

Each **Quick setup** defines a ventilation mode, mode control settings, graphic display selection, alarm limit settings, Vent Status panel settings, Vt/IBW (Adult/Ped patient group) or Vt/kg (Neonatal patient

group), specified humidifier settings (if connected), IntelliCuff Auto settings (if connected), and nebulization settings.

The **Quick setups** are defined in **Configuration** (Chapter 14).

5.3 Entering patient data

CAUTION

Entering the correct patient data ensures safe ventilation settings for start up, Apnea backup, and safety ventilation.

Before proceeding, review the safety information in Chapter 1.

Specifying the correct patient data is particularly important, as the ventilator uses this data as a basis for some calculations and initial mode control settings.

- For the **Adult/Ped** patient group, the ventilator uses sex and patient height to calculate the ideal body weight (IBW).

The following control settings are based on IBW: Vt, Rate, T low, T high, and TI, and Apnea backup and safety settings.

- For **Neonatal** patients, the ventilator uses the patient body weight.

The following parameters are set based on Weight: Vt, Rate, T low, T high, TI, and TI max, and Apnea backup and safety settings.

To enter patient data

- In the **Standby** window:
 - **Adult/Ped.** Specify the patient sex and height. The device calculates the patient IBW.
 - **Neonatal.** Specify the patient weight.

5.4 Performing the preoperational check, tests, and calibrations

The tests and calibrations described in this section help verify the safety and reliability of the ventilator.

If a test fails, troubleshoot the ventilator as indicated or have the ventilator serviced. Make sure the tests pass before you return the ventilator to clinical use.

The test results are stored in memory, including when the ventilator is turned off. This allows the ventilator to be checked and kept in storage, ready for use.

The time and date of the last test is displayed in the **System > Tests & calib.** window. Ensure the last performed preoperational test is valid for your patient.

The audible alarm is paused during calibration, and for 30 seconds thereafter.

Table 5-2. When to perform tests and calibrations

Test or calibration	When to perform
Preoperational check	Before connecting a new patient to the ventilator.
Flow sensor calibration and Leak test	After connecting a new breathing circuit or component (including a flow sensor).
O2 sensor calibration, if needed	After installing a new O2 sensor or when a related alarm occurs. Not required with a paramagnetic O2 sensor.

Test or calibration	When to perform
CO2 sensor/ adapter zero calibration (mainstream/ sidestream)	Required after connecting a CO2 sensor or when a related alarm occurs. Recommended after switching between different airway adapter types.
Alarm tests	As desired

To access tests and calibration functions

- Do either of the following:
 - Touch **System > Tests & calib.**
 - In the **Standby** window, touch **Preop check.**
- Touch the button for the desired operation.

Figure 5-2. System > Tests & calib window

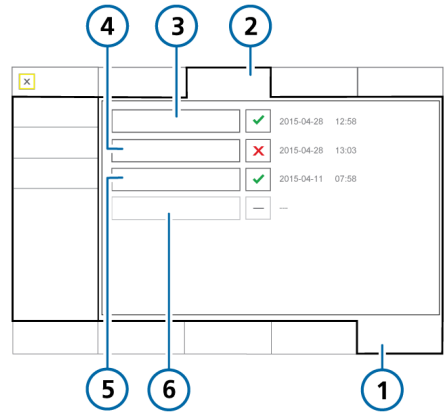

- | | |
|------------------------------------|--|
| 1 System | 5 O2 sensor |
| 2 Tests & calib | 6 CO2 sensor (shown disabled) |
| 3 Leak test | 7 Time and date of last test/calibration |
| 4 Flow sensor (shown uncalibrated) | |

A checkmark indicates the component is calibrated and ready. indicates the calibration was unsuccessful. A box with no marks indicates the test/calibration has not been performed. A grayed-out box indicates the CO2 sensor is not enabled.

5.4.1 Performing the preoperational check

Before proceeding, review the safety information in Chapter 1.

For details about performing the preoperational check with neonatal ventilation, see Section 6.2.

When to perform

Before connecting a new patient to the ventilator.

To perform the preoperational check

1. Use a setup as described in Table 5-3.
2. Perform all of the steps in Table 5-4.

To ensure that the ventilator functions according to specifications on your patient, perform the preoperational check using the breathing circuit that will be used on the patient.

Table 5-3. Test breathing circuit setup

Component	Specification
Breathing circuit	Adult/pediatric, ID10 to ID22 circuit
Flow sensor	Adult/pediatric, with calibration adapter
Test lung	Demonstration lung, 2 liter, with adult ET tube between flow sensor and lung

Table 5-4. Preoperational check, overview

Do or observe...	Verify ...
1 Connect ventilator to primary power and an oxygen supply.	
2 Assemble the patient breathing circuit.	The breathing circuit is assembled correctly.
3 Turn on the ventilator.	During the self test, the alarm lamp flashes red, yellow, and blue, in sequence, and the buzzer sounds briefly.
4 With the ventilator in Standby, touch Preop check in the Standby window.	The System > Tests & calib window opens.
5 Perform the Leak test.	The test passes. See Section 5.4.2.
6 Calibrate the flow sensor.	The calibration is successful. See Section 5.4.3.
7 If necessary, run the O2 sensor calibration.	The calibration is successful. See Section 5.4.4.
8 If necessary, run the CO2 sensor zero calibration.	The zero calibration is successful. See Section 5.4.5.
9 Generate test alarms.	The corresponding alarm message is displayed in the message bar. See Section 5.4.6. Note that patient alarms are suppressed in Standby.

Corrective action

indicates the component is calibrated and ready. indicates the calibration was unsuccessful.

If the ventilator does not pass the preoperational check, have it serviced.

5.4.2 Performing the breathing circuit Leak test

Before proceeding, review the safety information in Chapter 1.

To perform the Leak test

1. Perform the Leak test in **Standby**, with no patient connected.
2. Set up the ventilator for ventilation, complete with breathing circuit and flow sensor.
3. Touch **System > Tests & calib.**
4. Touch **Leak test.**
5. Disconnect the breathing circuit at the patient side of the flow sensor. Do not block the open end of the flow sensor.

The text **Block breathing circuit** is now displayed.

6. Block the opening (wearing a glove is recommended). See Figure 5-3.

Ensure the opening is fully blocked. Failure to do so may result in test failure.

The text **Reconnect breathing system** is now displayed.

7. Reconnect the breathing system.
8. When the test is complete, verify that there is a checkmark in the **Leak test** checkbox.

Figure 5-3. Block the flow sensor opening when prompted

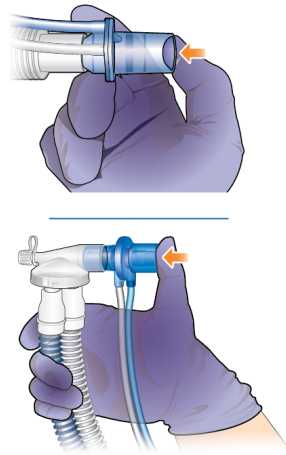

To cancel the test while it is in progress

- ▶ Touch **Leak test** again.

In case of test failure

If the test fails, is displayed in the **Leak test** checkbox.

Ensure that you have performed all steps of the test correctly. If so, perform the following checks, repeating the **Leak** test after each one, until the test is successful:

- Check the breathing circuit for a disconnection between the ventilator and the flow sensor, or for other large leaks (for example, breathing circuit, humidifier).
- Check that the flow sensor and expiratory valve set are properly seated.
- If the test still fails, replace the expiratory valve set.
- If the test still fails, replace the breathing circuit.

If the problem still persists, have the ventilator serviced.

5.4.3 Calibrating the adult/pediatric flow sensor

This calibration checks and resets the calibration points specific to the flow sensor in use, and measures circuit resistance compensation.

Ensure you are using the correct flow sensor for the selected patient group. If there is a mismatch, calibration fails.

For details about calibrating a neonatal flow sensor, see Section 6.2.1.

When to perform

After connecting a breathing circuit or component.

Flow sensor calibration involves three components:

- Flow sensor
- Component in the breathing circuit directly following the flow sensor
- Calibration adapter

To calibrate an adult/pediatric flow sensor

1. Calibrate the flow sensor in **Standby**, with *no* patient connected.
2. Connect the flow sensor to the breathing circuit (Figure 5-4).
3. Connect the *next* component in the circuit to the flow sensor (Figure 5-5).

Depending on your setup, this could be, for example, an HMEF, nebulizer, CO2 sensor, or the flex tube.

Do *not* connect any more components at this time. You will be prompted to connect the calibration adapter once the calibration process starts.

4. In the **Standby** window, touch **Preop check**.

The **System > Tests & calib** window is displayed.

5. Touch **Flow sensor**.

A help guide is shown on the display, providing an overview of the calibration process.

6. Touch **Start** to begin calibration.

To close the guide without starting calibration, touch **Cancel**.

7. When prompted on the display, attach the calibration adapter to the component connected to the flow sensor and flip all three of them together 180° so the adapter is directly connected to the breathing circuit (Figure 5-6).

8. When prompted, flip the flow sensor/component/adaptor 180° again, so the flow sensor is directly connected to the breathing circuit, and remove the calibration adapter (Figure 5-7).
9. When calibration is complete, verify that there is a checkmark in the **Flow sensor** checkbox.
10. When successful, finish assembling the breathing circuit, and continue with other tests or ventilation.

Figure 5-4. Connect the flow sensor

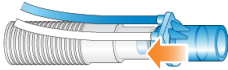

Figure 5-5. Connect the next component



Figure 5-6. Attach adapter, flip components

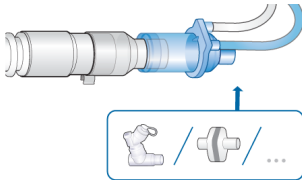
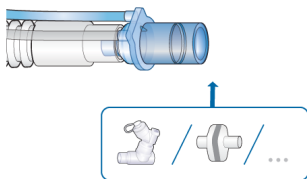

Figure 5-7. Flip components, remove adapter



To cancel an ongoing calibration

- ▶ Touch **Flow sensor** again.

In case of calibration failure

If the calibration fails, is displayed in the **Flow sensor** checkbox.

Ensure that you have performed all steps of the test correctly. If so, perform the following checks, repeating the calibration after each one, until calibration is successful:

- Ensure that the flow sensor is appropriate for the selected patient group.
- Check the breathing circuit for a disconnection between the ventilator and the flow sensor, or for other large leaks (for example, breathing circuit, humidifier).
- Check that the flow sensor and expiratory valve set are properly seated.
- If the calibration still fails, replace the flow sensor.
- If the calibration still fails, replace the expiratory valve membrane.
- If the calibration still fails, replace the expiratory valve set.

If the problem persists, have the ventilator serviced.

5.4.4 Calibrating the O2 sensor

Calibrate the O2 sensor if either of the following occur:

- is displayed in the **O2 sensor** checkbox (Figure 5-2)
- The **O2 sensor calibration needed** alarm is generated.

The paramagnetic O2 sensor is only calibrated once, upon installation.

To perform O2 sensor calibration

- Using the information in Table 5-5, set the **Oxygen** control as appropriate to calibrate the sensor using either 21% or 100% oxygen.
For example, to calibrate during active ventilation with 100% oxygen, ensure the **Oxygen** control is set to 22% or higher.
- Touch **System > Tests & calib.**
- Touch **O2 sensor.**
- When calibration is complete, verify that there is a checkmark in the **O2 sensor** checkbox.

Table 5-5. Oxygen concentration during O2 sensor calibration

Standby or active ventilation	Gas source connection status	Set Oxygen to ...
100% oxygen calibration¹⁷		
Standby	Connected	> 21%
Active ventilation	Connected	> 21%
21% oxygen calibration		
<i>When the oxygen supply is less than 99%, you must disconnect the oxygen supply before calibration.</i>		
Standby	Disconnected	any
Standby	Connected	21%
Active ventilation	Connected	21%

In case of calibration failure

If the calibration fails, a red is displayed in the O2 sensor checkbox.

Perform the following checks, repeating the calibration after each one, until calibration is successful:

- Ensure a Hamilton Medical O2 sensor is installed.
- If the second calibration attempt fails, and you are using a galvanic O2 sensor, replace the sensor.

If the problem persists, have the ventilator serviced.

5.4.5 Performing a zero calibration of the CO2 sensor/adapter

Before proceeding, review the safety information in Chapter 1.

CAUTION

- Always perform zero calibration with the CO2 sensor (mainstream) or CO2 module (sidestream) connected to the airway adapter.*
- Be sure NOT to cover both ends of the airway adapter with your fingers.*

The CO2 adapter zero calibration compensates for optical differences between airway adapters and for sensor drift.

Note that the CO2 sensors are calibrated at the factory; you only need to zero the adapters as described next.

¹⁷ Calibrating at 100% improves the stability of measurements at higher oxygen concentrations during use.

Zero calibration requirements for mainstream CO2 sensors

Perform a zero calibration in the following cases:

- With the first use of the sensor
- When changing between airway adapter types (for example, from single use to reusable)
- When the CO2 calibration needed alarm is generated

Zero calibration requirements for sidestream CO2 sensors

You only need to perform a zero calibration with sidestream CO2 sensors when the CO2 calibration needed alarm is generated.

To ensure all CO2 is dissipated, wait 2 minutes to perform the zero calibration after removing the adapter from the patient's airway.

To perform the zero calibration of the CO2 sensor/adapter (mainstream) and sensor/module (sidestream)

1. Connect the CO2 adapter (1 mainstream) or the CO2 module (2 sidestream) to the CO2 port on the ventilator (Figure 5-8), and ensure CO2 monitoring is enabled.
Wait at least 2 minutes for the device to warm up.
2. Disconnect the CO2 sensor from the breathing circuit.
See Figures 4-5 and 4-7 for the sensor location in the breathing circuit.
3. Attach the CO2 sensor to the adapter (1 mainstream) or snap it into the CO2 module (2 sidestream) (Figure 5-9).

Keep these components away from all sources of CO2, including the patient's and your own exhaled breath, as well as the ventilator exhaust port.

4. Touch **System > Tests & calib.**
5. Touch **CO2 sensor.**
Do *not* move the components during calibration.
6. When the zero calibration is complete, verify that there is a checkmark in the CO2 sensor checkbox.

Figure 5-8. Connecting the components

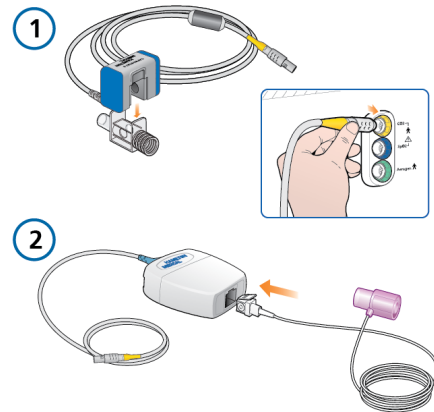
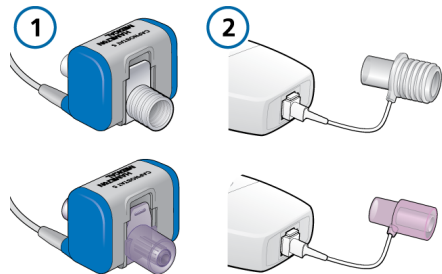



Figure 5-9. Sensor and adapter connected for calibration



In case of zero calibration failure

If the zero calibration fails,  is displayed in the CO2 sensor checkbox.

Perform the following checks, repeating the zero calibration after each one, until it is successful:

- Check the airway adapter and clean if necessary.
- If the zero calibration still fails, ensure there is no source of CO2 near the airway adapter.
- If the zero calibration still fails, connect a new adapter.
- If the zero calibration still fails, connect a new CO2 sensor (mainstream) or CO2 module (sidestream).

If the problem persists, have the ventilator serviced.

5.4.6 Testing the alarms

During ventilator startup, the HAMILTON-C6 performs a self-check that also verifies proper alarm function, including generation of an audible alarm sound. You are *not* required to perform additional alarm tests.

If desired, you can test any adjustable alarm by manually changing the set limit such that the ventilator exceeds or fails to reach the set limit, thereby generating the associated alarm. For details on setting alarm limits, see Section 5.6.

For any tests, use a demonstration lung assembly as described in Section 5.4.1.

5.5 Selecting the ventilation mode

The active ventilation mode is displayed at the top left corner of the display together with the selected patient group.

When first starting to ventilate a patient, the mode associated with the selected **Quick setup** is pre-selected. You can change it, if needed.

For details about each of the modes, see Chapter 7.

To select a mode

1. Do either of the following (see Figure 5-10):
 - Touch the mode name (1) at the top left of the display.
 - Touch **Modes** (2) at the top right of the display.
2. In the **Modes** window, touch the desired mode, then touch **Confirm**.
The **Confirm** button is only displayed after you select a different mode in the window.
The Controls window opens.
3. Review and, if needed, adjust the control settings (Figure 5-12), then touch **Confirm** to enable the new mode.

After you touch **Confirm**, the mode changes at the end of the current breath cycle.

Without confirmation, the window closes after a short time and the currently active mode remains in place.

Figure 5-10. Modes window, changing modes

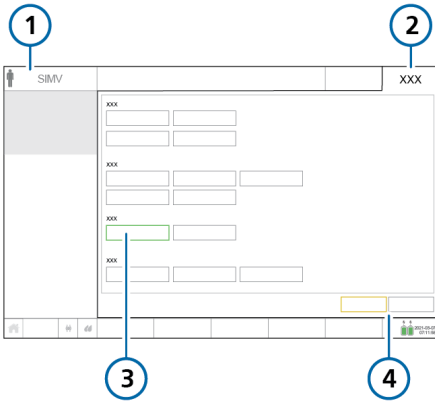

- | | |
|---------------------------------|------------------|
| 1 Active mode,
patient group | 3 New mode |
| 2 Modes | 4 Cancel/Confirm |

Figure 5-11. Controls window, changing modes

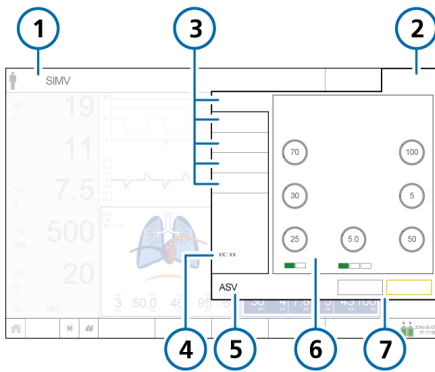

- | | |
|--|-------------------------|
| 1 Active mode,
patient group | 5 New mode |
| 2 Modes | 6 Controls for new mode |
| 3 Tabs: Basic, More,
Apnea, TRC,
Patient | 7 Cancel/Confirm |
| 4 Values depending on mode | |

5.5.1 Reviewing and adjusting ventilation settings

You specify ventilation settings in the Controls window tabs: **Basic**, **More**, **Apnea**, **TRC**. The **Patient** tab provides access to patient data during ventilation.

Which tabs are available depends on which mode is selected, as well as whether you are in **Standby** or active ventilation.

In addition, the window changes slightly depending on whether you are changing settings for the active mode or you are changing modes.

To change the control settings for the active mode

1. Touch **Controls**, and select and adjust settings as needed. See Figure 5-12. The change takes effect immediately. For details about changing the trigger type, see Section 5.5.3.
2. Touch **More** to enable/disable **Sigh**, if needed.
3. If applicable, touch **Apnea** and select or deselect **Backup** as needed.
4. If applicable, touch **TRC** and enable/disable/adjust settings as needed. See Section 5.5.5.
5. If you need to change basic patient data, touch **Patient** and adjust settings as needed. See Section 5.3.

Figure 5-12. Controls window, settings for active mode

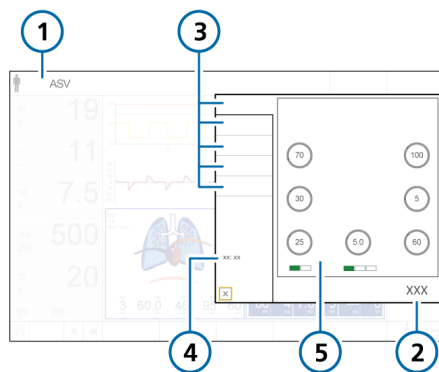

- | | |
|--|--|
| 1 Active mode, patient group | 4 Values depending on mode (minute volume, timing) |
| 2 Controls | 5 Mode controls |
| 3 Tabs: Basic, More, Apnea, TRC, Patient | |

5.5.2 About Plimit and related pressure-control settings

The pressure limit setting (Plimit) defines the maximum allowed pressure to apply during ventilation. This setting is available in the **Controls > Basic** window (Figure 5-12).

Furthermore, the Plimit control setting is directly related to the high Pressure alarm limit, in that changing one of these settings automatically changes the other: The high Pressure alarm limit is always 10 cmH₂O greater than Plimit.

Depending on the selected mode, the following control parameters can be used to set pressure: $\Delta P_{\text{control}}$, ΔP_{insp} , $\Delta P_{\text{support}}$, or P high.

The total inspiratory pressure to be applied is defined as follows:

- $\Delta P_{\text{control}} + \text{PEEP/CPAP}$
- $\Delta P_{\text{support}} + \text{PEEP/CPAP}$
- $\Delta P_{\text{insp}} + \text{PEEP/CPAP}$
- P high¹⁸

If the total inspiratory pressure exceeds Plimit, the ventilator only delivers pressure equal to Plimit. The ventilator cannot deliver the set pressure and the **Pressure limitation** alarm is generated. When this conflict occurs, the Plimit control is highlighted in yellow in the Controls window and the **Check Plimit** alarm is generated.

During active adjustment, you may see the pressure or Plimit controls turn yellow, indicating that total inspiratory pressure exceeds Plimit with the proposed settings. Adjust pressure-related settings to resolve the conflict.

The following examples illustrate each of these cases.

¹⁸ In DuoPAP and APRV modes, P high defines the total inspiratory pressure to be delivered. PEEP/CPAP does not need to be accounted for.

Example 1: Pressure control setting adjustments exceed P_{limit}

Assume the control parameters are set as follows:

- P_{limit} = 32 cmH₂O
- ΔP_{control} = 25 cmH₂O
- PEEP/CPAP = 5 cmH₂O
- Total inspiratory pressure = 30 cmH₂O (ΔP_{control} + PEEP/CPAP in this example)

The total inspiratory pressure of 30 cmH₂O is below P_{limit}. The ventilator delivers the total inspiratory pressure as set.

If you increase ΔP_{control} to 30 cmH₂O, the total inspiratory pressure, which is now 35 cmH₂O, exceeds P_{limit} and the following occurs:

1. P_{limit} (1 in Figure 5-13) is highlighted in yellow, indicating that total inspiratory pressure exceeds P_{limit}
2. Either decrease the pressure control settings or increase P_{limit} to ensure that P_{limit} is equal to or greater than the total inspiratory pressure.

When P_{limit} (1 in Figure 5-17) meets this condition, it is no longer highlighted in yellow.

Figure 5-13. Total inspiratory pressure exceeds P_{limit}

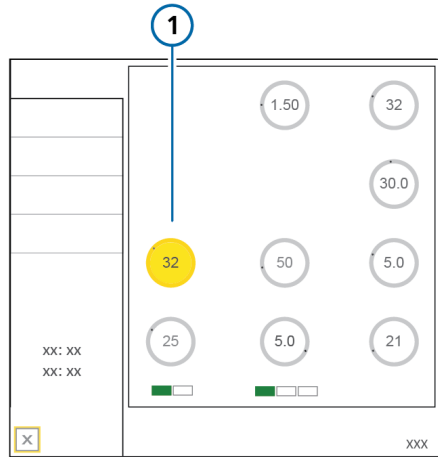
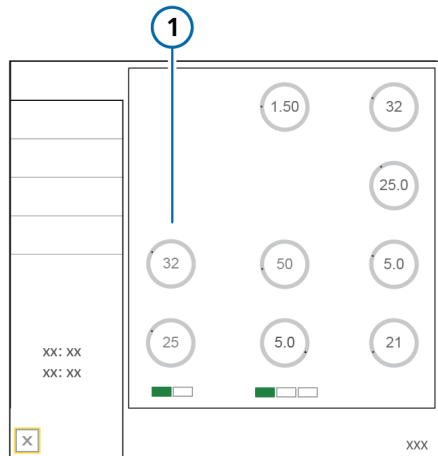

Figure 5-14. Total inspiratory pressure no longer exceeds P_{limit}



Example 2: Plimit setting adjustment is below total inspiratory pressure

Assume the control parameters are set as follows:

Plimit = 32 cmH₂O

$\Delta P_{control}$ = 25 cmH₂O

PEEP/CPAP = 5 cmH₂O

Total inspiratory pressure = 30 cmH₂O
($\Delta P_{control}$ + PEEP/CPAP in this example)

The total inspiratory pressure of 30 cmH₂O is below Plimit. The ventilator delivers the total inspiratory pressure as set.

If you decrease Plimit to 25 cmH₂O, the total inspiratory pressure of 30 cmH₂O exceeds Plimit and the following occurs:

1. The currently active Plimit control that you are adjusting (1 in Figure 5-15) is shown in orange.

The pressure controls are highlighted in yellow (2) if the total inspiratory pressure exceeds Plimit, indicating there is a conflict.

2. Upon confirming the new Plimit setting, Plimit (1 in Figure 5-16) is highlighted in yellow, indicating there is a conflict. The pressure controls return to their default color.

3. Either decrease the pressure control settings or increase Plimit to ensure that Plimit is equal to or greater than the total inspiratory pressure setting.

When Plimit (1 in Figure 5-17) meets this condition, it is no longer highlighted in yellow.

Figure 5-15. Plimit control is active, total inspiratory pressure exceeds Plimit

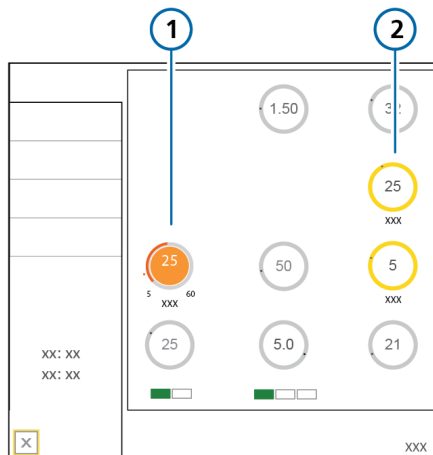

Figure 5-16. Total inspiratory pressure still exceeds Plimit

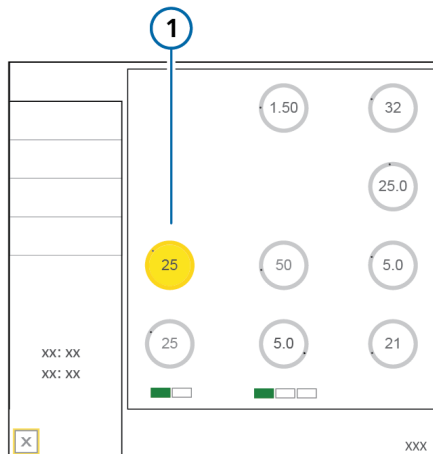
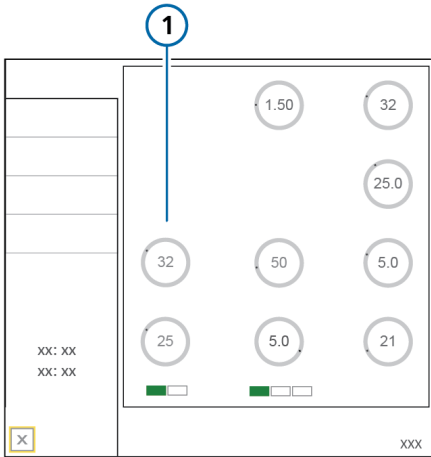

Figure 5-17. Total inspiratory pressure no longer exceeds Plimit



5.5.3 About the trigger types

Before proceeding, review the safety information in Chapter 1.

You can select the conditions that cause the ventilator to trigger inspiration (Section 5.5.3.1) based on flow, pressure, or using the IntelliSync+ trigger¹⁹.



You can also select the conditions that cause the ventilator to trigger expiration (Section 5.5.3.2) based on flow or using the IntelliSync+ trigger¹⁹.

For details about IntelliSync+, see Sections 5.5.3.3 and 5.5.3.4.

5.5.3.1 Selecting the inspiratory trigger type

You can select the inspiratory trigger type to use.

Table 5-6. Inspiratory trigger types

Trigger type	Description
Flow trigger (F) 	The patient's inspiratory flow triggers the ventilator to deliver a breath. When selected, the F indicator under the control is green.
IntelliSync+ ¹⁹ , ²⁰ (I) 	The ventilator monitors incoming sensor signals from the patient and reacts dynamically to initiate inspiration and expiration in real time. When selected, the I indicator under the control is green, and the control itself is blue, displaying the text <i>IntelliSync+</i> .
Pressure trigger (P) 	The drop in airway pressure when the patient tries to inhale triggers the ventilator to deliver a breath. When selected, the P indicator under the control is green.

¹⁹ If the IntelliSync+ option is installed.

²⁰ Not available in all markets.

To specify the inspiratory trigger type and setting

1. Touch **Controls**.

The Controls > Basic window opens.

2. Touch the desired **Trigger** selection button below the control.

The buttons are labeled **F** (flow trigger), **I** (IntelliSync+), and **P** (pressure trigger). The selected trigger type is shown in green.

If **IntelliSync+** is selected, the control turns blue and shows the text, **IntelliSync+**, indicating the ventilator is dynamically adjusting the setting in real-time.

3. If **flow trigger** or **pressure trigger** is selected, adjust the **Trigger** setting as needed.

Note the following:

- Changing the setting during the inspiratory or expiratory phase affects the next breath.
- If the trigger is set higher than the patient's efforts can achieve, a breath cannot be triggered. Reset the trigger to an achievable value, adjusting the sensitivity of the trigger to the patient's ability.

- The ambient valve of the HAMILTON-C6 opens at -3 cmH₂O below ambient pressure. Therefore, be sure to set a pressure trigger setting above this value to ensure accurate trigger sensitivity. For example, if PEEP is set to 5 cmH₂O, **P trigger** must be set to no less than -8 cmH₂O (in total, -3 cmH₂O below ambient), to ensure an accurate trigger sensitivity.

Figure 5-18. Trigger and cycling controls

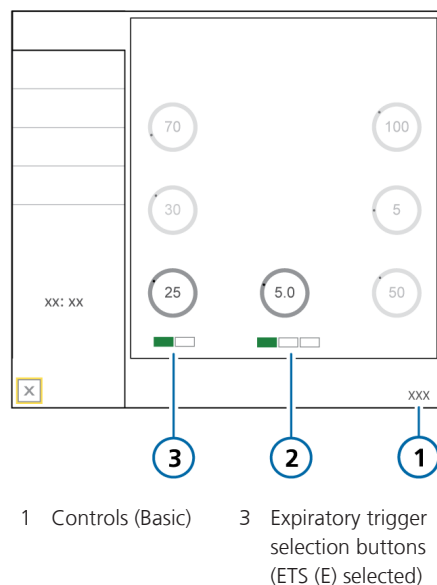

- 1 Controls (Basic)
- 2 Inspiratory trigger selection buttons (Flow trigger (F) selected)
- 3 Expiratory trigger selection buttons (ETS (E) selected)

5.5.3.2 Selecting the expiratory trigger type

You can select the expiratory trigger type to use.

Table 5-7. Expiratory trigger types

Trigger type	Description
ETS (E)	<p>The percent of peak inspiratory flow at which the ventilator cycles from inspiration to exhalation.</p> <p>When selected, the E indicator under the control is green.</p>
IntelliSync+ (I) ²¹	<p>The ventilator monitors incoming sensor signals from the patient and reacts dynamically to initiate inspiration and expiration in real time.</p> <p>When selected, the I indicator under the control is green, and the control itself is blue, displaying the text <i>IntelliSync+</i>.</p>

To specify the expiratory trigger type and setting

1. Touch **Controls > Basic**.
2. Touch the desired expiratory trigger selection button below the control. The buttons are labeled **ETS** and **I** (*IntelliSync+*). The selected option is shown in green.

If *IntelliSync+* is selected, the control turns blue and shows the text, **IntelliSync+**, indicating the ventilator is dynamically adjusting the setting in real-time.
3. If **ETS** is selected, adjust the **ETS** setting as needed.

²¹ If the *IntelliSync+* option is installed.

²² Not available in all markets.

5.5.3.3 About IntelliSync+

CAUTION

- *When using IntelliSync+, observe the waveforms and ensure that the ventilator cycles into inspiration/expiration in synchrony with the patient's attempts to inhale/exhale.*
- *When asynchrony or oscillations (for example, cardiogenic oscillations) are observed, or IntelliSync+ causes patient discomfort, change the trigger type.*

NOTICE

*IntelliSync+*²² is designed for use with all adult and pediatric patients weighing 10 kg or more.

IntelliSync+ is available for adult and pediatric patients in all modes as the inspiratory trigger, and as the expiratory trigger, in all modes except APVcmv, SCMv, PCV+, and APRV. You can use *IntelliSync+* as the inspiratory trigger, expiratory trigger, or both.

When a patient is spontaneously breathing, analysis of the waveforms on the ventilator can reveal the patient's efforts. This analysis is performed by the clinician at the bedside, where ventilation settings can be adjusted to improve patient-ventilator synchrony.

IntelliSync+ is based on a mathematical model that is designed to identify a patient's spontaneous breathing efforts, just as an experienced clinician would observe when determining treatment.

By analyzing waveforms on the ventilator, **IntelliSync+** identifies the patient's attempts to inhale/exhale and triggers the ventilator to initiate inspiration or expiration, as appropriate. **IntelliSync+** continuously performs this analysis in real-time, and thereby can react to changing patient conditions, breath by breath.

When **IntelliSync+** is enabled, it is important that the ventilator trigger inspiration/expiration in synchrony with the patient's efforts. If the ventilator is not applying breaths synchronously, change the trigger type (Section 5.5.3).

You can observe the trigger timing by reviewing the pressure and flow waveforms. Figure 5-19 provides a visual example of synchronous and asynchronous patient-ventilator triggering.²³

Oscillations can also cause **IntelliSync+** to inappropriately trigger (Figure 5-19). If oscillations are observed in the waveforms, change the trigger type.

²³ For additional information about patient-ventilator synchrony, Hamilton Medical provides additional resources, including white papers and quick references, available at hamilton-medical.com.

Figure 5-19. Patient-ventilator trigger synchrony and asynchrony when using IntelliSync+

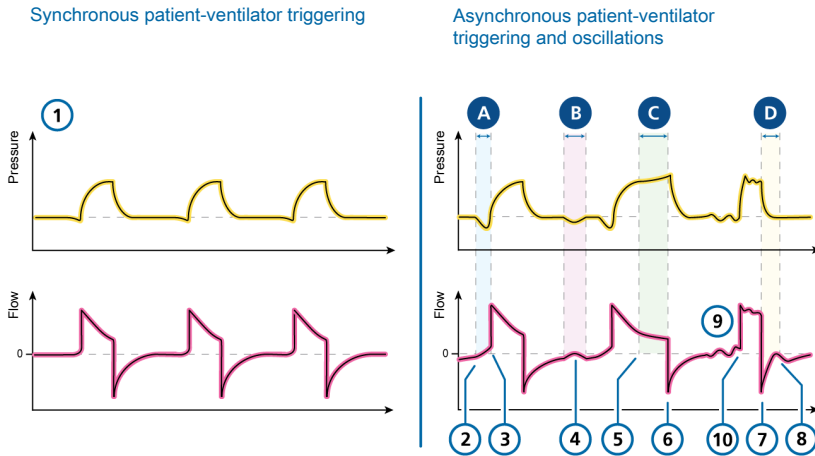

1 Waveforms showing patient-ventilator trigger synchrony in both the inspiratory and expiratory phases

A. Delayed triggering²⁴

- 2 Patient inspiratory effort
- 3 Ventilator initiates inspiration

B. Ineffective effort

- 4 Patient inspiratory effort fails to trigger inspiration

C. Delayed cycling²⁴

- 5 Patient muscles relax (indicating readiness to exhale)
- 6 Ventilator initiates expiration

D. Early cycling²⁴

- 7 Ventilator initiates expiration
- 8 Indication of early expiration by the ventilator (bump in expiratory flow due to ongoing patient inspiratory effort)

Other

- 9 Oscillations
- 10 Auto trigger (caused by oscillations)

²⁴ Triggering refers to the inspiratory trigger; Cycling refers to the expiratory trigger.

5.5.3.4 About IntelliSync+ indicators on the ventilator

When active,  is shown on the uppermost waveform on the display.

Additional symbols are shown on the waveform, indicating the patient trigger and inspiratory time, depending on whether IntelliSync+ is selected as the inspiratory and/or expiratory trigger.

Figure 5-20. IntelliSync+ symbols on the waveform

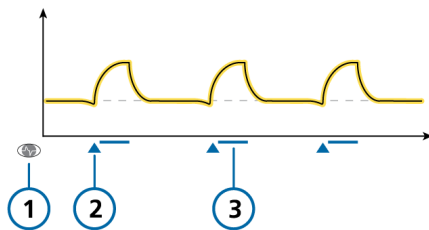

- 1 IntelliSync+ symbol
- 2 Blue patient inspiratory trigger symbol*
- 3 Blue bar indicating inspiratory time**

* When IntelliSync+ is selected as the inspiratory trigger.

** When IntelliSync+ is selected as the expiratory trigger.

5.5.4 About Apnea backup ventilation

Before proceeding, review the safety information in Chapter 1.

The HAMILTON-C6 provides apnea backup ventilation, a mechanism that minimizes possible patient injury due to apnea or cessation of respiration. **Apnea backup** is available in the following modes: APVsimv, SIMV, SPONT, DuoPAP, APRV, and NIV

Apnea backup ventilation enabled

Apnea backup provides ventilation after the apnea time passes with no breath attempts detected. The apnea time is set in the Alarms window using the Apnea time control.

When this occurs, the ventilator automatically and immediately switches into Apnea backup ventilation.

It generates a low-priority alarm, displays the alarm **Apnea ventilation**, and provides ventilation using the settings specified in Section 7.1.2.

When set to **Automatic**, the control setting for the Apnea backup mode depends on the IBW (or weight for neonates) of the patient.

To change the Apnea backup control settings

1. Touch **Controls > Apnea**.
2. Clear the **Automatic** checkbox.
The settings controls are enabled.
3. Change the values as desired.
The changes take effect immediately.

Figure 5-21. Controls > Apnea window

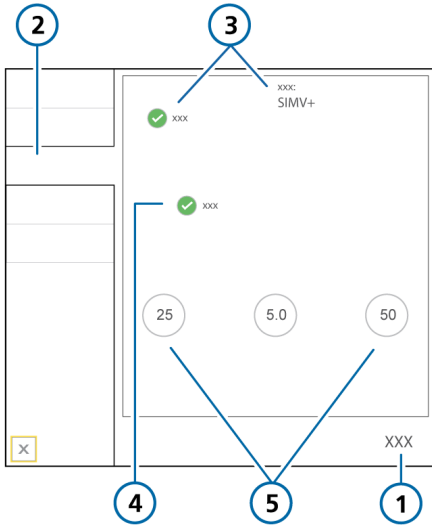

- | | |
|-----------------------------|--|
| 1 Controls | 4 Automatic check box |
| 2 Apnea | 5 Control settings corresponding to the mode |
| 3 Backup check box and mode | |

If the patient triggers two consecutive breaths, the ventilator reverts to ventilation in the original support mode and at the original settings, and displays the message, **Apnea ventilation ended**.

Once **Apnea backup** ventilation is enabled or disabled, it retains this status in all applicable modes. **Apnea backup** ventilation requires no clinician intervention, although you can freely change the mode during **Apnea backup** ventilation, either switching to a new mode or accepting the backup mode as the new mode.

Apnea backup ventilation disabled

When **Apnea backup** is disabled, the high-priority **Apnea** alarm is generated when apnea occurs and there is no patient trigger within the operator-set interval.

5.5.5 About tube resistance compensation (TRC)

Before proceeding, review the safety information in Chapter 1.

TRC is intended for use with spontaneously breathing patients.

Tube resistance compensation (TRC) is flow-proportional pressure support to compensate the flow resistance of the used endotracheal tube (ET tube) or tracheostomy tube (Trach tube).

100% compensation indicates that resistance due to the tube itself is compensated. Note that internal resistance (for example, from secretions) and external resistance (for example, from tube kinking) are not compensated.

TRC can be enabled or disabled for the expiration phase, as well.

By default, TRC is disabled.

When TRC is enabled:

- The additional work of breathing due to the tube can be partially or completely compensated.
- The tracheal pressure (Ptrach) waveform (orange) is shown together with the Paw waveform (yellow).

- At the beginning of the inspiratory phase, the pressure will be higher than without TRC, and will drop below PEEP at the beginning of the exhalation phase to compensate the flow-dependent resistance. See Figure 5-22 for an example.
- The displayed P_{peak} may be higher than the set PEEP/CPAP plus $\Delta P_{\text{control}}$ / $\Delta P_{\text{support}}$ due to the additional pressure required to work against the tube resistance.

Figure 5-22. Ptrach (orange) and Paw (yellow) waveforms, with TRC active

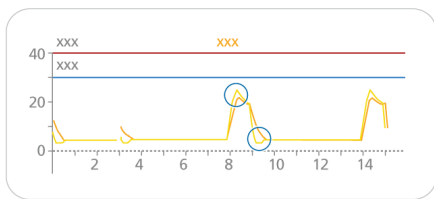

The Ptrach waveform is calculated as follows:

$$\Delta P_{\text{ETT}} = K_{\text{tube}} \times \dot{V}$$

where

ΔP_{ETT} Flow-proportional pressure drop over the tube. This is the difference between the Ptrach and Paw waveforms.

K_{tube} Tube coefficient (k-factor). Dependent on inner diameter and length of tube, is equal to flow/resistance at a flow of 1 liter per second (l/s).

\dot{V} Flow of the breathing gas.

To specify TRC settings

Refer to Figure 5-23.

1. Touch **Controls** > **TRC**.
2. To set the ET tube compensation settings, touch **ET tube**.
To set the tracheostomy tube compensation settings, touch **Trach tube**.
3. Using the Tube ID and Compensate controls, specify the tube diameter (in mm) and compensation percentage (%) to apply (Figure 5-23).
If the tube is shortened, reduce the compensation percentage.
4. If desired, select the **Expiration** checkbox to also activate compensation during exhalation.²⁵
5. To disable TRC if it has been enabled, touch **Disable TRC**.
6. Touch **Apply** to confirm the settings.

²⁵ When changing modes to (S)CMV, if Expiration compensation is disabled, TRC is deactivated.

Figure 5-23. Controls > TRC window

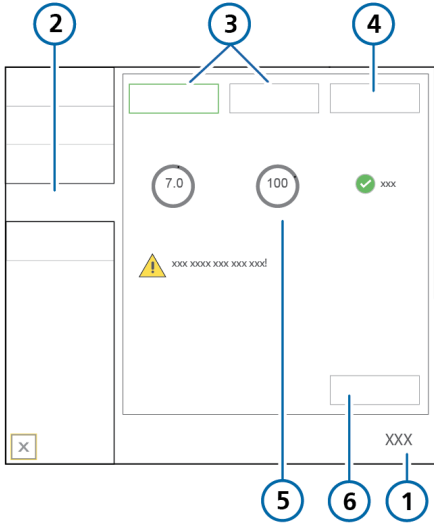

- | | |
|---------------------|---|
| 1 Controls | 4 Disable TRC |
| 2 TRC | 5 Tube ID and Compensate controls, Expiration |
| 3 ET and Trach tube | 6 Apply |

5.6 Setting alarm limits

Before proceeding, review the safety information in Chapters 1 and 9.

You can access the Alarms window and change alarm settings at any time, without affecting ventilation.

Figure 5-24. Alarms > Limits 1 window

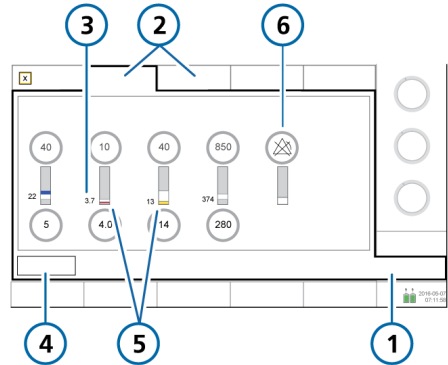

- | | |
|-----------------------------|---|
| 1 Alarms | 4 Auto ^{26, 27} |
| 2 Limits 1, 2 ²⁸ | 5 Red or yellow bar (depending on alarm priority) indicates the monitored value is out of range |
| 3 Current monitored value | 6 Alarm Off symbol when an alarm limit is set to Off |

²⁶ Not available during neonatal ventilation.

²⁷ Not available in all markets.

²⁸ If the Masimo rainbow SET pulse oximetry option is activated, related parameters are shown on the Limits 3 tab.

To review and adjust alarms

1. Either touch the **Alarms** button or touch an MMP on the left of the display.
The Alarms > Limits 1 window is displayed (Figure 5-24).
2. To set an alarm limit individually, touch the alarm control and adjust the value.
Repeat for any other alarm.
3. Access additional alarm settings by touching the **Limits 2**, and if used, **Limits 3** tabs.

The ventilator displays  (Alarm Off symbol) when an alarm limit is set to Off.

For details about the **Oxygen** alarm limits, including when you can manually set them, see Section 14.3.6.

4. To set alarm limits automatically, touch **Auto** in the Limits 1 window.^{29,30,31}
Selecting **Auto** automatically sets alarm limits around the current monitoring parameter values except for the **Vt** and **Apnea** alarm limits. These alarm limits remain unchanged, and must be set manually to the desired level.
Note that some automatic settings are not appropriate under all clinical conditions. Check the validity of the settings as soon as possible.
5. Close the window.

The following table briefly describes each of the adjustable ventilator alarms. Additional details are available in Table 16-9.

For SpO₂-related alarms, see the *Pulse Oximetry Instructions for use*.

²⁹ Not available during neonatal ventilation.

³⁰ SpO₂-related alarms are also not automatically set.

³¹ Not available in all markets.

Table 5-8. Adjustable alarms

Alarm	Definition
Apnea time	<p>The maximum time allowed from the beginning of one inspiration to the beginning of the next inspiration.</p> <p>If the patient does not trigger a breath during this time:</p> <ul style="list-style-type: none"> • A low-priority alarm sounds if Apnea backup is enabled. Apnea ventilation begins. • A high-priority alarm sounds if Apnea backup is disabled <p>The Apnea alarm can be turned off in nCPAP-PS mode.</p>
ExpMinVol (low and high)	<p>Low and high expiratory minute volume. If either limit is reached, a high-priority alarm is generated.</p>
fTotal (low and high)	<p>Low and high monitored total breath rate (fTotal), including both spontaneous and mandatory breaths. If either limit is reached, a medium-priority alarm is generated.</p>
Oxygen (low and high)	<p>Low and high monitored oxygen concentration (Oxygen). If either limit is reached, a high-priority alarm is generated.</p> <p>You can only adjust the Oxygen alarm limits when the Set Oxygen alarm limits manually checkbox is selected in Configuration. See Section 14.3.6.</p>
PetCO2 (low and high)	<p>Low and high monitored PetCO2. If either limit is reached, a medium-priority alarm is generated.</p>
Pressure (low and high)	<p>Low and high monitored pressure at the patient airway (Ppeak). If the high Pressure limit is reached or the device fails to reach the low Pressure limit, a high-priority alarm is generated.</p> <p>When pressure reaches the Plimit setting (high Pressure limit minus 10 cmH2O), pressure is limited to this setting; the pressure is not increased further.</p> <p>If the delivered pressure is the same as the set high Pressure alarm limit, the device aborts the breath and reduces the pressure to PEEP level.</p> <p>Sigh breaths are an exception to this rule. In this case, the ventilator may apply inspiratory pressure 3 cmH2O below the high Pressure alarm limit.</p>

Alarm	Definition
Vt (low and high)	<p>Low and high expiratory tidal volume, for two consecutive breaths. If either limit is reached, a medium-priority alarm is generated.</p> <p>When the delivered Vt is more than 1.5 times the set upper Vt alarm limit, the Inspiratory volume limitation alarm is generated. In this case, the device aborts the breath and reduces the pressure to PEEP level.</p> <p>The APV controls reduce the pressure for the next breath by 3 cmH2O.</p>

5.6.1 About the Oxygen alarm limits

By default, the **Oxygen** high/low alarms are automatically set to the current **Oxygen** setting ± 5 (absolute value). The **Oxygen** alarm limit controls are disabled in the **Alarms** window.

If the **Set Oxygen** alarm limits manually option is selected in **Configuration**, the **Oxygen** alarm limit controls are enabled in the **Alarms > Limits 2** window and can be adjusted as appropriate. For details, see Section 14.3.6.

5.7 Starting ventilation

Before starting ventilation, review the patient information in the **Standby** window and ensure it is correct.

To start ventilation

- ▶ Do either of the following:
 - In **Standby**, press the **Power/Standby** key.
 - In **Standby**, touch **Start ventilation**.
 - Using the **P&T** knob, move the cursor to the **Start ventilation** button, and press the **P&T** knob.
- If the mode selected is **HiFlowO2**, the button is labeled **Start therapy**.

Ventilation starts.

During active ventilation, the **Power/Standby** key light is white.

5.8 Stopping ventilation

To enter Standby and stop ventilation

1. Press the **Power/Standby** key.
2. In the confirmation window, touch **Activate standby**.

The device enters **Standby** (Figure 5-1). The yellow counter shows the time elapsed in **Standby**.

When in **Standby**, the **Power/Standby** key light is green.

5.9 About the control parameters

Table 5-9 briefly describes each of the ventilator control parameters.

Table 16-5 in the Specifications chapter provides the control parameter ranges and default settings, including accuracy.

Table 5-9. Control parameters, defined

Parameter	Definition
%MinVol	Percentage of minute volume to be delivered in ASV mode. The ventilator uses the %MinVol, Pat. height, and sex settings to calculate the target minute ventilation. Add 20% per degree of body temperature > 38.5°C (101.3°F).
Apnea backup	A function that provides ventilation after the adjustable apnea time passes without breath attempts. If Automatic is enabled, control parameters are calculated based on the patient's IBW . Applies in APVsimv , SIMV , SPONT , DuoPAP , APRV , and NIV modes. <i>Be sure to review the safety information in Chapter 1.</i>
ETS	See Trigger , expiratory.
Flow	In HiFlowO2 , Flow is the continuous and constant flow of medical gas to the patient in liters per minute.
Flow pattern	Flow pattern for gas delivery. This is not affected by patient pressure or other limitations as long as the peak inspiratory flow or pressure limit is not exceeded. Applies to volume-controlled mandatory breaths.
Flow trigger	See Trigger , inspiratory.
HAMILTON-H900-related parameters	Displayed when a HAMILTON-H900 humidifier is connected. See Section 12.1.7.
I:E	Ratio of inspiratory time to expiratory time. Applies to mandatory breaths.

Parameter	Definition
IBW (kg)	Ideal body weight. A calculated value using height and sex, used in calculations for ASV and startup ventilation settings for adult and pediatric patients.
IntelliCuff-related parameters	Displayed when an IntelliCuff cuff pressure controller is connected. See Section 12.2.8.
Oxygen	Oxygen concentration to be delivered. Applies to all breaths and with HiFlowO2.
P high	The high pressure setting in APRV and DuoPAP modes. Absolute pressure, including PEEP.
P low	The low pressure setting in APRV mode.
Pat. height	Patient height. Used to compute ideal body weight (IBW) for adult and pediatric patients.
Pause	Inspiratory pause or plateau, as a percentage of total breath cycle time. After the required gas is delivered (after the operator-set Vt is reached), gas remains in the lungs and exhalation is blocked during the Pause time. The use of a pause increases the residence time of gas in the patient's lungs. Applies to volume-controlled mandatory breaths, when the device is configured in this manner (Section 14.4.1).
Peak flow	Peak (maximum) inspiratory flow. Applies to volume-controlled mandatory breaths, when the device is configured in this manner (Section 14.4.1).
PEEP/CPAP	Positive end expiratory pressure and continuous positive airway pressure, baseline pressures applied during the expiratory phase. Applies to all breaths, except in APRV mode and with HiFlowO2.
Plimit	The maximum allowed pressure to apply during ventilation. Does not apply in (S)CMV mode, with Sigh breaths, or in HiFlowO2. Changing Plimit or the high Pressure alarm limit automatically changes the other: the high Pressure alarm limit is always 10 cmH2O greater than Plimit. When adjusting the pressure controls, the ventilator indicates when the total inspiratory pressure (including PEEP/CPAP) exceeds Plimit. For details, see Section 5.5.2. In ASV mode, Plimit must be at least 15 cmH2O above PEEP/CPAP for the ASV controller to function correctly.

Parameter	Definition
P-ramp	<p>Pressure ramp. The rate at which pressure rises to meet the set value. The P-ramp setting lets you fine-tune the initial flow output during a pressure-controlled or pressure-supported breath to match the ventilator flow to the patient's demand. Applies to all breaths.</p> <p>Notes:</p> <ul style="list-style-type: none"> • Short P-ramp settings (0 to 50 ms) provide higher initial flow rates and result in faster attainment of the target pressure. This may benefit patients with elevated respiratory drive. • Shorter P-ramp values have been correlated with reduced work of breathing in certain patients. • Setting the P-ramp too low, especially in combination with a small ET tube (high resistance), may result in a noticeable pressure overshoot during the early stage of inspiration and generation of a Pressure limitation alarm. • Setting the P-ramp too high may prevent the ventilator from attaining the set inspiratory pressure. A square (rectangular) pressure profile is the goal.
Pressure trigger	See Trigger, inspiratory.
Rate	Respiratory frequency or number of breaths per minute.
Sex	Sex of patient. Used to compute ideal body weight (IBW) for adult and pediatric patients.
Sigh	<p>When Sigh is activated, every 50th breath is applied using one of the following settings:</p> <ul style="list-style-type: none"> • In pressure-controlled modes, the pressure delivered is > 10 cmH₂O above the currently set $\Delta P_{Control}$ or ΔP_{Insp}. • In volume-controlled modes, the tidal volume delivered is 150% of the current tidal volume (V_t) setting. <p>During Sigh breaths, the Pressure and Vt alarm limits remain in effect to help protect the patient from excessive pressures and volumes.</p> <p>Not available for neonatal patients, in DuoPAP or APRV modes, or with HiFlowO₂.</p>
T high	Length of time at the higher pressure level, P high , in DuoPAP and APRV modes.
T low	Length of time at the lower pressure level, P low , in APRV mode.

Parameter	Definition
TI	<p>Inspiratory time, the length of time to deliver gas for inspiration at the $\Delta P_{control}$ or V_t setting. Used with Rate to set the breath cycle time.</p> <p>Applies in (S)CMV, SIMV, PCV+, APVcmv, APVsimv, PSIMV+, NIV-ST, and nCPAP-PS modes.</p> <p>In PCV+, APVcmv, (S)CMV, and SIMV modes, TI can be controlled by Rate and TI or by the I:E ratio (set in Configuration). All other modes are controlled by Rate and TI.</p>
TI max	<p>Maximum inspiratory time for flow-cycled breaths in the following modes:</p> <ul style="list-style-type: none"> All patient groups: NIV and NIV-ST Neonatal patient group: APVsimv, PSIMV+, DuoPAP, SPONT, and nCPAP-PS <p>In Configuration, you can enable the TI max control setting for the following modes:</p> <ul style="list-style-type: none"> Adult/Ped patient group: APVsimv, PSIMV+, DuoPAP, and SPONT <p>For all patient groups, the switchover from inspiration to exhalation in spontaneous breaths is normally controlled by the ETS or IntelliSync³². If gas leakage is significant, however, the set cycle may never be reached. The TI max setting provides a backup so inspiration can be terminated. The ventilator switches over to exhalation when the set TI max is reached.</p>
Tip	<p>Inspiratory pause or plateau time.</p> <p>After the required gas is delivered (after the operator-set V_t is reached), gas remains in the lungs and exhalation is blocked during the Tip time.</p> <p>The use of an inspiratory pause increases the residence time of gas in the patient's lungs.</p> <p>Applies to volume-controlled mandatory breaths, when the device is configured in this manner (Section 14.4.1).</p>
TRC: Compensate	Compensation percentage (%).
TRC: Expiration	Activate compensation during exhalation.
TRC: Tube ID	Inner diameter of the tube, in mm.
TRC: Tube type/ Disable TRC	Options are: ET (endotracheal) tube, Trach (tracheostomy) tube, Disable TRC (TRC off)

³² If the IntelliSync+ option is installed.

Parameter	Definition
TRC-related settings	<p>Tube resistance compensation. Reduces the patient's work of breathing by offsetting tube resistance.</p> <p><i>Review the safety information in Chapter 1.</i></p>
Trigger, expiratory	<p>The ventilator offers the following expiratory trigger types: ETS and IntelliSync+^{32, 27}, which apply to all breaths.</p> <p>For details on selecting the trigger to use, see Section 5.5.3.2.</p> <p>ETS (expiratory trigger sensitivity)</p> <p>The percent of peak inspiratory flow at which the ventilator cycles from inspiration to exhalation.</p> <p>Increasing the ETS setting results in a shorter inspiratory time. The ETS setting lets you match the inspiratory time of pressure-supported breaths to the patient's neural timing.</p> <p>IntelliSync+</p> <p>With IntelliSync+, the ventilator monitors incoming sensor signals from the patient and reacts dynamically to initiate inspiration and expiration in real time.</p>
Trigger, inspiratory	<p>The ventilator offers the following trigger types: Flow, Pressure, and IntelliSync+³², which apply to all breaths.</p> <p>For details on selecting the trigger to use, see Section 5.5.3.</p> <p>If the trigger is set higher than the patient is able to meet, a breath cannot be triggered. Reset the trigger to an achievable value, adjusting the sensitivity of the trigger to the patient's ability.</p> <p>Flow</p> <p>The patient's inspiratory flow that triggers the ventilator to deliver a breath.</p> <p>IntelliSync+</p> <p>With IntelliSync+, the ventilator monitors incoming sensor signals from the patient and reacts dynamically to initiate inspiration and expiration in real time.</p> <p>Pressure</p> <p>The drop in airway pressure when the patient tries to inhale triggers the ventilator to deliver a breath.</p> <p>Changing the setting during the:</p> <ul style="list-style-type: none"> • <i>Inspiratory phase</i> affects the next breath • <i>Expiratory phase</i> affects the breath after the next

Parameter	Definition
Vt/kg	Tidal volume per weight.
Vt	Tidal volume delivered during inspiration in APVcmv, APVsimv, (S)CMV, and SIMV modes.
Weight	Actual body weight. Used only with neonates.
$\Delta P_{\text{control}}$	The pressure (additional to PEEP/CPAP) to apply during the inspiratory phase in PCV+ and PSIMV+ modes.
ΔP_{insp}	Pressure (additional to PEEP/CPAP) to apply during the inspiratory phase. Applies in PSIMV+ PSync, NIV-ST, and nCPAP-PS modes.
$\Delta P_{\text{support}}$	<p>Pressure support for spontaneous breaths in SPONT, NIV, APVsimv, PSIMV+, and DuoPAP modes. It is the pressure (additional to PEEP/CPAP) to apply during the inspiratory phase.</p> <p>Pressure support helps the patient counteract the flow resistance of the breathing circuit and endotracheal tube. It compensates for the decreasing tidal volume and rising respiratory rate of a spontaneously breathing patient.</p>

6

Specifying neonatal settings

6.1	Setting up for neonatal ventilation	116
6.2	Performing the preoperational check, tests, and calibrations	119
6.3	Selecting the ventilation mode	121
6.4	Setting the patient weight for ventilation	122
6.5	Alarms for neonatal ventilation	122
6.6	O2 enrichment for neonates	122

6.1 Setting up for neonatal ventilation

Before proceeding, review the safety information in Chapter 1.

Setting up for neonatal ventilation comprises the following steps:

To ...	See ...
On the ventilator, select the patient group and specify weight.	Section 6.1.1
Install the expiratory valve.	Section 3.4.2
Select and assemble the appropriate breathing circuit and components.	Section 6.1.2
Adjust the position of the breathing circuit.	Section 6.1.2.5
Connect external devices.	Chapter 4
Perform the preoperational check and any required tests and calibrations.	Sections 6.2 and 5.4
Select the ventilation mode.	Sections 6.3 and 5.5

6.1.1 Setting the patient group and weight

⚠ CAUTION

Entering the correct patient data ensures safe ventilation settings for start up, Apnea backup, and safety ventilation.

You select the patient group and weight in the **Standby** window when first setting up the ventilator for the patient.

You can edit this information during ventilation, if needed, in the **Patient** window.

Figure 6-1. Neonatal Standby window

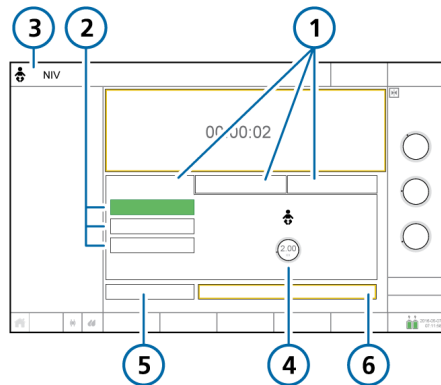

- | | |
|--|--|
| 1 Patient group tabs (Neonatal selected) | 4 Weight |
| 2 Quick setup buttons | 5 Preop check |
| 3 Selected mode and patient group | 6 Start ventilation (when HiFlowO2 is selected: Start therapy) |

To select the patient group

1. In the **Standby** window, touch the **Neonatal** tab. See Figure 6-1.
2. Touch the appropriate **Quick setup** button.
By default, they are labeled **Neonatal 1**, **Neonatal 2**, and **Neonatal 3**. The **Quick setup** names and settings are defined in **Configuration**. For details, see Section 5.2.1.
3. Touch the **Weight** control and set the patient's body weight.
By default, the weight is set to 2 kg.

You can now select the ventilation mode, if the desired mode is not already selected.

6.1.2 Setting up the patient breathing circuit

Setting up a neonatal breathing circuit comprises the following steps:

Table 6-1. Assembling the breathing circuit

To ...	See ...
Select the components	Section 6.1.2.1
Connect the breathing circuit	Section 6.1.2.2
Connect the flow sensor	Section 6.1.2.4
Position the circuit	Section 6.1.2.5

6.1.2.1 Selecting the breathing circuit components

Select the correct breathing circuit and components for your patient from Table 6-2.

Table 6-2. Neonatal breathing circuit part specifications

Patient group/component	Specification
Patient group	Neonatal
Weight (kg)	0.2 to 30
Breathing circuit tube ID (mm)	10 to 12
Flow sensor	Neonatal
CO2 airway adapter	Neonatal

6.1.2.2 Connecting the neonatal breathing circuit

Figures 2-9 through 2-11 in Chapter 2 show typical neonatal breathing circuit configurations.

6.1.2.3 Working with the expiratory valve

The process is the same as for adult and pediatric patients. See Section 3.4.2.

6.1.2.4 Connecting the neonatal flow sensor

Note the following:

- Use a Hamilton Medical neonatal flow sensor to ventilate your neonatal patient.
- Do *not* use an adult/pediatric flow sensor.
- The neonatal flow sensor adds 1.3 ml of dead space.
- During calibration, the flow sensor is *always* placed after the Y-piece, regardless of which ventilator mode is selected.

To connect the neonatal flow sensor

1. For all modes except nCPAP-PS or when using HiFlowO2, connect a flow sensor between the Y-piece of the breathing circuit and the patient connection. See Figure 6-2.

When using the nCPAP-PS mode, connect the flow sensor between the end of the expiratory limb and the expiratory valve on the ventilator (Figure 6-3).

Note that during calibration you place the flow sensor proximal to the patient.

HiFlowO2 does not use a flow sensor.

2. Connect the blue and clear tubes to the flow sensor connection ports on the ventilator.

The blue tube attaches to the blue connection port. The clear tube attaches to the silver connection port.

3. Calibrate the flow sensor and perform the Leak test. See Section 6.2.

Figure 6-2. Connect flow sensor between the Y-piece and patient interface

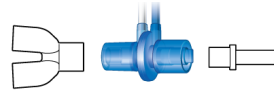
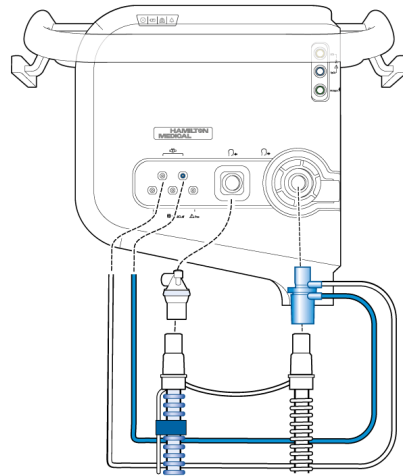

Figure 6-3. Connecting the flow sensor to the expiratory valve, nCPAP-PS mode



6.1.2.5 Positioning the breathing circuit

After assembly, position the breathing circuit so that the hoses will *not* be pushed, pulled, or kinked as a result of a patient's movement, transport, or other activities, including scanner bed operation and nebulization.

6.2 Performing the preoperational check, tests, and calibrations

Before proceeding, review the safety information in Chapter 1.

The following sections in this chapter provide information that is specific to neonatal ventilation, and is intended as a supplement to the information provided in Chapter 5.

For details about when to perform the tests, and about the full preoperational check process, see Section 5.4.

When to perform

Before connecting a new patient to the ventilator.

To perform the preoperational check

1. Use a setup as described in Table 6-3.
2. Perform all of the steps in Table 6-4.

To ensure that the ventilator functions according to specifications on your patient, perform the preoperational check using the breathing circuit that will be used on the patient.

Table 6-3. Test breathing circuit setup

Component	Specification
Breathing circuit	Neonatal, ID10 to ID12
Flow sensor	Neonatal, with calibration adapter
Test lung	Neonatal, with neonatal ET tube between flow sensor and lung model (an IngMar neonatal lung model is recommended)

Table 6-4. Preoperational check, overview

To ...	See ...
Perform the preoperational check	Section 5.4 in Chapter 5
Perform the Leak test	Section 5.4.2 in Chapter 5
Calibrate the neonatal flow sensor	Section 6.2.1
Perform other calibrations, as needed	Section 5.4 in Chapter 5

6.2.1 Calibrating the neonatal flow sensor

Calibrate the flow sensor after connecting a new flow sensor or whenever the **Flow sensor calibration needed** alarm is generated.

During calibration, the flow sensor is *always* placed after the Y-piece, regardless of which ventilator mode is selected.

The flow sensor must be calibrated with the breathing circuit before use. Before proceeding, ensure you have the calibration adapter available.

To calibrate a neonatal flow sensor

1. Calibrate the flow sensor in **Standby**, with no patient connected.
2. Make sure that the **Neonatal** patient group is selected, a neonatal flow sensor is connected, and the calibration adapter is available.
3. Set up the ventilator for ventilation, connecting the flow sensor to the Y-piece.
4. In the **Standby** window, touch **Preop check**.

The **System > Tests & calib** window is displayed.

5. Touch **Flow sensor**.
A help guide is shown on the display, providing an overview of the calibration process.
6. Touch **Start** to begin calibration.
To close the guide without starting calibration, touch **Cancel**.

7. When prompted on the display, attach the calibration adapter to the patient end of the flow sensor (Figure 6-4).
8. When prompted, flip the flow sensor and calibration adapter together 180° so the adapter is directly connected to the Y-piece (Figure 6-5).
9. When prompted, flip the flow sensor/ adapter 180° again, so the flow sensor is directly connected to the Y-piece, and remove the calibration adapter (Figure 6-6).
10. When calibration is complete, verify that there is a checkmark in the **Flow sensor** checkbox.
11. When successful, finish assembling the breathing circuit, and continue with other tests or ventilation.

Figure 6-4. Attach adapter

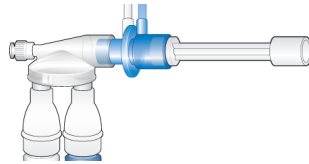

Figure 6-5. Flip components

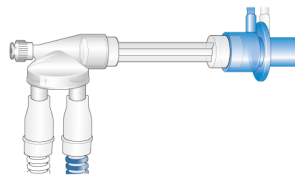
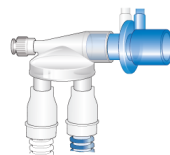

Figure 6-6. Flip components, remove adapter



In case of calibration failure

If the calibration fails, is displayed in the **Flow sensor** checkbox.

Perform the following checks, repeating the calibration after each one, until calibration is successful:

- Ensure that the flow sensor is appropriate for the selected patient group.
- Check the breathing circuit for a disconnection between the ventilator and the flow sensor, or for other large leaks (for example, breathing circuit, humidifier).
- Check that the correct flow sensor is connected, and that the flow sensor and expiratory valve/membrane are properly seated.
- If the calibration still fails, replace the flow sensor.
- If the calibration still fails, replace the expiratory valve membrane.
- If the calibration still fails, replace the expiratory valve set.

If the problem persists, have the ventilator serviced.

6.3 Selecting the ventilation mode

The neonatal modes available on the ventilator are either pressure controlled or adaptive (pressure regulated and volume targeted) modes.

Note that the ventilator generates a continuous and constant base flow from the inspiratory outlet to the expiratory outlet during the later part of exhalation.

For the list of supported modes and details about each one, see Chapter 7.

Figure 6-7. Modes window, Neonatal

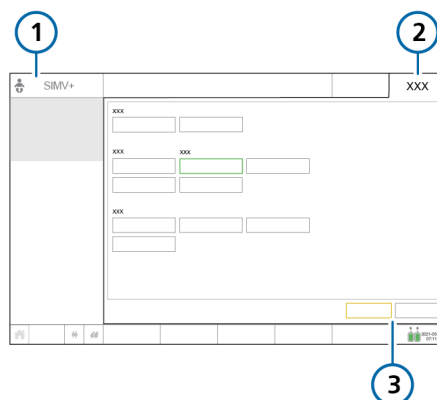

- 1 Active mode, patient group
- 2 Modes
- 3 Cancel/Confirm

To select the ventilation mode

- ▶ See Section 5.5.

6.4 Setting the patient weight for ventilation

For neonates, the ventilator uses actual body weight (instead of a calculated IBW), set in the **Weight** control.

Specifying the correct weight is particularly important as the ventilator uses this data as the basis for some calculations and mode control settings. By default, neonatal weight is set to 2 kg.

To set up the patient, see Section 6.1.1.

6.5 Alarms for neonatal ventilation

Note that the following adjustable alarms use patient **Weight** to set the initial alarm limits:

- Tidal volume, high and low (Vt)
- Minute volume, high and low (ExpMinVol)

Be sure to set the correct patient **Weight** in the **Standby** window before starting ventilation. See Section 6.1.1.

6.6 O₂ enrichment for neonates

The applied oxygen concentration during the enrichment maneuver is increased to 125% of the current **Oxygen** setting.

For additional details on performing O₂ enrichment, see Chapter 10.

7

Ventilation modes

7.1	Overview.....	124
7.2	Volume-controlled modes, flow control.....	129
7.3	Volume-targeted modes, adaptive pressure control	132
7.4	Pressure-controlled modes	135
7.5	Intelligent Ventilation	142
7.6	Noninvasive modes	145
7.7	Special conditions	150
7.8	Working with noninvasive modes.....	152
7.9	Working with ASV	156

7.1 Overview

The HAMILTON-C6 offers a full range of ventilation modes that provide full and partial ventilatory support.

The primary aims of mechanical ventilation are:

- Elimination of CO₂
- Oxygenation
- Decreased work of breathing
- Patient synchronization

The detailed mode descriptions provided in this chapter illustrate how the controls work to achieve these goals.

7.1.1 Breath types and timing options

Hamilton Medical ventilators support two main breathing methods: mandatory breaths and spontaneous breaths.

Mandatory breaths. The start of inspiration (triggering) is determined by the ventilator or the patient. The end of inspiration (cycling) is determined by the ventilator.

Spontaneous breaths. The start of inspiration (triggering) and end of inspiration (cycling) is determined by the patient. The patient breathes independently or receives support from the ventilator.

The ventilator controls mandatory breath timing using a combination of inspiratory time (TI) and **Rate**.

For some modes, you can set the ventilator to use any of the following combinations to control breath timing: **I:E/Pause**, **TI/Pause**, or **Peak flow/Tip**.

Table 7-1 describes which timing philosophy is applied for the selected ventilation mode.

Table 7-1. Timing philosophy

Mode	I:E/ Pause	TI/ Pause	Peak flow/ Tip
(S)CMV, SIMV	I:E	TI	Peak flow
APVcmv, APVsimv, PCV+, PSIMV+, NIV-ST, nCPAP-PS	I:E	TI	TI
DuoPAP, APRV	T high	T high	T high

To select the breath timing to use, see Section 14.4.1.

Figure 7-1. Breath timing parameters

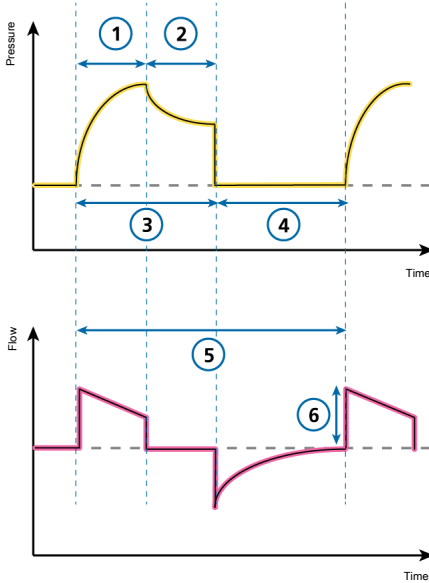

- | | |
|----------------|-------------|
| 1 TI | 4 I:E ratio |
| 2 Pause or Tip | 5 Rate |
| 3 I:E ratio | 6 Peak flow |

Note that in the breath patterns shown in this chapter, we show I:E. What is actually displayed on your device depends on the breath timing selection on the ventilator.

7.1.2 Ventilation modes

The choice of mode is a medical decision that depends on the patient's CO₂ elimination, oxygenation, activity, and breathing effort.

A ventilation mode combines breath type, breath sequence, and control variables.

The following tables provide an overview of the available ventilation modes.

Table 7-2. HAMILTON-C6 ventilation modes, description and applicable patient group

Mode name	Patient group	Mode
Volume-controlled modes, flow controlled		
(S)CMV	Adult/Ped	Breaths are volume controlled and mandatory, including patient-triggered breaths.
SIMV	Adult/Ped	Volume-controlled mandatory breaths can be alternated with pressure-supported spontaneous breaths.
Volume-targeted modes, adaptive pressure controlled		
APVcmv / (S)CMV+	All	Breaths are volume targeted and mandatory.
APVsimv / SIMV+	All	Volume-targeted mandatory breaths can be alternated with pressure-supported spontaneous breaths.
Pressure-controlled modes		
PCV+	All	All breaths, whether triggered by the patient or the ventilator, are pressure controlled and mandatory.
PSIMV+	All	Mandatory breaths are pressure controlled. Mandatory breaths can be alternated with pressure-supported spontaneous breaths.
DuoPAP	All	Mandatory breaths are pressure controlled. Spontaneous breaths can be triggered at both pressure levels.
APRV	All	Spontaneous breaths can be continuously triggered. The pressure release between the levels contributes to ventilation.
SPONT	All	Every breath is spontaneous, with or without pressure-supported spontaneous breaths.
Intelligent ventilation		
ASV	Adult/Ped	Operator sets %MinVol, PEEP, and Oxygen. Frequency, tidal volume, pressure, and I:E ratio are based on physiological input from the patient.
INTELLiVENT-ASV	Adult/Ped	Ventilator management of CO ₂ elimination and oxygenation based on clinician defined target ranges and parameter limits, and physiological input from the patient. The underlying mode is ASV.

Mode name	Patient group	Mode
Noninvasive modes		
NIV	All	Every breath is spontaneous.
NIV-ST	All	Every breath is spontaneous as long as the patient is breathing above the set rate. A backup rate can be set for mandatory breaths.
nCPAP-PS	Neonatal	Every breath is spontaneous as long as the patient is breathing above the set rate. A backup rate can be set for mandatory breaths.
HiFlowO2	All	High flow oxygen therapy. No supported breaths.

Mode type	Intelligent Ventilation		Vol. targeted, adaptive press. control		Volume controlled		Pressure controlled							Noninvasive			
	ASV***	INTELLIVENT-ASV***	APV _{vm}	APV _{aim}	(S)CMV _{vm}	SIMV _{vm}	PCV+	PSIMV+ +PSync	PSIMV+	DuoPAP	APRV	SPONT	NIV	NIV-ST	nCPAP- PG**	HiFlow O2	
Mode	--	--	Rate	Rate	Rate	Rate	Rate	Rate	Rate	Rate	T low	--	--	Rate	Rate	--	
Timing	--	--	*	*	*	*	*	*	T high	T high	--	--	--	*	*	--	
Mandatory breaths	--	--	Vt	Vt	Vt	Vt	ΔPcontrol	ΔPcontrol	P high	P high	--	--	--	ΔPinsp	ΔPinsp	--	
Spontaneous breaths	--	--	--	ΔPsupport	--	ΔPsupport	ΔPcontrol	ΔPinsp	ΔPsupport	ΔPsupport	--	ΔPsupport	ΔPsupport	ΔPinsp	ΔPinsp	--	
	Expiratory trigger	Expiratory trigger	--	Expiratory trigger	--	Expiratory trigger	--	Expiratory trigger	Expiratory trigger	Expiratory trigger	--	Expiratory trigger	Expiratory trigger	Expiratory trigger	ETS	--	
	--	--	--	--	--	--	--	--	--	--	--	Ti max	Ti max	Ti max	Ti max	--	
Baseline press. PEEP/CPAP	X	AUTO	X	X	X	X	X	X	X	P low	X	X	X	X	X	--	
Trigger	X	X	X	X	X	X	X	X	X	X	X	X	X	X	X	--	
P-ramp	X	X	X	X	--	X	X	X	X	X	X	X	X	X	X	--	
Oxygen	X	AUTO	X	X	X	X	X	X	X	X	X	X	X	X	X	X	
Sea^{***}	X	X	X	X	X	X	X	X	X	X	X	X	X	X	--	X	
Pat. height^{***}	X	X	X	X	X	X	X	X	X	X	X	X	X	X	--	X	
Mode specific	%MinVol	AUTO %MinVol	--	--	Flow pattern	Flow pattern	--	--	--	--	--	--	--	--	--	Flow	
	Plimit	Plimit	Plimit	Plimit	Pause	Plimit	Plimit	Plimit	Plimit	Plimit	Plimit	Plimit	Plimit	Plimit	Plimit	--	
Sigh^{***}	X	X	X	X	X	X	X	X	--	--	X	X	X	X	--	--	
Apnea backup	--	--	--	APV _{aim}	--	(S)CMV	--	--	APV _{aim}	APV _{aim}	APV _{aim}	APV _{aim}	PCV+	APV _{aim}	APV _{aim}	--	

* I:EI/Pause, TI/Pause, or Peak flow/Tp ** Neonatal only *** Adult/Ped only -- N/A X applies to this mode

7.2 Volume-controlled modes, flow control

The following modes are volume controlled, with flow control:

- (S)CMV
- SIMV

7.2.1 (S)CMV mode

(S)CMV stands for *synchronized controlled mandatory ventilation*.

Breaths in (S)CMV mode are volume-controlled and mandatory.

The breath can be triggered by the ventilator or by the patient. If the breath is spontaneous (triggered by the patient), the inspiratory rate may increase.

If a breath is not triggered by patient effort within a preset time, the ventilator delivers a set tidal volume with a constant flow or operator-selected flow pattern for a set inspiratory time at a set respiratory rate.

The ventilator always delivers the set tidal volume; pressure in the airway can increase or decrease depending on the resistance and compliance of the patient's lungs.

To protect the patient's lungs it is important to carefully set an upper pressure limit.

- The tidal volume (V_t) setting defines the delivered volume.
- The Rate and I:E define the timing of the breath cycle.
- The Pause setting (in %) is always set in relation to the total breath time.

Figure 7-2. (S)CMV mode: Breathing pattern and controls

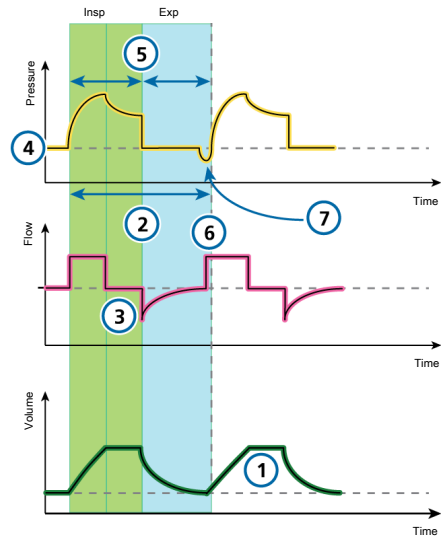

Ventilator controls

CO₂ elimination

- | | |
|---------|------------------|
| 1 V_t | 3 Pause |
| 2 Rate | Sigh (not shown) |

Oxygenation

- | | |
|---------------------|--------------------|
| 4 PEEP | 6 Flow pattern |
| 5 I:E ³³ | Oxygen (not shown) |

Patient synchronization

- | |
|-----------|
| 7 Trigger |
|-----------|

³³ Depending on the selected breath timing philosophy.

7.2.2 SIMV mode

SIMV stands for *synchronized intermittent mandatory ventilation*.

The **SIMV** mode combines attributes of the (S)CMV and SPONT modes, delivering volume-controlled mandatory breaths or pressure-supported spontaneous (patient-triggered) breaths.

SIMV mode ensures that the set target volume is delivered during the mandatory breaths. After the mandatory breath is delivered, the patient is free to take any number of spontaneous breaths for the remainder of the **SIMV** breath interval.

Each **SIMV** breath interval includes mandatory time (**Tmand**) and spontaneous time (**Tspont**).

If the patient triggers a breath during **Tmand**, the ventilator immediately delivers a mandatory breath. If the patient triggers a breath during **Tspont**, the ventilator delivers a spontaneous, pressure-supported breath.

If the patient does not trigger a breath during **Tspont**, the ventilator automatically delivers a mandatory breath at the end of **Tmand**.

In **SIMV** mode, parameters for both the mandatory and spontaneous breath types are set.

- The tidal volume (**Vt**) setting defines the delivered volume of mandatory breaths.
- **Rate** and **I:E** define the timing of the breath cycle.
- **ΔPsupport** defines the pressure support above **PEEP**. For spontaneous breaths, the expiratory trigger sensitivity (**ETS**) setting defines the percentage of peak flow that cycles the ventilator into exhalation.

Figure 7-3. SIMV mode: Breathing pattern and controls

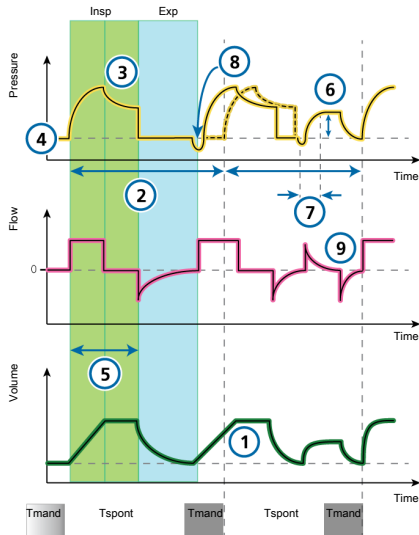

Ventilator controls

CO₂ elimination

- | | |
|------------------|---------------------------|
| 1 V _t | 3 Pause |
| 2 Rate | Sigh (<i>not shown</i>) |

Oxygenation

- | | |
|---------------------|-----------------------------------|
| 4 PEEP | 6 $\Delta P_{\text{support}}$ |
| 5 I:E ³⁴ | Oxygen (<i>not shown</i>) |
| | Flow pattern (<i>not shown</i>) |

Patient synchronization

- | | |
|-----------|-------|
| 7 P-ramp | 9 ETS |
| 8 Trigger | |

³⁴ Depending on the selected breath timing philosophy.

7.3 Volume-targeted modes, adaptive pressure control

The following modes are volume targeted, with adaptive pressure control:

- APVcmv / (S)CMV+
- APVsimv / SIMV+

In this manual, we refer to these modes using the APVcmv / APVsimv nomenclature. You can select the format to use in Configuration (Section 14.4.2).

NOTICE

- The minimum inspiratory pressure ($P_{\text{peak}} - \text{PEEP}$) in APVcmv and APVsimv modes is 5 cmH₂O. Be aware that a small set tidal volume with high lung compliance may lead to higher-than-expected tidal volumes.
- For adaptive modes, such as APVcmv or APVsimv, be sure that P_{limit} is set appropriately. This setting provides a safety pressure limit for the device to appropriately adjust the inspiratory pressure necessary to achieve the target tidal volume.

The maximum available inspiratory pressure (P_{limit}), is indicated by a blue line on the pressure waveform display.

If P_{limit} is set too low, there may not be enough margin for the device to adjust its inspiratory pressure to deliver the target tidal volume.

7.3.1 APVcmv / (S)CMV+ mode

APVcmv stands for *adaptive pressure ventilation with controlled mandatory ventilation*. This mode is also called (S)CMV+, which stands for *synchronized controlled mandatory ventilation*.

APVcmv is a volume-targeted pressure-controlled ventilation mode. It functions similarly to the conventional volume-controlled mode of ventilation, (S)CMV, except that pressure is the control variable rather than flow. Pressure is adjusted between breaths to achieve the target tidal volume.

The breath can be triggered by the ventilator or by the patient. If the breath is triggered by the patient, the inspiratory rate may increase.

The ventilator uses the P_{limit} setting (high Pressure alarm limit minus 10 cmH₂O) as a safety boundary for its inspiratory pressure adjustment, and does not exceed this value. An exception is Sigh breaths, when the ventilator may apply inspiratory pressures 3 cmH₂O below the high Pressure alarm limit.

Breaths in APVcmv mode are volume-targeted and mandatory, delivered at the lowest possible pressure depending on lung conditions.

The operator sets the target tidal volume (V_t).

The ventilator delivers the set target volume (V_t) at a preset rate. The patient can trigger mandatory breaths between preset rate breaths.

Figure 7-4. APVcmv / (S)CMV+: Breathing pattern and controls

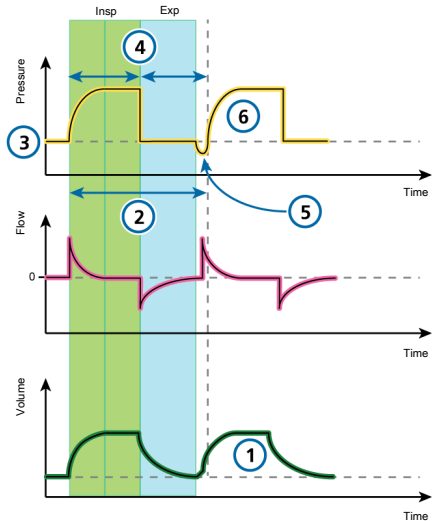

Ventilator controls

CO₂ elimination

- 1 V_t 2 Rate
- Sigh (not shown)

Oxygenation

- 3 PEEP 4 I:E³⁵
- Oxygen (not shown)

Patient synchronization

- 5 Trigger 6 P-ramp

³⁵ Depending on the selected breath timing philosophy.

7.3.2 APVsimv / SIMV+ mode

APVsimv stands for *adaptive pressure ventilation with synchronized intermittent mandatory ventilation*. This mode is also called SIMV+, *synchronized intermittent mandatory ventilation plus*.

The APVsimv mode combines attributes of the APVcmv and SPONT modes, delivering volume-targeted mandatory breaths or pressure-supported spontaneous (patient-triggered) breaths.

APVsimv mode ensures that the set target volume is delivered during the mandatory breaths.

After the mandatory breath is delivered, the patient is free to take any number of spontaneous breaths for the remainder of the APV breath interval.

The ventilator uses the Plimit setting (high Pressure alarm limit minus 10 cmH₂O) as a safety boundary for its inspiratory pressure adjustment, and does not exceed this value. An exception is Sigh breaths, when the ventilator may apply inspiratory pressures 3 cmH₂O below the high Pressure alarm limit.

Each breath interval includes mandatory time (T_{mand}) and spontaneous time (T_{spont}).

- If the patient triggers a breath during T_{mand}, the ventilator immediately delivers a mandatory breath.
- If the patient triggers a breath during T_{spont}, the ventilator delivers a spontaneous pressure-supported breath.

If the patient does not trigger a breath during T_{spont}, the ventilator automatically delivers a mandatory breath at the end of T_{mand}.

In this mode, parameters for both mandatory and spontaneous breath types are set.

- The tidal volume (V_t) setting defines the delivered volume of mandatory breaths.
- Rate and I:E define the timing of the breath cycle for mandatory breaths.
- For spontaneous breaths, ΔP_{support} defines the pressure support above PEEP.
- ETS defines the inspiratory timing of the breaths.

The inspiratory time can also be limited by TI max.³⁶

³⁶ TI max is only available for adult/pediatric patients if it is enabled in Configuration (Section 14.4.4). It is always available for neonates.

Figure 7-5. APVsimv / SIMV+: Breathing pattern and controls

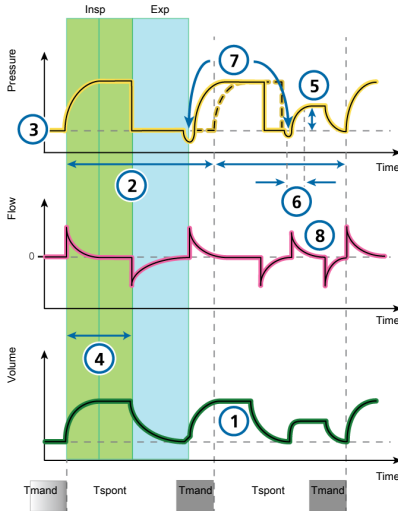

7.4 Pressure-controlled modes

The following modes are pressure controlled:

- PCV+
- PSIMV+
- PSIMV+ with PSync
- DuoPAP
- APRV
- SPONT

Ventilator controls

CO₂ elimination

- | | |
|------------------|--------|
| 1 Vt | 2 Rate |
| Sigh (not shown) | |

Oxygenation

- | | |
|---------------------|-------------------------------|
| 3 PEEP | 5 $\Delta P_{\text{support}}$ |
| 4 I:E ³⁷ | Oxygen (not shown) |

Patient synchronization

- | | |
|-----------|-------|
| 6 P-ramp | 8 ETS |
| 7 Trigger | |

³⁷ Depending on the selected breath timing philosophy.

7.4.1 PCV+ mode

PCV+ stands for *pressure-controlled ventilation*.

Breaths in PCV+ mode are pressure controlled and mandatory.

The ventilator delivers a constant level of pressure, so the volume depends on the pressure settings, the inspiration time, and the resistance and compliance of the patient's lungs.

In PCV+ mode, parameters are set only for mandatory breaths.

- The pressure control ($\Delta P_{control}$) setting defines the applied pressure above PEEP.
- Rate and I:E define the timing of the breath cycle.
- The P-ramp setting controls the speed with which the ventilator arrives at the desired pressure.

Figure 7-6. PCV+ mode: Breathing pattern and controls

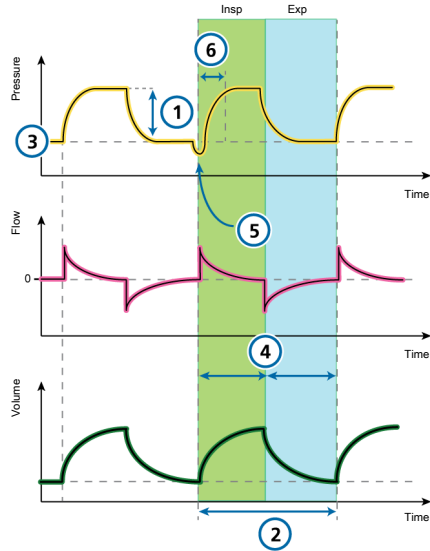

Ventilator controls

CO2 elimination

- | | |
|------------------------|--------|
| 1 $\Delta P_{control}$ | 2 Rate |
|------------------------|--------|
- Sigh (not shown)

Oxygenation

- | | |
|--------|---------------------|
| 3 PEEP | 4 I:E ³⁸ |
|--------|---------------------|
- Oxygen (not shown)

Patient synchronization

- | | |
|-----------|----------|
| 5 Trigger | 6 P-ramp |
|-----------|----------|

³⁸ Depending on the selected breath timing philosophy.

7.4.2 PSIMV+ mode

PSIMV+ stands for *pressure-controlled synchronized intermittent mandatory ventilation*.

PSIMV+ mode has two options: with and without PSync. For a description of PSIMV+ with active PSync, see Section 7.4.3.

In PSIMV+ mode, the mandatory breaths are PCV+ breaths. These can be alternated with spontaneous breaths.

Each SIMV breath interval includes mandatory time (Tmand) and spontaneous time (Tspont).

- If the patient triggers a breath during Tmand, the ventilator immediately delivers a mandatory breath.
- If the patient triggers a breath during Tspont, the ventilator delivers a spontaneous, pressure-supported breath.
- If the patient does not trigger a breath during Tspont, the ventilator automatically delivers a mandatory breath at the end of Tmand.

In PSIMV+ mode, parameters for both mandatory and spontaneous breath types are set.

- For mandatory breaths, the pressure control ($\Delta P_{control}$) setting defines the applied pressure above PEEP. Rate and I:E define the timing of the breath cycle.
- For spontaneous breaths, $\Delta P_{support}$ defines the pressure support above PEEP.

- ETS defines the inspiratory timing of the breaths. The inspiratory time can also be limited by TI max.³⁹

Figure 7-7. PSIMV+ mode: Breathing pattern and controls

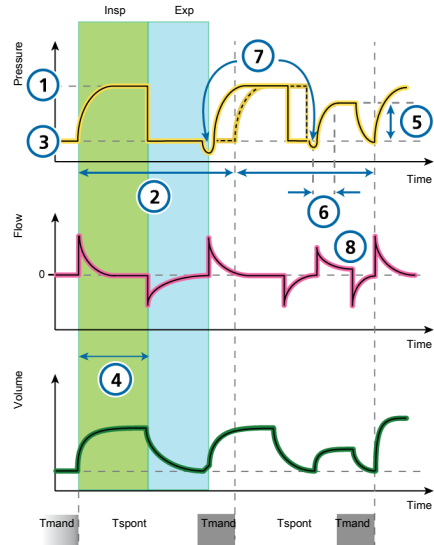

Ventilator controls

CO2 elimination

- | | |
|------------------------|--------|
| 1 $\Delta P_{control}$ | 2 Rate |
| Sigh (not shown) | |

Oxygenation

- | | |
|---------------------|------------------------|
| 3 PEEP | 5 $\Delta P_{support}$ |
| 4 I:E ⁴⁰ | Oxygen (not shown) |

Patient synchronization

- | | |
|-----------|-------|
| 6 P-ramp | 8 ETS |
| 7 Trigger | |

³⁹ TI max is only available for adult/pediatric patients if it is enabled in Configuration (Section 14.4.4). It is always available for neonates.

⁴⁰ Depending on the selected breath timing philosophy.

7.4.3 PSIMV+ mode with PSync

PSIMV+ stands for *pressure-controlled synchronized intermittent mandatory ventilation*.

PSIMV+ mode has two options: with and without PSync. For a description of PSIMV+ without active PSync, see Section 7.4.2.

If the patient triggers a breath, the ventilator delivers a breath supported at the ΔP_{insp} setting.

If the patient does not trigger a breath, the ventilator automatically delivers a mandatory breath at the ΔP_{insp} setting.

In PSIMV+ mode, parameters for both mandatory and spontaneous breath types are set.

- The ΔP_{insp} setting defines the applied pressure above PEEP for mandatory and spontaneous breaths.
- Rate and TI define the breath timing for mandatory breaths.
- For spontaneous breaths, ETS defines the inspiratory timing of the breaths. The inspiratory time can also be limited by TI max.⁴¹

Figure 7-8. PSIMV+ with PSync mode: Breathing pattern and controls

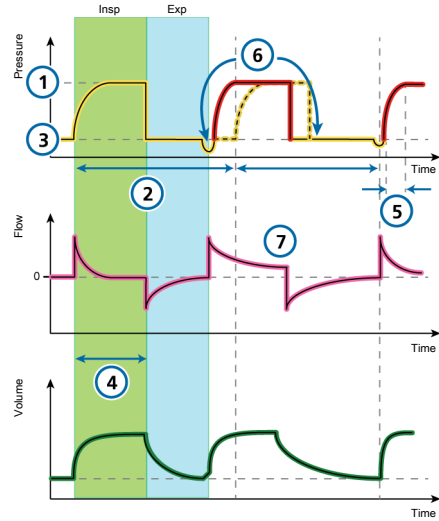

Ventilator controls

CO2 elimination

- | | |
|----------------------------|--------|
| 1 ΔP_{insp} | 2 Rate |
|----------------------------|--------|

Sigh (not shown)

Oxygenation

- | | |
|--------|---------------------|
| 3 PEEP | 4 I:E ⁴² |
|--------|---------------------|

Oxygen (not shown)

Patient synchronization

- | | |
|----------|-------|
| 5 P-ramp | 7 ETS |
|----------|-------|

- | |
|-----------|
| 6 Trigger |
|-----------|

⁴¹ TI max is only available for adult/pediatric patients if it is enabled in Configuration (Section 14.4.4). It is always available for neonates.

⁴² Depending on the selected breath timing philosophy.

7.4.4 DuoPAP mode

DuoPAP stands for *duo positive airway pressure*.

DuoPAP is a type of pressure ventilation designed to support spontaneous breathing on two alternating levels of CPAP.

In this mode, the ventilator switches automatically and regularly between two operator-selected levels of positive airway pressure or CPAP.

Cycling between the levels is triggered by DuoPAP timing settings or by patient effort.

In DuoPAP, the switch-over between the two levels is defined by the pressure settings, P high and PEEP/CPAP, and the time settings, T high and Rate.

Note the following:

- At conventional settings and in the absence of spontaneous breathing, DuoPAP resembles PCV+.
- As you decrease the rate, keeping T high short relative to the time at the lower pressure level, the mode looks more like PSIMV+, with spontaneous breaths following mandatory breaths.
- If T high is set to almost the breath cycle time with just enough time at the low level to allow full or near-full exhalation, this mode looks like APRV (Section 7.4.5).

Pressure support can be set to assist spontaneous breaths in DuoPAP, whether they occur at the PEEP/CPAP or P high level.

$\Delta P_{\text{support}}$ is set relative to (above) PEEP/CPAP, which means that spontaneous breaths at the P high level are supported only when this target pressure is greater than P high.

Figure 7-9. DuoPAP mode: Breathing pattern and controls

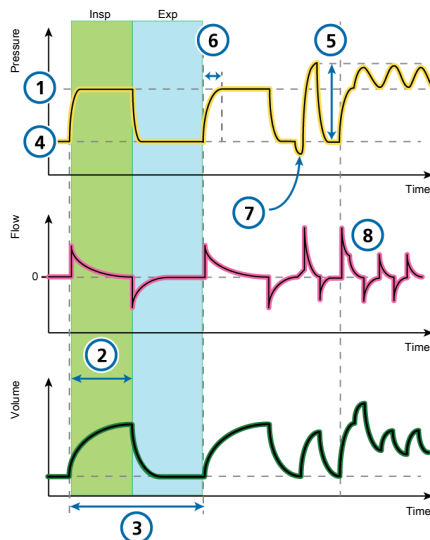

Ventilator controls

CO2 elimination

- | | |
|----------|--------|
| 1 P high | 3 Rate |
| 2 T high | |

Oxygenation

- | | |
|-------------|-------------------------------|
| 4 PEEP/CPAP | 5 $\Delta P_{\text{support}}$ |
|-------------|-------------------------------|
- Oxygen (not shown)

Patient synchronization

- | | |
|---|-------|
| 6 P-rampFN-Pramp-rise-time-to-Phigh-and-Psupport-C3-C6-G5-SR1 | 8 ETS |
| 7 Trigger ⁴³ | |

⁴³ Only used to count spontaneous breaths or to monitor patient activity.

7.4.5 APRV mode

APRV stands for *airway pressure release ventilation*.

Set airway pressure P high is transiently released to a lower level P low, after which it is quickly restored to reinflate the lungs.

For a patient who has no spontaneous breathing efforts, APRV is similar to pressure-controlled inverse ratio ventilation.

APRV allows spontaneous breathing at any time during the respiratory cycle.

APRV is an independent mode. When changing modes, the pressure and timing settings from any other mode are not transferred to APRV, and vice versa.

When switching to APRV for the first time, the initial timing and pressure settings proposed are based on IBW (Weight for neonatal patients) as shown in the following table.

Table 7-3. Default settings for APRV

IBW / Weight (kg)	P high / P low (cmH2O)	T high (s)	T low (s)
0.2 to 2.99	20 / 5	1.4	0.2
3 to 5.9	20 / 5	1.7	0.3
6 to 8.9	20 / 5	2.1	0.3
9 to 20.9	20 / 5	2.6	0.4
21 to 39	20 / 5	3.5	0.5
40 to 59	20 / 5	4.4	0.6
> 60	20 / 5	5.4	0.6

Figure 7-10. APRV mode: Breathing pattern and controls

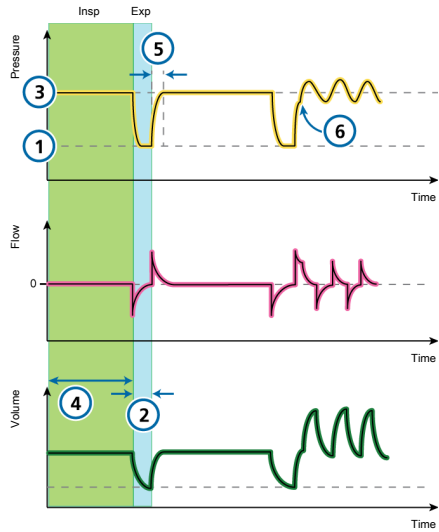

Ventilator controls

CO2 elimination

- 1 P low
- 2 T low

Oxygenation

- 3 P high⁴⁴
- 4 T high

Oxygen (*not shown*)

Patient synchronization

- 5 P-ramp (to P high)
- 6 Trigger⁴⁵

⁴⁴ With prolonged T high settings and short T low settings, the P high setting in effect becomes the PEEP level.

⁴⁵ Only used to count spontaneous breaths or to monitor patient activity.

7.4.6 SPONT mode

SPONT stands for *spontaneous mode*.

SPONT delivers spontaneous breaths and operator-initiated manual, mandatory breaths.

When pressure support is set to zero, the ventilator functions like a conventional CPAP system.

- The pressure support ($\Delta P_{\text{support}}$) setting defines the applied pressure during inspiration.
- The PEEP setting defines the PEEP applied during expiration.
- ETS defines the inspiratory timing of the breaths.

The inspiratory time can also be limited by TI max.⁴⁶

Figure 7-11. SPONT mode: Breathing pattern and controls

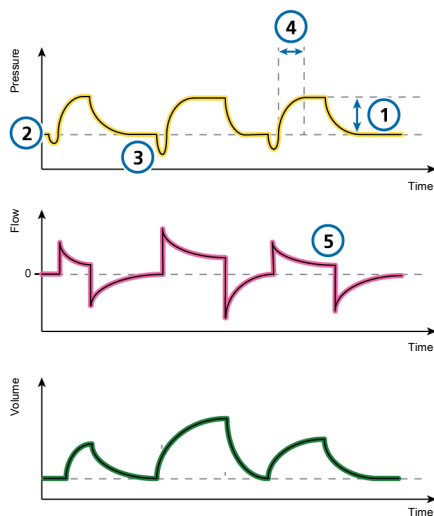

Ventilator controls

CO₂ elimination

1 $\Delta P_{\text{support}}$ Sigh (*not shown*)

Oxygenation

2 PEEP Oxygen (*not shown*)

Patient synchronization

3 Trigger 5 ETS

4 P-ramp

⁴⁶ TI max is only available for adult/pediatric patients if it is enabled in Configuration (Section 14.4.4). It is always available for neonates.

7.5 Intelligent Ventilation

The following are adaptive pressure-controlled, volume-targeted Intelligent Ventilation modes:

- ASV®
- INTELLiVENT®-ASV®

ASV and INTELLiVENT-ASV are *not* available for neonatal patients.

7.5.1 ASV mode

ASV stands for *Adaptive Support Ventilation*®.

ASV maintains an operator-preset, minimum minute ventilation independent of the patient's breathing activity.

The target breathing pattern (tidal volume and respiratory rate) is calculated by the ventilator, based on the assumption that the optimal breathing pattern results in the least work of breathing, and the minimal force of breathing (driving pressure). For initial settings, see Table 7-4.

ASV adjusts inspiratory pressure and mandatory rate on a breath-by-breath basis taking into account the changing patient lung mechanics (resistance, compliance, RCexp) and applying lung-protective strategies to meet the targets.

A decrease in pressure limitation (Plimit) will follow with a decrease in tidal volume (Vt) and an increase in Rate.

Figure 7-12. ASV mode: Breathing pattern and controls

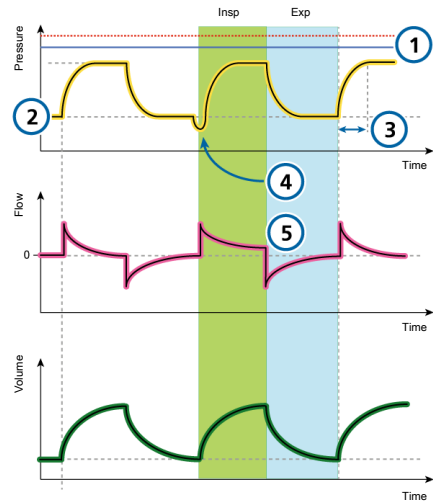

Ventilator controls

CO2 elimination

- | | | |
|---|---------|------------------|
| 1 | Plimit | Sigh (not shown) |
| | %MinVol | (not shown) |

Oxygenation

- | | | |
|---|-----------|--------------------|
| 2 | PEEP/CPAP | Oxygen (not shown) |
|---|-----------|--------------------|

Patient synchronization

- | | | | |
|---|---------|---|-----|
| 3 | P-ramp | 5 | ETS |
| 4 | Trigger | | |

ASV maintains a **preset minimum minute ventilation**:

- Automatically adjusts for changing patient conditions between active and passive states
- Mandatory breaths are pressure controlled
- Spontaneous breaths are pressure supported
- Prevents tachypnea

- Prevents AutoPEEP
- Prevents dead space ventilation
- Does not exceed a ΔP_{insp} pressure of **10 cmH₂O below the upper pressure limit**

The operator sets the %MinVol, PEEP, and Oxygen.

For details about working with ASV, see Section 7.9.

Table 7-4. ASV mode initial breath pattern settings

Patient group	IBW (kg)	ΔP_{insp} (cmH ₂ O)	TI (s)	Initial rate (b/min)
Pediatric	3 to 5	15	0.4	30
	6 to 8	15	0.6	25
	9 to 11	15	0.6	25
	12 to 14	15	0.7	20
	15 to 20	15	0.8	20
	21 to 23	15	0.9	20
	24 to 29	15	1	20
	> 30	15	1	20
Adult	10 to 29	15	1	20
	30 to 39	15	1	18
	40 to 59	15	1	15
	60 to 89	15	1	15
	90 to 99	18	1.5	15
	> 100	20	1.5	15

7.5.1.1 ASV and ASV 1.1

ASV 1.1 is the default setting for the ASV mode. The previous version of ASV is also available on the device, and can be selected in **Configuration**.

ASV 1.1 follows the low tidal volume recommendation (Bellani G, et al. JAMA 2016) and brings additional features and changes:

- Increased target rate and reduced tidal volumes and driving pressure for the majority of patients compared to standard ASV.
- In cases of high time constants and high minute volumes, V_t max is limited to 15 ml/kg.

For details about working with ASV, see Section 7.9.

7.5.2 INTELLiVENT-ASV mode

INTELLiVENT-ASV is available as an option⁴⁷ on the HAMILTON-C6 for adult and pediatric patients.

INTELLiVENT-ASV is an advanced ventilation mode, based on the proven Adaptive Support Ventilation (ASV) mode, to automatically regulate CO₂ elimination and oxygenation for both passive and active patients, based on both physiologic data from the patient and clinician-set targets.

With this mode, the clinician sets targets for PetCO₂ and SpO₂ for the patient.

INTELLiVENT-ASV then automates management of the controls for CO₂ elimination (%MinVol), and oxygenation (PEEP and Oxygen) based on these targets and on the physiologic input from the patient (PetCO₂ and SpO₂).

INTELLiVENT-ASV continuously monitors patient conditions and automatically and safely adjusts parameters to keep the patient within target ranges, with minimal clinician interaction, from intubation to extubation.

For operation details, see the *INTELLiVENT-ASV Operator's Manual*.

⁴⁷ Not available in all markets, including the USA.

7.6 Noninvasive modes

The following modes are noninvasive:

- NIV
- NIV-ST
- nCPAP-PS
- HiFlowO2

The NIV and NIV-ST modes are implementations of noninvasive positive pressure ventilation (NPPV).

nCPAP-PS is a neonatal mode that offers nasal continuous positive airway pressure - and intermittent positive pressure support through a nasal interface (mask or prongs) for infants and neonates.

HiFlowO2 is a mode that delivers a continuous air/gas mixture to the patient via a nasal interface.

For details about working with noninvasive modes, see Section 7.8.

CAUTION

- *Hamilton Medical ventilators must not be used for helmet CPAP therapy.*
- *All Hamilton Medical ventilators are able to provide noninvasive ventilation through a helmet. The turbine-driven ventilators are able to provide higher continuous flow levels, and the air supply provided by filtered room air (HEPA) with ambient humidity.*

7.6.1 NIV mode

NIV stands for *noninvasive ventilation*.

NIV mode delivers spontaneous breaths.

NIV is designed for use with a mask or other noninvasive patient interface.

When pressure support is set to zero, the ventilator functions like a conventional CPAP system.

- The pressure support ($\Delta P_{\text{support}}$) setting defines the applied pressure during inspiration.
- ETS defines the inspiratory timing of the breaths.
The inspiratory time can also be limited by TI max.
- The PEEP setting defines the PEEP applied during expiration.

For additional details about working with noninvasive modes, see Section 7.8.

Figure 7-13. NIV mode: Breathing pattern and controls

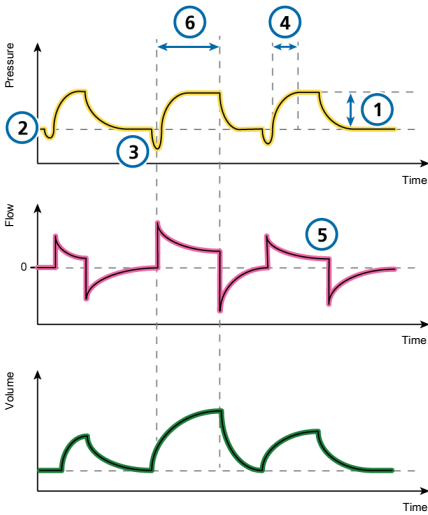

Ventilator controls

CO2 elimination

1 $\Delta P_{support}$ Sigh (not shown)

Oxygenation

2 PEEP Oxygen (not shown)

Patient synchronization

3 Trigger 5 ETS

4 P-ramp 6 TI max

7.6.2 NIV-ST mode

NIV-ST stands for *spontaneous/timed noninvasive ventilation*.

NIV-ST mode delivers time-cycled or flow-cycled breaths. Every patient trigger results in a flow-cycled, pressure-supported breath.

If the rate of patient-triggered breaths falls below the set mandatory Rate, time-cycled breaths are delivered at the set Rate and timing.

If the patient triggers a breath during the current breath interval, the ventilator immediately delivers a spontaneous breath. If the patient does not trigger an inspiration during this time, the ventilator initiates a mandatory breath according to the set Rate.

This mode requires that you set the parameters needed for both mandatory and spontaneous breath types.

- The inspiratory pressure setting, ΔP_{insp} , defines the applied pressure for both mandatory and spontaneous breaths.
- The Rate and TI (inspiratory time) control settings define the breath timing.
- For spontaneous breaths, the ETS setting defines the percentage of peak flow that cycles the device into exhalation.

If the ventilator does not detect an expiratory trigger (for example, due to a leak), inspiratory time is limited by TI max.

Figure 7-14. NIV-ST mode: Breathing pattern and controls

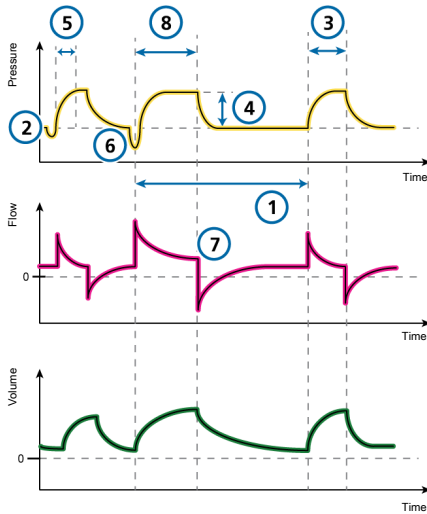

Ventilator controls

CO2 elimination

1 Rate Sigh (not shown)

Oxygenation

2 PEEP 3 TI

Oxygen (not shown)

Patient synchronization

4 ΔP_{insp} 7 ETS

5 P-ramp 8 TI max

6 Trigger

7.6.3 nCPAP-PS mode

nCPAP-PS stands for *nasal continuous positive airway pressure*.

nCPAP-PS is a neonatal mode that offers nasal continuous positive airway pressure and intermittent positive pressure support through a nasal interface (mask or prongs) for infants and neonates. It is designed to apply CPAP using a nasal interface (mask or prongs).

When P_{insp} is set to zero, the ventilator functions like a conventional nCPAP system.

If the patient triggers a breath during the current breath interval, the ventilator immediately delivers a spontaneous breath. If the patient does not trigger an inspiration during this time, the ventilator initiates a mandatory breath according to the set Rate.

This mode requires that you set the parameters needed for both mandatory and spontaneous breath types.

- The inspiratory pressure setting, ΔP_{insp} , defines the applied pressure for both mandatory and spontaneous breaths.
- The Rate and TI (inspiratory time) control settings define the breath timing.
- For spontaneous breaths, the ETS setting defines the percentage of peak flow that cycles the device into exhalation.

If the ventilator does not detect an expiratory trigger (for example, due to a leak), inspiratory time is limited by TI max.

- The TI max setting provides an alternative: when inspiration lasts longer than TI max, the ventilator cycles into exhalation.

Note that volume is *not* monitored in this mode.

Figure 7-15. nCPAP-PS mode: Breathing pattern and controls

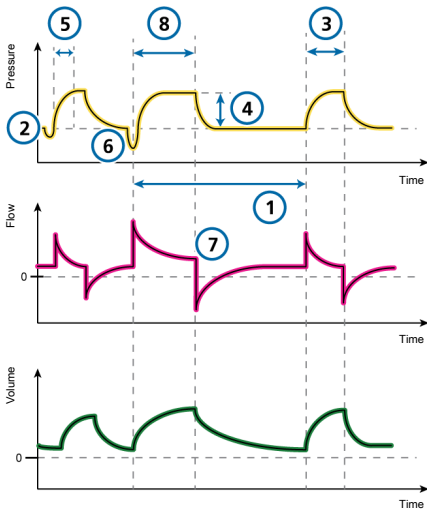

Ventilator controls

CO2 elimination

1 Rate

Oxygenation

2 PEEP 3 TI

Oxygen (*not shown*)

Patient synchronization

4 ΔPinsp 7 ETS

5 P-ramp 8 TI max

6 Trigger

7.6.4 High flow oxygen therapy

High flow oxygen (HiFlowO2⁴⁸) is indicated for adult, pediatric, and neonatal patients who are able to inhale and exhale spontaneously.

HiFlowO2 is an optional therapy in which a continuous flow of heated and humidified respiratory gases are delivered to the patient. An operating humidifier is required.

The set flow can vary from 2 to 100 l/min for adult and pediatric patients, and 2 to 30 l/min for neonatal patients.⁴⁹ In Configuration, you can specify the maximum Flow that can be set in HiFlowO2 for neonatal patients. For details, see Section 14.3.7.

The operator sets the oxygen and flow rate. If a flow sensor is connected, the airway pressure (Pprox) is monitored.

Depending on the circuit and interface resistance, higher pressures may be required to deliver the set flow. Pressure is measured inside the ventilator. If pressure exceeds the high pressure limit of 45 cmH2O, the medium-priority Check for blockage alarm is generated.

If the pressure increases further and exceeds 50 cmH2O, the Check for blockage alarm becomes high priority. In this case, the gas flow stops immediately and the pressure is released. Once the pressure is released, the device restarts with the previous flow.

This respiratory support is usually delivered through a nasal cannula, with the flow exceeding the patient's peak inspiratory flow to provide inspired oxygen of up to 100%.

⁴⁸ Not available in all markets.

⁴⁹ In some markets, the maximum possible Flow setting may be limited.

High flow oxygen therapy can be delivered using single or double limb breathing circuits, using a high-flow nasal cannula or a tracheal adapter/tracheal mask to enable the patient to exhale.

Note that during high flow oxygen therapy, disconnection and apnea alarms are inactive.

7.6.4.1 Delivering high flow oxygen therapy

Note that you must be in **Standby** to change the mode.

To deliver high flow oxygen therapy

1. Set up the patient with an appropriate breathing circuit.

Figures 2-8 and 2-10 show a noninvasive circuit set.

2. Place the ventilator in **Standby**, and touch **Modes**.
3. Touch **HiFlowO2**, then touch **Confirm**.
The **Controls > Basic** window opens.
Be sure to carefully read the safety information displayed in the window:



Use only interfaces intended for high flow O2.

The use of unsuitable interfaces poses a risk to the patient.

Active humidification is mandatory.

4. Set the desired values for **Oxygen** and **Flow**, then touch **Confirm**.

You can change these settings at any time.

The **Standby** window is displayed, showing the **Start therapy** button.

5. Perform the preoperational checks, especially the **Leak** test. See Section 5.4.
6. In the **Standby** window, touch **Start therapy** to begin the oxygen therapy.
The main display changes to show the following safety information about oxygen therapy in addition to graphics and parameter values related to the therapy.



Hi Flow O2 therapy
No apnea detection!
No disconnection detection!

7.6.4.2 Parameters monitored in HiFlowO2 mode

When high flow oxygen therapy is in progress, the following parameters are monitored:

- Oxygen
- Flow (in trend and as an MMP)
- T humidifier⁵⁰
- SpO2/FiO2, SpO2, if enabled
- If a flow sensor is connected, Pprox is monitored⁵¹

The **Alarms > Limits 1** window is not available during high flow oxygen therapy.

⁵⁰ When remote access to a HAMILTON-H900 humidifier is enabled.

⁵¹ Pprox is available in the Monitoring window.

7.7 Special conditions

The following ventilator modes/states may be observed under certain error conditions:

Table 7-5. Special conditions overview

For details about ...	See ...
Sensor Failure mode	Section 7.7.1
Safety ventilation	Section 7.7.2
Ambient state	Section 7.7.3
Display and communication error states	Section 7.7.4

7.7.1 Sensor Failure mode

When there is a problem with the flow sensor that lasts for more than three breath cycles, the **External flow sensor failed** alarm is generated and the ventilator switches to **Sensor Failure** mode. Ventilation continues in **PCV+** mode.

Once the alarm is resolved, the ventilator exits **Sensor Failure** mode and returns to ventilation with the previous mode and settings.

For details about the **External flow sensor failed** alarm, see Section 9.4.

The following conditions apply to ventilation in **Sensor Failure** mode:

- The ventilator changes to **PCV+** mode.
- Internal ventilator pressure (**Pvent**) is displayed instead of airway pressure (**Paw**).
- Monitoring parameters related to the flow sensor measurement are shown in grey, indicating they are inaccurate.
- The message **Sensor Failure mode ventilation initiated** is recorded in the Event log.

7.7.2 Safety ventilation

In the event of certain technical failures, the ventilator switches to **Safety ventilation**. This gives you time to arrange for corrective actions, including organizing a replacement ventilator.

If these conditions occur when using **HiFlowO2**, the ventilator switches to **Safety mode**.

The following conditions apply to ventilation in **Safety ventilation**:

- The ventilator does not monitor patient inputs in **Safety ventilation**.
- In **Safety ventilation**, the blower runs constantly to create inspiratory pressure (**ΔP_{insp}**) (Tables 7-6 and 7-7).

In **Safety mode**, the blower creates a constant pressure of 5 cmH₂O at the inspiratory port.

- In **Safety ventilation**, the expiratory valve switches system pressure levels between **PEEP** and inspiratory pressure.
- You must turn off ventilator power to exit **Safety ventilation**.

Table 7-6. Safety ventilation settings (Adult/Ped)

IBW (kg)	ΔP_{insp} (cmH ₂ O)	Rate (b/min)	Oxygen (%)
3 to 5.9	15	35	> 21%
6 to 8.9	15	30	> 21%
9 to 19.9	15	25	> 21%
20 to 30	15	20	> 21%
31 to 39	15	17	> 21%
40 to 59	15	15	> 21%
60 to 89	15	12	> 21%
90 to 99	18	12	> 21%
≥ 100	20	12	> 21%

PEEP is set to the PEEP of the previous mode and the I:E ratio is 1:4.

Table 7-7. Safety ventilation settings (Neonatal)

Weight (kg)	ΔP_{insp} (cmH ₂ O)	Rate (b/min)	Oxygen (%)
< 1.26	15	60	> 21%
1.26 to 2.99	15	45	> 21%
3.0 to 5.9	15	35	> 21%
6.0 to 8.9	15	30	> 21%
9.0 to 19.9	15	25	> 21%
> 20	15	20	> 21%

PEEP is set to the PEEP of the previous mode and the I:E ratio is 1:3.

7.7.3 Ambient state

If the technical fault alarm is serious enough to possibly compromise safe ventilation, the ventilator enters the **Ambient state**.

The following conditions apply to ventilation in the **Ambient state**:

- The inspiratory channel and expiratory valves are opened, letting the patient breathe room air unassisted.
- Provide alternative ventilation immediately.
- You must turn off ventilator power to exit the **Ambient state**.

7.7.4 Display and communication error states

When a problem occurs either with the monitor and display or with communication between the monitor and the ventilator unit, the ventilator enters the **Display/connection error state**.

If this occurs, first check whether the cable connections between the monitor and the ventilator are well seated and secure. If the problem is not resolved, arrange for alternate ventilation and have the ventilator serviced.

The following conditions apply to ventilation in the **Display/connection error** state:

- There is a noticeable display problem, with either of the following situations:
 - The display is completely dark (not working)
 - The display does not show any data, and one of the following errors is generated: **Panel connection lost** or **Display error**.
- Immediately check the status indicators on the front of the ventilator (Section 2.2.1.1).
 - If the lung icon is green and flashing, ventilation continues.
 - **If the lung icon is dark, ventilation has stopped or has switched to the Ambient state. Provide alternative ventilation immediately!**
- Depending on the nature of the error, the buzzer sounds immediately or after a 30-second delay.
The buzzer cannot be silenced. You must turn off the ventilator to exit this state.
- Generated alarms are logged in the Event log and alarm buffer, although you might not be able to review them due to display issues.
- Arrange alternative ventilation.
- Have the ventilator serviced.

7.8 Working with noninvasive modes

This section provides an overview of noninvasive ventilation requirements, contraindications for use, and important information about settings and alarms.

When using noninvasive positive pressure ventilation (NPPV), use a noninvasive patient interface, for example a mask, rather than an invasive conduit.

7.8.1 Required conditions for use

Before proceeding, review the safety information in Chapter 1.

The following requirements **must be met** to use noninvasive ventilation:

- The patient must be able to trigger the ventilator and must have regular spontaneous breaths.
Noninvasive ventilation is intended to provide supplemental ventilatory support to patients with regular spontaneous breaths.
- The patient must be conscious.
- The patient must be able to maintain an adequate airway.
- Intubation must be possible at any time.
- The mask or interface is a good fit.

7.8.2 Contraindications

CAUTION

- *If you place an additional component, such as an HMEF, between the flow sensor and the patient, the additional resistance limits the ventilator's ability to identify disconnection at the patient.
To correctly identify a patient disconnection, be sure to appropriately set the lower limit of the Pressure alarm, as well as the Volume alarm limits, and carefully monitor the patient's SpO2 and, if available, PetCO2 values.*
- *To prevent possible patient injury, do NOT use noninvasive ventilation on patients with no or irregular spontaneous breaths. Noninvasive ventilation is intended to provide supplemental ventilatory support to patients with regular spontaneous breaths.*
- *To prevent possible patient injury, do NOT attempt to use noninvasive ventilation on intubated patients.*

Using noninvasive ventilation is contraindicated if **any** of the following conditions are met:

- The patient does not have the drive to breathe
- Partial or complete airway obstruction
- Gastrointestinal bleeding
- Anatomic or subjective intolerance of NIV interface
- Patient is unable to cooperate or protect airway

7.8.3 Potential adverse reactions

The following reactions to noninvasive ventilation are possible:

- Aspiration, gastric insufflation
- Increase of intracranial pressure (ICP)
- Decrease of arterial pressure
- CO2 rebreathing
- Claustrophobia
- Discomfort
- Dyssynchrony
- Skin or conjunctiva lesions

7.8.4 Control settings in noninvasive ventilation

WARNING

- The exhaled volume from the patient can differ from the measured exhaled volume due to leaks around the mask.
- Peak pressures exceeding 33 cmH2O may increase the risk of aspiration due to gastric insufflation. When ventilating with such pressures, consider using an invasive mode.

When a significant leak occurs, the inspiratory flow can never fall below ETS, thereby preventing the ventilator from cycling into exhalation and resulting in endless inspiration. The TI max setting provides an alternate way to cycle into exhalation. When inspiration lasts longer than TI max, the ventilator cycles into exhalation.

Ensure the **TI max** setting is sufficiently long to give **ETS** the chance to cycle the ventilator.

- Adjusting the **TI max** setting increases or decreases the allowable inspiratory time.
- Increasing **ETS** above the default 25% allows the ventilator to cycle to terminate inspiration at a higher flow, to accommodate larger leaks.

Other controls require special attention:

- Carefully observe the patient/ventilator interaction.
- Adjust $\Delta P_{\text{support}}$ or ΔP_{insp} to obtain appropriate tidal volumes.
- The leakage in noninvasive modes can reduce the actual applied **PEEP** and give rise to autotriggering.
- Adjust **PEEP** further, considering oxygenation and **AutoPEEP**.

7.8.5 Alarms in noninvasive ventilation

Due to the changing and unpredictable amount of leakage, volume alarms are less meaningful in noninvasive modes than in other modes. Alarms are based on the returned expiratory gas volume measured at the flow sensor; this value can be significantly lower than the delivered tidal volume, because the delivered tidal volume is the sum of the displayed **VTE** and the leakage volume.

To avoid nuisance volume alarms, set the low **Vt** and **ExpMinVol** alarms to a low level.

Because the noninvasive modes are pressure modes, however, do pay attention to the pressure-related alarms. If the defined **PEEP** and inspiratory pressure can be maintained, the ventilator is compensating the gas leak sufficiently.

7.8.6 Monitored parameters in noninvasive ventilation

NOTICE

- The following numeric monitoring parameters *cannot* be used for reliable analysis of patient conditions: **ExpMinVol**, **RCexp**, **Rinsp**, **Insp Flow**, **AutoPEEP**, and **Cstat**.
- Continuous monitoring of clinical parameters and patient comfort is critically important.
- The parameters **VTE NIV**, **MinVol NIV**, **MVSpont NIV**, and **MVLeak** are leak compensated, and are used in noninvasive modes. These parameters are estimations and may not reflect exact values.

Due to the leakage at the patient interface, displayed exhaled volumes in the noninvasive modes can be substantially smaller than the delivered volumes.

The flow sensor measures the delivered volume and the exhaled tidal volume; the ventilator displays the difference as **VLeak** in percent (%), and as **MVLeak** in l/min. Use **VLeak** and **MVLeak** to assess the fit of the mask or other noninvasive patient interface.

While a leak at the patient interface influences the tidal volume measurement, leaks in the breathing circuit itself do not influence the tidal volume measurement.

In addition to other clinical parameters, T_I , P_{peak} , PEEP/CPAP, I:E, f_{Total} , P_{mean} , and f_{Spont} can be used to assess the patient's ventilatory status.

7.8.7 Additional notes about using noninvasive ventilation

Due to some unique characteristics, consider the following points when using noninvasive ventilation.

IntelliTrig function

To synchronize, IntelliTrig compensates for leaks and resistance between the ventilator and the patient, and with each breath, it measures the leakage at the patient interface (mask).

With this information, IntelliTrig adjusts the trigger mechanism, reducing the influence of leakage and the changing breath pattern on the operator-set trigger sensitivity.

Maintaining PEEP and preventing auto-triggering

Significant leakage can be present in noninvasive ventilation, which can serve to reduce the actual applied PEEP/CPAP and give rise to autotriggering. If you cannot reach the set PEEP/CPAP, check the mask fit.

The **Loss of PEEP** alarm alerts you to uncompensated leaks (that is, when the measured PEEP/CPAP is 3 cmH₂O lower than the set PEEP/CPAP).

Inspect mask fit and position

Inspect the mask position regularly and adjust as necessary. React promptly and appropriately to any alarms.

The ventilator's V_{Leak} parameter provides one indicator of mask fit.

To verify that the mask fits properly, ensure that the leakage value shown in the **Monitoring** window (V_{Leak} , MV_{Leak}) is acceptable.

To monitor leakage during ventilation, set the low limit of the **Pressure** alarm to a value near the set pressure for ventilation ($PEEP/CPAP + \Delta P_{Insp}/\Delta P_{Support}$). When excessive leaks are present, the ventilator may not be able to reach the set pressure, and generates an alarm.

7.9 Working with ASV

ASV is indicated for passive and spontaneously breathing adult and pediatric patients.

7.9.1 Contraindications

ASV and ASV 1.1 are contraindicated with the following:

- Infants and neonates
- If there is a high leakage (NIV or broncho-pleural fistula)
- Irregular respiratory drive (Cheyne-Stokes respiration)

7.9.2 Setting up ASV on the ventilator

To set up the ventilator using ASV

1. Touch **Modes**.
2. Touch **ASV**, then touch **Confirm**.
3. Set the controls as appropriate:
 - %MinVol: Set a value that results in the same minute volume as a previous mode, if applicable.
 - PEEP, Oxygen, Trigger, ETS, P-ramp: Set according to clinical requirements and the patient condition.

4. Review and adjust alarm limits.

Set the high Pressure alarm limit to an appropriate value.

The maximum peak pressure delivered in ASV (Plimit) is 10 cmH₂O below the high Pressure alarm limit or equal to the Plimit setting.

The maximum peak pressure for ASV can be also set using the Plimit control in the Controls window.

Changing the Plimit value also changes the high Pressure limit. For details, see Section 5.5.2.

5. Connect the patient to the ventilator and start ventilation.

The ventilator initiates several test breaths.

The device automatically selects the values for respiratory rate (f_{Total}), inspiratory time (TI), and inspiratory pressure (ΔP_{Insp}) based on the calculated IBW and as specified in Table 7-4.

7.9.3 Clinical workflow with ASV

Figure 7-16 provides an overview of the ASV clinical workflow.

For technical specifications, see Section 16.9.

Figure 7-16. Clinical use of ASV

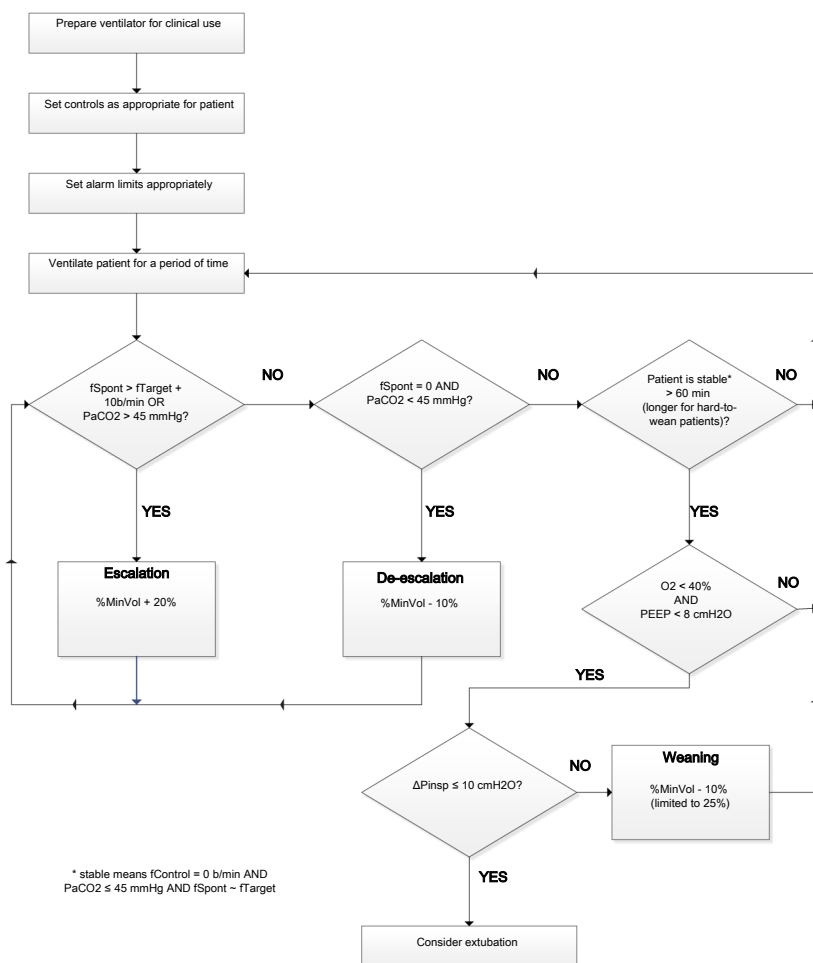

7.9.4 Maintaining adequate ventilation

WARNING

To change the minute volume setting, always use the %MinVol control. Do *not* manipulate the patient height setting to achieve the desired IBW to control minute volume.

Once ASV is started, the ventilator calculates an optimal breath pattern and associated target values for tidal volume and rate according to the rules in ASV and the set %MinVol to achieve the targets. Depending on whether the patient is passive or actively breathing, the ventilator delivers pressure-controlled or pressure-supported breaths in compliance with a lung-protective strategy. For details, see Section 7.9.8.4.

Once the calculated targets are reached, the result of the ventilation needs to be assessed. All monitored parameters can be used for this purpose.

However, to assess respiratory acid-base status, it is recommended that arterial blood gases be measured and minute ventilation be adjusted accordingly.

Table 7-8 provides examples of how to adjust the %MinVol setting.

Table 7-8. Blood gas and patient conditions and possible adjustments for ASV

Condition	%MinVol change
Normal arterial blood gases	None
High PetCO ₂ or PaCO ₂	Increase %MinVol Pay attention to inspiratory pressures
Low PaCO ₂	Decrease %MinVol Pay attention to mean pressures and oxygenation status
High respiratory drive	Consider increase in %MinVol Consider sedation, analgesia, or other treatments
Low O ₂ saturation	None Consider increase in PEEP/CPAP and/or Oxygen

7.9.5 Reviewing alarm settings

It is *not* possible to select a %MinVol that is incompatible with the lung-protective rules that govern ASV (for a detailed description, see Section 7.9.8.4). As a consequence, ASV tries to achieve the maximum possible ventilation and activates the ASV: Cannot meet target alarm.

Figure 7-17. Example of high %MinVol setting incompatible with the lung-protective rules strategy

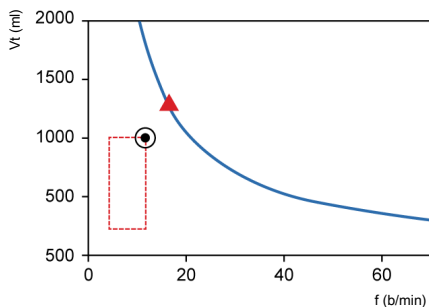

7.9.6 Monitoring ASV

ASV interacts with the patient continuously. Whenever the patient's respiratory mechanics change, ASV adjusts to this change. Whenever the patient's breathing activity changes, ASV adjusts the settings.

The ASV graph, shown in Figure 7-18, provides a real-time graphical view of the patient status relative to the set target. For details about the graph, see Section 8.4.3.

For details on displaying the ASV graph and ASV monitoring values, see Section 8.4.

To monitor progress over time, it is recommended that you plot trends for ΔP_{insp} , f_{Total} , and f_{Spont} . Review these trends, together with the %MinVol setting to gain insight into the patient's ventilatory status. Table 7-9 provides interpretations of typical ventilatory patterns.

Figure 7-18. ASV Graph panel

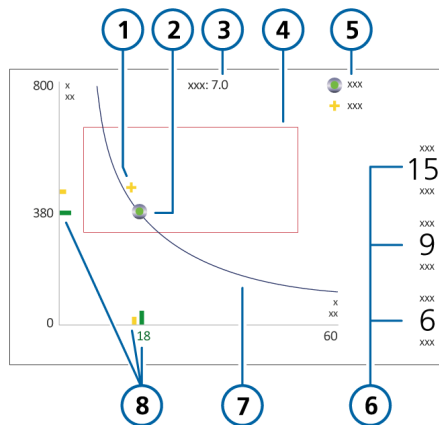

- | | |
|--|---|
| 1 Patient symbol:
intersection of
current measured
tidal volume and
rate | 5 Legend |
| 2 Target point:
Intersection of
target tidal
volume and
target rate | 6 ΔP_{insp} : Inspira-
tory pressure set
by ventilator

$f_{Control}$: Machine
rate

f_{Spont} : Sponta-
neous breath rate |
| 3 Target minute
volume | 7 Minute volume
curve |
| 4 Safety frame | 8 Current measured
point (in yellow)
and target value
(in green) |

7.9.7 Weaning

Weaning patients from the ventilator is a clinical task that requires experience and involves more than just ventilation issues. This section does not intend to provide clinical information other than that needed to operate the ventilator using ASV mode.

ASV always allows patients to take spontaneous breaths. Episodes of spontaneous breathing can occur and are supported by ASV even within a period of fully controlled ventilation. In other words, weaning can start with ASV so early that it may go unrecognized clinically. It is therefore important to monitor the spontaneous efforts of the patient over time.

The weaning progress can be monitored in the trends display when inspiratory pressure (ΔP_{insp}), total rate (f_{Total}), and spontaneous rate (f_{Spont}) are plotted.

It may be necessary to reduce the %MinVol setting to 70% or even lower to “motivate” the patient to resume spontaneous breathing. If a patient can sustain minutes or even hours with a low %MinVol setting, it does not mean that weaning is complete. In fact, the %MinVol setting must always be interpreted in conjunction with the level of ΔP_{insp} needed to achieve the set minute ventilation. Only if ΔP_{insp} and $f_{Control}$ are at their minimum values can weaning be assumed to be complete.

Table 7-9. Interpretation of breathing pattern at lower than 100 %MinVol setting

ΔP_{insp}	$f_{Control}$	f_{Spont}	Interpretation
> 10	> 10	0	<i>Danger of hypoventilation.</i> Check arterial blood gases and consider increasing %MinVol.
> 10	0	Acceptable	<i>Enforced weaning pattern.</i> Check arterial blood gases and patient respiratory effort. Consider decreasing or increasing %MinVol accordingly.
< 8	0	Acceptable	<i>Unsupported breathing.</i> Consider extubation.
> 10	0	High	<i>Dyspnea.</i> Consider increasing %MinVol and other clinical treatments. Check for autotriggering.

7.9.8 Functional overview

7.9.8.1 Normal minute ventilation

ASV defines **normal** minute ventilation according to the graph in Figure 7-19.

Figure 7-19. Normal minute ventilation as a function of ideal body weight (IBW)

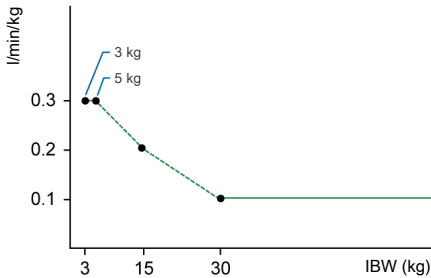

For patients with an IBW of 30 kg or more, minute ventilation is calculated as $0.1 \text{ l/kg} * \text{IBW}$ (solid line).

For patients with an IBW below 30 kg, the value is indicated by the dotted line in the previous figure.

Minute ventilation for a 15 kg patient is calculated as

$$0.2 \text{ l/kg} * 15 \text{ kg} = 3 \text{ l/min}$$

For example, for an IBW of 70 kg, **normal** minute ventilation corresponds to 7 l/min.

7.9.8.2 Compensation for changes in apparatus dead space

Dead space is calculated as 2.2 ml per kg. This dead space is a nominal value that is valid, on average, for intubated patients whose endotracheal tube is connected to the Y-piece of the ventilator by a standard catheter mount.

Changes in alveolar dead space due to ventilation/perfusion mismatch must be compensated using the %MinVol control.

If this dead space is altered by an artificial airway configuration, such as the use of a heat and moisture exchanging filter (HMEF) or nonstandard tubing, modify the %MinVol setting to take into account the added or removed dead space.

7.9.8.3 Targeted minute ventilation

When you choose ASV, you must select an appropriate minute ventilation for the patient. Minute ventilation is set with the %MinVol control, which, together with the patient height, determines the total minute ventilation in liters per minute (l/min).

A %MinVol setting of 100% corresponds to **normal** minute ventilation (Section 7.9.8.1). A setting below or above 100% corresponds to minute ventilation lower or higher than normal.

From the %MinVol, the target minute ventilation (in l/min) is calculated as:

$$\text{Ideal body weight (in kg)} \times \text{NormMinVent (in l/kg/min)} \times (\% \text{MinVol}/100)$$

where **NormMinVent** is the **normal** minute ventilation. See Figure 7-19.

For example, with a %MinVol = 100 and an IBW = 70 kg, a target MinVol of 7 l/min is calculated. This target can be achieved with a number of combinations of tidal volume (Vt) and respiratory rate (f). This is shown in Figure 7-20, where all possible combinations of Vt and f lie on the bold line, the target minute volume curve.

Figure 7-20. MinVol = 7 l/min

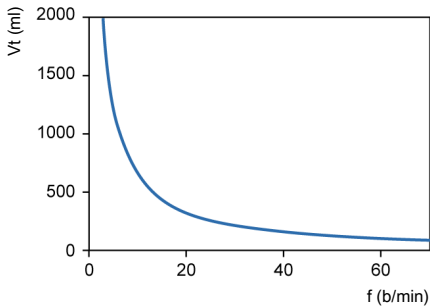

7.9.8.4 Lung-protective strategy

Not all combinations of Vt and f shown in Figure 7-20 are safe for the patient. The high tidal volumes will overdistend the lungs, and the small tidal volumes cannot produce alveolar ventilation at all.

Another risk lies in inadequate respiratory rates. High rates can lead to dynamic hyperinflation or breath stacking, and thus inadvertent PEEP. Low rates can lead to hypoventilation and apnea. Therefore, it is necessary to limit the number of possible combinations of Vt and f.

When limits are imposed on the possible combinations of Vt and f, ASV uses a double strategy:

- The operator input for ASV determines the absolute boundaries.

- Internal calculations based on patient measurements further narrow the limits to counteract possible operator errors and to follow changes of respiratory system mechanics.

The effect of the strategy is shown in Figure 7-21 and explained in the subsequent sections.

Figure 7-21. Lung-protective rules strategy

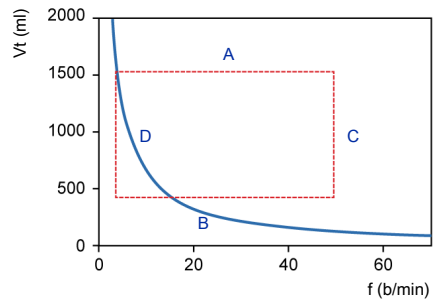

A: High tidal volume limit

The tidal volume applied by ASV is limited (see A in Figure 7-21) by three operator settings: high Pressure alarm limit, high Vt alarm limit, and patient height.

Note the following:

- You must set the high Pressure limit before connecting a patient to the ventilator. The maximum pressure applied in the ASV mode is 10 cmH2O below the high Pressure alarm limit.
- Additionally, the target volume is limited to 150% of the high Vt alarm limit, and pressure support is limited such that the inspired volume does not exceed the high Vt alarm limit in mechanical breaths for more than a few breaths.

- If you set the Pressure alarm limit to a very high pressure, say 60 cmH₂O, the target volume is limited by the second criterion: 15 ml/kg.
- Check the Vt high setting to make sure the target minute ventilation can be reached in passive patients.

B: Low tidal volume limit

You must use caution with low tidal volumes to avoid insufficient alveolar ventilation.

The determining parameter for alveolar ventilation is dead space (VDaw). Tidal volume value must always be greater than the VDaw value. It is widely accepted that a first approximation of dead space can be obtained by the following simple equation (Radford 1954):

$$VDaw = 2.2 * IBW$$

ASV calculates the lower limit for tidal volume based on the following equation: IBW * 4.4 ml/kg. The multiplying factor is calculated to be at least twice the dead space.

C: High rate limit

You derive the maximum rate (C in Figure 7-21) from the operator-set %MinVol and the calculated IBW, which is calculated from the operator-set patient height (Pat. height). The equation used to calculate the maximum rate is:

$$fmax = \text{target MinVol} / \text{minimum Vt}$$

However, if you choose an excessively high %MinVol of 350%, the maximum rate becomes 77 b/min. To protect the patient against such high rates, ASV employs a further safety mechanism, which takes into account the patient's ability to exhale.

A measure of the ability to exhale is the expiratory time constant (RCexp). To achieve a nearly complete exhalation to the equilibrium point of the respiratory system (90% of the maximum potential volume change), an expiratory time of at least 2 * RCexp is theoretically required.

For this reason, ASV calculates the maximum rate based on the principle of giving a minimum inspiratory time equal to 1 * RCexp and a minimum expiratory time equal to 2 * RCexp, which results in these equations:

$$fmax = 60 / (3 * RCexp) = 20 / RCexp$$

$$fmax \leq 60 \text{ b/min}$$

This limit applies to the respiratory rate of the ventilator only, *not* to the respiratory rate of the patient.

D: Low rate limit

The lowest target rate (see D in Figure 7-21) is predefined according to the IBW. See Table 7-4.

7.9.8.5 Optimal breath pattern

Although the lung-protective rules strategy limits possible combinations of Vt and f, ASV prescribes an explicit target combination. Using the example in Figure 7-21, this shows considerable room for selection within the dotted rectangle. The selection process is an exclusive feature of ASV.

The device works on the assumption that the optimal breath pattern is identical to the one a totally unsupported patient will choose naturally (assuming the patient is capable of maintaining the pattern).

It is common knowledge that the choice of breathing pattern is governed by either work of breathing or the force needed to maintain a pattern. ASV calculates the optimal rate based on the operator-set %MinVol and the calculated IBW, as well as on the measurement of RCexp (Section 7.5.1).

Once the optimal rate is determined, the target Vt is calculated as follows:

$$V_t = \text{target MinVol} / \text{optimal rate}$$

Figure 7-22 shows the position of the target breathing pattern as well as the safety limits imposed by the lung-protective rules strategy. The rectangle shows the safety limits; the circle shows the target breath pattern.

Figure 7-22. Anatomy of the ASV target graphics window

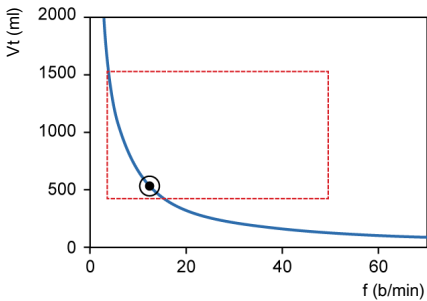

7.9.8.6 Initial breaths: How ASV starts

How do you achieve the target values for a given patient if you do not know whether or not the patient can breathe spontaneously? For this purpose, ASV uses a predefined rate according to the calculated IBW. For more information see Table 7-4.

Patient-triggered breaths are pressure supported and flow cycled, or, the transition to exhalation is made based on IntelliSync +, if selected.

If the patient does not trigger the breath, the delivery of the breath is time cycled, with a preset pressure.

The following controls are operator-set (manual):

- PEEP/CPAP
- Oxygen
- P-ramp
- ETS
- Trigger type and sensitivity

This list of controls is adjusted automatically by ASV, and cannot be adjusted by the operator:

- *Mandatory breath rate*: to change total respiratory rate
- *Inspiratory pressure level*: to change inspiratory volume
- *Inspiratory time*: to allow gas flow into the lungs
- Startup breath pattern

To safely start ASV, you set the patient height (Pat. height) and sex, which are then used to calculate the IBW.

Upon starting ventilation, after some initial test breaths are delivered, the resulting rate and tidal volume are measured and compared with the target values. ASV then responds to the differences between the current and target tidal volumes, as well as the current and target rates.

7.9.8.7 Approaching the target

Figure 7-23 shows a possible scenario after the initial test breaths. The current breath pattern, which is plotted as the patient symbol, shows clear deviation from the target. ASV's task is to move the patient symbol as close to the circle as possible.

Figure 7-23. Example after three initial breaths

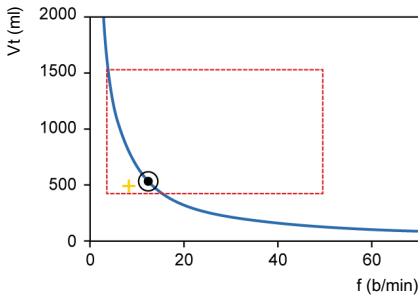

The patient symbol marks the actual measured value for V_t and Rate.

To achieve the target, ASV uses the following strategy:

- If actual $V_t <$ target V_t , the inspiratory pressure is increased.
- If actual $V_t >$ target V_t , the inspiratory pressure is decreased.
- If actual $V_t =$ target V_t , the inspiratory pressure is left unchanged.
- If actual rate $<$ target rate, the $f_{Control}$ rate is increased.
- If actual rate $>$ target rate, the $f_{Control}$ rate is decreased.
- If actual rate $=$ target rate, the $f_{Control}$ rate is left unchanged.

As a result, the patient symbol in Figure 7-23 moves toward the circle. The current V_t is calculated as the average of inspiratory and expiratory volumes. This defini-

tion compensates in parts for leaks in the breathing circuit, including the endotracheal tube.

7.9.8.8 Dynamic adjustment of lung protection

The operator preset values are not changed by ASV, and the corresponding safety limits remain as defined in the previous sections. However, if the respiratory system mechanics change, the safety limits change accordingly, as defined in Section 7.9.8.4. The safety limits are updated on a breath-by-breath basis.

For example, if the lungs stiffen, the high V_t limit is lowered proportionally, and the high rate limit is increased.

This dynamic adjustment ensures that ASV applies a safe breathing pattern at all times. In graphical terms, the dotted rectangle changes as shown in Figure 7-24.

Figure 7-24. Lung-protective limits

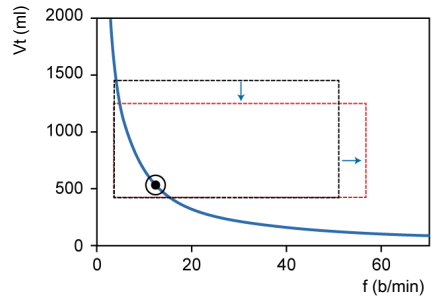

Lung-protective limits are changed dynamically and according to the respiratory system mechanics.

However, the limits set by the operator are never violated.

7.9.8.9 Dynamic adjustment of optimal breath pattern

After it is calculated, the optimal breath pattern is revised with each breath according to the RC_{exp} measurements. A new target breathing pattern is calculated using ASV algorithms. The targets do not change under steady-state conditions. However, if the patient's respiratory system mechanics change, the target values also change.

8

Monitoring ventilation

8.1	Overview.....	168
8.2	Viewing numeric patient data	168
8.3	Viewing graphical patient data	171
8.4	Working with Intelligent panels	178
8.5	Monitoring transpulmonary/esophageal pressure	183
8.6	About the monitored parameters	184
8.7	Viewing patient ventilation time	193
8.8	Viewing device-specific information	194

8.1 Overview

You can configure how to view patient data during ventilation, including viewing data numerically and graphically in a combination of waveforms, loops, trends, and Intelligent Panel graphics to suit your institution's needs (Figure 8-1).

Data is also available in the **Monitoring** window, which you can access at any time without affecting breath delivery.

For the list of monitored parameters, see Section 8.6.

Figure 8-1. Main display

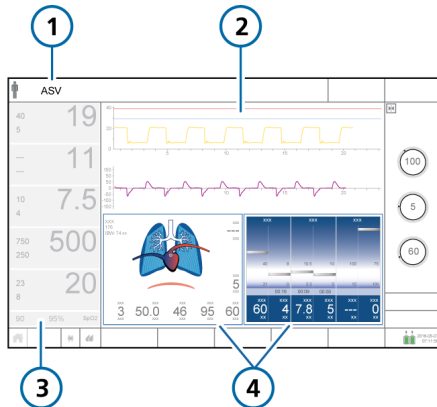

- | | |
|----------------|--|
| 1 Current mode | 3 Main monitoring parameters (MMP) (Section 8.2.1) |
| 2 Waveforms | 4 Graphic display, configurable (Section 8.3) |

8.2 Viewing numeric patient data

Numeric patient data is readily available as follows:

- The main display prominently shows the configured main monitoring parameters (MMPs). See Section 8.2.1.
- The **Monitoring** panel, when shown, displays secondary monitoring parameters (SMPs). See Section 8.2.2.
- The **Monitoring** window provides access to all of the parameter data. See Section 8.2.3.

8.2.1 About the main monitoring parameters (MMP)

The MMPs are the numerical monitoring parameters shown on the left side of the display. Every displayed parameter shows the following elements: the current value, name, and unit of the monitoring parameter, and the set alarm limits, when applicable.

The MMPs that are displayed, as well as their sequence on the display, can be changed in **Configuration** (Chapter 14). Any of the monitored parameters can be displayed as an MMP. As a result, MMPs may differ between individual ventilators. Note that **Ppeak** is always displayed.

If **Oxygen** is selected as an MMP, the alarm limits are shown as follows:

- If the oxygen limits are automatically set, they are set to 5% (absolute) above and below the **Oxygen** control setting.
- If the **Set Oxygen** alarm limits manually checkbox is selected in **Configuration**, the limits are set manually in the **Alarms** window, and these values are shown next to the MMP.

An MMP is normally displayed in white. When directly related to an active alarm, the MMP is shown in yellow or red, corresponding to the alarm priority. In addition, a colored bar appears to the right of the affected MMP (Figure 8-2). After the alarm resets, the MMP returns to white and the bar is removed.

Tip. Touch any MMP to display the Alarms window to adjust the limits.

Figure 8-2. MMP components

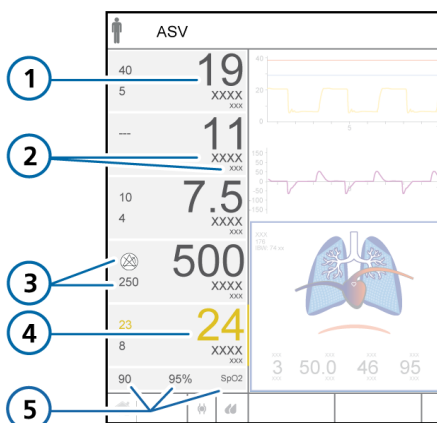

- | | | | |
|---|--------------------------|---|--|
| 1 | MMP value | 4 | Parameter associated with active alarm |
| 2 | Parameter name/units | 5 | SpO2 lower alarm limit, SpO2 value* |
| 3 | Upper/lower alarm limits | | |

* If SpO2 sensor is enabled and connected

8.2.2 About the secondary monitoring parameters (SMPs)

Additional parameter data, referred to as secondary monitoring parameters (SMPs), is available in the Monitoring panel.

Figure 8-3. Monitoring panel for SMPs (1)

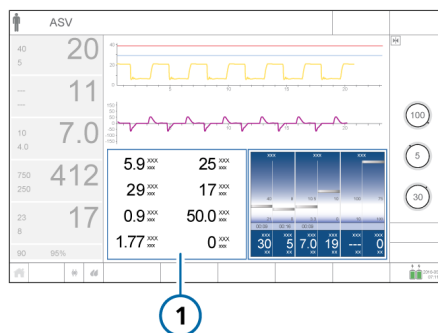

The parameters shown in this panel are configurable; see Section 14.5.

The following parameters are shown as SMPs by default: Vt/IBW (Adult/Ped) or Vt/Weight (Neonatal), Pplateau, RCexp, TI, Driving pressure (ΔP), Pmean, Cstat, and fSpont.

The Monitoring panel showing SMPs can be displayed with graphic layouts 2 and 3 (Table 8-2).

To display the Monitoring panel

1. Touch the area of the display where you wish to show the SMPs (Section 8.3.1).
2. In the graphics selection window, touch the **Graphics** tab.
3. Touch the **Monitoring** button (Figure 8-4).

The **Monitoring** panel showing SMPs is displayed (Figure 8-3).

Figure 8-4. Graphics selection > Graphics window

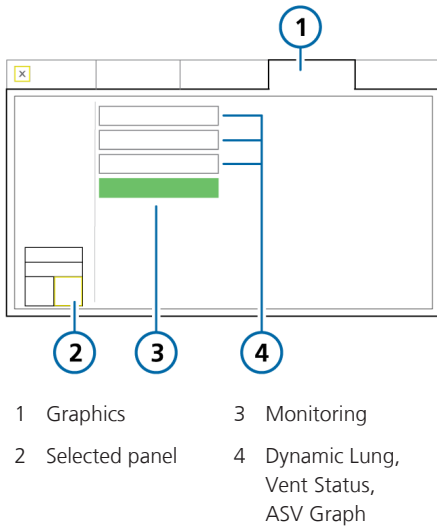

8.2.3 Viewing patient data in the Monitoring window

The **Monitoring** window provides access to monitored parameter data as follows:

- The **General** tab (Figure 8-5) provides access to ventilation parameter values.
- The **CO2** and **SpO2** tabs, when available, provide access to CO2- and SpO2-related parameter values, respectively.
- When used, the **Pes** tab provides access to esophageal and transpulmonary pressure parameters.

Figure 8-5. Monitoring > General window

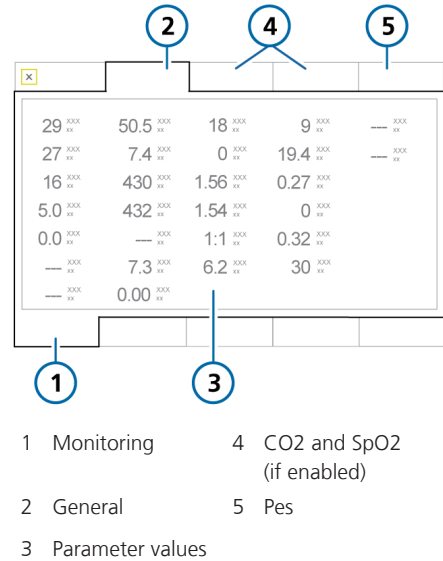

To display the Monitoring > General window

- ▶ Touch **Monitoring**.
 The **Monitoring > General** window is displayed.

8.3 Viewing graphical patient data

In addition to numerical data, the ventilator shows user-selectable graphical views of real-time patient data (Table 8-1).

The ventilator offers multiple views of this data, and, within preconfigured layouts, allows you to select what to display and where. You choose a layout to show your desired combination of full- and half-screen waveforms, graphics, and informational panels.

You can change individual elements, as well as the display layout, at any time.

Table 8-1. Graphical view options

Graphic type	Options
Waveforms (Data values plotted against time)	<ul style="list-style-type: none"> • Pressure • Flow • Volume • Off • PCO₂⁵² • FCO₂⁵² • Plethysmogram⁵³ • Pes⁵⁴ • Ptranspulm⁵⁴
Graphics (Intelligent panels)	<ul style="list-style-type: none"> • Dynamic Lung⁵⁵ • Vent Status • ASV Graph⁵⁶ • Monitoring (SMPs)
Trends	1-, 6-, 12-, 24-, or 72-h trend data for a selected parameter or combination of parameters

⁵² CO₂ option required.

⁵³ SpO₂ option required.

⁵⁴ Data is available only when an esophageal catheter is connected to the Pes port on the ventilator.

⁵⁵ Only for adult/pediatric patients.

⁵⁶ Only in ASV mode.





Graphic type	Options
Loops	<ul style="list-style-type: none"> • Pressure/Volume • Pressure/Flow • Volume/Flow • Volume/PCO₂⁵² • Volume/FCO₂⁵² • Pes/Volume⁵⁴ • Ptranspulm/Volume⁵⁴

8.3.1 Selecting a display layout

While you can select a layout and the graphics to display, you can also revert back to the default layout at any time.

Table 8-2 describes the layout options.

Table 8-2. Graphic layout options

	<i>Layout 1.</i> Four full-screen waveforms
	<i>Layout 2.</i> Two full-screen waveforms and any combination of graphic panels and half-screen waveforms
	<i>Layout 3.</i> Any combination of half-screen waveforms and graphic panels
	<i>Layout 4.</i> Full-display dynamic lung

The graphic choices you make for a selected layout are saved for the current patient until you manually change them.

When setting up a new patient, each layout reverts to the default graphics specified in the selected **Quick Setup**.

Tip. When setting up a new patient, you can individually set up Layouts 1, 2, and 3 with your preferred graphics, and then later quickly switch between these views at any time by selecting the desired layout in the **Graphics** window.

To change the layout of the display graphics

1. Touch **Graphics** (Figure 8-6).
2. Touch the desired layout option.
To revert to the default layout configuration, touch **Defaults**.

The window closes automatically, and the display adjusts to the new selection.

Figure 8-6. Graphics window, layout options

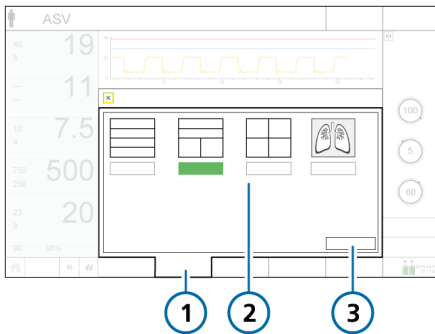

- 1 Graphics
- 2 Layouts 1, 2, 3, 4
- 3 Defaults

8.3.2 Selecting display options

You can change the graphics at any time.

To change the contents of a graphic panel or waveform

1. Touch the area of the display to change.
The selected panel is highlighted in yellow (Figure 8-7).
The graphics selection window appears, displaying the current selection (Figure 8-8).
2. Touch the desired option to select it, or touch a tab (**Trends, Loops, Graphics, Waveforms**) to access additional options.

After making a selection, the window closes automatically, and the display adjusts to the new selection.

Figure 8-7. Selected panel outlined in yellow

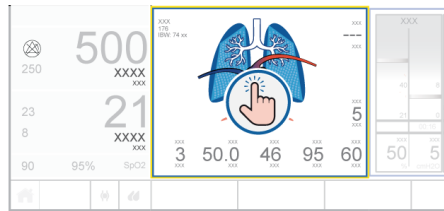
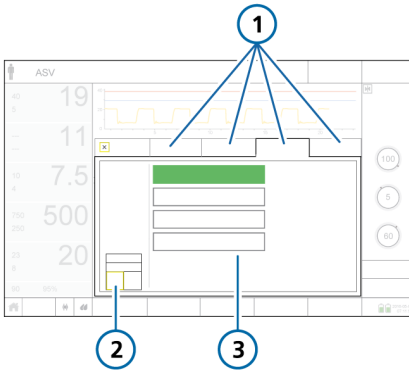

Figure 8-8. Graphics selection window



- 1 Trends, Loops, Graphics (shown), Waveforms
- 2 Selected panel
- 3 Available options

8.3.3 Working with waveforms

The ventilator can plot pressure, volume, and flow against time, in addition to other data as listed in Table 8-1.

The waveforms provide an ongoing real-time graphical view of the selected parameters over multiple breaths. As a result, they also provide a way to assess the numerical monitored parameter values.

8.3.3.1 Waveform views

You can show one or more waveforms on the display, depending on which layout option you select.

Figure 8-9. Waveform layout options

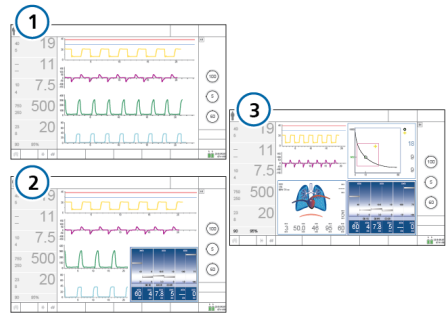

- 1 *Layout 1.* Up to four full-screen waveforms
- 2 *Layout 2.* Up to two full-screen waveforms and two or more half-screen waveforms
- 3 *Layout 3.* A combination of two or more half-screen waveforms and graphic panels

8.3.3.2 Displaying waveforms

You select waveform options in the **Waveforms** window.

Figure 8-10. Graphics selection > Waveforms window

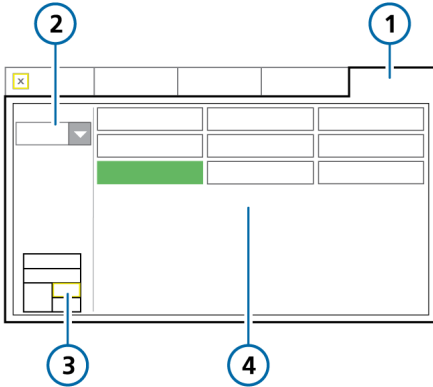

- | | |
|--------------|---------------------|
| 1 Waveforms | 3 Selected panel |
| 2 Time scale | 4 Available options |

To add or change a full-screen waveform

1. Touch the waveform to change (Section 8.3.2).
The graphics selection window appears, with the **Waveforms** tab selected (Figure 8-10).
2. If needed, change the time scale to apply to all waveforms.
3. Touch the waveform type to display.
To leave the area blank, touch **Off**.⁵⁷
Once selected, the window closes and the selected waveform is displayed.

To add or change a half-screen waveform

1. Touch the graphic panel or waveform to change.
The graphics selection window opens (Figure 8-10).
2. If not already displayed, touch the **Waveforms** tab (Figure 8-10).
The layout on the left indicates which waveform you are configuring (top or bottom).
3. If needed, change the time scale to apply to all waveforms.
4. Touch the waveform type to display.
To leave the area blank, select **Off**.⁵⁷
After making your selection, one of the following occurs:
 - If you are adding or changing a single waveform, the window closes and the selected waveform is displayed.
 - If you are replacing a graphic panel with waveforms, the window shows the options for the second waveform.
5. For a second waveform, select the waveform type to display.

Once the selection is made, the window closes and the selected waveform is displayed.

Figure 8-11. Two half-screen waveforms

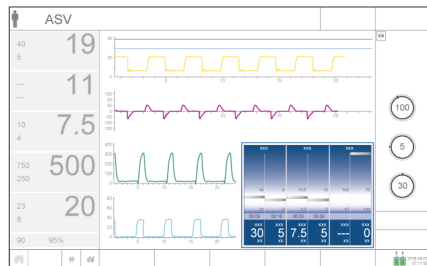

⁵⁷ The OFF option is disabled for the topmost full-screen waveform in Layouts 1 and 2, and for the left topmost waveform in Layout 3.

8.3.3.3 About the Pressure/time (Paw) graph

The blue pressure limit line shows the maximum pressure that the ventilator will apply, which you can set using the **Plimit** control. The high Pressure alarm limit is shown as a red line. The high Pressure alarm limit is always 10 cmH₂O greater than **Plimit**.

Figure 8-12. Pressure/time graph

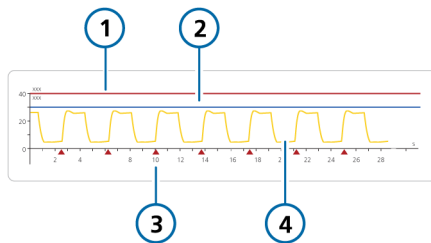

- | | |
|-----------------------------|----------------------------------|
| 1 High Pressure alarm limit | 3 Patient trigger indicator |
| 2 Plimit | 4 Airway pressure (Paw) waveform |

When TRC is enabled, the tracheal pressure (**P_{trach}**) waveform (orange) is shown together with the **Paw** waveform (yellow). See Section 5.5.5.

8.3.3.4 Changing the waveform time scale

Scaling refers to the values of the x- and y-axis of a waveform or a loop. In the waveforms displayed on the ventilator, the x-axis represents time, while the y-axis can represent a variety of parameters, including pressure, flow, or volume.

You can set the time scale (x-axis values) of the waveforms; your selection applies to all displayed waveforms.

A scale value refers to the length of the x-axis. For example, a scale value of 22 means that the x-axis displays the waveform from 0 to 22 seconds.

When you switch from layouts 1 or 2 to layout 3, the waveform time scale increases. When switching from layout 3 to either layout 1 or 2, the waveform time scale decreases.

The HAMILTON-C6 offers the following time scale options, in seconds:

- *Full-screen waveforms (Layouts 1 and 2):* 11, 22, 33, 66
The default for the **Adult/Ped** patient group is 22; for **Neonatal**, 11.
- *Half-screen waveforms (Layout 3):* 5.5, 11, 22, 33

To change the time scale

- ▶ In the **Waveforms** window, touch the **Time scale** arrow (Figure 8-10) and select the time scale to use.

Your selection applies to all displayed waveforms.

8.3.3.5 Freezing and reviewing waveforms and trends

You can temporarily freeze the display of waveforms and trends. After 30 seconds of inactivity, they are automatically unfrozen.

When Freeze is enabled, any displayed waveforms and trend graphs are frozen, allowing you to scroll through them for a detailed review. The Freeze function is time-synced across the displayed waveforms.

The Freeze function is particularly useful when you perform a breath hold maneuver. The display automatically freezes following a successful inspiratory or expiratory hold maneuver.

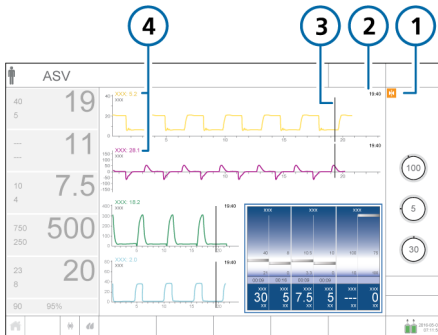

Note that when Freeze is enabled, all of the elements on the display are unavailable.

Figure 8-13. Freezing waveforms



- | | |
|------------------|--|
| 1 Freeze button | 3 Cursor |
| 2 Time at cursor | 4 Value at cursor (same color as the waveform) |

To freeze waveforms

1. Touch  (Freeze).
Any displayed waveforms and Trend graphs are frozen, and cursor bars are displayed.
2. To scroll through the graphics for analysis, do either of the following:
 - Slide your finger along a waveform or trend. The cursor moves to where your finger is.
 - Turn the P&T knob clockwise or counter-clockwise.
 The cursor bars move to the right and to the left.
3. To unfreeze the display, touch  again or press the P&T knob.

The display returns to displaying real-time data and all of the elements on the display are available.

8.3.4 Working with Trend graphs

Trend data includes all data since the ventilator was turned on for a selected parameter for the past 1, 6, 12, 24, or 72 hours.

Figure 8-14. Trend panel

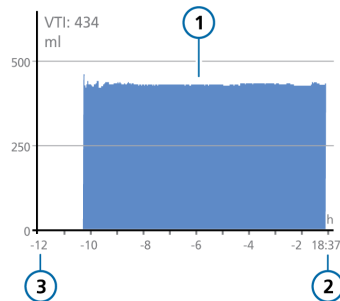

- | | |
|----------------|------------------------------------|
| 1 Trend graph | 3 Elapsed time relative to present |
| 2 Current time | |

From the time the ventilator is turned on, it continuously stores up to 72 hours of monitored parameter data in its memory, including when in **Standby**. This data is deleted upon setting up a new patient.

You can also freeze trend graphs and examine them more closely. When trends are frozen, the panel shows the time and the corresponding value of the monitored parameter.

Most monitoring parameters can be trended. The following parameters are trended in combination: Ppeak/PEEP, ExpMinVol/MVSpont, fTotal/fControl, VDaw/VTE, VTE/Vtalv, and SpO2/Oxygen and SpO2/FiO2 (if supported on your device).

8.3.4.1 Displaying trends

Trend graphs can be displayed using graphic layouts 2 and 3 (Table 8-2).

Figure 8-15. Graphics selection > Trends window

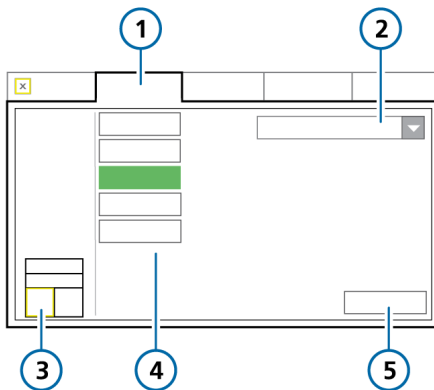

- | | |
|------------------|------------------------|
| 1 Trends | 4 Trend time, in hours |
| 2 Parameter list | 5 Confirm |
| 3 Selected panel | |

To display trends

1. Touch the area of the display where you wish to show a trend graph (Section 8.3.2).
2. In the graphics selection window, touch the **Trends** tab (Figure 8-15).
3. Select the parameter(s) to trend.
4. Touch the desired trend time.
The selected time applies to all displayed trends.
5. Touch **Confirm**.

The selected trend information is displayed (Figure 8-14).

8.3.5 Working with loops

The HAMILTON-C6 can display a dynamic loop based on the parameter combinations listed in Table 8-1.

Figure 8-16. Loops panel, Pressure/Volume loop displayed

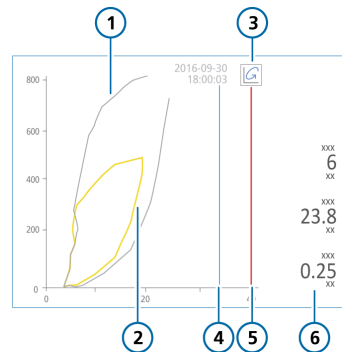

- | | |
|-------------------------|--|
| 1 Stored reference loop | 4 Plimit (high Pressure alarm limit – 10 cmH2O)* |
| 2 Current loop | 5 High Pressure alarm limit* |
| 3 Loop reference button | 6 Key parameters |

* Displayed if applicable

8.3.5.1 Displaying loops

Loops can be displayed in layouts 2 and 3 (Table 8-2).

Figure 8-17. Graphic selection > Loops window

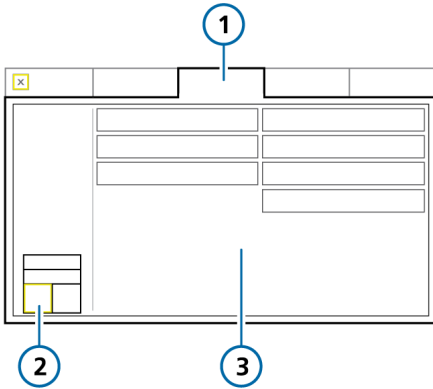

- 1 Loops
- 2 Selected panel
- 3 Parameter options

To display loops

1. Touch the area of the display where you wish to show a loop (Section 8.3.2).
2. In the graphics selection window, touch the **Loops** tab.
3. Touch the parameter combination to display.

The selected combination is displayed (Figure 8-16).

8.3.5.2 Storing loops

You can store a loop to use as a reference, for comparison purposes.

To store a new loop

- ▶ In the **Loop** display (Figure 8-16), touch  (Loop reference) to store the loop curve with the current date and time.

The previous and current characteristics are shown. Any previously stored loop is discarded.

8.4 Working with Intelligent panels

You can show any of the following Intelligent panels on the ventilator display:

- Vent Status
- Dynamic Lung
- ASV Graph
- Monitoring (SMPs) (Section 8.2.2)

The Intelligent panels are all displayed using the graphics selection window **Graphics** tab.

8.4.1 Dynamic Lung panel: real-time ventilation status

The **Dynamic Lung**⁵⁸ shows an up-to-date visual representation of key ventilation data (Figure 8-18). It visualizes tidal volume, lung compliance, patient triggering, resistance, and cuff pressure in real-time.

In addition to the graphic representation, the panel shows numeric data for key parameters. If all values are in a normal range, the panel is framed in green.

⁵⁸ Only for adult/pediatric patients.

The Dynamic Lung comprises the following components:

- Mechanical breath
- Respiratory compliance
- Airway resistance
- Patient triggering
- SpO2 data (if installed and enabled)
- IntelliCuff data (if connected and active)

Figure 8-18. Dynamic Lung panel

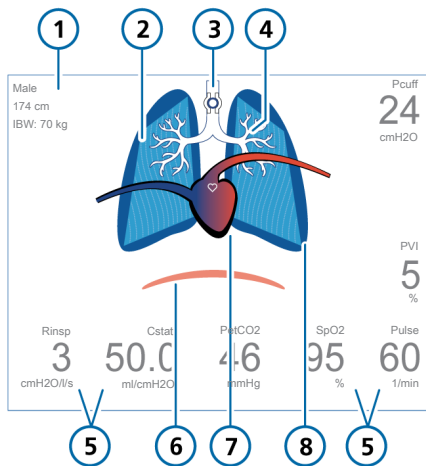

- | | |
|---------------------------------------|--|
| 1 Sex, height, IBW | 5 Monitored parameter values |
| 2 Representation of lung compliance | 6 Patient trigger (diaphragm) |
| 3 Cuff indicator* | 7 Heart and pulse display** |
| 4 Representation of airway resistance | 8 Representation of breaths and tidal volume |

* If IntelliCuff is connected and active.
 ** If SpO2 sensor enabled and connected.

Mechanical breaths, with tidal volume

The mechanical breath is shown as a set of lungs that expand and contract in synchrony with ventilator breath delivery, showing the delivered tidal volume (Vt) in real-time. The lung size displayed is relative to the “normal” size for the patient’s height.

A Disconnection alarm is indicated by a deflated lung. An Exhalation obstructed alarm is indicated by an over-inflated lung.

The movement and shape of the lungs allows you to quickly verify that the ventilator is ventilating the patient.

Respiratory compliance

Respiratory compliance is a measure of the lung’s ability to stretch and expand. Compliance is illustrated by the contour lines of the lung, as shown in Figure 8-19. The static measurement is provided with the Cstat parameter.

Figure 8-19. Examples of lung compliance (Cstat) illustrated in Dynamic Lung

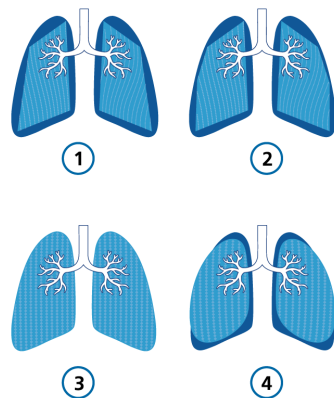

- | | |
|-----------------------|---------------------|
| 1 Very low compliance | 3 Normal compliance |
| 2 Low compliance | 4 High compliance |

Airway resistance

Airway resistance refers to the total resistance imposed by the patient’s airway as well as the artificial airway, such as an endotracheal tube or tracheostomy tube. Airway resistance is illustrated by the size and color of the tracheobronchial tree, as shown in Figure 8-20. The resistance measurement is provided with the **Rinsp** parameter.

Figure 8-20. Examples of resistance shown by the bronchial tree of the Dynamic Lung

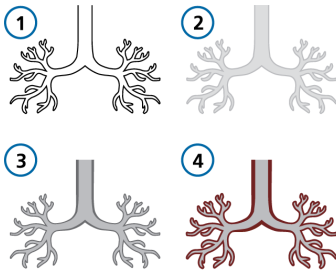

- 1 Resistance information is unavailable
- 2 Normal resistance
- 3 Moderate resistance
- 4 High resistance

Patient trigger

If a patient trigger is detected, an illustration of the diaphragmatic muscle appears briefly at the beginning of inspiration, as shown in Figure 8-21. This allows you to quickly see whether the breath is patient triggered.

Figure 8-21. Patient triggering (1) in Dynamic Lung

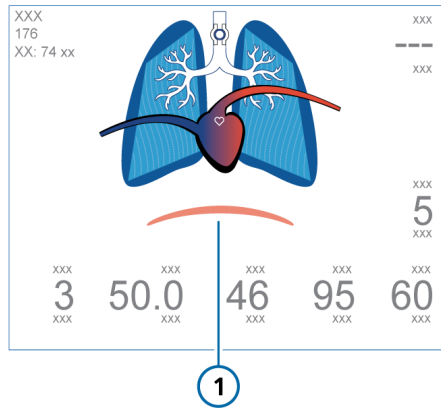

SpO2 data

If the SpO2 option is enabled and a sensor is connected, the **Dynamic Lung** panel shows a heart and big vessel illustration superimposed on the lungs. The heart beats in synchrony with the patient’s pulse rate. See Figure 8-18.

For details about SpO2 measurement, see the *Pulse Oximetry Instructions for Use*.

IntelliCuff data

When an IntelliCuff cuff pressure controller is connected to the ventilator, the **Dynamic Lung** displays the **Pcuff** parameter.

When IntelliCuff is connected, turned on, and active, the **Dynamic Lung** also includes a cuff symbol in the bronchial tree (Figure 8-18); this symbol also indicates the IntelliCuff-related alarm status (see Table 12-7).

8.4.1.1 Displaying the Dynamic Lung

The **Dynamic Lung** panel can be displayed in layouts 2 and 3, and in full display mode in layout 4 (Table 8-2).

To display the Dynamic Lung

1. Touch the area of the display where you wish to show the Dynamic Lung panel (Section 8.3.1).
2. In the graphics selection window, touch the **Graphics** tab (Figure 8-8).
3. Touch **Dynamic Lung**.

The window closes and the Dynamic Lung panel is displayed.

Figure 8-22. Dynamic Lung in display

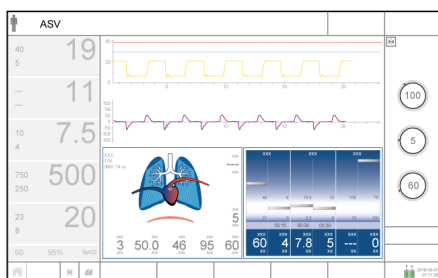

To select the full-display Dynamic Lung

1. Touch **Graphics**.
2. Select Layout 4 (Figure 8-6).

The window closes and the Dynamic Lung panel fills the display (Figure 8-23).

Figure 8-23. Dynamic Lung, full display

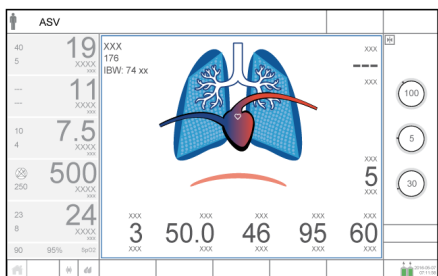

8.4.2 Vent Status panel: real-time ventilator dependence status

The Vent Status panel (Figure 8-24) displays six parameters related to the patient's ventilator dependence, in the areas of oxygenation, CO2 elimination, and patient activity.

A floating indicator moving up and down within the column shows the value for a given parameter.

When the indicator is in the white (weaning) zone, a timer starts, showing how long that value has been in the weaning zone. When all values are in the weaning zone, the Vent Status panel is framed in green, indicating that weaning should be considered. A timer appears, recording the length of time all values have been in the weaning zone (Figure 8-24).

The panel is updated breath by breath.

Table 8-3 describes the parameters shown in the Vent Status panel.

You can configure the weaning zone ranges for these parameters in Configuration. To set the values, see Section 14.6.1.

Figure 8-24. Vent Status panel

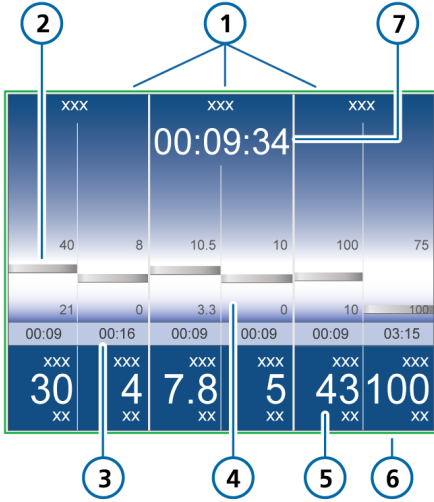

- | | |
|---|---|
| 1 Group title | 5 Monitored value, numeric |
| 2 Monitored value, graphic (floater) | 6 Green outline indicating all values are in the weaning zone |
| 3 Elapsed time value has been in weaning zone | 7 Elapsed time all values have been in weaning zone |
| 4 Weaning zone with user-configurable limits | |

Table 8-3. Vent Status parameters

Parameter (unit)	Definition
<i>For additional details, including ranges and accuracy, see Table 16-5.</i>	
Oxygen (%)	Oxygen setting.
PEEP (cmH2O)	PEEP/CPAP setting.
MinVol (l/min)	Normal minute ventilation (see Section 7.9).
Δ P _{insp} (cmH2O)	Inspiratory pressure, the target pressure (additional to PEEP/CPAP) applied during the inspiratory phase.
RSB (1 / (l*min)) ⁵⁹	Rapid shallow breathing index. The total breathing frequency (f _{Total}) divided by the exhaled tidal volume (VTE).
%fSpont (%)	Spontaneous breath percentage. The moving average of the percentage of spontaneous breaths over the last 10 total breaths.

⁵⁹ Weaning zone defaults are based on normal values < 100 / (l*min) for adult patients. Default values can be changed in Configuration.

8.4.2.1 Displaying the Vent Status panel

The **Vent Status** panel can be displayed in layouts 2 and 3 (Table 8-2).

To display the Vent Status panel

1. Touch the area of the display where you wish to show the **Vent Status** panel (Section 8.3.1).
2. In the graphics selection window, touch the **Graphics** tab (Figure 8-8).
3. Touch **Vent Status**.

The **Vent Status** panel is displayed (Figure 8-24).

8.4.3 ASV Graph panel: real-time patient condition and targets

Available in ASV⁶⁰ mode, the **ASV Graph** shows how the adaptive lung controller moves toward its targets. The graph shows both the target and real-time patient data for tidal volume, frequency, pressure, and minute ventilation.

Figure 7-18 in Chapter 7 describes the graph in detail.

8.4.3.1 Displaying the ASV Graph

The **ASV Graph** can be displayed in layouts 2 and 3 (Table 8-2).

To display the ASV Graph

1. Touch the area of the display where you wish to show the **ASV Graph** (Section 8.3.1).
2. In the graphics selection window, touch the **Graphics** tab (Figure 8-8).
3. Touch **ASV Graph**.

The **ASV Graph** is displayed (Figure 8-25).

Figure 8-25. ASV Graph panel (1)

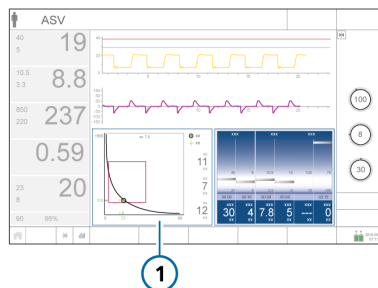

8.5 Monitoring transpulmonary/esophageal pressure

The **Pes** port allows you to use pressure readings other than airway pressure (**Paw**), for example, from an esophageal balloon catheter, for monitoring purposes. Using a combination of the **Paw** and **Pes** pressures, transpulmonary pressure is also calculated.

For connection details, see Section 3.5.

Once connected, the following parameter values are displayed in the **Monitoring > Pes** window (Figure 8-26): **Pes max**, **Pes plateau**, **Pes min**, **Pes P0.1**, **Pes PTP**, **Ptrans I**, and **Ptrans E** (see Table 8-4 for descriptions).

Pes and **Ptranspulm** values can also be viewed as waveforms (Section 8.3.3), loops (Section 8.3.5), and graphs in **P/V Tool** (Section 11.6).

⁶⁰ Only for adult/pediatric patients.

Figure 8-26. Monitoring > Pes window

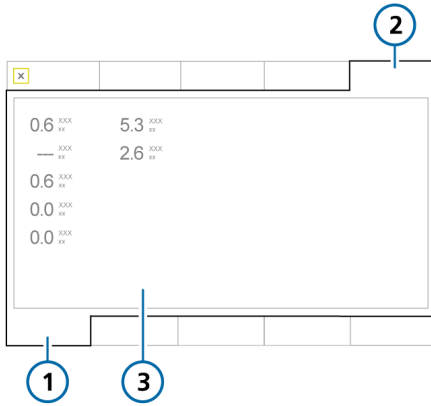

1 Monitoring

3 Pes-related parameter values

2 Pes

8.6 About the monitored parameters

The following table provides a list of the ventilator's monitored parameters.

You can review all parameter values in the **Monitoring** window (Section 8.2.3). The display of monitored parameters is updated every breath or is time driven.

See Section 16.6 for parameter specifications.

For details about SpO₂-related parameters, see the *Pulse Oximetry Instructions for Use*.

Table 8-4. Monitored parameters

Parameter (unit)	Definition
Pressure	
AutoPEEP (cmH ₂ O)	<p>The difference between the set PEEP and the calculated total PEEP within the lungs.</p> <p>AutoPEEP is the abnormal pressure generated by air “trapped” in the alveoli due to inadequate lung emptying. Ideally, it should be zero. AutoPEEP is calculated using the LSF method applied to the entire breath.</p> <p>Actively breathing patients can create artifacts or noise, which can affect the accuracy of these measurements.</p> <p>When AutoPEEP is present, volutrauma or barotrauma might develop. In active patients, AutoPEEP may present an extra workload to the patient.</p> <p>AutoPEEP or air trapping may result from an expiratory phase that is too short, which may be observed under the following conditions:</p> <ul style="list-style-type: none"> • Delivered tidal volume too large • Expiratory time too short or respiratory rate too high • Circuit impedance too high or expiratory airway obstruction • Peak expiratory flow too low
Driving pressure, ΔP (cmH ₂ O)	A calculated value showing the ratio of tidal volume to static compliance, which reflects the difference between P _{plateau} and PEEP.
PEEP/CPAP (cmH ₂ O)	<p>Monitored PEEP/CPAP. The airway pressure at the end of exhalation.</p> <p>Measured PEEP/CPAP may differ slightly from the set PEEP/CPAP, especially in spontaneously breathing patients.</p>
Pes max ⁶¹	See P _{peak} . The pressure is measured through the Pes port instead of using airway pressure.
Pes min ⁶¹	See PEEP. The pressure is measured through the Pes port instead of using airway pressure.
Pes P0.1 ⁶¹	See P0.1. The pressure is measured through the Pes port instead of using airway pressure.
Pes plateau ⁶¹	See P _{plateau} . The pressure is measured through the Pes port instead of using airway pressure.
Pes PTP ⁶¹	See PTP. The pressure is measured through the Pes port instead of using airway pressure.

⁶¹ Data is available only when an esophageal catheter is connected to the Pes port on the ventilator.

Parameter (unit)	Definition
ΔP_{insp} (cmH ₂ O)	<p>Inspiratory pressure, the automatically calculated target pressure (additional to PEEP) applied during the inspiratory phase.</p> <p>Also displayed in the Vent Status panel.</p> <p>Not all modes use the ΔP_{insp} parameter. Rather, this target pressure is set using the following parameters, depending on the selected mode:</p> <ul style="list-style-type: none"> • APVcmv, APVsimv, ASV: Automatically calculated target pressure • PCV+: $\Delta P_{\text{control}}$ setting • PSIMV+, NIV-ST, nCPAP-PS: ΔP_{insp} setting • SPONT, NIV: $\Delta P_{\text{support}}$ setting • APRV, DuoPAP: P high setting
P_{mean} (cmH ₂ O)	<p>Mean airway pressure. The absolute pressure, averaged over the breath cycle.</p> <p>P_{mean} is an important indicator of the possible impact of applied positive pressure on hemodynamics and surrounding organs.</p>
P_{peak} (cmH ₂ O)	<p>Peak airway pressure. The highest pressure during the previous breath cycle.</p> <p>It is influenced by airway resistance and compliance. P_{peak} may differ noticeably from alveolar pressure if airway resistance is high. This value is always displayed.</p> <p>P_{peak} is also used by IntelliCuff to control cuff pressure in Auto mode. For details, see Section 12.2.3.</p>
P_{plateau} (cmH ₂ O)	<p>Plateau or end-inspiratory pressure. The pressure measured at the end of inspiration when flow is at or close to zero.</p> <p>Used as a rough representation of alveolar pressure. P_{plateau} is displayed for mandatory and time-cycled breaths.</p>
P_{prox} (cmH ₂ O)	<p>The airway pressure at the proximal patient interface.</p> <p>Displayed only in HiFlowO2 when a flow sensor is connected.</p>
$P_{\text{trans}} E^{61}$	<p>Calculated from the $P_{\text{transpulm}}$ waveform. The arithmetic mean value of $P_{\text{transpulm}}$ over the last 100 ms of the last expiration.</p>
$P_{\text{trans}} I^{61}$	<p>Calculated from the $P_{\text{transpulm}}$ waveform. The arithmetic mean value of $P_{\text{transpulm}}$ over the last 100 ms of the last inspiration.</p>
Flow	
Flow ⁶² (l/min)	<p>The flow of gas to the patient when using HiFlowO2.</p>

⁶² Only displayed as an MMP; not displayed in the Monitoring window.

Parameter (unit)	Definition
Exp Flow (l/min)	Peak expiratory flow.
Insp Flow (l/min)	Peak inspiratory flow, spontaneous or mandatory. Measured every breath.
Volume	
ExpMinVol MinVol NIV (l/min)	Expiratory minute volume. The moving average of the monitored expiratory volume per minute over the last 8 breaths. ExpMinVol changes to MinVol NIV in noninvasive modes. MinVol NIV is an adjusted parameter taking leakage into account.
MVSpont MVSpont NIV (l/min)	Spontaneous expiratory minute volume. The moving average of the monitored expiratory volume per minute for spontaneous breaths, over the last 8 mandatory and spontaneous breaths. In noninvasive ventilation modes, MVSpont is replaced by MVSpont NIV . MVSpont NIV is an adjusted parameter taking leakage into account.
VLeak (%) MVLeak (l/min)	Due to the leakage at the patient interface, displayed exhaled volumes in the noninvasive modes can be substantially smaller than the delivered volumes. The flow sensor measures the delivered volume and the exhaled tidal volume; the ventilator displays the difference as VLeak in % and as MVLeak in l/min, averaged over the past 8 breaths. VLeak/MVLeak can indicate leaks on the patient side of the flow sensor. They do not include leakage between the ventilator and the flow sensor. Use VLeak and MVLeak to assess the fit of the mask or other noninvasive patient interface.
VTE VTE NIV (ml)	Expiratory tidal volume, the volume exhaled by the patient. It is determined from the flow sensor measurement, so it does not show any volume added due to compression or lost due to leaks in the breathing circuit. If there is a gas leak on the patient side, the displayed VTE may be less than the tidal volume the patient actually receives. In noninvasive ventilation modes, VTE is replaced by VTE NIV . VTE NIV is an adjusted parameter taking leakage into account.
VTESpont (ml)	Spontaneous expiratory tidal volume, the volume exhaled by the patient. If there is a gas leak on the patient side, the displayed VTESpont may be less than the tidal volume the patient actually receives. Only displayed for spontaneous breaths.

Parameter (unit)	Definition
VTI (ml)	Inspiratory tidal volume, the volume delivered to the patient, determined from the flow sensor measurement. If there is a gas leak on the patient side, the displayed VTI may be larger than the displayed VTE.
Vt/IBW Vt/Weight (kg)	Tidal volume is calculated according to ideal body weight (IBW) for adult/pediatric patients and according to the actual body weight for neonatal patients.
Time	
fControl (b/min)	Mandatory breath frequency. The moving average of machine-delivered breaths per minute over the last 8 total breaths.
fSpont (b/min)	Spontaneous breath frequency. The moving average of spontaneous breaths per minute over the last 8 total breaths.
fTotal (b/min)	Total breathing frequency. The moving average of the patient's total breathing frequency over the last 8 breaths, including both mandatory and spontaneous breaths. When the patient triggers a breath or the operator initiates a breath, fTotal may be higher than the Rate setting.
I:E	Inspiratory:expiratory ratio. Ratio of the patient's inspiratory time to expiratory time for every breath cycle. This includes both mandatory and spontaneous breaths. I:E may differ from the set I:E ratio if the patient breathes spontaneously.
TE (s)	Expiratory time. In mandatory breaths, TE is measured from the start of exhalation until the set time has elapsed for the switch to inspiration. In spontaneous breaths, TE is measured from the start of exhalation, as dictated by the ETS setting, until the patient triggers the next inspiration. TE may differ from the set expiratory time if the patient breathes spontaneously.

Parameter (unit)	Definition
TI (s)	<p>Inspiratory time.</p> <p>In mandatory breaths, TI is measured from the start of breath delivery until the set time has elapsed for the switch to exhalation.</p> <p>In spontaneous breaths, TI is measured from the patient trigger until the flow falls to the ETS setting for the switch to exhalation. TI may differ from the set inspiratory time if the patient breathes spontaneously.</p>
Other calculated and displayed parameters	
Cstat (ml/cmH ₂ O)	<p>Static compliance of the respiratory system, including lung and chest wall compliances, calculated using the LSF method. Cstat can help diagnose changes in elastic characteristics of the patient's lungs.</p> <p>Actively breathing patients can create artifact or noise, which can affect the accuracy of these measurements.</p>
Oxygen (%)	<p>Oxygen concentration of the delivered gas. It is measured by an O₂ sensor in the inspiratory pneumatics.</p> <p>This parameter is not displayed if the O₂ sensor is not installed, is defective, is not a genuine Hamilton Medical part, or if oxygen monitoring is disabled.</p>
P0.1 (cmH ₂ O)	<p>Airway occlusion pressure. The pressure drop during the first 100 ms when a breath is triggered. P0.1 indicates the patient's respiratory drive and patient inspiration effort.</p> <p>P0.1 applies only to patient-triggered breaths.</p> <p>A P0.1 value of -3 cmH₂O indicates a strong inspiratory effort, and a value of -5 cmH₂O indicates an excessive effort, possibly because the patient is "air hungry" (peak inspiratory flow or total ventilatory support is inadequate) or has an excessive drive.</p> <p>If P0.1 is below -3 cmH₂O:</p> <ul style="list-style-type: none"> • Increase pressure or volume settings (depending on mode) • Increase %MinVol (ASV mode only) • Shorten P-ramp

Parameter (unit)	Definition
PTP (cmH ₂ O*s)	<p>Inspiratory pressure time product.</p> <p>The measured pressure drop required to trigger the breath multiplied by the time interval until the PEEP/CPAP level is reached at the beginning of inspiration.</p> <p>PTP is valid for patient-initiated breaths only, and indicates work by the patient to trigger the breath. The work depends on:</p> <ul style="list-style-type: none"> • The intensity of the patient's effort • The trigger sensitivity • The volume and resistance of the breathing circuit <p>PTP does not indicate total patient work but is a good indicator of how well the ventilator is adjusted for the patient.</p> <p>If PTP values increase, do the following:</p> <ul style="list-style-type: none"> • Increase trigger sensitivity • Decrease P-ramp
RCexp (s)	<p>Expiratory time constant. The rate at which the lungs empty, as follows:</p> <p>Actual TE, % emptying</p> <p>1 x RCexp, 63%</p> <p>2 x RCexp, 86.5%</p> <p>3 x RCexp, 95%</p> <p>4 x RCexp, 98%</p> <p>RCexp is calculated as the ratio between VTE and flow at 75% of the VTE.</p> <p>Normal values in intubated adult patients:</p> <ul style="list-style-type: none"> • Short, < 0.6 seconds: restrictive disease (ARDS, atelectasis, chest wall stiffness) • Normal, 0.6 to 0.9 seconds: normal compliance and resistance, or combined decreased compliance and increased resistance • Long, > 0.9 seconds: obstructive disease (COPD, asthma), broncho-spasm, ET tube obstruction, or incorrect positioning <p>Use RCexp to set the optimum TE (Goal: TE ≥ 3 x RCexp):</p> <ul style="list-style-type: none"> • With passive patients: Adjust Rate and I:E • With active patients: Increase ΔPsupport and/or ETS to achieve a longer TE <p>These actions may reduce the incidence of AutoPEEP.</p>

Parameter (unit)	Definition
Rinsp (cmH ₂ O / (l/s))	<p>Resistance to inspiratory flow caused by the endotracheal tube and the patient's airways during inspiration.</p> <p>It is calculated using the LSF method applied to the inspiratory phase. Also displayed in the Dynamic Lung panel.</p> <p>Actively breathing patients can create artifact or noise, which can affect the accuracy of these measurements.</p>
RSB (1 / (l*min))	<p>Rapid shallow breathing index.</p> <p>The total breathing frequency (fTotal) divided by the exhaled tidal volume (VTE).</p> <p>Because a patient with dyspnea typically takes faster and shallower breaths than a non-dyspnoeic patient, RSB is high in the dyspnoeic patient and low in the non-dyspnoeic patient.</p> <p>RSB is often used clinically as an indicator of a ventilated patient's readiness for weaning.</p> <p>RSB is only significant for spontaneously breathing patients weighing more than 40 kg and is only shown if 80% of the last 25 breaths were spontaneous.</p>
Ventilation time	Displayed in the Controls > Patient window, shows how long the patient has been ventilated. For details, see Section 8.7.
IntelliCuff related	
Pcuff (cmH ₂ O)	<i>For IntelliCuff only. See Section 12.2.8.</i>
Humidifier related	
T y-piece (°C)	<i>For HAMILTON-H900 humidifier only. See Table 12-5.</i>
T humidifier (°C)	<i>For HAMILTON-H900 humidifier only. See Table 12-5.</i>
CO₂ related	
FetCO ₂ (%)	<p>Fractional end-tidal CO₂ concentration.</p> <p>Permits assessment of PaCO₂ (arterial CO₂). Note that it is inaccurate in pulmonary embolism.</p> <p>Available when a CO₂ sensor is connected and enabled.</p>

Parameter (unit)	Definition
PetCO ₂ (mmHg)	<p>End-tidal CO₂ pressure.</p> <p>The maximum partial pressure of CO₂ exhaled during a tidal breath (just before the start of inspiration). It represents the final portion of air that was involved in the exchange of gases in the alveolar area, thus providing a reliable index of CO₂ partial pressure in the arterial blood under certain circumstances.</p> <p>PetCO₂ does not reflect PaCO₂ in the case of a pulmonary embolism.</p> <p>When PetCO₂ is < 10, the quality index is red and the CO₂ poor signal alarm is generated.</p> <p>Available when a CO₂ sensor is connected and enabled.</p>
slopeCO ₂ (%CO ₂ /l)	<p>Slope of the alveolar plateau in the PetCO₂ curve, indicating the volume/flow status of the lungs.</p> <p>Available when a CO₂ mainstream sensor is connected and enabled.</p>
V'alv (ml/min)	<p>Alveolar minute ventilation.</p> <p>Permits assessment of actual alveolar ventilation (as opposed to minute ventilation).</p> <p>$V_{alv} * f$ (normalized to 1 minute)</p> <p>Available when a CO₂ mainstream sensor is connected and enabled.</p>
V'CO ₂ (ml/min)	<p>CO₂ elimination.</p> <p>Net exhaled volume of CO₂ per minute. Permits assessment of metabolic rate (for example, it is high with sepsis) and treatment progress.</p> <p>Available when a CO₂ mainstream sensor is connected and enabled.</p>
VDaw (ml)	<p>Airway dead space.</p> <p>Gives an effective, in-vivo measure of volume lost in the conducting airways. A relative increase in dead space points to a rise in respiratory insufficiency and can be regarded as an indicator of the current patient situation. Patients with high dead space values are at particular risk if the muscles also show signs of fatigue.</p> <p>Available when a CO₂ mainstream sensor is connected and enabled.</p>
VDaw/VTE (%)	<p>Airway dead space fraction at the airway opening.</p> <p>Available when a CO₂ mainstream sensor is connected and enabled.</p>
VeCO ₂ (ml)	<p>Exhaled CO₂ volume, updated breath by breath.</p> <p>Available when a CO₂ mainstream sensor is connected and enabled.</p>

Parameter (unit)	Definition
ViCO2 (ml)	Inspired CO2 volume, updated breath by breath. Available when a CO2 mainstream sensor is connected and enabled.
Vtalv (ml)	Alveolar tidal ventilation. VTE - VDaw Available when a CO2 mainstream sensor is connected and enabled.

8.7 Viewing patient ventilation time

The **Controls > Patient** window displays a timer that shows how long the patient has been ventilated.

Figure 8-27. Ventilation time

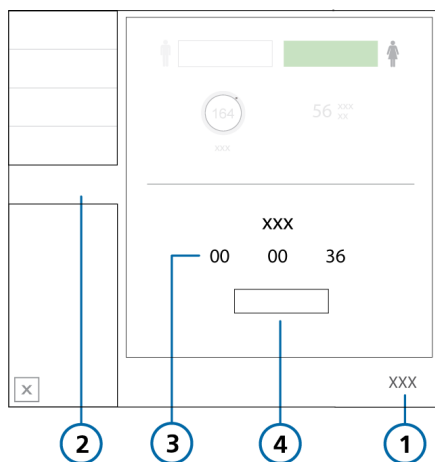

- | | |
|------------|---|
| 1 Controls | 3 Ventilation time
(days, hours,
minutes) |
| 2 Patient | 4 Reset |

The timer records time as follows:

- The timer starts when you start ventilation.
- When you enter **Standby**, the timer pauses. It picks up again from the last value when you exit **Standby** and return to active ventilation.
- When you set up a new patient in the **Standby** window, and start ventilation, the timer resets to 0.
- When you select **Last patient** in the **Standby** window, the timer continues from the last total time recorded.
- When you touch **Reset**, the timer resets to 0.

When the timer is reset, an entry is made to the **Event log** recording the time of the reset, as well as how long the ventilator had been running prior to the reset.

To reset the timer to 0

1. Touch **Controls**.
2. In the **Controls** window, touch the **Patient** tab.
3. Touch **Reset**.

The timer starts again at 00d 00h 00min.

8.8 Viewing device-specific information

The **System > Info** windows display device-specific information as follows:

System > Info 1 displays serial number, model, software version, operating hours, hours since startup, and battery status.

System > Info 2 displays communication board details and information about connected devices.

System > Info 3 displays the installed options.

To view device-specific information

1. Touch **System**.
2. Touch the desired **Info** tab.

9

Responding to alarms

9.1	Overview.....	196
9.2	About the alarm buffer	203
9.3	Adjusting alarm loudness (volume)	204
9.4	Troubleshooting alarms	205
9.5	Working with a distributed alarm system (DAS)	225

9.1 Overview

Operator-adjustable and nonadjustable alarms together with a visual alarm indicator notify you of conditions that require your attention.

These alarms are categorized as high, medium, or low priority, as described in Table 9-1. The ventilator's visual alarm indications are described in Figure 9-1.

Additional alarms conditions are associated with technical fault and technical note alarms, as well as informational messages.

You can view active alarms in the **alarm buffer** (Figure 9-2). Information about the alarm is also stored in the **Event log**.

Alarms are indicated in the color associated with the alarm priority as follows:

- The alarm lamp on top of the monitor lights and flashes.
- The message bar on the ventilator display is shown in color and displays the alarm text.
- An MMP associated with an active alarm is shown in color, together with a colored bar to the right of the affected parameter. The affected alarm limit is also shown in the associated color.
- In the **Monitoring** window, a parameter associated with an active alarm is shown in the associated color.
- Any affected parameter shown in the **Dynamic Lung** is shown in color.
- The **IntelliCuff** and **Humidifier** quick access icons are shown in the associated color when a related alarm is active.

- The alarm text is displayed in the **alarm buffer**.
- The **alarm status** indicator on the front of the ventilator body flashes red when an alarm is generated. See Section 2.2.1.1.

When an alarm condition is serious enough to possibly compromise safe ventilation, the device defaults to the **Ambient** state (Section 7.7). The inspiratory valve closes, and the ambient and expiratory valves are opened, letting the patient breathe room air unassisted.

If communication between the ventilator monitor (referred to as the *interaction panel* in alarm messages) and the ventilator unit is disrupted, the status indicators on the front of the ventilator body provide a visual indication of the ventilator status. For details about the indicators, see Table 2-3.

When reviewing alarms, you can access on-screen alarm troubleshooting help in the **Alarms > Buffer** window. See Section 9.2.1.

For details on setting alarm limits, see Section 5.6.

Table 9-1 describes the audio and visual characteristics of these types of alarms and provides guidance on how to respond.

Table 9-1. Alarm indicators

Alarm type	Message bar	Alarm lamp / Alarm status indicator	Audio	Action required
High priority	Red, with alarm message	Red, flashing Alarm status indicator on the front of the ventilator body flashes	A sequence of 5 beeps, repeated until the alarm is reset.	The patient's safety is compromised. The problem needs immediate attention.
Medium priority	Yellow, with alarm message	Yellow, flashing Alarm status indicator on the front of the ventilator body flashes	A sequence of 3 beeps, repeated periodically.	The patient needs prompt attention. For most alarms, press the Audio pause key to reset the alarm. For some alarms, reset the alarm by opening the alarm buffer (touch the message bar or the Audio pause indicator at the bottom right of the display).
Low priority	Yellow, with alarm message	Yellow, solid Alarm status indicator on the front of the ventilator body flashes	Two sequences of beeps. This is not repeated.	For most alarms, press the Audio pause key to reset the alarm. For some alarms, reset the alarm by opening the alarm buffer (touch the message bar or the Audio pause indicator at the bottom right of the display).

Alarm type	Message bar	Alarm lamp / Alarm status indicator	Audio	Action required
Panel communication error	<p>Communication error between ventilator monitor and unit. No message can be displayed.</p> <p>For details, see Section 7.7.4.</p>	<p>Alarm status indicator on the front of the ventilator body flashes</p>	<p>Continuous buzzer tone after a 30-second delay.</p> <p>The buzzer cannot be silenced.</p>	<p>Check the Lung status indicator on the front of the ventilator body (Section 2.2.1.1).</p> <p>If it is flashing, ventilation continues until you turn off the device. If it is not flashing, no ventilation is being delivered.</p> <ul style="list-style-type: none"> • Immediately provide alternative ventilation. • Turn off the ventilator by pressing the Power/Standby button on the back of the device for 10 seconds. • Have the ventilator serviced.

Alarm type	Message bar	Alarm lamp / Alarm status indicator	Audio	Action required
Panel connection lost	<p>An error has occurred with the ventilator monitor.</p> <p>If the display is still visible, the Panel error mode window is shown.</p> <p>For details, see Section 7.7.4.</p>	<p>Alarm status indicator on the front of the ventilator body flashes</p>	<p>Continuous buzzer tone.</p> <p>The buzzer cannot be silenced.</p>	<p>Check the Lung status indicator on the front of the ventilator body (Section 2.2.1.1).</p> <p>If it is flashing, ventilation continues until you turn off the device. If it is not flashing, no ventilation is being delivered.</p> <ul style="list-style-type: none"> • Immediately provide alternative ventilation. • Turn off the ventilator by pressing the Power/Standby button on the back of the device for 10 seconds. • Have the ventilator serviced.
Technical fault	<p>Red, with the text, <i>Safety ventilation, Safety therapy, or Technical fault: xxxxxx</i></p>	<p>Red, flashing Alarm status indicator on the front of the ventilator body flashes</p>	<p>Same as for high-priority alarm, if technically possible. At a minimum, a continuous buzzer tone. The buzzer cannot be silenced.</p>	<p>The ventilator enters Safety ventilation, or, if it cannot safely ventilate, the Ambient state.</p> <ul style="list-style-type: none"> • Provide alternative ventilation. • Turn off the ventilator. • Have the ventilator serviced.

Alarm type	Message bar	Alarm lamp / Alarm status indicator	Audio	Action required
Technical event	Depends on severity of the event. Can be low, medium, or high.	Same as the associated alarm level	Same as the associated alarm level.	A technical alarm cannot typically be corrected by the operator. Ventilation continues. Have the ventilator serviced.
Technical note	Provides technical information about a hardware or software issue, displayed only in the Event log.	--	--	No action is required.

Figure 9-1. Visual alarm indications

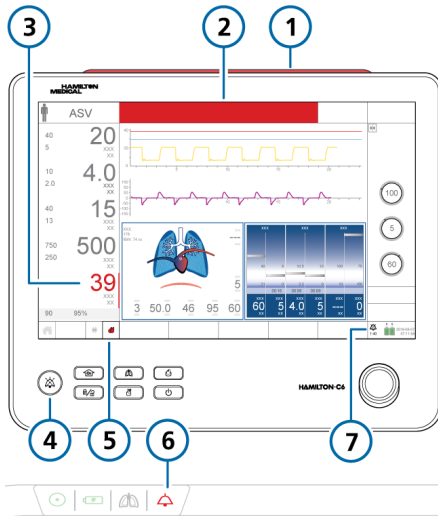

- | | |
|---|---|
| 1 Alarm lamp | 5 Humidifier icon associated with alarm |
| 2 Message bar | 6 Alarm status indicator flashes |
| 3 MMP and colored bar associated with alarm | 7 Audio pause indicator and count-down |
| 4 Audio pause key | |

9.1.1 Alarm limit indicators

Alarm limits are shown:

- In the Alarms > Limits windows
- On the main display to the left of the MMPs, when appropriate

When an alarm limit is disabled, that is, no limit applies, the device shows the following Alarm Off⁶³ symbol:



For details about setting alarm limits, see Section 5.6.

9.1.2 Responding to an alarm

WARNING

When an Audio pause is active, the following critical alarms still generate an audible alarm:

- Apnea
- Check flow sensor for water
- Loss of external power
- No ventilation after power fail
- Oxygen supply failed
- Panel connection lost
- Remote communication error
- Remote communication timeout
- SpO2 low
- Technical events: 231003, 243001, 243002, 283007, 284003, and 285003
- All technical faults

⁶³ Not available in all markets.

CAUTION

Carefully set alarm limits according to the patient's condition. Setting limits too high or too low defeats the purpose of the alarm system.

NOTICE

The factory default alarm limit settings are set in line with the selected patient group, allowing for unattended monitoring. These settings, however, can *never* replace individual review of the patient and adjustment of alarm limits based on their condition.

Alarms may result from either a clinical condition or an equipment issue. In addition, a single alarm condition can generate multiple alarms.

Your search for the causes of the alarm condition should be assisted by, but not limited to, the alarm messages displayed.

To respond to an alarm

1. Approach the patient immediately.
2. Secure sufficient and effective ventilation for the patient.

You can pause the audible alarm, if appropriate and available. See Section 9.1.3.

3. Correct the alarm condition from the alarm messages. See Section 9.4.

For most alarms, when the alarm triggering condition is corrected, the ventilator automatically resets the alarm. For some alarms, one more step is required: you must open the alarm buffer (touch the message bar or the **Audio pause** indicator at the bottom right of the display) to reset the alarm.

For a technical fault, remove the ventilator from use, note the fault code, and have the ventilator serviced.

4. If appropriate, readjust the alarm limit.

9.1.3 Temporarily silencing an alarm

One component of an alarm is the audible alarm sound. With most alarms, you can pause (silence) the alarm sound for two minutes at a time.

When the ventilator is used with a distributed alarm system, you can activate **global AUDIO OFF**, silencing most ventilator alarms for an unlimited period of time. For details about working with a distributed alarm system, see Section 9.5.

To temporarily silence an alarm

- ▶ Press  (**Audio pause**) on the front of the ventilator monitor.

The audible ventilator alarm is muted for two minutes. Pressing the key a second time cancels the **Audio pause**.

The **Audio pause** key backlight is continuously lit in red while an **Audio pause** is active.

The display also indicates an **Audio pause** is engaged as follows (Figure 9-1):

- The **Audio pause** indicator is displayed.
- A countdown timer on the main display shows the remaining time for the **Audio pause**.

When the time expires and the issue has not yet been resolved, an audible alarm sounds again.

9.2 About the alarm buffer

The alarm buffer shows up to 7 active alarm messages or up to 11 inactive alarm messages:

- The alarm buffer shows active alarms as they are generated (Figure 9-2). The alarm messages also alternate in the message bar. Active alarms are shown in wide color-coded boxes.
- If no alarms are active, the alarm buffer shows the most recent inactive alarms (Figure 9-3). Inactive alarms are shown in narrow color-coded boxes. In addition, the *i*-icon is visible on the display.
- Touch an alarm entry to view troubleshooting help directly on the display.

To view alarms

- ▶ Open the **Alarms > Buffer** window by doing one of the following:
 - Touch an active alarm in the message bar at the top of the display (Figure 9-2).
 - Touch the inactive alarm indicator (the *i*-icon) (Figure 9-3).
 - Touch the **Audio pause** indicator at the bottom right of the display (Figure 9-1).
 - Touch **Alarms > Buffer**.

The most recent alarm is at the top of the list.

To clear the list of inactive alarms

- ▶ Touch the **Reset** button (Figure 9-3). Closing the alarm buffer does not erase its contents.

Figure 9-2. Alarm buffer with active alarms

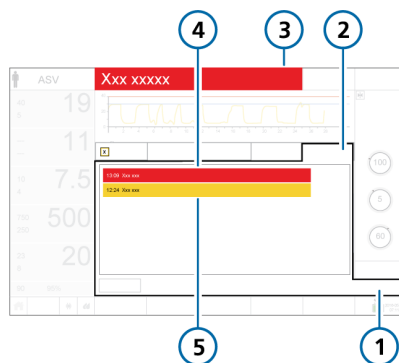

- | | |
|-----------------------------|--|
| 1 Alarms | 4 High-priority alarm (red) |
| 2 Buffer | 5 Low- or medium-priority alarm (yellow) |
| 3 Alarm text in message bar | |

Figure 9-3. Alarm buffer with inactive alarms

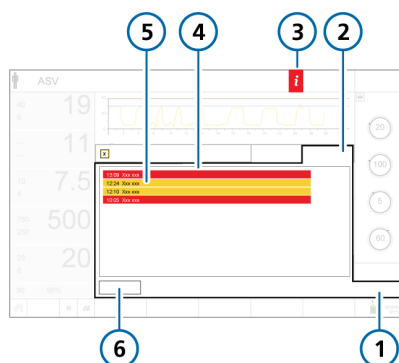

- | | |
|------------------|---|
| 1 Alarms | 4 Inactive high-priority alarm (red) |
| 2 Buffer | 5 Inactive low- or medium-priority alarm (yellow) |
| 3 <i>i</i> -icon | 6 Reset |

9.2.1 Accessing on-screen troubleshooting help

Troubleshooting help is available for alarms.

To view the help for an alarm

1. Touch the alarm message in the buffer.

A **Help** window appears in the buffer, providing troubleshooting information for the selected alarm.

2. To view help for another alarm, touch the next alarm message.

The contents of the **Help** window refresh with the new information.

The alarm is displayed as long as the window is open even if the alarm is no longer active.

3. Touch **X** to close the **Help** window.

Figure 9-4. On-screen help window

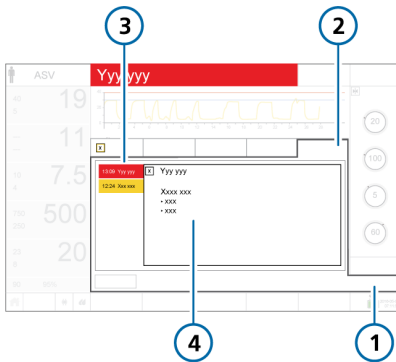

- | | |
|----------|--|
| 1 Alarms | 3 Selected alarm |
| 2 Buffer | 4 Alarm text and troubleshooting information |

9.3 Adjusting alarm loudness (volume)

⚠ WARNING

Be sure to set the auditory alarm loudness above the ambient sound level. Failure to do so can prevent you from hearing and recognizing alarm conditions.

You can set the loudness of the audible alarm.

By default, the loudness is set to 5 (**Adult/Ped**) or 3 (**Neonatal**).

If you set the loudness below the default value during a patient session, the value is reset to the default upon:

- Setting up a new patient
- Turning the ventilator off and on again

You cannot set the loudness below the minimum level configured for the device (Chapter 14).

To adjust the alarm loudness

1. Touch **System** > **Settings**.
2. Touch the **Loudness** button if the **Loudness** window is not already displayed.
3. Activate and adjust the **Loudness** control, as needed.
4. Touch **Test** to check the loudness level.

Ensure the loudness level is above the ambient sound level.

5. Repeat the process as required, and close the window.

Figure 9-5. Alarm loudness control

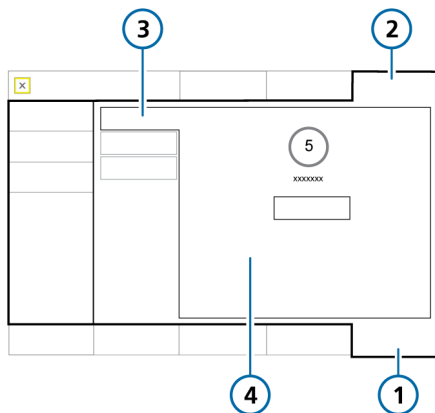

- | | |
|------------|------------------------------------|
| 1 System | 3 Loudness |
| 2 Settings | 4 Loudness control and Test button |

For additional alarm information, see the appropriate documentation as follows:

- For SpO2-related alarms, see the *Pulse Oximetry Instructions for Use*.
- For INTELLiVENT-ASV-related alarms, see the *INTELLiVENT-ASV Operator’s Manual*.
- For HAMILTON-H900-related alarms, see Section 12.1.6 and the *HAMILTON-H900 Instructions for use*.
- For IntelliCuff-related alarms, see Section 12.2.7 and the *IntelliCuff Instructions for use*.

9.4 Troubleshooting alarms

Table 9-2 is an alphabetical list of the alarm messages displayed by the HAMILTON-C6, along with their definitions and suggested corrective actions.

These corrective actions are sequenced to correct the most probable issue or to present the most efficient corrective action first. The proposed actions, however, may not always correct the particular problem.

If your issue is not resolved after performing the recommended tasks, contact your Hamilton Medical authorized service personnel.

Table 9-2. Alarms and other messages

Alarm	Definition	Action needed
Aerogen nebulizer disconnected	<p><i>Medium priority.</i> Any of the following conditions apply during active ventilation and nebulization:</p> <p>Aerogen is the selected nebulizer type and the countdown timer is running, but:</p> <ul style="list-style-type: none"> • A nebulizer is not connected • The nebulizer is not properly connected and is not being powered 	<ul style="list-style-type: none"> • Verify that an Aerogen nebulizer is connected to the breathing circuit set. • Check the connection of the nebulizer to the Aerogen port on the ventilator. • If the problem still persists, have the ventilator serviced.
Ambient state	The inspiratory and expiratory channels are opened, letting the patient breathe room air unassisted. See Section 7.7.	Provide alternative ventilation immediately.
Apnea ventilation ended	<i>Low priority.</i> Backup mode was reset, and ventilator is again ventilating in its original support (pre-apnea) mode.	No action required.
Apnea ventilation	<i>Low priority.</i> Apnea backup ventilation has started. No breath delivered for the operator-set apnea time. Apnea backup ventilation is on.	<ul style="list-style-type: none"> • Check patient condition. • Check trigger sensitivity. • Check the control settings for the backup mode. • Consider changing the mode.
Apnea	<i>High priority.</i> No patient trigger within the operator-set apnea time in (S)CMV, SIMV, APVsimv, DuoPAP, APRV, SPONT, NIV, NIV-ST, or nCPAP-PS mode. Apnea backup is off.	<ul style="list-style-type: none"> • Check patient condition. • Check trigger sensitivity. • Consider changing the mode.
ASV: Cannot meet target	<i>Low priority.</i> The operator-set %MinVol cannot be delivered, possibly due to setting conflicts or lung-protective rules.	<ul style="list-style-type: none"> • Check patient condition. • Check the Plimit setting and adjust if appropriate. • Consider a mode change. However, be aware that other modes may not enforce lung-protective rules.

Alarm	Definition	Action needed
Battery 1, 2: Calibration required	<i>Low priority.</i> The battery requires calibration. You may continue to use the battery.	Replace the battery with a properly calibrated battery to continue ventilation.
Battery 1, 2: Defective	<i>High priority.</i> Battery is defective. Ventilation continues if an alternative power source is connected.	<ul style="list-style-type: none"> • Replace battery. • Prepare alternative ventilation. • If the problem still persists, have the ventilator serviced.
Battery 1, 2: Replacement required	<i>Low priority.</i> Battery capacity is insufficient for reliable operation and must be replaced immediately.	<ul style="list-style-type: none"> • Connect the ventilator to primary power (AC). • Replace the battery. • If a replacement is not available, provide alternative ventilation until the issue is resolved. • If the problem still persists, have the ventilator serviced.
Battery 1, 2: Temperature high	<i>High priority.</i> The battery temperature is higher than expected.	<ul style="list-style-type: none"> • Remove the ventilator from the sun or other heat source. • Replace the battery. • Provide alternative ventilation until the issue is resolved. • If the problem still persists, have the ventilator serviced.
Battery 1, 2: Wrong battery	<i>Low priority.</i> The battery in use is not the correct battery for this ventilator.	<ul style="list-style-type: none"> • Replace the battery with the correct Li-ion battery. • Connect the ventilator to primary power (AC). • Provide alternative ventilation until the issue is resolved.
Battery communication error	<i>High priority.</i> Battery data is not available. Ventilation continues.	<ul style="list-style-type: none"> • Check the battery connectors and that the battery is installed correctly. • Make sure the battery lock is properly closed. • If the problem persists, replace the battery. • If the problem still persists, have the ventilator serviced.

Alarm	Definition	Action needed
Battery low	<p>The Battery low alarm has different levels of priority depending on battery age and condition. The alarm priority levels are defined as follows:</p> <p>High priority. The ventilator is running on battery power, and the battery charge is critically low. You have a minimum of 5 minutes operating time left.</p> <p>If the high-priority Battery low alarm occurs when starting up the ventilator, you may have less than 5 minutes of operating time remaining.</p> <p>Medium priority. The ventilator is running on battery power and the battery charge is low.</p>	<ul style="list-style-type: none"> • Connect the ventilator to a primary power source. • Install charged battery. • If necessary, be prepared to provide alternative ventilation.
Battery power loss	<p><i>High priority.</i> No battery is present.</p>	<ul style="list-style-type: none"> • Connect the ventilator to primary power (AC). • Insert a battery.
Battery totally discharged	<p><i>High priority.</i> The battery charge level is below 5%. The ventilator switches to the Ambient state.</p>	<ul style="list-style-type: none"> • Connect the ventilator to primary power (AC). Connecting to primary power also charges the battery. • Immediately provide alternative ventilation until the issue is resolved. • If the problem still persists, have the ventilator serviced.
Blower fault	<p><i>High priority.</i> A blower malfunction was detected. A technical alarm cannot typically be corrected by the operator. The ventilator switches to the Ambient state.</p>	<ul style="list-style-type: none"> • Immediately provide alternative ventilation. • Have the ventilator serviced.
Blower service required	<p><i>Low priority.</i> Blower has reached the end of its lifespan.</p>	<p>Have the ventilator serviced.</p>

Alarm	Definition	Action needed
Buzzer defective	<i>High priority.</i> A buzzer malfunction was detected. A technical alarm cannot typically be corrected by the operator.	<ul style="list-style-type: none"> Restart device. Provide alternative ventilation until the issue is resolved. If the problem persists, have the ventilator serviced.
Check CO2 airway adapter	<i>Low priority.</i> Adapter disconnection, optical block, or adapter type changed.	<ul style="list-style-type: none"> Check patient condition. Check the airway adapter for excess moisture accumulation /contamination by secretions. Replace / perform zero calibration on airway adapter.
Check CO2 sampling line	<i>Low priority.</i> The CO2 sidestream sensor sampling line is occluded by water.	<ul style="list-style-type: none"> Check patient condition. Replace sampling line.
Check flow sensor for water ⁶⁴	<p><i>Neonatal only.</i> Water is detected inside the flow sensor, which is affecting measurements.</p> <p><i>Medium priority.</i> You must acknowledge the alarm within 90 seconds by pressing the Audio pause key. This gives you time to remove any accumulated water from the flow sensor and tubing.</p> <p><i>High priority.</i> If the alarm is not acknowledged within 90 seconds, the alarm becomes high priority. The alarm is active until flow sensor measurements are again within the expected range.</p> <p>You can specify alarm sensitivity or disable the alarm in Configuration. See Section 14.3.5.</p>	<ul style="list-style-type: none"> Remove all water from the flow sensor and flow sensor tubing. You <i>must</i> position the flow sensor at a $\geq 45^\circ$ angle to avoid water accumulation. Adjust the FS alarm sensitivity control.

⁶⁴ Not available in all markets.

Alarm	Definition	Action needed
Check flow sensor	<p><i>High priority.</i> Flow sensor measurements are out of the expected range.</p> <p>If the alarm continues for 3 consecutive breath cycles, the External flow sensor failed alarm is generated and the ventilator switches to Sensor Failure mode (Section 7.7.1).</p>	<ul style="list-style-type: none"> • Make sure the flow sensor is the correct type for the patient (Adult/ Ped or Neonatal). • Check the flow sensor connection to the ventilator. • Connect and calibrate a new flow sensor.
Check flow sensor tubing	<p><i>High priority.</i> The flow sensor tubes are disconnected or occluded.</p> <p>If the alarm continues for 3 consecutive breath cycles, the External flow sensor failed alarm is generated and the ventilator switches to Sensor Failure mode (Section 7.7.1).</p>	<ul style="list-style-type: none"> • Check the flow sensor connection to the ventilator. • Connect and calibrate a new flow sensor.
Check for blockage	<p><i>Medium priority.</i> Internal pressure is above 45 cmH₂O in HiFlowO2.</p> <p><i>High priority.</i> If the pressure increases further and exceeds 50 cmH₂O, the alarm becomes high priority, flow stops, and the pressure is released.</p>	<ul style="list-style-type: none"> • Observe the patient • Check patient interface for blockage. <p>If no blockage is observed, consider reducing the flow to decrease pressure.</p> <ul style="list-style-type: none"> • Check breathing circuit limbs and tubing for kinks.
Check Plimit	<p><i>Low priority.</i> Inspiratory pressure, including PEEP/CPAP, is above the pressure limit (Plimit).</p> <p>Does not apply in APVcmv, APVsimv, or ASV modes.</p>	<ul style="list-style-type: none"> • Check the patient for adequate ventilation. • Adjust Plimit and/or the pressure control settings, as appropriate.
Check settings	<p><i>Low priority.</i> A change to a control or alarm setting was not saved.</p>	<p>Check and confirm settings, including alarms.</p>

Alarm	Definition	Action needed
CO2 sensor calibration needed	<i>Low priority.</i> A previous sensor zero calibration failed.	Perform the following checks, repeating the calibration after each one, until calibration is successful: <ul style="list-style-type: none"> • Clean or replace airway adapter. • Perform a zero calibration of the sensor, making sure there is no source of CO2 near the airway adapter. • Replace the airway adapter. • Replace the CO2 sensor. • If the problem persists, have the ventilator serviced.
CO2 sensor defect	<i>Low priority.</i> CO2 sensor signal indicates a hardware error or a third-party sensor is installed.	<ul style="list-style-type: none"> • Disconnect the sensor from the CO2 module. Wait a few seconds, and reconnect. • Perform a zero calibration of the sensor. Ensure the sensor is attached to the airway adapter during zero calibration. • Replace the CO2 sensor. Make sure the sensor is a genuine Hamilton Medical part.
CO2 sensor disconnected	<i>Low priority.</i> The CO2 module is installed, but there is no signal from the CO2 sensor. CO2 monitoring is enabled.	<ul style="list-style-type: none"> • Make sure a CO2 sensor is connected. • Check CO2 sensor connections (CO2 sensor cable to module, CO2 module to ventilator). • If the problem persists, have the ventilator serviced.

Alarm	Definition	Action needed
CO2 sensor over temperature	<i>Low priority.</i> Temperature at the CO2 sensor too high.	<ul style="list-style-type: none"> • Check whether the sensor is affected by an external heating source. • Remove the sensor from the airway, and disconnect the sensor from the CO2 module. Reconnect. • Verify that system is running within the specified environmental conditions. Check for excessive airway temperature, which could be caused by defective humidifier, heater wire, or probe.
CO2 sensor warmup	<i>Low priority.</i> The CO2 operating temperature has not yet been reached or is unstable.	Wait for sensor to warm up.
CO2: Poor signal	<i>Low priority.</i> The CO2 sensor signal quality is poor. Also generated when PetCO2 < 10 mmHg.	<ul style="list-style-type: none"> • Check patient condition. • Check CO2 sensor and adapter connections. • Ensure that airway adapters are not in a horizontal position relative to the floor to reduce accumulation of patient secretions. If accumulation occurs, remove the adapter, rinse with water, and reconnect.
Continue charging battery	<i>Low priority.</i> The ventilator is running on primary power and the battery charge is low.	Continue charging the battery until the alarm is resolved.
Device temperature high	<i>High priority.</i> The internal temperature of the ventilator is higher than expected.	<ul style="list-style-type: none"> • Remove the ventilator from the sun or other heat source. • Check the cooling fan filter and fan. • Prepare alternative ventilation. • Have the ventilator serviced.

Alarm	Definition	Action needed
Disconnection on patient side	<p><i>High priority.</i> VTE is less than one-eighth of the delivered VTI, and delivered VTI exceeds 50 ml.</p> <p>Applicable in invasive modes. For APRV and DuoPAP modes, only applicable during the pressure phase.</p>	<ul style="list-style-type: none"> • Check patient condition. • Check the breathing circuit for a disconnection between the patient and the flow sensor, or for other large leaks (for example, ET tube).
Disconnection on ventilator side	<p><i>High priority.</i> Measured VTI at the flow sensor is less than one-half of the delivered VTI, and delivered VTI exceeds 50 ml.</p>	<ul style="list-style-type: none"> • Check the expiratory valve: <ul style="list-style-type: none"> – Check the condition of the expiratory valve set. If anything is defective, replace. – Check whether the expiratory valve is affected by any nebulizing agent. – Make sure that the expiratory valve is properly installed. – Check whether there is a disconnection at the expiratory valve. • Replace the expiratory valve. • Check the flow sensor. If needed, replace the flow sensor.
Exhalation obstructed	<p><i>High priority.</i> Either the end-expiratory pressure is too high or the end-expiratory flow is too low.</p> <p>Note that you must use an inspiratory filter to prevent contamination. The ventilator may be contaminated if no inspiratory filter is used.</p> <p>Not active during HiFlowO2.</p>	<ul style="list-style-type: none"> • Check patient condition. • Check the expiratory limb for occlusion. • Check the expiratory valve set. Replace if needed. • Check the flow sensor tubes for occlusion. • Adjust breath timing controls to increase the expiratory time. • Provide alternative ventilation until the issue is resolved. • Have the ventilator serviced.

Alarm	Definition	Action needed
External flow sensor failed	<p><i>High priority.</i> The external flow sensor does not work properly.</p> <p>The alarm is generated when either the Check flow sensor or Check flow sensor tubing alarm is active for 3 consecutive breath cycles. The ventilator switches to Sensor Failure mode (Section 7.7.1).</p>	<ul style="list-style-type: none"> • Check flow sensor for excessive secretions and/or water accumulation. • Provide alternative ventilation and clean the flow sensor with sterile water. • Connect and calibrate a new flow sensor.
Fan failure	<p><i>Medium priority.</i> There is a problem with the cooling fan.</p>	<ul style="list-style-type: none"> • Provide alternative ventilation until the issue is resolved. • Disconnect the ventilator from the patient. • Have the ventilator serviced.
Flip the flow sensor	<p><i>Medium priority.</i> Either the flow sensor is connected to the breathing circuit facing the wrong direction or the flow sensor connections to the ventilator are reversed.</p> <p>Ventilation continues, but the ventilator corrects for the reversed signal.</p>	<ul style="list-style-type: none"> • Check the flow sensor. The end marked PATIENT faces the patient. • Reverse the flow sensor tube connections on the ventilator. • The blue tube attaches to the blue connector. The clear tube attaches to the silver connector.
Flow sensor calibration needed	<p><i>High priority during ventilation, low in Standby.</i> The ventilator does not have correct calibration data or automatic recalibration of the flow sensor is impossible.</p> <p>In Standby, may indicate that the patient group has changed.</p> <p>Note that flow, volume, and pressure measurements are less accurate with an uncalibrated flow sensor.</p>	<ul style="list-style-type: none"> • Ensure the correct flow sensor for the selected patient group is attached to the breathing circuit. • Calibrate the flow sensor as soon as possible.
Function key not operational	<p><i>Medium priority.</i> Function key defective. Ventilation continues.</p>	<ul style="list-style-type: none"> • Turn off the ventilator using the Power/Standby button on the back of the device. • Have the ventilator serviced.

Alarm	Definition	Action needed
High frequency	<i>Medium priority.</i> The measured fTotal exceeds the set alarm limit.	<ul style="list-style-type: none"> • Check the patient for adequate ventilation (VTE). • Check alarm limits. • Check the trigger sensitivity. • If the ventilator is in ASV mode, see Section 7.9.
High minute volume	<i>High priority.</i> The measured ExpMinVol exceeds the set alarm limit.	<ul style="list-style-type: none"> • Check patient condition. • Check and confirm settings, including alarms.
High oxygen	<p><i>High priority.</i></p> <p>One of the following has occurred:</p> <ul style="list-style-type: none"> • If the Oxygen alarm limits are set automatically, the measured oxygen is more than 5% (absolute) above the current Oxygen control setting. • If the Set Oxygen alarm limits manually checkbox is selected in Configuration, the measured oxygen is above the set upper limit. 	<ul style="list-style-type: none"> • Calibrate the O2 sensor. • Install a new O2 sensor. • Check alarm limits (if set manually). • If using a paramagnetic O2 sensor, calibrate the sensor or have the ventilator serviced.
High PEEP	<p><i>Medium priority.</i> Monitored PEEP exceeds (set PEEP + 5 cmH2O) for two consecutive breaths.</p> <p><i>For DuoPAP and APRV only:</i> Alarm applies to both P high and P low settings. The alarm sounds when the monitored P high exceeds (set P high + 5 cmH2O) or monitored P low exceeds (set P low + 5 cmH2O) for two consecutive breaths.</p> <p>If T low is set to < 3 seconds, the High PEEP alarm is disabled for P low settings. This reduces the incidence of false positive alarms.</p>	<ul style="list-style-type: none"> • Check patient condition. • Check and confirm settings, including alarms. • Check the expiratory valve set for possible obstructions. • Check for obstructions in the expiratory limb.

Alarm	Definition	Action needed
High pressure during sigh	<i>High priority.</i> A sigh cannot be fully delivered because excessive inspiratory pressure would be required. The sigh is partially delivered.	<ul style="list-style-type: none"> • Check patient condition. • Check the artificial airway of the patient for kinks and occlusions. • Check the breathing circuit limbs and flow sensor tubes for kinks and occlusions. • Consider disabling the Sigh function.
High pressure	<p><i>High priority, Low after Audio pause is activated.</i> The measured inspiratory pressure exceeds the set high Pressure alarm limit. The ventilator immediately closes the inspiratory valve to stop gas flow to the patient and opens the expiratory valve to reduce pressure to the PEEP/CPAP level.</p> <p>If the pressure reaches 15 cmH₂O above the high Pressure alarm limit for longer than 5 seconds, the ventilator opens the release valve.</p> <p>If the pressure reaches 15 cmH₂O above the high Pressure alarm limit for longer than 7 seconds, the ventilator enters the Ambient state.</p>	<ul style="list-style-type: none"> • Check patient condition. • Adjust the Pressure alarm limit. • Check the artificial airway of the patient for kinks and occlusions. • Check the breathing circuit limbs and flow sensor tubes for kinks and occlusions. • Provide alternative ventilation once the ventilator enters the Ambient state.
Inspiratory volume limitation	<p><i>Medium priority.</i> The delivered Vt is more than 1.5 times the set high Vt alarm limit. Pressure is reduced to PEEP level.</p> <p>The APV controls reduce the pressure for the next breath by 3 cmH₂O.</p> <p>Disabled in noninvasive modes.</p>	<ul style="list-style-type: none"> • Reduce the ΔPsupport setting. • Adjust the high Vt alarm limit.
Invalid communication board	<i>Low priority.</i> The installed communication board is invalid.	<ul style="list-style-type: none"> • Contact your Hamilton Medical technical representative. • Have the ventilator serviced.

Alarm	Definition	Action needed
IRV	<p><i>Low priority.</i> The set I:E ratio is above 1:1, leading to inverse ratio ventilation.</p> <p>Does not apply in PSIMV+PSync, SPONT, NIV, or NIV-ST modes, or in HiFlowO2.</p>	<p>Check the timing control settings.</p>
Language not loaded	<p><i>Low priority.</i> The selected language data cannot be loaded.</p>	<ul style="list-style-type: none"> Restart device. If the problem persists, have the ventilator serviced.
Loss of external power	<p><i>Low priority.</i> The ventilator is running on battery power due to loss of a primary power source.</p>	<ul style="list-style-type: none"> Silence the alarm. Check integrity of connection to primary power source. Check battery status. Prepare for possible power loss. Provide alternative ventilation until the issue is resolved.
Loss of PEEP	<p><i>Medium priority.</i> One of the following conditions is in effect:</p> <ul style="list-style-type: none"> Pressure during exhalation is below (set PEEP/CPAP – 3 cmH2O) for more than 10 seconds Measured end-expiratory pressure is below (set PEEP/CPAP – 3 cmH2O) for two consecutive breaths 	<ul style="list-style-type: none"> Check patient condition. Check the breathing circuit for leaks. Replace the breathing circuit, if necessary. Check the condition of the expiratory valve set. If anything is defective, replace.
Loudspeaker defective	<p><i>High priority.</i> A loudspeaker malfunction was detected. A technical alarm cannot typically be corrected by the operator. Ventilation continues.</p>	<ul style="list-style-type: none"> Check patient condition. Provide alternative ventilation until the issue is resolved. Have the ventilator serviced.
Low frequency	<p><i>Medium priority.</i> Measured fTotal is below the set alarm limit.</p>	<ul style="list-style-type: none"> Check patient condition. Adjust the low fTotal alarm limit.

Alarm	Definition	Action needed
Low minute volume	<i>High priority.</i> Measured ExpMinVol is below the set alarm limit.	<ul style="list-style-type: none"> • Check patient condition. • Check the breathing circuit and artificial airway of the patient for leaks and/or disconnection. • Check and confirm settings, including alarms.
Low oxygen	<p><i>High priority.</i></p> <p>One of the following has occurred:</p> <ul style="list-style-type: none"> • If the oxygen alarm limits are set automatically, the measured oxygen is more than 5% (absolute) below the current Oxygen control setting. • If the Set Oxygen alarm limits manually checkbox is selected in Configuration, the measured oxygen is below the set lower limit. 	<ul style="list-style-type: none"> • Check patient condition. • Check the oxygen supply. Provide an alternative source of oxygen, if necessary. • Calibrate the O2 sensor. • Provide alternative ventilation and install a new O2 sensor. • If using a paramagnetic O2 sensor, calibrate the sensor or have the ventilator serviced.
Low pressure	<i>High priority.</i> The set pressure during inspiration was not reached.	<ul style="list-style-type: none"> • Check patient condition. • Check the breathing circuit for a disconnection between the patient and the flow sensor, or for other large leaks.
Maximum leak compensation	<p><i>Low priority.</i> The set Vt cannot be reached due to a leak.</p> <p>In APVsimv and APVcmv modes only.</p>	<ul style="list-style-type: none"> • Check patient condition. • Inspect the system for leaks. • Suction the patient, if needed. • Ensure the high Pressure limit is appropriate. • Switch to a different ventilation mode.
No ventilation after power fail	<i>High priority.</i> An error has occurred due to a loss of power. Ventilation is not possible	<ul style="list-style-type: none"> • Provide alternative ventilation. • Contact your Hamilton Medical technical representative. • Have the ventilator serviced.

Alarm	Definition	Action needed
O2 sensor calibration needed	<p><i>Low priority.</i> O2 sensor calibration data is not within expected range, or sensor is new and requires calibration.</p> <p>O2 measurement accuracy is reduced.</p>	<ul style="list-style-type: none"> • Calibrate the O2 sensor. • Verify temperature settings are within environmental specifications. • Replace O2 sensor if required. • Have the ventilator serviced. • If using a paramagnetic O2 sensor, calibrate the sensor or have the ventilator serviced.
O2 sensor defective	<p><i>Low priority.</i> The O2 sensor is depleted.</p> <p>O2 measurement accuracy is reduced.</p>	<ul style="list-style-type: none"> • Replace O2 sensor. • To ensure O2 is always monitored, replace O2 sensor ASAP or use external ISO 80601-2-55-compliant O2 monitor. • If using a paramagnetic O2 sensor, calibrate the sensor or have the ventilator serviced.
O2 sensor missing	<p><i>Low priority.</i> There is no signal from the O2 sensor.</p>	<ul style="list-style-type: none"> • To ensure O2 is always monitored, replace O2 sensor ASAP or use external ISO 80601-2-55-compliant O2 monitor. • If using a paramagnetic O2 sensor, calibrate the sensor or have the ventilator serviced.
O2 sensor not system compatible	<p><i>Low priority.</i> The incorrect type of O2 sensor is installed.</p>	<p>Ensure a Hamilton Medical O2 sensor is used and it is properly installed.</p>
Options not found	<p><i>High priority.</i> Options were not found during startup.</p>	<ul style="list-style-type: none"> • Restart device. • If the problem persists, have the ventilator serviced.
Oxygen supply failed	<p><i>High priority.</i> Oxygen source flow is lower than expected.</p>	<ul style="list-style-type: none"> • Check patient condition. • Check the oxygen supply. Provide an alternative source of oxygen, if necessary. • Check the oxygen source/supply for potential leakage. • Provide alternative ventilation until the issue is resolved.

Alarm	Definition	Action needed
Panel connection lost	<i>High priority.</i> A problem has occurred either with the monitor and display or with communication between the monitor and the ventilator unit.	<ul style="list-style-type: none"> • Immediately provide alternative ventilation. • Turn off the ventilator by pressing the Power button on the back of the device for 10 seconds. • Have the ventilator serviced.
Panel settings file error	<i>Low priority.</i> An error has occurred with the monitor.	<ul style="list-style-type: none"> • Check ventilation settings and dismiss the alarm. Ventilation continues normally. • Restart device if possible. • If the problem persists, have the ventilator serviced.
Performance limited by high altitude	<i>Medium priority, Low after silence.</i> The airway pressure cannot be reached at the current altitude. As long as the device remains above the altitude limit, the pressure cannot be reached, and the alarm is active.	<ul style="list-style-type: none"> • Check patient condition. • If at all possible, consider lowering altitude to reach the target performance. • Provide alternative ventilation until the issue is resolved.
PetCO2 high	<i>Medium priority.</i> PetCO2 exceeds the set alarm limit.	<ul style="list-style-type: none"> • Check patient condition. • Check and confirm settings, including alarms.
PetCO2 low	<i>Medium priority.</i> PetCO2 is below the set alarm limit.	<ul style="list-style-type: none"> • Check patient condition. • Check the breathing circuit and flow sensor/artificial airway of the patient for leaks. • Check and confirm settings, including alarms.
Pressure limit has changed	<i>Low priority.</i> The pressure limit setting (P _{limit}) has changed. Either the P _{limit} setting or the high Pressure alarm limit setting has been adjusted by the operator. Changing P _{limit} or the high Pressure alarm limit automatically changes the other: The high Pressure alarm limit is always 10 cmH ₂ O greater than P _{limit} .	<p>Make sure the pressure limit is high enough so that sufficient pressure can be applied for adequate breath delivery.</p> <p>If sufficient pressure cannot be applied, the Pressure limitation alarm is generated.</p>

Alarm	Definition	Action needed
Pressure limitation	<i>Medium priority, Low after silence.</i> Inspiratory pressure, including PEEP/CPAP, is above the pressure limit (P _{limit}). The ventilator limits applied pressure, so the target pressure or volume may not be achieved.	<ul style="list-style-type: none"> • Check the patient for adequate ventilation. • Check and confirm settings, including alarms.
Pressure not released	<i>High priority.</i> Airway pressure has exceeded the Pressure limit, and the pressure was not released over the expiratory valve after 5 seconds. The ventilator enters the Ambient state.	<ul style="list-style-type: none"> • Check expiratory valve and breathing circuit for kinks and occlusions. • Provide alternative ventilation until the issue is resolved. • Have the ventilator serviced.
Real-time clock failure	<i>Medium priority.</i> The date and time are not set.	Set the date and time (System > Settings window).
Release valve defective	<p><i>Low priority.</i> During the routine check of the ambient valve during a Leak test, the valve was found to be defective.</p> <p>The alarm is reset when a Leak test is successfully passed.</p> <p>Ventilation is not necessarily affected.</p>	If the problem still persists, have the ventilator serviced as soon as possible.
Remote communication error	<p><i>Only when connected to an external device using the Hamilton Block (ACK) protocol.</i></p> <p><i>Medium priority.</i> Communication with the external device is not functioning properly.</p> <p>Connection to the external device is lost until the problem is resolved.</p>	<ul style="list-style-type: none"> • Check the cable and connection to the indicated COM port on the ventilator and the connection port on the device. • Consult the external device manufacturer's <i>Instructions for use</i> for additional details about resolving communication errors.

Alarm	Definition	Action needed
Remote communication timeout	<p><i>Only when connected to an external device using the Hamilton Block (ACK) protocol.</i></p> <p><i>Medium priority.</i> The ventilator has lost communication with the external device for at least 2 seconds.</p> <p>Connection to the external device is lost until the problem is resolved.</p>	<ul style="list-style-type: none"> • Check the cable and connection to the indicated COM port on the ventilator and the connection port on the device. • Consult the external device manufacturer's <i>Instructions for use</i> for additional details about resolving communication errors.
Replace HEPA filter	<p><i>Low priority.</i> The air inlet HEPA filter shows increased resistance.</p>	<p>Replace the HEPA filter as soon as possible.</p>
Replace O2 sensor	<p><i>High priority.</i> Communication error, O2 sensor is defective.</p> <p>Ventilation is not necessarily affected. Oxygen concentration should not be affected by this issue. Ventilation can continue.</p>	<ul style="list-style-type: none"> • Replace O2 sensor. • If you cannot replace the O2 sensor, consider disabling it. • If using a paramagnetic O2 sensor, calibrate the sensor or have the ventilator serviced.
Safety mode	<p><i>Technical fault.</i> A hardware or software issue was detected. The ventilator switches to Safety mode.</p>	<ul style="list-style-type: none"> • Provide alternative ventilation until the issue is resolved. • Have the ventilator serviced.
Safety ventilation	<p><i>Technical fault.</i> A hardware or software issue was detected. The ventilator switches to Safety ventilation.</p>	<ul style="list-style-type: none"> • Provide alternative ventilation until the issue is resolved. • Have the ventilator serviced.
Self test failed	<p><i>High priority.</i> The self test failed during startup. The Start ventilation button is unavailable.</p> <p>Note that if this error occurs when the device is restarting from a complete power loss, the device enters the Ambient state.</p>	<ul style="list-style-type: none"> • Restart device. • If the problem persists, have the ventilator serviced. • If the device enters the Ambient state, provide alternative ventilation and have the ventilator serviced.
Settings file error	<p><i>Low priority.</i> The ventilator settings information cannot be loaded.</p>	<ul style="list-style-type: none"> • Check ventilation settings and dismiss the alarm. Ventilation continues normally. • Restart device if possible. • If the problem persists, have the ventilator serviced.

Alarm	Definition	Action needed
Suctioning maneuver	<i>Low priority.</i> Ventilation suppression is active, and ventilator settings are being maintained, although the ventilator is not delivering breaths.	Resume ventilation when desired by first reconnecting the patient.
Technical event: xxxxxx	<i>Low, medium, or high priority.</i> A hardware or software issue was detected. A technical alarm cannot typically be corrected by the operator. Ventilation continues.	Have the ventilator serviced.
Technical fault: xxxxxx	<i>Technical fault.</i> A hardware or software issue was detected. The ventilator switches to the Ambient state or to Safety ventilation.	<ul style="list-style-type: none"> • Provide alternative ventilation until the issue is resolved. • Have the ventilator serviced.
Technical state failed	<i>Technical fault.</i> There is a problem with the hardware configuration. Ventilation is not possible.	Have the ventilator serviced.
Touch not functional	<i>Low priority.</i> The touch screen is defective.	<ul style="list-style-type: none"> • Turn the ventilator off and on again. • If the problem persists, have the ventilator serviced.
Unknown part number	<i>Technical fault.</i> A hardware or software issue was detected. The ventilator switches to the Ambient state.	<ul style="list-style-type: none"> • Provide alternative ventilation until the issue is resolved. • Have the ventilator serviced.
Vent outlet temperature high	<i>High priority.</i> The inspiratory temperature is too high. Ventilation continues, but if temperature stays high, the ventilator may enter the Ambient state.	<ul style="list-style-type: none"> • Check whether the room temperature exceeds the ventilator's operating temperature limit. • Check that the air intake on the device is not obstructed. • Provide alternative ventilation until the issue is resolved. • Have the ventilator serviced if temperature cannot be reduced.
Ventilation canceled	<i>Technical fault.</i> A hardware or software issue was detected. The ventilator switches to the Ambient state.	<ul style="list-style-type: none"> • Provide alternative ventilation until the issue is resolved. • Contact your Hamilton Medical representative. • Have the ventilator serviced.

Alarm	Definition	Action needed
Vt high	<p><i>Medium priority.</i> Measured VTE exceeds the set limit for 2 consecutive breaths.</p> <p>In invasive modes, if the delivered tidal volume exceeds 150% of set high Vt alarm limit ($Vt > 1.5 * \text{high Vt alarm limit}$), the Inspiratory volume limitation alarm is generated.</p>	<ul style="list-style-type: none"> • Check the pressure and volume settings for potential leaks and/or disconnections. • Check and confirm settings, including alarms.
Vt low	<p><i>Medium priority.</i> Measured VTE is below the set limit for 2 consecutive breaths.</p>	<ul style="list-style-type: none"> • Check patient condition. • Check and confirm settings, including alarms. • Check the breathing circuit and artificial airway of the patient for leaks, kinked limbs or tubing, or disconnection.

9.5 Working with a distributed alarm system (DAS)

Before proceeding, review the safety information in Chapter 1.

WARNING

- Any distributed alarm system used with the ventilator *must* comply with IEC 60601-1-8:2006/A1:2012 Section 6.11.2.2.1. Any device that does not comply *cannot* be relied upon for the receipt of ventilator alarms.
- Ensure alarms are audible at your distributed alarm system monitoring device.
- Regularly check the patient and the ventilator when connected to a distributed alarm system (DAS).

NOTICE

The delay between the generation of an alarm and the transmission of that alarm to the connected DAS is less than 2 seconds.

A *distributed alarm system (DAS)* comprises a network of medical devices capable of detecting alarm conditions, sending generated alarms to one or more external monitoring devices, and displaying the alarms on these external devices, for example, at a central station.

The ventilator can be configured as a part of DAS using a COM port on the back of the ventilator.⁶⁴ The COM port must be configured with the Hamilton Block (ACK) protocol.

When configured as part of a DAS, the HAMILTON-C6's audible alarm sound can be paused for an unlimited period of time, referred to as *global AUDIO OFF*.

When Global AUDIO OFF is enabled, ventilator alarms are transmitted to other devices in the DAS, while the visual alarm indicators on the ventilator remain active (Section 9.1).

If you wish to pause the audible alarm on the ventilator, enabling Global AUDIO OFF comprises the following steps:

To ...	See ...
Connect ventilator to a DAS	Section 4.8 and the <i>Communication Interface user guide</i>
Select the communication protocol	Section 14.3.3
Enable Global AUDIO OFF	Section 9.5.1

For details about the other devices in your DAS, see the associated manufacturer's *Instructions for Use*.

9.5.1 Enabling Global AUDIO OFF

To enable Global AUDIO OFF, the ventilator must be connected to a DAS-compatible remote device and the appropriate communication protocol must be selected.

To enable Global AUDIO OFF

1. Touch **System > Settings**.
2. Touch **Loudness**.
3. Select the Global AUDIO OFF state checkbox (Figure 9-6).

The text Ready for Global AUDIO OFF is displayed in the message bar.

4. Press  (Audio pause) to activate Global AUDIO OFF.

The text **Global AUDIO OFF** is displayed in the message bar. Most ventilator alarms are silenced. See Section 9.5.2 for alarms that still generate an audible alarm.

Figure 9-6. Enabling the Global AUDIO OFF state

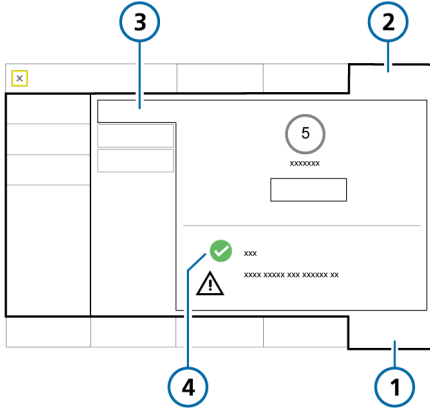

- | | |
|------------|--------------------------|
| 1 System | 3 Loudness |
| 2 Settings | 4 Global AUDIO OFF state |

To stop Global AUDIO OFF and end the Audio pause

- ▶ Press .

The Audio pause on the ventilator is cancelled. All ventilator alarms generate an audible alarm.

9.5.2 About DAS-related alarms

WARNING

When an Audio pause is active, the following critical alarms still generate an audible alarm:

- Apnea
- Check flow sensor for water
- Loss of external power
- No ventilation after power fail
- Oxygen supply failed
- Panel connection lost
- Remote communication error
- Remote communication timeout
- SpO2 low
- Technical events: 231003, 243001, 243002, 283007, 284003, and 285003
- All technical faults

Certain alarms still generate an audible alarm when **Global AUDIO OFF** is enabled. When any of the above-listed alarms is generated, **Global AUDIO OFF** is disabled, and the ventilator alarm sounds.

You must manually re-enable **Global AUDIO OFF** as described next.

To resolve the alarm and re-enable Global AUDIO OFF

1. Resolve the alarm condition (Table 9-2).
2. Press  (Audio pause).

The text Global AUDIO OFF is again displayed in the message bar. Ventilator alarms are silenced as described in Section 9.5.1.

The following ventilator alarms indicate a communication problem between the ventilator and the remote device:

- Remote communication timeout
- Remote communication error

For details about these alarms, see Table 9-2.

10

Ventilation settings and functions

10.1	Overview.....	230
10.2	Accessing settings during ventilation	230
10.3	Entering/exiting Standby	231
10.4	Oxygen enrichment.....	233
10.5	Manual breath	234
10.6	Inspiratory and expiratory hold	235
10.7	Working with a nebulizer	236
10.8	Locking and unlocking the touch screen.....	238
10.9	Capturing a screenshot	239
10.10	Setting display options	239
10.11	About the Event log	241

10.1 Overview

Before proceeding, review the safety information in Chapter 1.

This chapter describes changing ventilation settings during active ventilation, as well as how to perform special functions on the ventilator.

10.2 Accessing settings during ventilation

You can change patient data and ventilation control settings during ventilation, as needed.

10.2.1 Accessing patient data during ventilation

NOTICE

Changing the patient height (Adult/Ped.) or weight (Neonatal) automatically adjusts the following settings based on the recalculated IBW or updated Weight:

- Apnea backup setting (when set to Automatic)
- Safety ventilation startup values

Other settings and alarm limits are not adjusted.

During ventilation, the Controls > Patient window displays the basic patient profile, including sex, height, and ventilation time (Section 5.2).

When the ventilator is in Standby, the patient controls are accessible in the Standby window.

Note that if you are ventilating using the Last patient setup, these controls are greyed out and unavailable.

To change patient data during ventilation

- ▶ Do either of the following:
 - Touch the **Patient** icon at the top left of the display, next to the mode name (Figure 10-1).
 - Touch **Controls**, then touch the **Patient** button, and adjust settings as needed.

Figure 10-1. Controls > Patient window (Adult/Ped shown)

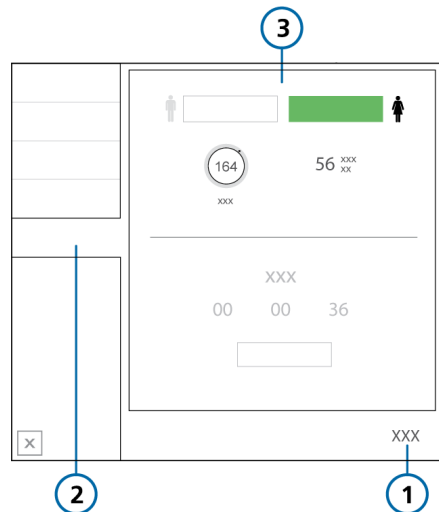

- | | | | |
|---|----------|---|---|
| 1 | Controls | 3 | Adult/Ped: Sex and height, calculated IBW; Neonatal: Weight |
|---|----------|---|---|

- | | |
|---|---------|
| 2 | Patient |
|---|---------|

10.2.2 Accessing settings during ventilation

At any time during ventilation, you can adjust settings, as needed. Changes are applied immediately.

- Touch any MMP, the SpO2 parameter under the MMPs, or the **Alarms** button to access the alarm limit controls.
- Touch **Controls** to access the mode controls. Some controls are also available on the right side of the main display.
- Touch the mode name at the top left of the display (Figure 5-1) or the **Modes** button to change the selected ventilation mode.

The mode changes at the end of the current breath cycle.

Note that you can only select the HiFlowO2 and nCPAP-PS modes when in Standby.

- Touch the **Patient** icon or touch **Controls** > **Patient** to access patient settings.
- Touch the **Home** icon to reset the display to the default configuration set for the selected Quick Setup.
- Touch the **IntelliCuff** or **Humidifier** icons to access the respective settings windows.

The ventilator monitor also provides access to key functions.

Keys on the front of the ventilator provide access to important functions, including entering Standby mode and pausing the audible alarm.

Figure 10-2. Function keys

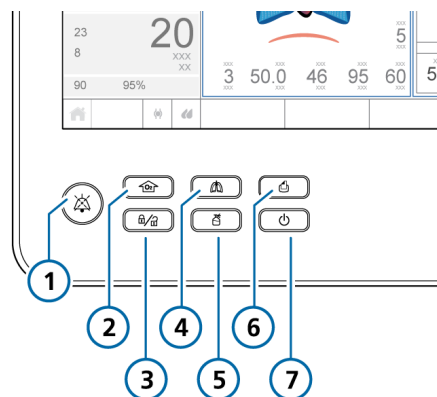

- | | |
|--------------------------------|---------------------------|
| 1 Audio pause | 5 Nebulizer on/off |
| 2 O2 enrichment/
suctioning | 6 Print screen |
| 3 Screen lock/
unlock | 7 Power/Standby
unlock |
| 4 Manual breath | |

10.3 Entering/exiting Standby

WARNING

When in Standby, the ventilator does *not* automatically resume ventilation when the patient is reconnected. You must manually restart ventilation.

NOTICE

- Patient alarms are suppressed in Standby.
- Acoustic patient alarms are suppressed for 1 minute after starting ventilation from Standby.

Standby is a waiting mode that lets you maintain ventilator settings while the ventilator is not performing any ventilatory functions.

To put the ventilator into Standby

1. Press and quickly release  (Power/Standby) while the ventilator is turned on (Figure 10-2).

The Activate Standby window opens (Figure 10-3).

2. Touch **Activate standby**.

The Standby window opens (Figure 10-4).

In Standby, the Power/Standby key backlight is green.

While in Standby, the window shows the elapsed time the ventilator has been in Standby.

Note that, if another window is open on the display, the elapsed time appears in a small yellow box on the left side of the Standby window.

Figure 10-3. Activate Standby window

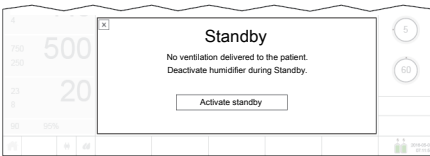
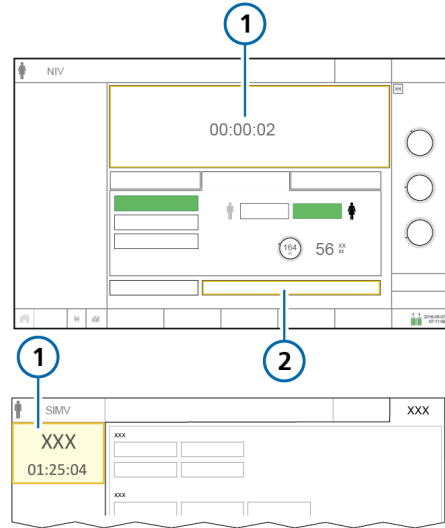



Figure 10-4. Standby window



- | | |
|---|--|
| <ol style="list-style-type: none"> 1 Elapsed time in Standby | <ol style="list-style-type: none"> 2 Start ventilation (when HiFlowO2 is selected: Start therapy) |
|---|--|

To end Standby and start ventilation

- ▶ Do either of the following:
 - Touch **Start ventilation**. If HiFlowO2 is selected, the button is labeled **Start therapy**.
 - Press and quickly release .

Ventilation resumes with the previous settings. During active ventilation, the Power/Standby key backlight is white.

10.4 Oxygen enrichment

NOTICE

- Oxygen alarms are suppressed while O2 enrichment is active.
- The **Disconnection on patient side** alarm is suppressed while O2 enrichment is active.

Oxygen enrichment is useful before or after tracheal/endotracheal suctioning and for other clinical applications.

The device delivers the following oxygen concentration for 2 minutes depending on the selected patient group:

- **Adult/Ped.** 100% oxygen
- **Neonatal.** 125% of the current Oxygen setting

To start oxygen enrichment

- ▶ Press  (O2 enrichment) (Figure 10-2).
After a short time, the ventilator starts delivering increased oxygen (see above).

When active, the key backlight is green. The **Oxygen** control turns green and displays the currently applied concentration, with a countdown timer.



When finished, the ventilator resets the concentration to the previous operator-set value.

To stop O2 enrichment manually

- ▶ Do either of the following:
 - Press .

Ventilation resumes at the previous operator-set oxygen concentration.

- Change the O2 concentration using the **Oxygen** control.

Ventilation resumes at the set oxygen concentration.

10.4.1 Performing an open-suctioning maneuver

CAUTION

Air leaks may compromise the ventilator's ability to detect a reconnection of the patient after the open-suctioning maneuver, resulting in no ventilation being delivered for the remaining suctioning period (up to 60 seconds). In such cases, stop the maneuver manually, as described in the following procedure.

NOTICE

Note that the Suctioning tool is *only* available if the option is enabled on your device.

The Suctioning tool is intended to protect the operator from possible contamination, as well as ensure the patient's safety during an open-suctioning maneuver. Note that the Suctioning tool stops ventilation when a patient disconnection is detected by the ventilator.

Suctioning may affect measured values.

Suctioning is disabled when using:

- HiFlowO2
- NIV or NIV-ST modes

To perform an open suctioning maneuver

1. Press  (O2 enrichment) for pre-oxygenation.
2. Disconnect the patient.
The text **Suctioning maneuver** is displayed in the message bar.
Disconnecting the patient stops ventilation so that no gases are blown through the breathing circuit. All alarms are suppressed for one minute.
3. Use a suctioning catheter (not included) to suction all secretions out of the patient's airway.
4. Reconnect the patient to the ventilator.

Ventilation resumes, post-oxygenation starts, and all acoustic alarms are again suppressed for one minute. Alarm messages and the alarm lamp are still active.

To stop the maneuver manually

- ▶ Press  again.

10.4.2 About closed-suctioning maneuvers

NOTICE

When performing a closed-suctioning maneuver, follow your institution's protocols.

Verify alarm limit settings and consider whether O2 enrichment should be used prior to performing a closed-suctioning maneuver.

If the Suctioning tool is enabled on your device, ensure O2 enrichment is *not* active when performing the closed-suctioning maneuver.

When performing a closed-suctioning maneuver, ventilation continues and the current settings do *not* need to be adjusted.

You can perform a closed-suctioning maneuver with the following pressure-controlled ventilation modes: APVcmv, APVsimv, PCV+, PSIMV+, DuoPAP, APRV, SPONT, ASV, or INTELLIVENT-ASV.

10.5 Manual breath

You can prolong inspiration as well as deliver a manually triggered breath.

When active, the **Manual breath** key backlight is green.

Note that manual breath is disabled during HiFlowO2.

To deliver a manual breath

- ▶ Press and release  (Manual breath) during exhalation (Figure 10-2).

The manual breath uses the mandatory breath settings (standard or operator set).

If you try to initiate a manual breath during the early stage of inspiration or the early stage of exhalation, the breath will not be delivered.

To deliver a prolonged inspiration

- ▶ Press and hold  (Manual breath) during any breath phase.

If the ventilator is in exhalation, the device applies a minimum exhalation phase and then switches to inspiration. The device maintains the inspiration pressure until you release the key, or for a maximum of 15 seconds.

10.6 Inspiratory and expiratory hold

The ventilator supports both inspiratory and expiratory holds.

Note that holds are disabled in HiFlowO2.

10.6.1 Inspiratory hold

An inspiratory hold closes the inspiratory and expiratory valves for a short time. Perform this maneuver to calculate true plateau airway pressure.

Figure 10-5. Hold window

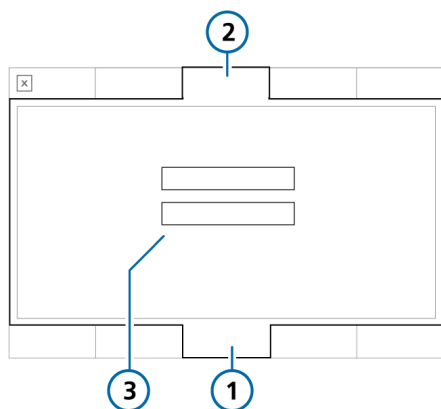

- | | |
|---------|--|
| 1 Tools | 3 Inspiration hold and Expiration hold |
| 2 Hold | |

To perform an inspiratory hold

1. Touch **Tools** > **Hold**.
2. Touch **Inspiration hold**.
The ventilator performs an inspiratory hold as follows:
 - **Adult/Ped.** 10-second hold
 - **Neonatal.** 3-second hold

To stop the inspiratory hold early, touch **Inspiration hold** again.

A progress bar appears for the length of the hold.

At the end of the hold, the window closes. The waveforms are frozen on the display.

3. Review the waveforms as appropriate.
4. Touch  (**Freeze**) or press the P&T knob to unfreeze the display.

10.6.2 Expiratory hold

Perform this maneuver to measure the pressure within the patient airways and the patient's effort and strength for inspiration. It is used to calculate intrinsic PEEP.

The ventilator ambient valve opens at 3 cmH2O below ambient pressure. Note that pressure values below -3 cmH2O are not displayed.

To perform an expiratory hold

1. Touch **Tools** > **Hold**.
2. Touch **Expiration hold**.
The ventilator performs an expiratory hold as follows:
 - **Adult/Ped.** 10-second hold
 - **Neonatal.** 3-second hold

To stop the expiratory hold early, touch **Expiration hold** again.

A progress bar appears for the length of the hold.

At the end of the hold, the window closes. The waveforms are frozen on the display.

3. Review the waveforms as appropriate.
4. Touch  (**Freeze**) or press the P&T knob to unfreeze the display.

10.7 Working with a nebulizer

The ventilator supports the use of both pneumatic and Aerogen nebulizers.

This section provides details about working with the nebulizer.

Table 10-1. Nebulization overview

For ...	See ...
Setting nebulization duration and breath cycle synchronization	Section 10.7.1
Pneumatic nebulization	Section 10.7.2
Aerogen nebulization	Section 10.7.3

10.7.1 Specifying duration and synchronization settings

You can specify the following settings for nebulization:

Table 10-2. Nebulizer setting options

Setting	Description
Duration	The length of time nebulization will be delivered
Continuous	Nebulization is delivered for an unlimited duration
Synchronization	When nebulization will be delivered during the breath cycle

In Configuration, these settings can be stored as defaults for the selected Quick Setup (Section 14.6).

The timer in the System > Nebulizer window shows how long nebulization has been active. The window also shows the set Duration. If you change any of the nebulization settings while nebulization is active, the timer resets to 0.

To select the nebulization duration

1. Touch **System > Nebulizer** (Figure 10-6).
2. Touch the **Duration** control and select a value between 5 and 40 minutes. By default, duration is set to 30 minutes. For an unlimited duration, that is, nebulization is active until you press the **Nebulizer** key again to stop it, select the **Continuous** check box.

To specify synchronization options

You can change these settings at any time regardless of whether nebulization is active.

- ▶ In the System > Nebulizer window (Figure 10-6), touch the desired **Synchronization** setting. The options are described in Table 10-3.

Figure 10-6. System > Nebulizer window

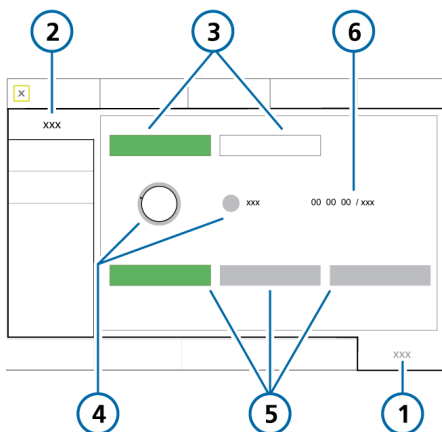

- | | |
|----------------------|---|
| 1 System | 4 Duration control and Continuous checkbox |
| 2 Nebulizer | 5 Inspiration, Expiration, Insp. & Exh. |
| 3 Pneumatic, Aerogen | 6 Nebulization timer (hours, minutes, seconds) and current set Duration |

Table 10-3. Nebulizer synchronization options

Breath phase	The nebulizer medication is delivered ...
Inspiration	During patient inspiration
Exhalation	During patient exhalation
Insp. & Exh.	Continuously, during both inspiration and exhalation

10.7.2 Working with a pneumatic nebulizer

Before proceeding, review the safety information in Chapter 1.

Nebulization with a pneumatic nebulizer is available in most ventilation modes (not available in SIMV/(S)CMV) *except* during neonatal ventilation or when using HiFlowO2.



For delivery of prescribed medications in the ventilator circuit, the ventilator provides a stable pressure source to power a standard inline pneumatic nebulizer connected to the **Nebulizer** port. The pressure delivered allows for an optimum flow of approximately 8 l/min.

The ventilator automatically compensates for the additional volume provided by the pneumatic nebulizer to deliver the set tidal volume.

For effective nebulization, use a pneumatic nebulizer jar.

For additional information about nebulizer use, including adding medication, refer to the manufacturer's *Instructions for use*. For connection and setup details, see Section 4.7.

To start and stop nebulization

1. Press  (Nebulizer) (Figure 10-2).
When active, the key backlight is green.
The nebulizer flow, using 100% oxygen, is synchronized with the breathing phase specified in the **System > Nebulizer** window, for the specified duration (Section 10.7.1).
2. To stop nebulization at any time, press  again.

The key backlight turns white and nebulization stops.

10.7.3 Working with an Aerogen nebulizer



Before proceeding, review the safety information in Chapter 1 and the Aerogen Solo/Aerogen Pro Instructions for Use.

The Aerogen nebulizer system is available as an option. Nebulization with Aerogen is available for all ventilation modes.⁶⁵

You can use an Aerogen nebulizer for delivery of prescribed medications in the ventilator circuit. The nebulizer operates in-line with standard ventilator breathing circuits to aerosolize prescribed medications for inhalation without changing patient ventilator settings. It can be refilled without interrupting ventilation.

For activation and setup details, see Section 4.7 and the *Aerogen Solo/Aerogen Pro Instructions for Use*.

To start and stop nebulization

1. Press  (Nebulizer) (Figure 10-2).
The key backlight turns green when nebulization is active.
Nebulization is synchronized with the breathing phase specified in the **System > Nebulizer** window, for the specified duration (Section 10.7.1).
2. To stop nebulization at any time, press  again.
The key backlight turns white and nebulization stops.

During ventilation, the ventilator may generate the **Aerogen nebulizer disconnected** alarm. For details, see Section 9.4.

10.8 Locking and unlocking the touch screen

You can lock the touch screen to prevent inadvertent entries.

When screen lock is active:

- The key backlight is green.
- Touching the screen generates an audible beep and the message, **Screen is locked!**, is displayed.
- Some device controls remain available, while others are disabled, as follows:
 - **Active controls.** Audio pause, Manual breath, O2 enrichment, Nebulizer
 - **Inactive controls.** Touch screen, Power/Standby, Print screen, P&T knob

To lock or unlock the screen

- ▶ Press  (Screen lock/unlock) (Figure 10-2).

⁶⁵ Not available in all markets.

10.9 Capturing a screenshot

Before using a USB drive with the ventilator, review the safety information in Section 1.4.4.

The  (Print screen) key saves a PNG file of the current ventilator display to a USB memory drive.

To capture a screenshot of the display

1. Insert a USB memory drive into the USB port (Figure 2-5).
2. Press  (Figure 10-2) when the desired display is shown.

The device saves the image to the screenshots folder on the memory drive. The key backlight is green while the device saves the image.

The filename uses the following format:

screenshot_C6-sn-yyyy-mm-dd_hh-mm-ss.png

where:

- C6 is the device name
- sn is the device serial number
- yyyy is the year
- mm is the month
- dd is the date
- hh is the hour (in 24-hour format)
- mm is the minute
- ss is the second

10.10 Setting display options

You can set the day and night display brightness, as well as the device date and time.

10.10.1 Setting date and time

You set the date and time for the ventilator in the **System > Settings** window. Ensure the date and time are set correctly so that event log entries have accurate time and date stamps.

To set the date and time

1. Do either of the following:
 - Touch the **Date/Time** indicator at the bottom right of the display (Table 2-4).
 - Touch **System > Settings > Date & Time** (Figure 10-7).
2. Adjust the date and time, then touch **Apply** to save the changes.

Figure 10-7. Date & Time settings

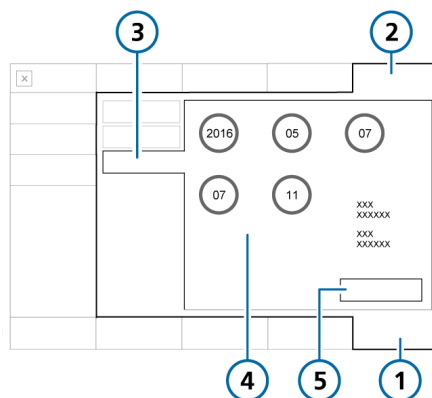

- | | |
|---------------|--------------------------|
| 1 System | 4 Date and time settings |
| 2 Settings | 5 Apply |
| 3 Date & Time | |

10.10.2 Day and night display brightness

Use these settings to set the brightness of the display for use during the day and night.

To set the display brightness

1. Touch **System** > **Settings** (Figure 10-8).
2. Touch **Day & Night**.
3. To select **Day** mode with a bright display, touch the **Day** button.
To select **Night** mode with a dimmer display, touch the **Night** button.
4. Adjust the brightness of the display in each mode using the **Brightness** control. The setting you choose becomes the new default for that mode.
5. To have the device control the brightness based on ambient light, touch the **Automatic** button.

The device continuously senses the available light and dynamically adjusts the display brightness settings.

Figure 10-8. Day & Night window

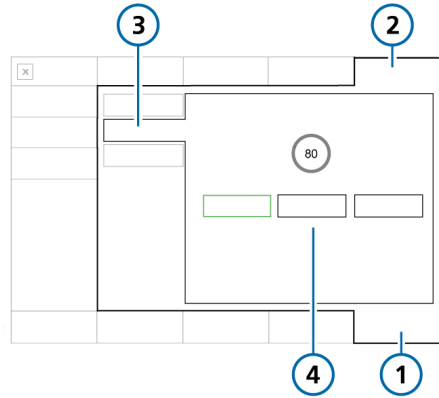

- | | |
|------------|--|
| 1 System | 3 Day & Night |
| 2 Settings | 4 Day, Night, Automatic, Brightness settings |

Table 10-4. Day and Night settings

Setting	Brightness range	Default
Day	10% to 100%	80%
Night	10% to 100%	40%

10.11 About the Event log

Once the ventilator is turned on, event logs collect data about clinically relevant ventilator activities, including alarms, technical notes, setting changes, calibrations, maneuvers, and special functions.

The date, time, and a unique identification reference (ID) for event classification is included.

Alarms are shown in color, depending on priority level (yellow for low or medium, red for high).

A more extensive log including technical and configuration details is available to service engineers.

When setting up a new patient:

- Data is appended to the existing event log when you select the **Last patient** tab.
- The event log is cleared and starts again when you select a different patient group tab (**Adult/Ped** or **Neonatal**).

Event log data persists after shutting off the ventilator or in the event of a power loss. A maximum of 10,000 events is stored. When a log buffer is full, new events overwrite the oldest log entries.

You can copy event log data. See Section 10.11.1.

To display the Event log

- ▶ Touch **Events**.

Figure 10-9. Events window

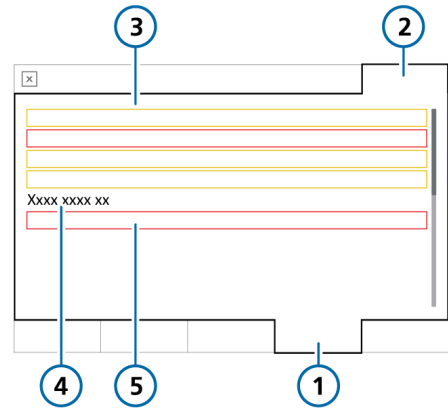

- | | |
|---------------------------------------|-----------------------------|
| 1 Events | 4 Informational message |
| 2 All | 5 High-priority alarm (red) |
| 3 Low-/medium-priority alarm (yellow) | |

10.11.1 Copying event log data

Before using a USB drive with the ventilator, review the safety information in Section 1.4.4.

You can save the event and service logs to a USB drive. The drive must have a FAT or FAT32 format and it must *not* have an operating system or a security system installed.

To copy the log

1. Place the ventilator into **Standby** and insert a USB drive into the USB port (Figure 2-5).
2. Touch **Tools > Utilities** (Figure 10-10).
3. Touch **Export Logs**.
4. Remove the USB drive when the text **Export successful** is displayed.

The log files are saved to the folder named C6-sn<serial number> on the USB drive.

Figure 10-10. Data transfer window

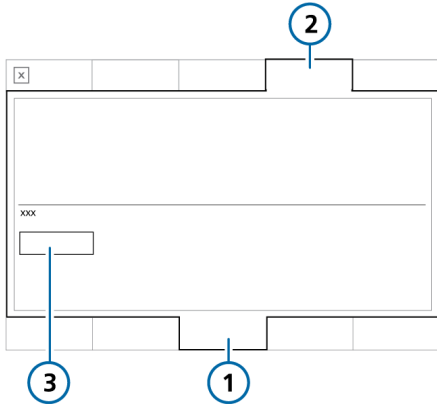

- 1 Tools
- 2 Utilities
- 3 Export Logs

11

Working with P/V Tool

11.1	Overview.....	244
11.2	Using the P/V Tool.....	245
11.3	Opening the P/V Tool.....	246
11.4	Adjusting the control settings.....	247
11.5	Performing a P/V Tool maneuver	248
11.6	Analyzing the data	251
11.7	Using reference curves	251
11.8	Performing a recruitment maneuver	252

11.1 Overview

Before proceeding, review the safety information in Chapter 1.

P/V Tool Pro (referred to as *P/V Tool*) is a diagnostic and recruitment tool. It allows you to perform a maneuver to assess the total compliance for the entire respiratory system, including the lungs and the chest wall. Lung compliance is recorded in a quasi-static pressure volume curve.

P/V Tool helps the clinician:

- Determine the patient's lung characteristics and lung compliance.
- Define the maximum plateau pressure for ventilation.
- Determine the positive end-expiratory pressure (PEEP) that will improve oxygenation, reduce end tidal CO₂, avoid alveoli collapse after a recruitment maneuver, and improve lung compliance.
- Perform a P/V Tool maneuver to assess the total compliance for the entire respiratory system, including the lungs and the chest wall. Lung compliance is recorded in a quasi-static pressure volume curve.
- Perform a recruitment maneuver to open or reinflate collapsed alveoli in the lungs.
- Define recruited volume and calculate when there is no longer extra lung to recruit.

11.1.1 Conditions for use

The following conditions must be met before performing a P/V Tool maneuver:

- The patient is intubated and passive, that is, *not* breathing spontaneously.
- The breathing circuit is gas tight.
There must be no gas leak throughout the entire system of the ventilator, the breathing circuit, or at the ventilated patient.
- Nebulization is deactivated.

P/V Tool is disabled during nebulization and for five breaths following nebulization.

- The flow sensor must perform optimally.

The accuracy of the information provided depends on the quality of the flow sensor connection. P/V Tool is disabled when the **Flow sensor calibration needed** alarm is active.

- P/V Tool is *enabled* in the following modes: (S)CMV, SIMV, APVcmv, APVsimv, PCV+, PSIMV+, DuoPAP, APRV, ASV, and INTELLiVENT-ASV.
- P/V Tool is *disabled* when using the following modes/features: SPONT, NIV, NIV-ST, nCPAP-PS, Apnea backup modes, and HiFlowO₂.
- The patient has received at least five breaths between P/V Tool maneuvers.
- The P/V Tool option is activated on the ventilator.

11.1.2 Indications for use

Use of the P/V Tool is indicated for adult, pediatric, and neonatal patients provided that the required conditions are met as described in Section 11.1.1.

11.1.3 Contraindications for use

Use of the P/V Tool is contraindicated if *any* of the following conditions apply:

- Air leaks
- Pregnancy
- Lung emphysema
- Hemodynamic instability
- Confirmed or suspected intracranial hypertension
- Patients who cannot tolerate high intrapulmonary pressure (e.g., right heart failure)

11.2 Using the P/V Tool

Before proceeding, review the information in Sections 11.1.1 through 11.1.3.

Using the P/V Tool involves the following steps:

To ...	See ...
Open the P/V Tool	Section 11.3
Adjust control settings	Section 11.4
Perform a P/V Tool maneuver	Section 11.5
View the data	Section 11.5.1
Use reference curves	Section 11.7
Perform a recruitment maneuver	Section 11.8

Using the P/V Tool does not require any disconnection of the breathing circuit or changes to ventilation settings.

You can use the P/V Tool during active ventilation.

11.3 Opening the P/V Tool

To open the P/V Tool

1. Touch **Tools** > **P/V Tool**.
 2. Review the safety information, then touch **Confirm** to continue.
- The P/V Tool window opens (Figure 11-1).

Figure 11-1. P/V Tool window

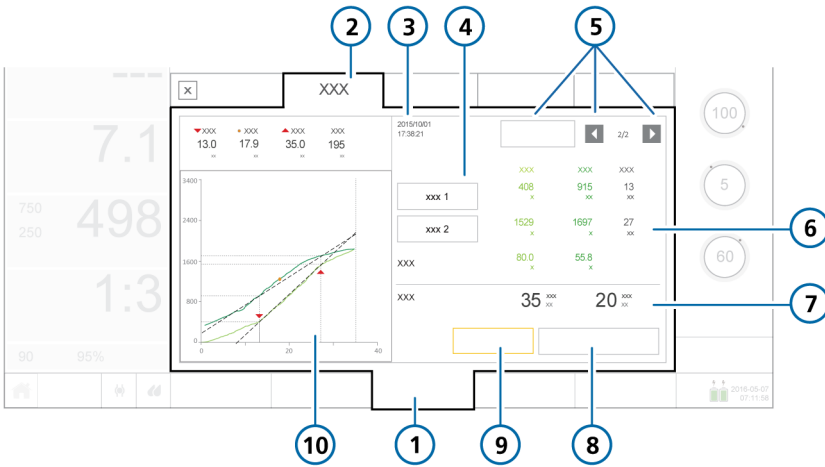

- | | | | |
|---|--|----|---------------------------------|
| 1 | Tools | 6 | Numerical data related to graph |
| 2 | P/V Tool | 7 | Current settings |
| 3 | Date and time of maneuver | 8 | Start/Stop maneuver |
| 4 | Cursors 1 and 2 | 9 | Settings |
| 5 | Reference button and history navigation arrows | 10 | P/V Tool Graphics panel |

The next step is to adjust the control settings.

11.4 Adjusting the control settings

NOTICE

- Set **Ptop** to a low value to prevent generation of excessive volumes when performing a maneuver on patients with obstructive “soft lung” diseases, such as COPD.
- Set a low ramp speed to ensure accurate data when performing a P/V Tool maneuver. The ramp speed also dictates the length of the maneuver.

You can configure the control parameters listed in Table 11-1 for a P/V Tool maneuver.

To adjust control settings

1. In the P/V Tool window, touch **Settings**.
The Settings window opens (Figure 11-2).
2. Review and, if needed, adjust the settings.
The controls **Ptop**, **Tpause**, and **End PEEP** may require extra steps when adjusting them, as described in the following sections.

Table 11-1. P/V Tool control settings

Control	Description
Pstart (cmH2O)	Starting pressure. Default value: Current PEEP
Ptop (cmH2O)	Target high pressure during the maneuver. Default value: 35
End PEEP (cmH2O)	End pressure and PEEP to be applied after the maneuver. Default value: Current PEEP

Control	Description
Ramp speed (cmH2O/s)	Rate of pressure change; the time taken to reach the target pressure. Default value: 3
Tpause (s)	Length of the pause during the P/V Tool maneuver; time during which the target pressure will be applied. Default value: 0
Tmaneuver (s)	The length of the maneuver. This is a calculated value based on the settings of the above-listed controls. Default value: --

Figure 11-2. P/V Tool control settings

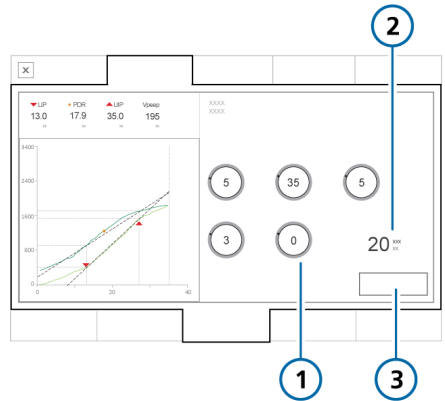

- 1 Control settings (Table 11-1)
- 2 Calculated Tmaneuver value
- 3 Close

To set Ptop > 40 cmH2O or Tpause > 5 seconds

1. Touch the appropriate control to activate it and set it to the maximum allowed value (40 for Ptop, 5 for Tpause).
2. Press the P&T knob to accept the setting.
3. To set either parameter beyond this limit, touch the control again and turn the P&T knob to set the value as desired.
4. Press the P&T knob to accept the changed value.

To set End PEEP or Pstart to a different setting than PEEP/CPAP

1. If setting End PEEP or Pstart to a different value than PEEP/CPAP, the device prompts you to confirm the new setting.
2. Touch **Yes** or **No** to confirm the setting.

The next step is to perform a P/V Tool maneuver. See Section 11.5.

11.5 Performing a P/V Tool maneuver

NOTICE

To avoid the risk of infection, if Intelli-Cuff is connected and being used, prior to performing a recruitment maneuver, inflate the cuff pressure controller to keep the airway tight.

To perform a P/V Tool maneuver

1. Touch **Start/Stop maneuver**.
The device performs a recruitment maneuver for the length of time defined by the settings.
2. To stop the P/V Tool maneuver early, touch **Start/Stop maneuver** again.
At the end of the P/V Tool maneuver, ventilation continues and the results of the maneuver are displayed. See Figure 11-1.

The next step is to review the resulting data.

11.5.1 Viewing data

Data gathered during the P/V Tool maneuver is displayed both graphically and numerically.

To ...	See ...
Choose the data to display	Section 11.5.2
Display numerical data	Section 11.5.2.1
Analyze the curves	Section 11.6
Use a previous curve as reference for comparison	Section 11.7

11.5.2 Choosing the data to display

In the P/V Tool window, you can select from the following graph types:

Table 11-2. P/V Tool graph types

Graph type	Description
Paw/V	Airway pressure to airway volume. The airway pressure in relation to the lung volume. It shows how much pressure is required to inflate the lung at each volume step. See Figure 11-3.
Paw/V + Paw/dV	Airway pressure to airway volume and the difference in airway volume between the inspiratory limb and the expiratory limb. When this view is selected, the difference in airway volume values are displayed in orange on the right side of the P/V Tool window. See Figure 11-4.
Paw/Flow	Airway pressure to airway flow. See Figure 11-5.
Pes/Volume	Pressure measured through the Pes port to airway volume. See Figure 11-6.
Ptranspulm/Volume	Transpulmonary pressure (Paw – Pes) to airway volume. See Figure 11-7.

To select a graph

1. Touch the P/V Tool Graphics panel.
The graph selection window opens, displaying buttons for each of the available options (Table 11-2).
2. Touch the desired button.

The window closes and the selected graph is displayed.

Figure 11-3. Paw/V graph



- 1 Deflation limb (dark green)
- 2 Inflation limb (light green)
- 3 ▼ Lower inflection point (LIP)
- 4 ● Point of de-recruitment (PDR)
- 5 ▲ Upper inflection point (UIP)
- 6 Guidelines between points
- 7 Vpeep (inflated lung volume when the set PEEP is reached)

Figure 11-4. Paw/V + Paw/dV (1) graph

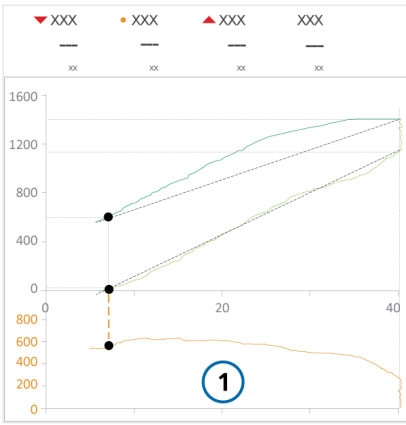
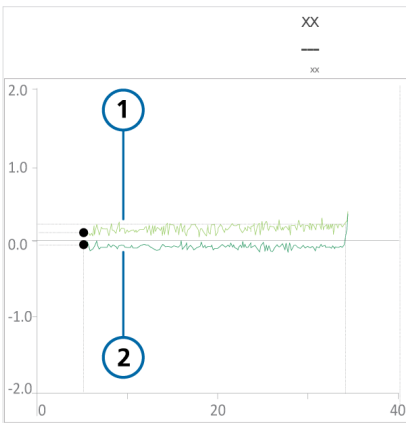

Figure 11-5. Paw/Flow graph



- 1 Inflation limb (light green)
- 2 Deflation limb (dark green)

Figure 11-6. Pes/Volume graph

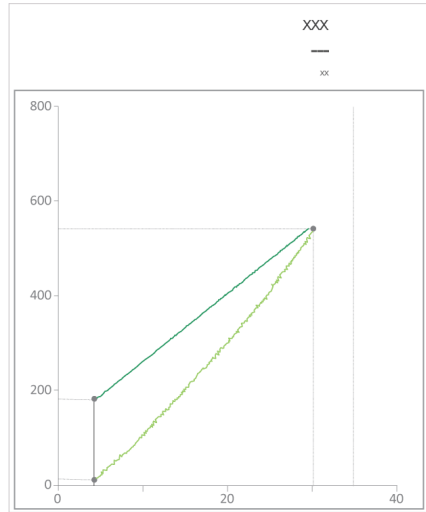
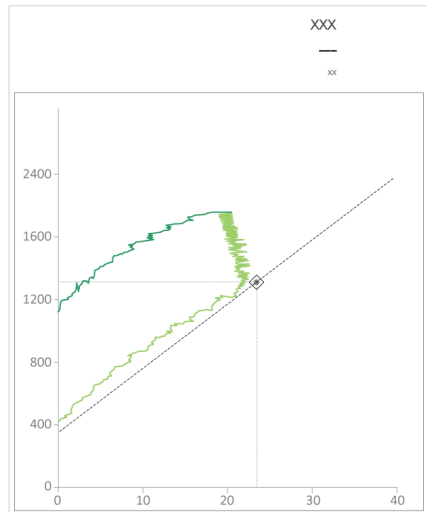

Figure 11-7. Ptranspulm/Volume graph



11.5.2.1 Numerical data

Data is also displayed numerically (Figure 11-8).

The data is dynamic. Depending on what you select in the P/V Tool window, values will change, allowing you to analyze data based on precise values.

For parameter specifications, including ranges and accuracy, see Table 16-6.

Figure 11-8. Reviewing the data

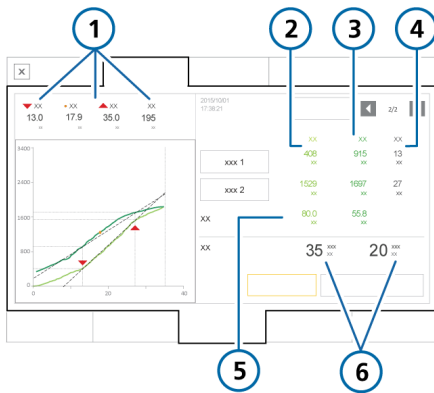

- | | |
|--|------------------------|
| 1 LIP, UIP, PDR, Vpeep values
<i>Includes dV when an appropriate graph is selected.</i> | 4 Airway pressure data |
| 2 Inflation limb data (light green) | 5 Compliance |
| 3 Deflation limb data (dark green) | 6 Current settings |

11.6 Analyzing the data

Once the P/V Tool maneuver is complete, the inflation and deflation limbs of the maneuver are displayed in the P/V Tool Graphics panel.

Use the cursors to move up and down the recorded curves to analyze in precise detail the recorded values on the inflation and deflation limbs.

To move the cursors

1. Touch the **Cursor 1** or **Cursor 2** button (Figure 11-1).
2. Move the cursor using the P&T knob. The displayed data is automatically updated as you move the cursor.
3. Touch the button again to deselect the cursor.

11.7 Using reference curves

The reference curve is used to compare a patient's progress over time or before and after a recruitment maneuver.

Between 3 and 20 curves can be stored depending on the length of the stored maneuvers. The oldest curves are deleted as new recruitment maneuvers are performed.

You can select one inflation/deflation curve as the reference curve, which you can change at any time. This curve is overlaid in the P/V Tool Graphics panel.

Stored settings, reference curves, and data are deleted when the device is restarted or when you start ventilation with a new patient.

Figure 11-9. Displaying a reference curve

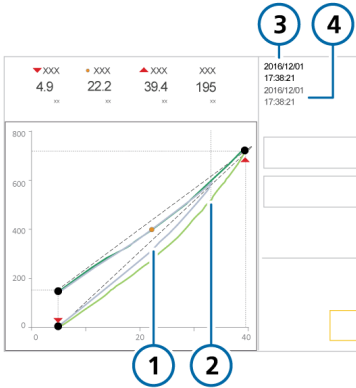

- | | |
|--------------------------|--|
| 1 Reference curve (gray) | 3 Time and date associated with the current (green) curve |
| 2 Current curve (green) | 4 Time and date associated with the reference (gray) curve |

11.8 Performing a recruitment maneuver

The P/V Tool can also be used to perform a recruitment maneuver. For details, see Section 11.5.

Set **P_{top}** to the desired pressure to perform a recruitment maneuver. The duration for the maneuver is determined by the P/V Tool control settings (Table 11-1).

Upon completion of the recruitment maneuver, the resulting graph shows the volume of the lung that has been recruited.

To display a reference curve

1. Touch the left or right navigation arrow keys (Figure 11-1) to scroll through the stored curves.

As you scroll through the stored curves, each curve is displayed in gray in the P/V Tool Graphics panel (Figure 11-9).

2. Touch the **Reference** button to set the displayed curve as the reference.

The reference curve is displayed in gray. The current inflation limb, deflation limb, and associated values are displayed in green.

To deselect a reference curve

- ▶ Touch the **Reference** button again to deselect a reference curve.

12

Working with external devices

12.1	Working with the HAMILTON-H900 humidifier	254
12.2	Working with IntelliCuff.....	264

12.1 Working with the HAMILTON-H900 humidifier

Before proceeding, review the safety information in Chapter 1.

Using the HAMILTON-H900 humidifier with the ventilator offers remote access to humidifier controls and status directly from the ventilator display. In addition, functions between the devices are synchronized.⁶⁶

You can control some humidifier functions from the ventilator or on the humidifier itself.

This section describes using the ventilator to manage and monitor humidifier settings.

For detailed information about the settings, specifications, patient set up, humidifier operation, humidifier configuration, and important safety information, see the *HAMILTON-H900 Instructions for use*.

Table 12-1. Operation overview

For details about ...	See ...
Accessing humidifier controls on the ventilator	Section 12.1.1
Humidification modes	Section 12.1.2
Changing humidity using temperature controls	Section 12.1.3
Entering Standby	Section 12.1.4
Turning the humidifier on/off	Section 12.1.5
Humidifier-related alarms	Section 12.1.6
Humidifier-related parameters	Section 12.1.7

⁶⁶ Not available in all markets.

12.1.1 Accessing humidifier controls on the ventilator

The **Humidifier** window shows the water chamber exit temperature (T humidifier) and the humidifier Y-piece temperature (T Y-piece). It also provides access to the operations listed in Table 12-1.

To open the Humidifier window

- ▶ Do either of the following (Figure 12-1):
 - Touch  (Humidifier).
 - Touch **System > Humidifier**.

If communication between the humidifier and the ventilator is lost, the window is disabled.

Figure 12-1. System > Humidifier window

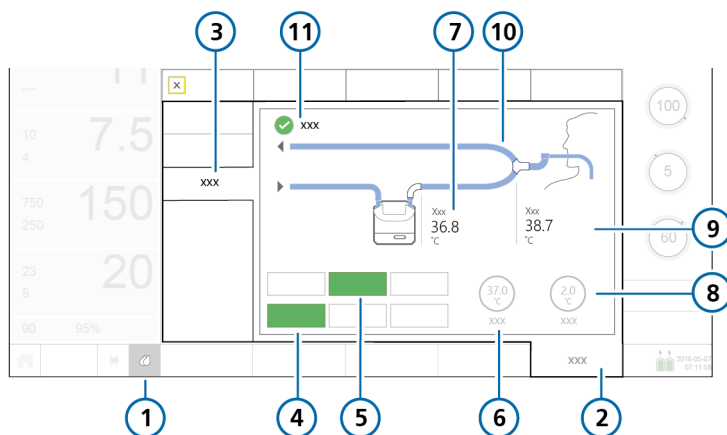

1	Humidifier icon	7	T humidifier
2	System	8	T gradient control
3	Humidifier	9	T Y-piece
4	Active humidification mode (Invasive, NIV, HiFlowO2)	10	Breathing circuit
5	Off, Auto, Manual	11	Exp. temperature increase checkbox
6	Set temp control		

12.1.1.1 About the Humidifier button







The **Humidifier** button () at the bottom left of the display provides quick access to the **Humidifier** window and indicates the state of the humidifier, including whether any alarms are active.

Table 12-2. Humidifier button icon states

Icon state	Description
	<i>Grayed out.</i> Humidifier is not connected. If no icon is displayed, this option is not available in your country.
	<i>Outline only.</i> Humidifier is connected but turned off.
	<i>Full, white.</i> Humidifier is connected and turned on.
	<i>Yellow.</i> Humidifier is connected and a low- or medium-priority humidifier alarm is active.
	<i>Red.</i> Humidifier is connected and a high-priority humidifier alarm is active.

12.1.1.2 Verifying connection status

When communication is established between the humidifier and the ventilator, the active connection status is displayed on both devices: the **Humidifier** icon on the ventilator display (Table 12-2), and the  (**Connection to ventilator**) symbol on the humidifier become active.

Note that the connection status icon on the humidifier is not displayed when in **Standby**.

12.1.2 About the humidification modes

The HAMILTON-H900 offers humidification modes for both invasive (INV) and noninvasive (NIV) ventilation, as well as high flow oxygen therapy (HiFlowO2⁶⁷).

The set mode determines the initial temperature settings at the water chamber exit and at the Y-piece, as well as the allowed temperature ranges for these settings. The control settings are described in Table 12-3.

The **Invasive** mode allows for a higher temperature range than the **NIV** mode. For details about the humidifier settings and ranges, see the *HAMILTON-H900 Instructions for use*.

The **System > Humidifier** window displays a breathing circuit diagram that reflects the selected humidifier mode and displays the selected mode button in green.

The currently set humidification mode is shown in the **System > Humidifier** window. You can change the humidifier mode at any time.

Figures 12-2 through 12-4 show examples of the **Humidifier** window for each mode.

When connected to the ventilator, the humidifier *automatically* matches the humidification mode to the type of ventilation mode selected on the ventilator. For example, when the mode on the ventilator is invasive, such as **ASV**, the humidifier is automatically set to **Invasive** mode.⁶⁸

⁶⁷ On the ventilator display, the text HiFlowO2 is shown, but on the HAMILTON-H900 humidifier, HiFlow is shown.

⁶⁸ Supported for HAMILTON-H900 version 1.10x and later. If using an older version of humidifier, when treating the patient using HiFlowO2 therapy, the humidifier uses the same temperature and humidity specifications as the humidifier's Invasive mode.

Depending on the selected humidification mode, you can set controls automatically or manually:

- The humidifier supports invasive and noninvasive ventilation modes, as well as high flow oxygen therapy, for which you can use either automatic (Auto) or manual settings.
- Any time the humidifier changes from one mode to another, it also automatically switches to Auto settings and loads the configured default settings for the newly selected humidification mode.

For details about Auto and Manual control settings, see Section 12.1.2.1.

Further, the humidifier matches the operating status of the ventilator. If ventilation is active, the humidifier is running. If the ventilator is in Standby, the humidifier automatically enters Standby.

Note that if the humidifier is turned off and the ventilator is still on, starting ventilation will *not automatically* start the humidifier. The humidifier must be turned on manually. See Section 12.1.5.

12.1.2.1 Auto and Manual control settings

The water chamber exit temperature and temperature gradient are set using either of the following methods:

- Loaded from the configured default settings on the humidifier (Auto mode)
- Set manually by the operator (Manual mode)

When set to Auto, the temperature controls in the System > Humidifier window are disabled. You must first enable Manual mode to change any settings.

In both cases, the humidifier automatically controls the temperatures to reach the specified settings.

Automatic settings (Auto)

When set to Auto, the humidifier loads the associated default settings specified for the selected humidifier mode in its configuration and uses them to control the gas temperature.

In Auto mode, the temperature controls in the ventilator System > Humidifier window are grayed out (disabled), but they display the configured Auto settings (Figure 12-2 and Figure 12-3).

For details about these settings, see the *HAMILTON-H900 Instructions for use*.

Figure 12-2. Auto mode, Invasive humidification

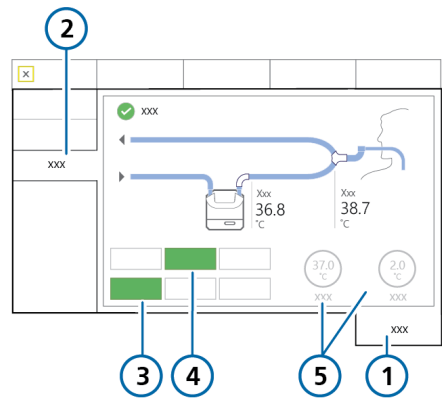

- | | |
|---------------------------------|--|
| 1 System | 4 Auto |
| 2 Humidifier | 5 Disabled controls showing the configured Auto temperature settings |
| 3 Current mode (Invasive shown) | |

Figure 12-3. Auto mode, HiFlowO2 humidification

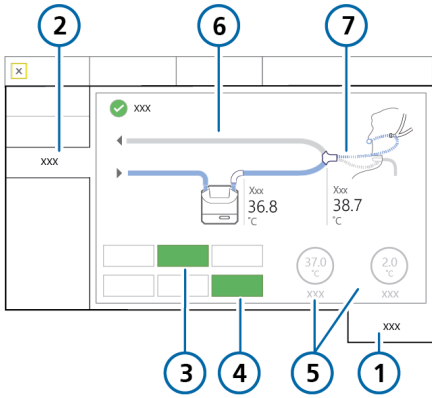

- 1 System
- 2 Humidifier
- 3 Auto
- 4 Current mode (HiFlowO2 shown)
- 5 Disabled controls showing the configured Auto temperature settings
- 6 Expiratory limb, optional
- 7 Nasal cannula or tracheostomy

Manual settings

When set to **Manual**, you set controls as follows:

- *Invasive, NIV*: Set temp, T gradient
- *HiFlow*: Set temp

Table 12-3 describes these controls.

The temperature controls in the ventilator **System > Humidifier** window are enabled (Figure 12-4).

You can change settings both in the **System > Humidifier** window as well as directly on the humidifier. When you

change values on the humidifier, the values are also reflected on the controls in the **System > Humidifier** window.

Figure 12-4. Manual mode, Noninvasive (NIV) humidification

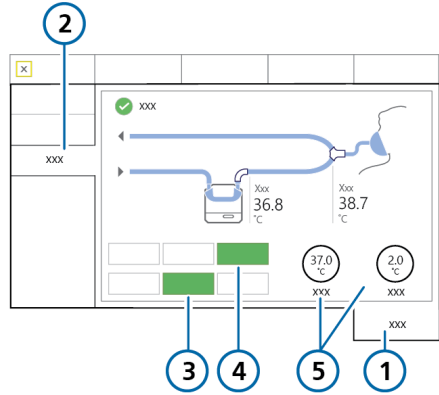

- 1 System
- 2 Humidifier
- 3 Current mode (NIV shown)
- 4 Manual
- 5 Available temperature controls

12.1.3 Changing humidity using temperature controls

You can adjust the following controls on either device:

Table 12-3. Adjustable humidifier controls

Control	Description
Set temp	Temperature at the water chamber exit. The possible range of values for this control depends on the selected humidifier operating mode: <i>Invasive</i> , <i>noninvasive (NIV)</i> , or <i>HiFlowO2</i> . Higher values result in higher absolute humidity.

Control	Description
T gradient	<p>The difference between the temperature at the water chamber exit and at the Y-piece.</p> <p>A higher value decreases condensation.</p> <p>Can only be changed in Invasive and NIV modes.</p>
Exp. temperature increase	<p>When selected, the humidifier provides additional heat in the expiratory limb to reduce condensation.</p>



In a way, the **Set temp** and **T gradient** parameters are linked. The maximum allowed temperature at the patient (Y-piece) is 42°C. The combination of the values set for these two parameters cannot exceed this limit.

For example, if **T gradient** is set to 2°C, the highest possible setting for **Set temp** in the **Invasive** mode is 40°C.

Note, however, that the **T gradient** setting takes precedence over the **Set temp** value. For example, if **Set temp** is set to 40°C, you can set **T gradient** to 3°C even though the combination exceeds 42°C. Once the **T gradient** setting is accepted, the **Set temp** value automatically resets to 39°C.

To manually specify humidifier settings

- ▶ Do either of the following:
 - In the **System > Humidifier** window on the ventilator, touch the **Manual** button, then select the desired **Set temp** and **T gradient** values.
 - Change the chamber exit temperature or temperature gradient directly on the humidifier.

The changes are applied immediately.

To reduce condensation in the expiratory limb

- ▶ Increase the expiratory limb temperature by touching the **Exp. temperature increase** button.
- A checkmark indicates it is selected.

For details about working directly on the humidifier, see the *HAMILTON-H900 Instructions for use*.

12.1.4 Entering Standby

The humidifier automatically enters **Standby** mode when the ventilator enters **Standby**.

12.1.5 Turning the humidifier on/off

You can turn the humidifier on or off both from the ventilator and from the device itself.

When you connect the humidifier to the ventilator, the humidifier assumes the same state as the ventilator.

That is, if the ventilator is in **Standby**, the humidifier is as well. If the ventilator is in active ventilation, the humidifier starts operation immediately.

To turn off the humidifier from the ventilator

- ▶ In the **System > Humidifier** window, touch the **Off** button (Figure 12-1).

The **Off** button turns green and all of the controls in the window are disabled. The **Auto** and **Manual** buttons remain available.

To turn the humidifier back on from the ventilator

1. In the System > Humidifier window, touch the **Manual** or **Auto** button to turn on the humidifier (Figure 12-1).
2. Check the settings and adjust, if needed.

When you start ventilation, the humidifier starts automatically. If the humidifier is turned off and you start ventilation, it will not automatically turn on.

12.1.6 About humidifier-related alarms

Humidifier-related alarm messages are indicated in the following locations:

- On the humidifier, graphically
- Alarm message on the ventilator main display
- The **Humidifier** icon changes color (Table 12-2)

The alarms listed here may not be comprehensive. Be sure to review the *HAMILTON-H900 Instructions for use* for details and troubleshooting information.

Figure 12-5. Humidifier-related alarm indicators on ventilator (showing high-priority alarm)

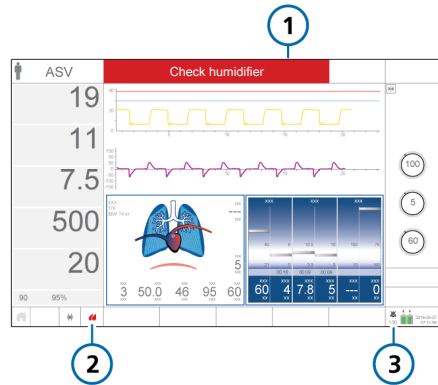

- | | |
|---------------------|-------------------------|
| 1 Alarm message bar | 3 Audio pause indicator |
| 2 Humidifier icon | |



To pause the audible humidifier alarm





- ▶ Touch  (Audio pause) on either the ventilator or the humidifier.

Note that touching the **Audio pause** key on the ventilator also temporarily silences the alarm on the humidifier.

Table 12-4 lists the humidifier-related alarms shown on the ventilator and the associated icon on the humidifier.

Table 12-4. Humidifier alarms

Alarm text on ventilator	Alarm icon on HAMILTON-H900	Description
<i>For detailed information about each alarm and actions to resolve each one, see the HAMILTON-H900 Humidifier Instructions for Use.</i>		
High priority		
Humidifier tilt		<ul style="list-style-type: none"> • Humidifier is at a dangerous angle of incline. • The humidifier is at a 10° angle or higher relative to the floor.
Humidifier chamber temp high Humidifier Y-piece temp high		<ul style="list-style-type: none"> • Temperature too high. • The gas temperature at the water chamber exit or at the Y-piece is above the set value.
Humidifier water high		<ul style="list-style-type: none"> • High water level in the water chamber. • The water level in the water chamber is above the maximum level mark.
Humidifier error	n/a	<ul style="list-style-type: none"> • Check humidifier operation and all connections. • Replace the humidifier and have it serviced. • If a technical fault number is displayed, make a note of it and provide it when the humidifier is serviced.
Check humidifier <i>High, medium, and low priority. Displayed on the ventilator only.</i>	n/a	<ul style="list-style-type: none"> • When the alarm is related to something other than the humidifier alarms listed in this table, the ventilator displays this text. • Check humidifier operation and all connections.

Alarm text on ventilator	Alarm icon on HAMILTON-H900	Description
Medium priority		
Humidifier chamber temp low Humidifier Y-piece temp low		<ul style="list-style-type: none"> • Temperature too low. • The gas temperature at the water chamber exit or at the Y-piece is below the set value.
Humidifier water low		<ul style="list-style-type: none"> • Low water level in the water chamber. • The water level in the chamber is below the low level mark. The water level in the chamber is low.
Humidifier check chamber		<ul style="list-style-type: none"> • No chamber or incompatible water chamber inserted. • The chamber is either missing, incorrectly inserted, or is incompatible.
Humidifier check left tube Humidifier check right tube		<ul style="list-style-type: none"> • No tube or defective tube connected. • A circuit limb is not properly connected.
Low priority		
<p>Check humidifier communication</p> <p><i>Displayed On the ventilator only.</i></p>	<p>The Connection to ventilator symbol is absent.</p>	<p><i>Note that the humidifier information in the ventilator System > Info 2 window is absent, and the Humidifier quick access button is grayed out.</i></p> <ul style="list-style-type: none"> • There is a problem with the connection between the humidifier and the ventilator. • Ensure that the humidifier communication cable is securely connected to the humidifier and to the configured COM port on the ventilator. • Open the alarm buffer by touching the message bar or the i-icon, if displayed, to reset the alarm.

12.1.7 About humidifier-related parameters

Humidifier data is displayed in the following locations:

- **Monitoring > General** window
- **System > Humidifier** window
- As an MMP (if configured)
- As an SMP (if configured)
- **System > Info 2** window

The following parameters are related to humidifier operation.

Table 12-5. HAMILTON-H900-related parameters

Parameter	Description
HAMILTON-H900	Indicates the humidifier is connected, and shows the current software version. Displayed in the System > Info 2 window.
Set temp	Control parameter. See Table 12-3.
T humidifier	Monitored parameter. Measured temperature at the water chamber exit. Displayed in Monitoring > General window and in System > Humidifier window. In Configuration , this parameter can be set as an MMP or SMP.
T gradient	Control parameter. See Table 12-3.

Parameter	Description
T Y-piece	Monitored parameter. Measured temperature at the Y-piece. Displayed in System > Humidifier window. In Configuration , this parameter can be set as an MMP or SMP.
Exp. temperature increase	Control parameter. See Table 12-3.

12.2 Working with IntelliCuff

The ventilator offers integrated monitoring and control of IntelliCuff⁶⁹. IntelliCuff integration is not available with a standalone device.

This integration allows you to view key monitoring data and to control IntelliCuff operation and settings directly from the IntelliCuff window on the ventilator display.

For detailed information about IntelliCuff intended use, setup, operation, and specifications, see the *IntelliCuff Instructions for use*.

For setup details, see Section 4.3.

The following sections describe how to control IntelliCuff from the ventilator.

Table 12-6. IntelliCuff operations available on the ventilator

For details about ...	See ...
Accessing IntelliCuff controls on the ventilator	Section 12.2.1
Turning IntelliCuff on or off	Section 12.2.2
Selecting the settings control mode (Auto/Manual)	Section 12.2.3
Setting the cuff pressure	Section 12.2.4
Performing a hold maneuver	Section 12.2.5
Deflating the cuff	Section 12.2.6

12.2.1 Accessing IntelliCuff controls on the ventilator

The IntelliCuff window displays the cuff pressure setting and current value (Pcuff), as well as the following monitored parameters: VLeak, MVLeak, and Ppeak. It also provides access to the operations listed in Table 12-6.

To open the IntelliCuff window

1. Connect IntelliCuff, including the cuff tubing.
The IntelliCuff window is available when the device is connected, regardless of whether IntelliCuff is turned on or off.
2. Open the IntelliCuff window by doing either of the following:
 - Touch the **IntelliCuff** icon (Section 12.2.1.1)
 - Touch **System > IntelliCuff**.

⁶⁹ Supported for IntelliCuff version 1.0.2.2 and later.

Figure 12-6. System > IntelliCuff window

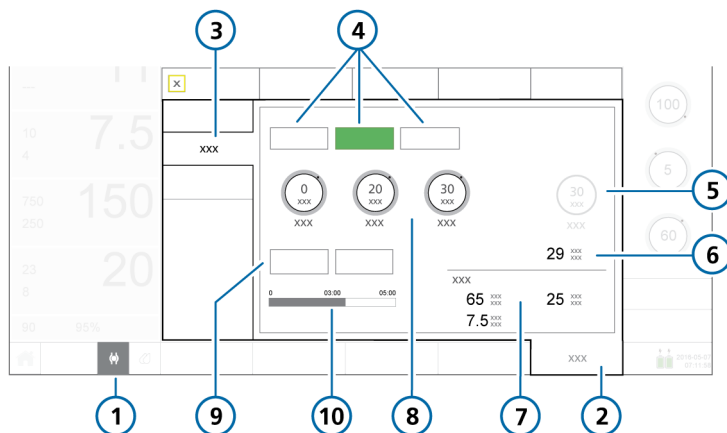





- | | | | |
|---|---|----|---|
| 1 | IntelliCuff icon | 6 | Pcuff |
| 2 | System | 7 | Ventilation monitoring: VLeak, MVLeak, Ppeak |
| 3 | IntelliCuff | 8 | Pressure controls: Relative (Rel. pressure), Minimum (Min. pressure), Maximum (Max. pressure) |
| 4 | Off, Auto, Manual | 9 | Deflate and Hold |
| 5 | Cuff pressure control (labeled <i>Hold pressure</i> when a hold is in progress) | 10 | Hold timer progress bar |

12.2.1.1 About the IntelliCuff button

The **IntelliCuff** button at the bottom left of the display provides quick access to the IntelliCuff window and indicates the state of the controller, including whether any alarms are active.

Table 12-7. IntelliCuff button icon states

Icon state	Description
	<i>Grayed out.</i> IntelliCuff is not connected.
	<i>Cuff is empty.</i> IntelliCuff is connected, turned off. If IntelliCuff is off or deflated and a high- or medium-priority alarm occurs, this icon is shown in the same color as the alarm priority (red or yellow).
	<i>White.</i> IntelliCuff is connected, operational.
	<i>Yellow.</i> IntelliCuff is connected and a low- or medium-priority IntelliCuff-related alarm is active.
	<i>Red.</i> IntelliCuff is connected and a high-priority IntelliCuff-related alarm is active.

12.2.1.2 Verifying connection status

When communication is established between IntelliCuff and the ventilator, the active connection status is displayed on both devices: the IntelliCuff icon on the ventilator display (Table 12-7), and the  **Link** (Connection to ventilator) symbol on IntelliCuff become active.

12.2.2 Turning IntelliCuff on and off

The built-in IntelliCuff is always connected, but must be turned on or off from the IntelliCuff window on the ventilator.

By default, the device is off when starting the ventilator and setting up a new patient⁷⁰.

When choosing the **Last patient** setting in **Standby**, all IntelliCuff controls (**Cuff pressure**, **Rel. pressure**, **Min. pressure**, **Max. pressure**, and the selected mode) are set to the last-used selections. Note that if IntelliCuff is turned off and restarted, the default settings are used instead.

Before turning off the ventilator, you must deflate the cuff and turn off IntelliCuff.

⁷⁰ *Exception.* If you set up a new patient without first turning off IntelliCuff from previous use, the ventilator generates the **Cannot turn off IntelliCuff** alarm when you touch **Adult/Ped** or **Neonatal** in the **Standby** window. Be sure to deflate and turn off IntelliCuff before setting up a new patient.

To turn IntelliCuff ON from the ventilator

- ▶ In the **System > IntelliCuff** window, touch **Auto** or **Manual** (Section 12.2.3).

IntelliCuff starts with the settings as specified.

To turn IntelliCuff OFF from the ventilator

1. In the **System > IntelliCuff** window, touch **Deflate** (Section 12.2.6) or disconnect the cuff tubing. Attempting to turn off IntelliCuff before deflating or disconnecting the cuff generates the **Cannot turn off IntelliCuff** alarm.
2. Within 1 minute of cuff deflation, touch **Off**. If the cuff is deflated or disconnected, IntelliCuff turns off. If you do not turn off the device within 1 minute of deflation, the ventilator generates the **Cuff deflated** alarm. In this case, either touch **Off** or reinflate the cuff by touching **Auto** or **Manual** to continue use.

12.2.3 About IntelliCuff modes

The HAMILTON-C6 ventilator offers the ability to control the cuff pressure manually or automatically.⁷¹

To select the mode to use

- ▶ In the **System > IntelliCuff** window, touch **Auto** or **Manual** (Figure 12-6).

12.2.3.1 Manual mode

In **Manual** mode, you set the desired cuff pressure directly (Section 12.2.4). IntelliCuff maintains this pressure at a constant rate independent of the current airway pressure.

During recruitment maneuvers, the cuff pressure is set automatically (Section 12.2.4.2).

Figure 12-7. System > IntelliCuff window, Manual mode

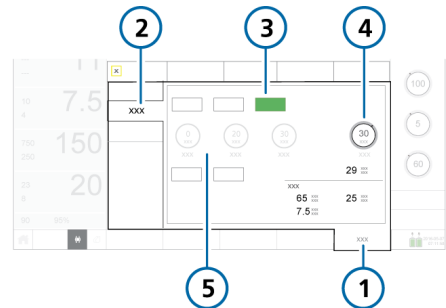

- | | |
|---------------|--|
| 1 System | 4 Cuff pressure control |
| 2 IntelliCuff | 5 Disabled controls showing the configured Auto pressure settings |
| 3 Manual | |

⁷¹ Automatic control is available only from the ventilator IntelliCuff window; it is not available directly on the IntelliCuff device.

12.2.3.2 Auto mode

In **Auto mode**⁷², the device adjusts cuff pressure dynamically to remain at the desired pressure within the set limits.

You specify the desired cuff pressure relative to the monitored peak pressure (**Ppeak**). The value you set is added to **Ppeak** to define the desired cuff pressure.

Cuff pressure = Ppeak + Rel. pressure

You also specify the maximum and minimum pressure limits, as described next.

Figure 12-8. System > IntelliCuff window, Auto mode

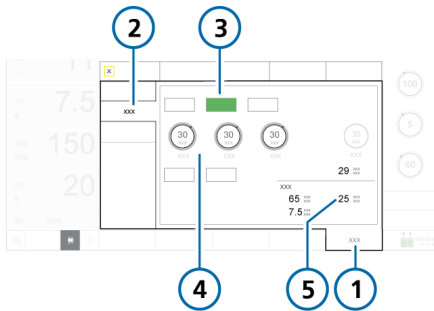

- | | |
|---------------|-------------------------------|
| 1 System | 4 Available pressure controls |
| 2 IntelliCuff | 5 Ppeak |
| 3 Auto | |

12.2.4 Setting the cuff pressure

The process for setting cuff pressure differs between **Manual** and **Auto** modes.

To set the cuff pressure from the ventilator in **Manual** mode

- ▶ In the **System > IntelliCuff** window, touch the **Cuff pressure control**, and set it to the desired value. See Figure 12-7.

IntelliCuff immediately starts adjusting the pressure to this setting, and maintains it at a constant level.

To set the cuff pressure from the ventilator in **Auto** mode

1. In the **System > IntelliCuff** window, touch the **Rel. pressure control** and set it to the desired value. See Figure 12-8.

The set value is added to the **Ppeak** setting, resulting in the delivered cuff pressure.

For example, by setting **Rel. Pressure** to 5 cmH₂O with a **Ppeak** setting of 20 cmH₂O, the maintained cuff pressure (**Pcuff**) is 25 cmH₂O.

2. Touch the **Min. pressure** and **Max. pressure** controls to set the minimum and maximum pressures to apply, respectively.

IntelliCuff immediately starts adjusting the pressure to these settings.

⁷² Auto mode is not available when using high flow oxygen therapy (HiFlowO2).

12.2.4.1 About the Min./Max. pressure control settings

The **Min. pressure** and **Max. pressure** controls have the following upper and lower limits.

Table 12-8. IntelliCuff Auto mode control setting limits

Control	Lower limit	Upper limit
Min. pressure	15 cmH ₂ O	Current Max. pressure setting
Max. pressure	Current Min. pressure setting	50 cmH ₂ O ⁷³

You can set the **Min. pressure** control below the lower limit, if desired.

To set Min. pressure below 15 cmH₂O

1. Touch the **Min. pressure** control and set it to the minimum allowed value of 15 cmH₂O.
2. Press the **P&T** knob to accept the setting.
3. To set the parameter below this limit, touch the control again and turn the **P&T** knob to set the value as desired.
4. Press the **P&T** knob to accept the setting.

The **Min. pressure** control is displayed in orange, indicating that the control is set to a value below 15 cmH₂O.

12.2.4.2 Cuff pressure during a recruitment maneuver

NOTICE

- Recruitment maneuvers are only possible when IntelliCuff is in **Auto** mode.
- When performing a recruitment maneuver, cuff pressure is automatically set for the duration of the event.

During a recruitment maneuver, either using the P/V Tool or as part of INTELLIVENT-ASV auto-recruitment, cuff pressure is set as shown in Table 12-9.

Table 12-9. Cuff pressure during recruitment maneuver

Recruitment maneuver performed in...	Cuff pressure setting (set by device, nonadjustable)
P/V Tool	The highest of: <ul style="list-style-type: none"> • Ptop + 5 cmH₂O⁷⁴ • Previous cuff pressure setting
INTELLIVENT-ASV auto-recruitment	The highest of: <ul style="list-style-type: none"> • Auto-recruitment pressure + 5 cmH₂O⁷⁴ • Previous cuff pressure setting

⁷³ When performing a hold maneuver, the maximum allowed pressure is 55 cmH₂O.

⁷⁴ The maximum allowed pressure is defined in IntelliCuff Configuration.

12.2.5 Performing a hold

A hold temporarily increases the cuff pressure by a specified amount for a set period of time to completely seal the airway and prevent aspiration.

By default, the hold is active for 5 minutes, and applies 5 cmH₂O above the currently set pressure. This setting is defined in IntelliCuff Configuration.

For details, see the *IntelliCuff Instructions for use*.

To perform a hold from the ventilator

- ▶ In the System > IntelliCuff window, touch **Hold**.

The pressure increases to the preset value shown in the Hold pressure control. The hold timer bar in the window shows the total hold time, and a progress bar counts down the time remaining.

The hold continues for the defined time even if the System > IntelliCuff window is closed. Once the hold is complete, IntelliCuff returns to the previously set mode (Auto or Manual).

Figure 12-9. IntelliCuff hold

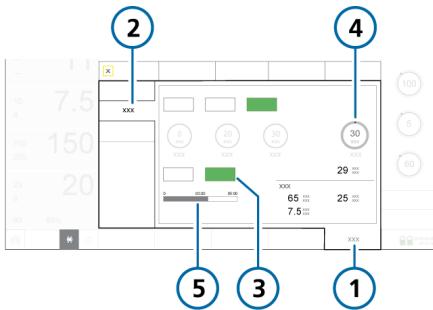

- | | |
|---------------|---------------------------|
| 1 System | 4 Hold pressure |
| 2 IntelliCuff | 5 Hold timer progress bar |
| 3 Hold | |

To cancel an ongoing hold from the ventilator

- ▶ In the System > IntelliCuff window, touch **Auto** or **Manual** to return to normal operation.

At the end of the configured time

- The Intellicuff device beeps
- The **Hold** button on the ventilator turns gray and the hold bar is cleared
- The pressure returns to the pre-hold target pressure

12.2.6 Deflating the cuff

Before turning off IntelliCuff or the ventilator, you must first deflate the cuff. Once it is deflated, you can turn off the device.

To deflate the cuff from the ventilator

1. In the System > IntelliCuff window, touch **Deflate** (Figure 12-6).
2. When prompted to confirm deflation, touch **Yes**.

The pressure in the cuff is released. When the cuff is fully deflated, the Pcuff value is 0.

To turn off IntelliCuff, see Section 12.2.2.

12.2.7 About IntelliCuff-related alarms

Active IntelliCuff-related alarms associated with the built-in cuff pressure controller are indicated in the following locations:

- Alarm message on the ventilator main display
- The **IntelliCuff** icon changes color (Table 12-7)

Figure 12-10. IntelliCuff-related alarm indicators on ventilator (showing medium-priority alarm)

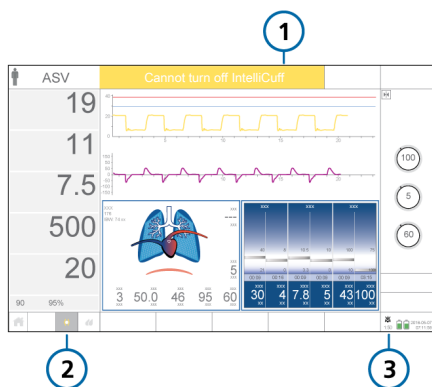

- | | |
|---------------------|-------------------------|
| 1 Alarm message bar | 3 Audio Pause indicator |
| 2 IntelliCuff icon | |

To pause the audible IntelliCuff alarm

- ▶ Touch  (Audio pause) on the ventilator (Figure 10-2).

Table 12-10 lists the IntelliCuff-related alarms shown on the ventilator.

Table 12-10. IntelliCuff alarms

Alarm text on ventilator	Description/Actions
<p>Cuff leak <i>High priority.</i></p>	<p>The cuff loses pressure or is not properly connected.</p> <p>Actions</p> <ul style="list-style-type: none"> • Check the cuff connections on the ventilator. • Check the cuff pressure tube, ET tubing, all cuff connections. • Change the ET tube, if needed. • Have the ventilator serviced to remove and replace IntelliCuff.
<p>Check IntelliCuff <i>High, medium, and low priority.</i></p>	<p>When the alarm is related to something other than the IntelliCuff alarms listed in this table, the ventilator displays the alarm message, Check IntelliCuff.</p> <p>Actions</p> <ul style="list-style-type: none"> • Check IntelliCuff operation, alarm status, and all connections. • Have the ventilator serviced to remove and replace IntelliCuff.
<p>Cuff deflated <i>Medium priority.</i></p>	<p>The cuff has been deflated for over 1 minute.</p> <p>Actions</p> <p>Do either of the following, as appropriate:</p> <ul style="list-style-type: none"> • Disconnect the cuff and turn off IntelliCuff. • Reinflate the cuff by selecting Auto or Manual mode in the System > IntelliCuff window.
<p>Cuff pressure high <i>Medium priority.</i></p>	<p>The pressure has been above the set cuff pressure for 2 or more seconds and cannot be reduced.</p> <p>Actions</p> <ul style="list-style-type: none"> • Check the cuff connections on the ventilator. • Check the cuff pressure tube, ET tubing, all cuff connections. • Change the ET tube, if needed. • Have the ventilator serviced to remove and replace IntelliCuff.
<p>Cannot turn off IntelliCuff <i>Medium priority.</i></p>	<p>The cuff is still inflated while you are trying to turn off IntelliCuff.</p> <p>Actions</p> <p>Deflate the balloon or disconnect the cuff from the ET tube before turning off IntelliCuff.</p>

Alarm text on ventilator	Description/Actions
<p>Check IntelliCuff state <i>Medium priority.</i></p>	<p>Either of the following has occurred:</p> <ul style="list-style-type: none"> • You have connected an inflated cuff with a pressure of 5 cmH₂O or more, but did not turn on IntelliCuff. For example, the patient is being ventilated and you have connected IntelliCuff to a tracheal cuff and to the ventilator, but did not turn on IntelliCuff. • You are attempting to turn off the ventilator while IntelliCuff is running. <p>When this alarm is generated, IntelliCuff automatically turns on and operates in Manual mode using the default settings.</p> <p>Actions</p> <ul style="list-style-type: none"> • If you wish to leave IntelliCuff in operation: <ul style="list-style-type: none"> – Confirm the alarm by entering and exiting the Alarms > Buffer window. – Adjust IntelliCuff mode and settings, as desired. • If you wish to turn off the ventilator: <ul style="list-style-type: none"> – Either deflate the cuff or disconnect the cuff pressure tubing. – Turn off IntelliCuff. – If required, manually control the cuff pressure.
<p>Check IntelliCuff communication <i>Low priority.</i></p>	<p>The ventilator has not received a signal from IntelliCuff for more than 3 seconds. IntelliCuff continues to run and the cuff pressure is maintained, but the IntelliCuff window is not available.</p> <p><i>Note that the IntelliCuff information in the ventilator System > Info 2 window is absent, and the IntelliCuff quick access icon is grayed out.</i></p> <p>Actions</p> <ul style="list-style-type: none"> • Disconnect and reconnect the IntelliCuff communication cable. • Manually maintain the cuff pressure as approved by your institution's protocol. • Open the alarm buffer by touching the message bar or the i-icon, if displayed, to reset the alarm. • Have the ventilator serviced to remove and replace IntelliCuff.

12.2.8 About IntelliCuff-related parameters

The following control and monitoring parameters are used when IntelliCuff is operating.

Table 12-11. IntelliCuff-related parameters

Parameter	Description
IntelliCuff	Shows the current software version. Displayed in the System > Info 2 window.
Cuff pressure (cmH2O)	Control in Manual mode to set the cuff pressure. During a hold maneuver, displays the Hold pressure setting.
Min. pressure (cmH2O)	Control in Auto mode to set the minimum cuff pressure.
Max. pressure (cmH2O)	Control in Auto mode to set the maximum cuff pressure.
MVLeak (l/min)	Monitored total minute volume leakage. See Table 8-4 Displayed in: <ul style="list-style-type: none"> • IntelliCuff window • Monitoring window • Main monitoring parameter (MMP), optional • Secondary monitoring parameter (SMP), optional

Parameter	Description
Pcuff (cmH2O)	Monitored cuff pressure. Displayed in: <ul style="list-style-type: none"> • IntelliCuff window • Monitoring window • Dynamic Lung panel • Main monitoring parameter (MMP), optional • Secondary monitoring parameter (SMP), optional
Ppeak (cmH2O)	Peak airway pressure. See Table 8-4. Displayed in: <ul style="list-style-type: none"> • IntelliCuff window • Monitoring window • Main monitoring parameter (MMP), optional • Secondary monitoring parameter (SMP), optional
Rel. pressure (cmH2O)	Control in Auto mode to set the relative pressure, that is, the pressure above Ppeak to achieve the desired cuff pressure.
VLeak (%)	Monitored leakage in percent. See Table 8-4 Displayed in: <ul style="list-style-type: none"> • IntelliCuff window • Monitoring window • Main monitoring parameter (MMP), optional • Secondary monitoring parameter (SMP), optional

12.2.9 Last Patient settings with IntelliCuff

When using the **Last Patient** selection, the following IntelliCuff settings are in effect:

- If the device was turned on, it remains on.
- The last selected IntelliCuff mode (**Auto** or **Manual**)
- The last specified pressure settings

13

Maintenance

13.1	Overview.....	278
13.2	Cleaning, disinfection, and sterilization	278
13.3	Preventive maintenance	282
13.4	Performing maintenance tasks	283
13.5	Repacking and shipping	285

13.1 Overview

Before proceeding, review the safety information in Chapter 1.

This chapter provides information about ventilator maintenance procedures and schedule, as well as cleaning and disinfection instructions.

All of the procedures in this chapter are to be performed by the operator.

For additional maintenance requirements, contact your Hamilton Medical service representative. Any documents referenced in this chapter are available on the MyHamilton website: <https://www.hamilton-medical.com/MyHamilton>

13.2 Cleaning, disinfection, and sterilization

Ventilator components must be regularly cleaned and disinfected, using the cleaning methods and solutions specific to the individual components.

It is important that you use the appropriate method and materials when cleaning and disinfecting the ventilator and its components, not only to avoid damaging the equipment, but also to avoid cross-contamination.

Cleaning and disinfection information is presented as follows:

- Table 13-1 lists the applicable ventilator-related components, and indicates which cleaning and disinfection methods can be used for each one, the frequency with which the component must be cleaned/disinfected, and any other relevant information.
- Table 13-2 provides cleaning and disinfection information for ventilator-compatible external devices and sensors.
- Table 13-3 lists the supported cleaning and disinfection agents, as well as the concentration to be used for the ventilator.
- Table 13-4 lists the supported cleaning and disinfection agents for the CO₂ sensors.

When working with the ventilator components, cleaning methods, and cleaning agents, keep the following in mind:

- Do *not* attempt decontamination procedures unless specified by Hamilton Medical or the original manufacturer.
- While we provide guidelines for agents and concentrations to use, if you have specific questions about the use of a particular cleaning or disinfection agent, contact the manufacturer of the agent.
- After cleaning and decontaminating parts, be sure to perform any required tests and calibrations described in Chapter 5.

Table 13-1. Ventilator cleaning and disinfection methods

Part	Frequency	Cleaning/disinfection method	Remarks
<i>For supported cleaning and disinfection agents, see Table 13-3.</i>			
Ventilator exterior including: <ul style="list-style-type: none"> • Housing • Power cables • Gas supply hoses • Mounting systems 	After each patient use or as needed.	Wipe with a damp cloth using a registered and approved cleaning/disinfection solution.	Do not clean the ventilator interior to avoid damaging internal components.
Touch screen	After each patient use or as needed.	Wipe with a damp cloth using a registered and approved cleaning/disinfection solution or a nonabrasive glass cleaner.	<ul style="list-style-type: none"> • Lock the touch screen before cleaning. See Section 10.8. • Do not use any vinegar based solutions. • Avoid using a gritty cloth.
Trolley-related accessories including: <ul style="list-style-type: none"> • Trolley • Basket • O2 cylinder holding system 	After each patient use or as needed.	Wipe with a damp cloth using a registered and approved cleaning/disinfection solution.	
Autoclavable expiratory valve	After each patient use or as needed.	Clean and sterilize according to the instructions in the <i>Expiratory Valve Reprocessing Guide</i> (PN 624591).	For details about assembly, installation, and disassembly of the expiratory valve, see Section 3.4.2.
CO2 sensors	After each patient use or as needed.	Wipe with a damp cloth using a registered and approved cleaning/disinfection solution (Table 13-4). Dry before use.	<ul style="list-style-type: none"> • Ensure that the module/sensor is disconnected and cooled to room temperature before cleaning. • Do not immerse the module/sensor in liquid.

Table 13-2. Cleaning and disinfection methods for external devices

Device	Frequency	Remarks
IntelliCuff	After each patient use or as needed.	Refer to the <i>IntelliCuff Instructions for Use</i> .
HAMILTON-H900 humidifier	After each patient use or as needed.	Refer to the <i>HAMILTON-H900 Instructions for Use</i> .
Third-party humidifiers	After each patient use or as needed.	Refer to the humidifier <i>Instructions for Use</i> .
SpO2 sensors	After each patient use or as needed.	Refer to the <i>Pulse Oximetry Instructions for Use</i> and the sensor manufacturer's <i>Instructions for Use</i> .
Aerogen nebulizer	After each patient use or as needed.	Refer to the <i>Aerogen Solo/Pro Instructions for Use</i> .

Table 13-3. Cleaning/disinfection agents for the ventilator

Cleaning/disinfection agent	Concentration
EPA-registered cleaning/disinfection agents	
Sani-Cloth Active wipes	n/a
Approved cleaning/disinfection agents	
Mikrobac Tissues wipes	n/a
mikrozid sensitive wipes	n/a
mikrozid AF liquid	Ready for use
Bacillol 30 Sensitive Foam	Ready for use
Ethanol	--
Incidin Foam	Ready for use
Incidin Pro	0.25% to 4%
Incidin Rapid	0.25% to 2%
Isopropyl alcohol	--
Mikrobac forte	0.25% to 4%
perform	3%
terralin protect	2%

Table 13-4. Cleaning/disinfection agents for CO2 sensors

Cleaning/disinfection agent	LoFlo (sidestream)	CAPNOSTAT 5 (mainstream)
EPA-registered cleaning/disinfection agents		
Steris Coverage Spray	X	X
PDI Sani Cloth Bleach		X
PDI Sani Cloth AF		X
Approved cleaning/disinfection agents		
Ammonia	X	
2% glutaraldehyde solution	X	
Isopropyl alcohol 70%	X	X
A 10% aqueous solution of chlorine bleach	X	X
Clinell Wipes		X
Speedy Clean		X
Tuffie		X
Tuffie 5		X
WIP Anios		X

13.3 Preventive maintenance

Perform preventive maintenance on your ventilator according to the schedule shown in Table 13-5.

The **System > Info** window shows the number of hours the ventilator has been in operation.

Table 13-5. Preventive maintenance schedule

Interval	Part/accessory	Procedure
Between patients and according to hospital policy	Breathing circuit (including mask, inspiratory or expiratory filter, flow sensor, nebulizer jar, expiratory valve set)	Replace with sterilized or new single-patient use parts and run the preoperational checks (Section 5.4).
	Entire ventilator	Run the preoperational checks (Section 5.4).
Every month (or more often if required)	Fan filters (rear panel and on the bottom of the device), air intake filters (white filters on outside of HEPA filter)	Check for dust and lint. If needed, replace. See Section 13.4.1.
Every 6 months	Batteries	Recharge batteries by plugging the ventilator into a primary power source for at least 4 hours.
Yearly or as necessary	Galvanic O2 sensor	Replace if depleted. See Section 13.4.3.
	Air intake HEPA filter	Replace. See Section 13.4.1.
	Ventilator	Perform service-related preventive maintenance. ⁷⁵
	CO2 sensor	If the CO2 option is installed, have a CO2 accuracy check performed. ⁷⁵
Yearly maintenance	IntelliCuff connection port ⁷⁶	Perform service-related preventive maintenance. ⁷⁵

For the HAMILTON-H900 Humidifier, see the *HAMILTON-H900 Service Manual*.

⁷⁵ Must be performed by Hamilton Medical authorized service personnel according to instructions in the *Service Manual*.

⁷⁶ The IntelliCuff device itself is maintenance free or should be maintained according to your institution's protocols. The port must be serviced annually.

13.4 Performing maintenance tasks

The following sections describe how to clean and replace filters, batteries, and a galvanic O2 sensor.

13.4.1 Maintaining the filters

Replacing air and HEPA filters

Figure 13-1. *Step 1.* Remove back cover.

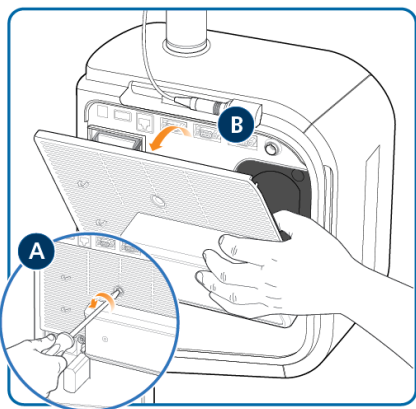

Figure 13-2. *Step 2.* Release filter clip (A). Remove and replace air filters (B). Remove and replace HEPA filter (C).

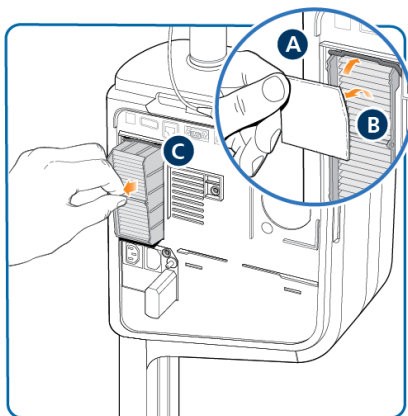
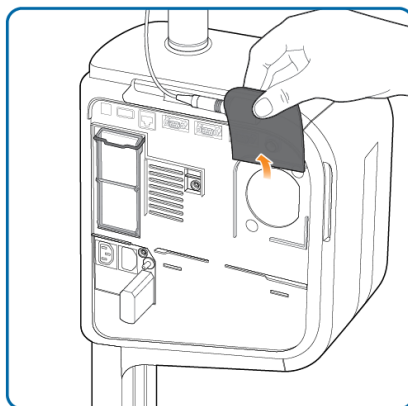

Figure 13-3. *Step 3.* Remove and replace fan filter.



Replacing the bottom dust filter

Figure 13-4. *Step 1.* Pinch the clasp (A) and pull down the cover (B).

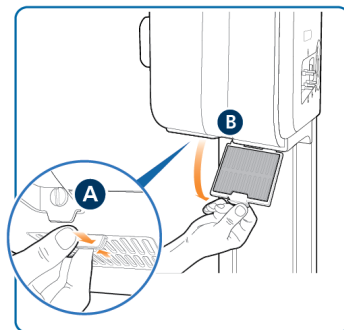
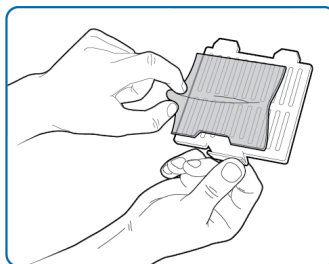

Figure 13-5. *Step 2.* Remove and replace the filter.



13.4.2 Removing the side cover

Removing the side cover provides access to the O₂ sensor and ventilator batteries.

Figure 13-6. Remove the screw (A). Lift up and remove the side cover (B).

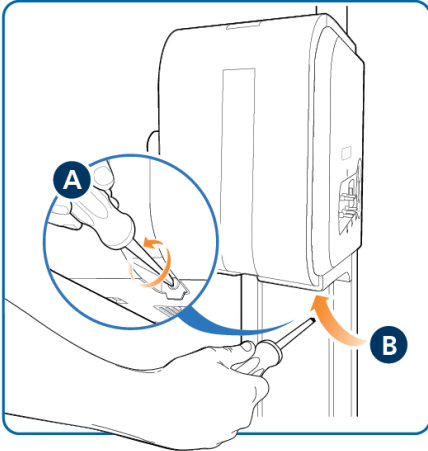
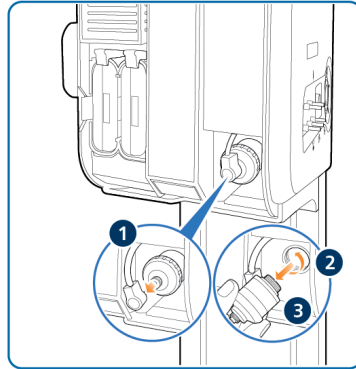

Figure 13-7. Remove connection cable (1). Unscrew sensor counterclockwise (2) and remove (3).



13.4.3 Replacing the galvanic O₂ sensor

Before proceeding, review the safety information in Chapter 1.

Remove the side cover first (Section 13.4.2).

To replace the sensor, reverse the steps.

13.4.4 Charging and storing batteries

To maintain the battery charge and to prolong the life of the battery, keep the ventilator connected to its primary power source.

Have the battery recharged every 6 months, depending on storage conditions. For details, see Section 16.4.

13.4.5 Replacing batteries

Figure 13-8. Push up retaining clip (A).
Exchange battery (B).

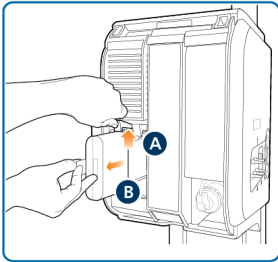

13.5 Repacking and shipping

CAUTION

Inform Hamilton Medical if you are shipping a contaminated (nonsterilized and nondisinfected) device for service.

If you must ship the ventilator, use the original packing materials. If these materials are not available, contact your Hamilton Medical representative for replacement materials.

14

Configuration

14.1	Overview.....	288
14.2	Accessing Configuration mode.....	288
14.3	Configuring general settings	288
14.4	Selecting mode options.....	290
14.5	Configuring MMPs and SMPs.....	291
14.6	Defining Quick setups	291
14.7	Activating Aerogen	293
14.8	Activating SpO2 and CO2 measurement	293
14.9	Copying configuration settings.....	293
14.10	Configuring device options	293

14.1 Overview

During configuration, you set up the ventilator with a default language, main monitoring parameter display, startup settings for a new patient, and units of measure, among other settings.

14.2 Accessing Configuration mode

You can access all Configuration mode settings when the ventilator is in **Standby**. Access requires a configuration code; contact your administrator.

To access Configuration mode

1. Touch **Tools** > **Configuration**.
2. Using the keys on the onscreen keypad, type the configuration code; then touch **Enter**.
The **Configuration** button is enabled.
3. Touch **Configuration**.

The **Configuration** window appears, displaying the **Language** window.

You can now define settings and add options.

14.3 Configuring general settings

You can configure some general default settings for the ventilator, including language, units of measure, communication interface to use, and minimum loudness for alarms.

14.3.1 Selecting the default language

To select the user interface language

- ▶ Touch **General** > **Language** and select the desired language.

14.3.2 Selecting the units of measure

To select the units of measure

- ▶ Touch **General** > **Units** and select the unit of measure for pressure, length, and CO₂.

14.3.3 Enabling the communication interface

You can connect external devices to the ventilator using the communication interface. For a list of the communication protocols, see Table 2-2.

For further setup and configuration details, see the *Communication Interface User Guide*, available on MyHamilton.

To select the communication interface

- ▶ Touch **General** > **More** and select the desired communication protocol for the desired COM port.

The COM3 port is preconfigured for the HAMILTON-H900 humidifier and cannot be changed.

For communication with a distributed alarm system (DAS), select the **Hamilton Block (ACK)** protocol for the desired COM port.

14.3.4 Setting the minimum alarm loudness (volume)

You can specify a minimum alarm loudness (volume) setting for the ventilator. Once set, the ventilator operator cannot set the alarm volume below the value set here in **Configuration**.

To set the minimum alarm loudness

1. Touch **General** > **More**.
2. Touch the **Min. loudness** button and choose the minimum alarm volume to allow on the device.

The setting is applied to the ventilator. Note that if the new minimum is greater than the currently set alarm volume, the alarm volume is reset to the new minimum level.

To verify the setting, check the **Loudness** value in the **System** > **Settings** window.

14.3.5 Setting sensitivity for Check flow sensor for water alarm

Applicable for Neonatal patients only.

Under certain conditions, water may accumulate in the flow sensor, which can result in overstated volume measurements.

You can set how sensitive the alarm trigger for water in the flow sensor is. *Sensitivity* refers to the deviation from the dry value that the flow sensor tolerates before the ventilator generates the **Check flow sensor for water** alarm. By default, sensitivity is set to 12%. You can also turn off the alarm.

To set the flow sensor sensitivity

1. In **Configuration**, touch **General** > **More**.
2. Activate the **FS alarm sensitivity** control and set it to the desired value.
Increasing the value lowers sensitivity; decreasing the value increases sensitivity.

14.3.6 Setting oxygen alarm limits manually

By default, the **Oxygen** high/low alarms are automatically set to the current **Oxygen** setting \pm 5% and cannot be manually adjusted.

To enable manual adjustment of Oxygen alarm limits

1. Touch **General** > **More**.
2. Touch the **Set Oxygen alarm limits manually** checkbox.

The **Oxygen** alarm limits are enabled in the **Alarms** > **Limits 2** window and can be set manually.

14.3.7 Setting the maximum available Flow in HiFlowO2 for neonates

You can specify the maximum Flow that can be set in HiFlowO2 for neonatal patients. Once set, the ventilator operator cannot set Flow above the value set here in Configuration.

To specify the maximum Flow setting in HiFlowO2 for neonates

1. Touch **General > More**.
2. Touch the **HiFlowO2 limitation** button and choose the maximum setting to allow on the device.

14.4 Selecting mode options

You can set the following:

- Mandatory breath timing philosophy to use for PCV+, APVcmv, (S)CMV, SIMV, PSIMV+, APVsimv, and NIV-ST modes
- Naming convention for volume-controlled, pressure-adaptive modes
- ASV version
- Enable the TI max control for certain invasive modes

14.4.1 Setting breath timing options

The ventilator controls mandatory breath timing using a combination of inspiratory time (TI) and Rate.

For the modes PCV+, APVcmv, (S)CMV, SIMV, PSIMV+, APVsimv, and NIV-ST, you can set the ventilator to use any of the following combinations to control breath timing:

- I:E/Pause
- TI/Pause
- Peak flow/Tip⁷⁷

To change the breath timing selection

- ▶ In the Modes > General > Philosophy window, touch the desired breath timing option.

14.4.2 Choosing the mode naming convention

You can select the naming convention used for adaptive modes:

- APVcmv / APVsimv
- (S)CMV+ / SIMV+

By default, APVcmv/APVsimv are used.

To select the mode naming convention

- ▶ In the Modes > General > Philosophy window, select the desired option.

14.4.3 Choosing the ASV version

By default, the device uses ASV version 1.1. For details about the different ASV versions, see Section 7.5.1.1.

To select the ASV version

- ▶ In the Modes > General > Philosophy window, select the desired version.

⁷⁷ (S)CMV and SIMV modes only; all other modes use TI.

14.4.4 Enabling TI max for invasive modes

In **Configuration**, you can enable or disable the TI max control setting, as desired, for adult/pediatric patients in the following modes: APVsimv, PSIMV+, DuoPAP, and SPONT

To enable/disable TI max

1. Open the **Modes > General > Philosophy** window.
2. Touch the **Available in invasive modes** checkbox to enable/disable the setting.

A checkmark indicates TI max is enabled.

14.5 Configuring MMPs and SMPs

You can specify which MMPs are displayed on the ventilator, as well as which parameters to show in the **Monitoring** panel (Section 8.2.2) as SMPs.

The list of entries in the **Configuration** window is shown in the same order as the MMPs appear on the main display.

Ppeak must always be displayed as an MMP, but you can choose where to display it. By default, it is shown as the top entry.

To select the MMPs to display

1. In **Configuration**, touch **Graphics > MMP**.
2. In each dropdown list, select the desired parameter to display in that position in the MMP list on the main display.

To select the SMPs to display in the Monitoring panel

1. In **Configuration**, touch **Graphics > SMP**.
2. In each dropdown list, select the parameter to show in the **Monitoring** panel.

14.6 Defining Quick setups

A **Quick setup** refers to a group of settings you define, including patient characteristics, mode selection and control settings, alarm limit settings, nebulizer settings⁷⁸, and weaning zone limits.

The settings saved with a **Quick setup** are automatically applied when the setup is selected in the **Standby** window.

For each patient group, you can configure up to three **Quick setups**, and can specify a setup to be selected by default when the ventilator is turned on.

14.6.1 Configuring individual setup settings

To configure a Quick setup

1. In **Standby** mode, configure the ventilator with the parameters you will save as a **Quick setup**.
Select:
 - Patient group and sex/height (**Adult/Ped**) or weight (**Neonatal**)
 - Ventilation mode
 - Mode control settings
 - Alarm limits
 - Humidifier settings
 - IntelliCuff **Auto** settings
 - Nebulizer type, duration, and synchronization setting

⁷⁸ Only for adult/pediatric patients.

2. Touch **Start ventilation** and select the desired graphic layout and graphics to display. See Section 8.3.
3. Return to **Standby**.
4. Access **Configuration** mode.
5. In the **Configuration** window, touch **Setups**, and then touch the button (1, 2, or 3, or your custom-defined labels) for the setup to configure.

The **General setup configuration** window is displayed. Note that the buttons in the left panel now change to provide access to the setup options.

6. Touch **Rename setup** to give the setup a meaningful name.

You must define a name as it is used as the **Quick setup** button label in **Standby**, as well as in this **Configuration** window.

7. Select the configuration settings to apply to this setup by touching the appropriate button:
 - To apply the ventilator settings you selected in step 1, touch **Use current settings**.
 - To apply factory settings, touch **Use factory settings**.
8. Touch **Mode Ctrl** > **Controls** to review patient parameter settings.

Some parameters are not displayed, as they are based on weight:

 - The following parameters are set based on ideal body weight (IBW) (Adult/Ped): Vt, Rate, T low, T high, and TI.
 - The following parameters are set based on body weight (Neonatal): Vt, Rate, T low, T high, TI, and TI max.

9. Touch **Vt/IBW** (Adult/Ped) or **Vt/Weight** (Neonatal) to set the tidal volume per IBW or weight, respectively.

The ventilator uses the **Vt/IBW** or **Vt/Weight** setting in calculations for the following:

- To set the initial delivered Vt in volume-controlled modes
- To set the initial high and low alarm limits for Vt and ExpMinVol

10. Review the alarm settings in the **Alarms** window.
11. In **Vent Status**, set patient parameters manually.

The **Vent Status** window allows you to configure the weaning zone ranges shown in the **Vent Status** panel according to your institution's protocol.

12. Touch the **Back** button to return to the **Default setup** window.

Configuration of the **Quick setup** is complete.

14.6.2 Selecting a default Quick setup

A **Default setup** comprises a group of settings that are automatically loaded when turning on the ventilator.

After you have configured one or more **Quick setups**, select the default to use.

To set a Quick setup as the default

- ▶ In **Configuration**, touch **Setups** and select the setup to use as the default.

14.7 Activating Aerogen

To use an Aerogen nebulizer with the ventilator, you must first activate the Aerogen hardware connection. For details, see Section 14.10.2.

14.8 Activating SpO2 and CO2 measurement

To enable SpO2 and/or CO2 measurement on the ventilator, you must activate the associated hardware option in **Configuration**. See Section 14.10.2.

You must also enable each sensor in the **System** window. See Section 4.6.

14.9 Copying configuration settings

Before proceeding, review the safety information in Chapter 1.

You can copy the configuration settings to a USB drive and quickly transfer the settings to other HAMILTON-C6 devices. For details about configuration settings, ranges, and defaults, see Table 16.8.

If you remove the USB drive before the files are successfully transferred, you must start over and repeat the export.

To copy configuration settings using a USB drive

1. Insert a USB drive into the USB port on the side of the ventilator monitor. See Figure 2-5.
2. In **Configuration**, touch **Transfer**.

3. In the **Transfer** window, touch **Import** or **Export**.

- The device begins transferring the files. A message is displayed after the files are successfully transferred.

- Exported files are stored in the **import-export config** folder on the USB drive.

- Imported configuration files are immediately applied to the ventilator.

If you remove the USB drive before the files are successfully transferred, you must start over and repeat the process.

14.10 Configuring device options

Before use, you must enable any installed hardware options (for example, CO2 and SpO2), and add and enable software options.

14.10.1 Adding software options

Software options are added using license keys.

Trial versions of software options may be available. Trial options expire and are automatically deactivated after 30 days.

Have all required keys available before proceeding.

To add a software option

1. In **Configuration**, touch **Options**.
2. In the **Options** window, touch **SW options**.
3. Touch **Add options**.

4. Type the activation code exactly as provided into the field and touch **Enter**.
If the message *Option code invalid!* appears, re-enter the code.
The message *Option valid* indicates the code is correct and the option has been added.
5. Repeat until all desired software options are added.
6. Touch the **X** to close the window.
7. Restart the ventilator to enable the options.

Upon turning on the ventilator, the added options are available for use.

14.10.2 Activating hardware options

Communication board-related functions (CO2, SpO2, Aerogen) are activated at two levels:

- The hardware itself must be activated in configuration to make the functionality available to the user, described in this section.
- Sensors that plug into the hardware are individually enabled by the user, as needed, in the **System** window. See Chapter 4.

To enable hardware options in Configuration

1. Touch **Options**.
2. In the **Options** window, touch the **HW options** tab.
The window lists hardware that requires activation.
3. Select the checkbox for options to activate.
A green checkmark indicates the option is activated.

Upon exiting **Configuration**, the activated hardware is available for use.

SpO2 and CO2 sensors require an additional step, and must also be enabled in the **System > Sensors** window.

When Aerogen is activated, the **Aerogen** button is available in the **System > Nebulizer** window. You can now choose between Aerogen and pneumatic nebulization.

14.10.3 Removing options

Note the following:

- Trial options are automatically removed at the end of the trial period.
- Selecting **Clear options** removes *all* non-trial options.
- The patient groups on the ventilator, **Adult/Ped** and **Neonatal**, are also treated as options. Clearing options removes them and the associated ventilation modes. You must re-add them before using the ventilator on a patient.

To remove software options

You can remove all non-trial software options from the ventilator.

1. In the **SW options** window, touch **Clear options**.
You are prompted to confirm deletion of all non-trial options. See the previous notes.
2. Touch **Clear options** to remove the options.
Touch **Cancel** to leave the options installed.
3. Restart the ventilator.
Once you restart the ventilator, all options (including patient groups) listed in the window are cleared.

4. To re-add the patient groups and any other desired options, re-enter **Configuration** mode.
5. Add software options (including the patient groups), as appropriate.

14.10.3.1 Deactivating hardware options

To deactivate hardware options

- ▶ In the **HW options** window, clear the checkboxes to deactivate the hardware.

15

Parts and accessories

15.1	Overview.....	298
------	---------------	-----

15.1 Overview

This chapter lists the parts available for the HAMILTON-C6 ventilator. Note that not all parts are available in all markets.

For additional parts and accessories and ordering information, refer to the e-catalog on the Hamilton Medical website or contact your Hamilton Medical representative.

Figure 15-1. Ventilator parts and accessories

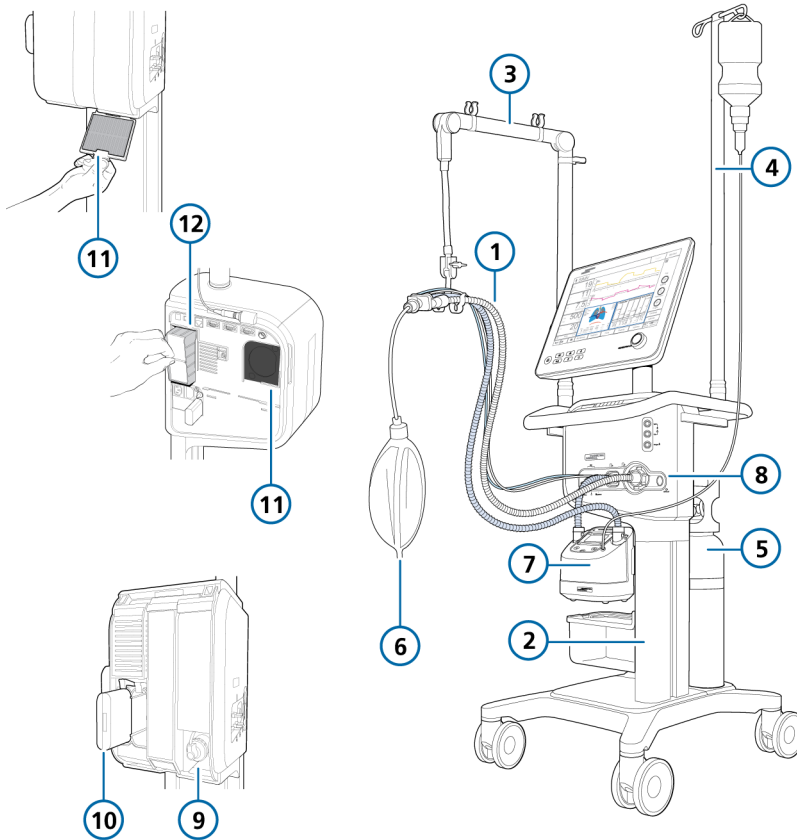

Table 15-1. Ventilator parts and accessories

Item no. (ref to Fig 15-1)	Description	PN
1	HAMILTON-H900 breathing circuit set, adult/pediatric	
	Breathing circuit set BC8022, dual limb, single use, preassembled, box of 15	260161
	Breathing circuit set BC8022-A, dual limb, autoclavable, pre-assembled, box of 1	260188
	Breathing circuit set BC4022, single limb, single use, preassembled, box of 15	260186
	HAMILTON-H900 breathing circuit set, neonatal	
	Breathing circuit set BC8010, dual limb, single use, preassembled, box of 15	260185
	Breathing circuit set BC4010, single limb, single use, preassembled, box of 15	260187
1	Breathing circuit set, coaxial, single use, adult/pediatric	
	Length 1.80 m, box of 20	260206
	Preassembled, with flow sensor, length 1.80 m, box of 20	260207
	Length 2.40 m, box of 10	260239
	Preassembled, with flow sensor, length 2.40 m, box of 10	260240
	Preassembled, with expiratory valve set and flow sensor, length 1.80 m, box of 20	260257
1	Breathing circuit sets, dual limb, single use, neonatal	
	With Y-piece, flow sensor, flow sensor calibration adapter, and pressure line with T-piece connectors, length 1.50 m, box of 20	260180

Item no. (ref to Fig 15-1)	Description	PN
1	Flow sensors, adult/pediatric	
	Flow sensor, single use, adult/pediatric, 1.88 m, box of 10	281637
	Flow sensor, single use, adult/pediatric, 2.60 m, box of 10	282049
	Flow sensor, autoclavable, adult/pediatric, 1.88 m, box of 1	950185
	Flow sensor calibration adapter, single use, adult/pediatric, box of 10	279937
	Flow sensor calibration adapter, autoclavable, adult/pediatric, box of 10	282323
1	Flow sensors, neonatal	
	Flow sensor, single use, neonatal, 1.60 m, box of 10	260177
	Flow sensor, single use, neonatal, 1.88 m, box of 10	155500
	Flow sensor, single use, neonatal, 3.10 m, box of 10	260179
	Flow sensor calibration adapter, single use, neonatal, box of 10	279964
8	Expiratory valve	
	Expiratory valve set, autoclavable, box of 1	160245
	Membrane, expiratory valve, autoclavable, box of 5	160500
	Expiratory valve set, single use, box of 10	160176
<i>not shown</i>	Nasal cannulas, adult⁷⁹	
	In2Flow nasal cannula, size S, OD22 with OD15 adapter, max flow rate: 60 l/min, single use, box of 20	10076606
	In2Flow nasal cannula, size M, OD22 with OD15 adapter, max flow rate: 80 l/min, single use, box of 20	10076605
	In2Flow nasal cannula, size L, OD22 with OD15 adapter, max flow rate: 100 l/min, single use, box of 20	10076604

⁷⁹ Not available in all markets. For other options, see the *Hamilton Medical e-catalog*.

Item no. (ref to Fig 15-1)	Description	PN
<i>not shown</i>	Nasal cannulas, pediatric/neonatal	
	Nuflow nasal cannula set, size S, with OD15 adapter, max flow rate: 10 l/min, single use, box of 10	10072354
	Nuflow nasal cannula set, size M, with OD15 adapter, max flow rate: 14 l/min, single use, box of 10	10072355
	Nuflow nasal cannula set, size L, with OD15 adapter, max flow rate: 23 l/min, single use, box of 10	10072356
	Nuflow nasal cannula set, size XL, with OD15 adapter, max flow rate: 27 l/min, single use, box of 10	10072357
<i>not shown</i>	Masks and accessories, adult/pediatric <i>See the Hamilton Medical e-catalog.</i>	
<i>not shown</i>	Masks and accessories, neonatal	
	nCPAP-PS Starter kit, large (10 sets, incl. mask, prongs, and bonnets)	281975
	nCPAP-PS Starter kit, small (1 set, incl. mask, prongs, and bonnets)	282330
<i>not shown</i>	CO2 mainstream measurement	
	HAMILTON CAPNOSTAT-5 CO2 sensor	281718
	CO2 mainstream airway adapter, single use, adult/pediatric, box of 10	281719
	CO2 mainstream airway adapter, single use, neonatal, box of 10	281720
	CO2 mainstream airway adapter, reusable, adult/pediatric, box of 1	281721
	CO2 mainstream airway adapter, reusable, neonatal, box of 1	281722
	OD15/ID15 adapter, single use, neonatal, box of 25	281803
<i>not shown</i>	CO2 sidestream measurement	
	HAMILTON LoFlo sidestream CO2 sensor	281928
	CO2 sidestream adapter, single use, adult/pediatric, box of 10	281929
	CO2 sidestream adapter, single use, adult/pediatric, box of 10	281931
	CO2 sidestream adapter, single use, neonatal/pediatric, box of 10	281930
	CO2 sidestream adapter, single use, neonatal, box of 10	281932

Item no. (ref to Fig 15-1)	Description	PN
7	Humidifier	
	HAMILTON-H900 humidifier <i>See the Hamilton Medical e-catalog.</i>	
	HAMILTON-H900 Integration kit for HAMILTON-C6	160783
<i>not shown</i>	IntelliCuff	
	IntelliCuff cuff pressure controller <i>See the Hamilton Medical e-catalog.</i>	
	IntelliCuff Integration kit for HAMILTON-C6	160784
2	Trolley	
	Humidifier trolley support	160969
	Basket	160177
	Additional standard rail	160178
3	Tubing support arm, for use with quick lock	160153
4	Water bottle holder with quick lock (max. 1 kg per side)	160162
5	Oxygen cylinder holder (two bottles)	160971
<i>not shown</i>	Bed docking system	10072473
6	Demonstration lung	
	IntelliLung, maximum 1 liter	281869
	Demonstration lung assembly with endotracheal tube, adult, 2 liter, with OD15 connector	151815
	Demonstration lung assembly with endotracheal tube, 0.5 liter, with OD15/OD22 connector (pediatric)	151816
	Demonstration lung, neonatal, OD15 <i>A passive lung simulator with two independent compartments for simulating neonatal patients.</i>	R53353

Item no. (ref to Fig 15-1)	Description	PN
12	Filter	
	Filter set <i>Includes 5 sets. Each set includes 2 air intake dust filters and a fan filter for each fan.</i>	160735
11	Filter, air intake (HEPA)	160216
<i>not shown</i>	Patient filter	
	HME filter (HMEF), single use, adult/pediatric	279963
	HME filter (HMEF), single use, adult/pediatric	279974
	Expiratory bacteria filter	279204
	Inspiratory bacteria filter	279211
<i>not shown</i>	Power cord	
	Power cord with US plug, 2.5 m	355190
	Power cord with British angled plug, 2.5 m	355191
	Power cord with continental European plug, 2.5 m	355192
	Power cord with Swiss plug, 2.5 m	355181
	Power cord with Swiss plug and potential equalization cable (POAG, EU), 3.0 m	10100402
9	Oxygen sensor	
	Galvanic O2 sensor, lead free	10110473
	Galvanic O2 sensor	396200
	Paramagnetic O2 sensor kit	160169
<i>not shown</i>	Communication	
	Extended communication board CO2, SpO2, Aerogen	160184
	Extended communication board CO2, SpO2	160185
	Cable, Nurse Call	160166
10	Battery	
	Li-Ion battery	MSP369130

Item no. (ref to Fig 15-1)	Description	PN
<i>not shown</i>	High-pressure oxygen connector	
	DISS – diameter index safety standard	160470
	NIST – no interchangeable screw thread	160471
<i>not shown</i>	SpO2 sensors and accessories (Masimo and Nihon Kohden) <i>See the Hamilton Medical e-catalog.</i>	
<i>not shown</i>	Aerogen nebulizer, pneumatic nebulizer, and accessories <i>See the Hamilton Medical e-catalog.</i>	
<i>not shown</i>	Tools and test equipment <i>See the Hamilton Medical e-catalog.</i>	
	Ventilator hardware and mounting options <i>See the Hamilton Medical e-catalog.</i>	
	Language kit	
	English	160773
	US-English	10112611
	German	160774
	Spanish	160775
	French	160776
	Russian	160777
	Chinese	160778
	Portuguese	160779
	Extended warranty	
	Extended warranty of 1 year	700111
	Extended warranty of 2 years	700112
	Extended warranty of 3 years	700113
	Extended warranty of 8 years	700118

16

Specifications

16.1	Physical characteristics.....	306
16.2	Environmental requirements.....	308
16.3	Pneumatic specifications	309
16.4	Electrical specifications	310
16.5	Control settings	312
16.6	Monitored parameters	318
16.7	Alarms	326
16.8	Configuration	329
16.9	ASV technical data	332
16.10	Ventilator breathing system specifications	334
16.11	Technical performance data	335
16.12	Functional description of ventilator system	342
16.13	Symbols used on device labels and packaging	346
16.14	Standards and approvals	348
16.15	Disposal and year of manufacture	349
16.16	Warranty.....	350

16.1 Physical characteristics

Table 16-1. Physical characteristics

Dimension	Specifications
Weight	Monitor without shelf mount: 7.8 kg
	Monitor (interaction panel) with shelf mount: 10.0 kg (22.0 lb)
	Ventilation unit with shelf mount: 10.5 kg (23.15 lb)
	46 kg (101 lb) with trolley, monitor, and ventilation unit The trolley can accommodate a maximum safe working load of 80 kg (176 lb). ⁸⁰
Dimensions	See the following figures.

Figure 16-1. HAMILTON-C6 dimensions

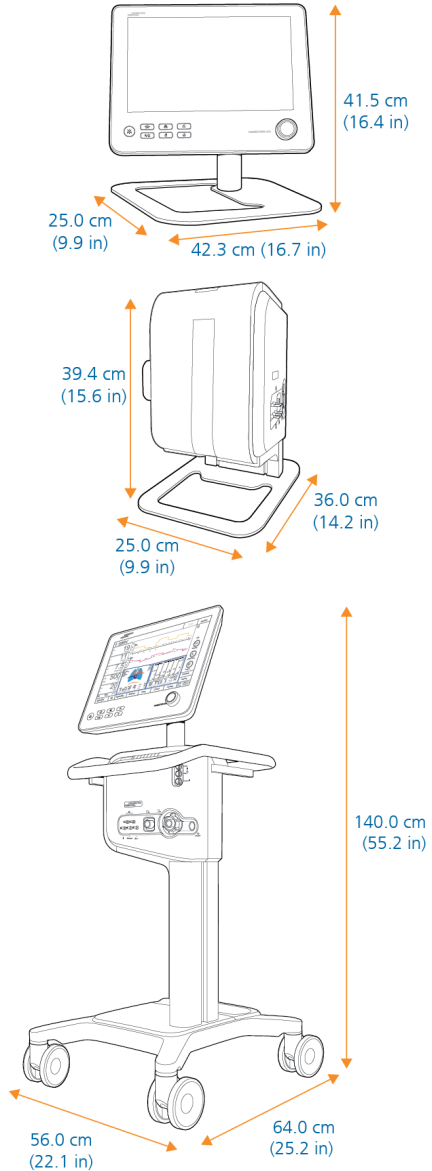

⁸⁰ The maximum safe working load applies to a stationary, properly load-balanced trolley.

Figure 16-2. HAMILTON-C6, combined shelf mount dimensions

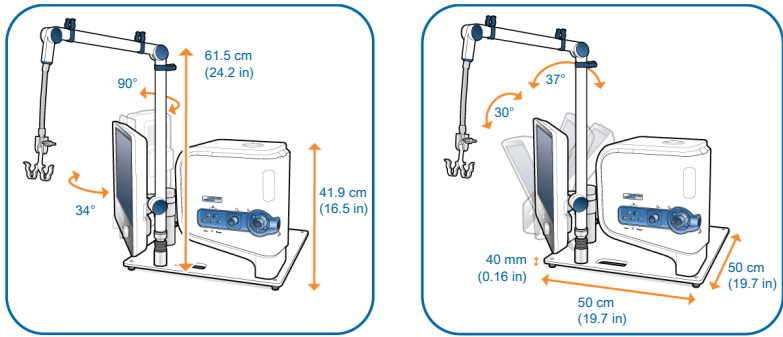
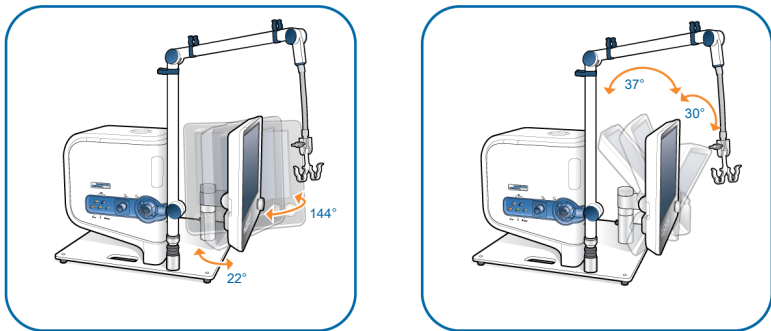

Figure 16-3. HAMILTON-C6, combined shelf mount, swivel and tilt ranges



16.2 Environmental requirements

Table 16-2. Environmental requirements

Environment		Specifications
Temperature	Operation: ⁸¹	5°C to 40°C (41°F to 104°F)
	Shipment/storage:	-20°C to 60°C (-4°F to 140°F), in original packaging
Altitude		-650 to 4000 m (-2,132 to 13,123 ft) Note that at higher altitudes the ventilator performance may be limited. The Performance limited by high altitude alarm is generated and a message is shown on the display. See Table 9-2.
Atmospheric pressure	Operation ⁸¹ , shipment, and storage:	620 to 1100 hPa
Relative humidity	Operation ⁸¹ , shipment, and storage:	10% to 95%, noncondensing
Water protection		IP22
For specifications related to any external devices and sensors, refer to the manufacturer's <i>Instructions for Use</i> .		
For specifications related to the mainstream and sidestream CO2 sensor, see Section 16.11.		

⁸¹ The stated operating conditions apply to operation of the ventilator within the limitations specified in the Intended use.

16.3 Pneumatic specifications

Table 16-3. Pneumatic specifications

Component	Specifications	
High-pressure oxygen inlet ⁸²	Pressure:	2.8 to 6 bar / 41 to 87 psi
	Flow:	Maximum of 200 l/min
	Connector:	DISS (CGA 1240) or NIST
Air supply	Integrated blower	
Gas mixing system	Delivered flow:	<ul style="list-style-type: none"> > 260 l/min \pm10% against ambient pressure (at sea level) Maximum 150 l/min with 100% oxygen
	Delivered pressure:	0 to 100 cmH ₂ O
	Flow accuracy:	\pm 10% or \pm 300 ml/min (whichever is greater)
Inspiratory outlet (To patient port)	Connector:	ISO ID15/OD22 conical
Expiratory outlet (From patient port)	Connector (on expiratory valve):	ISO ID15/OD22 conical
IntelliCuff port	Dedicated connection port for IntelliCuff. For details, see the <i>IntelliCuff Instructions for use</i> .	

⁸² Measurement expressed in STPD (standard temperature and pressure, dry).

16.4 Electrical specifications

Table 16-4. Electrical specifications

Element	Specifications
Input power	100 to 240 VAC, 50/60 Hz
Power consumption	60 VA typical, 210 VA (510 VA with humidifier) maximum
HAMILTON-H900 power connection	The power socket on the HAMILTON-C6 ventilator body is for the HAMILTON-H900 humidifier only.
Battery	Hamilton Medical provides a high-capacity battery. An optional second battery is available.
Electrical specifications:	14.4 V, 5.0 Ah, 72 Wh
Type:	Lithium-ion, supplied by Hamilton Medical only
Recharge time:	Allow a minimum of 2.5 hours to fully charge one battery, or 5 hours to fully charge two batteries. At temperatures over 43°C, the charge time is doubled (a minimum of 5 hours to charge one battery, 10 hours to charge two).
Storage:	-20°C to 50°C, ≤ 95% relative humidity. The storage location should be free from vibration, dust, direct sunlight, moisture, and corrosive gases, and with a recommended temperature range < 21°C. Extended exposure to temperatures above 45°C can degrade battery performance and life.

Element	Specifications
Battery	<p data-bbox="331 204 1020 256">Maximum operating time: Typically 1.5 hours with one battery, 3 hours with two batteries</p> <p data-bbox="516 268 1020 437">Operating time is measured with one fully charged battery, the blower in use, without communication board, and with the following settings: Mode = PCV+, Rate = 10 b/min, $\Delta P_{\text{control}} = 10 \text{ cmH}_2\text{O}$, I:E = 1:4, PEEP = 5 cmH₂O, Flow trigger = 5 l/min, Oxygen = 40%, backlight = 10%.</p> <p data-bbox="516 448 1020 646">This operating time applies to new, fully charged Li-ion batteries that have not been exposed to extreme temperatures. The actual operating time depends on battery age and on how the battery is used and recharged. To ensure maximum battery life, maintain a full charge and minimize the number of complete discharges.</p>

16.5 Control settings

Table 16-5. Control settings, ranges, and accuracy

Parameter or setting (unit)	Range:	Range:	Default:	Default:	Accuracy ⁸³
	Adult/Ped	Neonatal	Adult/Ped	Neonatal	
%MinVol ⁸⁴ (%)	25 to 350	--	100	--	--
Δ Pcontrol ⁸⁵ (cmH ₂ O)	5 to 100	3 to 60	15	15	$\pm 5\%$ or ± 1 cmH ₂ O, whichever is greater
Δ Pinsp ⁸⁶ (cmH ₂ O)	3 to 100	3 to 60 nCPAP-PS: 0 to 60	15	15	$\pm 5\%$ or ± 1 cmH ₂ O, whichever is greater
Δ Psupport ⁸⁷ (cmH ₂ O)	0 to 100	0 to 60	15	15	$\pm 5\%$ or ± 1 cmH ₂ O, whichever is greater
Apnea back-up	On, Off	On, Off	On	On	--
Cuff pressure (cmH ₂ O)	0 to 50	0 to 50	IntelliCuff default	IntelliCuff default	--
End PEEP (cmH ₂ O)	0 to 35	0 to 35	startup setting = PEEP	startup setting = PEEP	--
ETS ^{88, 89} (%)	5 to 80	5 to 80	25	25	--

⁸³ The stated accuracy includes the tolerance interval for each measurement.

⁸⁴ Only in ASV mode.

⁸⁵ Control pressure, added to PEEP/CPAP.

⁸⁶ Inspiratory pressure, added to PEEP/CPAP.

⁸⁷ Pressure support, added to PEEP/CPAP.

⁸⁸ Expiratory trigger sensitivity, in % of inspiratory peak flow.

⁸⁹ When selecting a noninvasive mode, the device uses the ETS value used in the previous mode, if available. If the previous mode did not use ETS, the device sets ETS to default values.

Parameter or setting (unit)	Range:	Range:	Default:	Default:	Accuracy ⁸³
	Adult/Ped	Neonatal	Adult/Ped	Neonatal	
Exp. temperature increase	On, Off	On, Off	Off	Off	--
Flow Pattern ⁹⁰	Square, 50% decelerating, Sine, 100% decelerating	--	50% decelerating	--	--
Flow ⁹¹ (l/min)	2 to 100	2 to 30	15	2	±10% or ±1 l/min, whichever is greater
I:E ⁹²	1:9 to 4:1	1:9 to 4:1	1:4	1:3	--
IBW ⁹³ (kg)	3 to 139	--	70	--	--
Nebulizer duration (min)	5 to 40	5 to 40	30	30	--
Nebulizer synchronization	Inspiration, Exhalation, Insp. & Exh.	Inspiration, Exhalation, Insp. & Exh.	Inspiration	Inspiration	--
Oxygen (%)	21 to 100	21 to 100	50	50	± (volume fraction of 2.5% + 2.5% gas level)
P high (cmH ₂ O) in APRV	0 to 100	0 to 60	20 startup setting = PEEP + 15	20 startup setting = PEEP + 15	±5% or ±1 cmH ₂ O, whichever is greater

⁹⁰ Parameter depends on selected ventilation timing philosophy, set in Configuration.

⁹¹ Only for HiFlowO₂ therapy.

⁹² In PCV+, (S)CMV, SIMV, and APVcmv modes, mandatory breath timing can be controlled by using a combination of inspiratory time (TI) and Rate, or by the I:E ratio; set the method in Configuration. All other modes are controlled by using a combination of inspiratory time (TI) and Rate.

⁹³ IBW is calculated using height and sex, and is used for adult and pediatric patients. Actual body weight is used for neonates.

Parameter or setting (unit)	Range:	Range:	Default:	Default:	Accuracy ⁸³
	Adult/Ped	Neonatal	Adult/Ped	Neonatal	
P high (cmH2O) <i>in DuoPAP</i>	0 to 100	0 to 60	20	20	±5% or ±1 cmH2O , whichever is greater
P low (cmH2O) <i>in APRV</i>	0 to 50	0 to 25	5	5	±5% or ±1 cmH2O , whichever is greater
Pat. height (cm) (in)	30 to 250 12 to 98	-- --	174 69	-- --	-- --
Pause ⁹⁴ (%)	0 to 70	--	0	--	--
Peak flow ⁹⁵ (l/min)	1 to 195	--	60	--	--
PEEP/CPAP (cmH2O)	0 to 50	0 to 25	5	5	±5% or ±1 cmH2O , whichever is greater
Plimit (cmH2O)	5 to 100	5 to 60	30	30	±5% or ±1 cmH2O , whichever is greater
P-ramp ⁹⁶ (ms)	0 to 2000 ASV, NIV, NIV-ST, SPONT, SIMV: max = 200	0 to 600 NIV, NIV-ST, SPONT, nCPAP-PS: max = 200	70	50	±10 ms
Pstart (cmH2O)	0 to 35	0 to 35	startup setting = PEEP	startup setting = PEEP	--

⁹⁴ Limited to 25% of TI.

⁹⁵ Limitation changes based on flow pattern and Vt.

⁹⁶ P-ramp is limited to one-third (1/3) of TI time. Adjustment of TI time can override the P-ramp setting.

Parameter or setting (unit)	Range:	Range:	Default:	Default:	Accuracy ⁸³
	Adult/Ped	Neonatal	Adult/Ped	Neonatal	
Ptop (cmH ₂ O)	25 to 60	25 to 60	35	35	--
Ramp speed (cmH ₂ O/s)	2 to 5	2 to 5	3	3	--
Rate ⁹⁷ (b/min)	1 to 80 APVcmv, PCV+, (S)CMV: 4 to 80 PSIMV+, NIV-ST: 5 to 80	1 to 150 PSIMV+, nCPAP-PS: 5 to 150 APVcmv, PCV+, PSIMV+Psync, NIV-ST, Apnea Backup: 10 to 150	35 (3.0 to 5.9 IBW) 30 (6.0 to 8.9 IBW) 25 (9.0 to 19.9 IBW) 20 (20 to 30 IBW) 17 (31 to 39 IBW) 15 (40 to 59 IBW) 12 (60 to 139 IBW)	60 (0.2 to 1.25 kg) 45 (1.26 to 2.99 kg) 35 (3.0 to 5.9 kg) 30 (6.0 to 8.9 kg) 25 (9.0 to 19.9 kg) 20 (20 to 30 kg)	±1
Set temp ⁹⁸ (°C)	INV: 35 to 41 NIV: 30 to 35 HiFlowO2: 33 to 37	INV: 35 to 41 NIV: 30 to 35 HiFlowO2: 33 to 37	INV: 37 NIV: 31 HiFlowO2: 35	INV: 37 NIV: 31 HiFlowO2: 35	INV: 0.5 NIV: 0.5 HiFlowO2: 2
Sex	Male, Female	--	Male	--	--
Sigh ⁹⁹	On, Off	--	Off	--	--
T gradient ¹⁰⁰ (°C)	-2 to 3	-2 to 3	2	3	0.5
T high ⁹⁷ (s) <i>in DuoPAP and APRV</i>	0.1 to 40	0.1 to 40	Based on rate (IBW)	Based on rate (Weight)	±0.01
T low (s) <i>in APRV</i>	0.2 to 40	0.2 to 40	Based on rate (IBW)	Based on rate (Weight)	±0.01

⁹⁷ Startup setting derived from IBW (adult/pediatric), body weight setting (neonatal). Does not apply in ASV mode.

⁹⁸ When the humidifier is operating in HiFlow, the Set temp control *cannot* be set to a value higher than 39°C. If the control on the ventilator is set above 39°C, the setting is automatically rounded down to 39°C.

⁹⁹ Sigh is disabled in DuoPAP and APRV modes, when using HiFlowO2, and for neonates.

¹⁰⁰ T gradient is always set to 2°C when the humidifier is set to HiFlow.

Parameter or setting (unit)	Range:		Default:		Accuracy ⁸³
	Adult/Ped	Neonatal	Adult/Ped	Neonatal	
Tl max ¹⁰¹ (s)	0.5 to 3	0.25 to 3	1.5	1.0 (≤ 10 kg) 1.5 (> 10 kg)	±0.1
Tl ^{92, 97, 102} (s)	0.1 to 12	0.1 to 12	Based on rate (IBW)	Based on rate (Weight)	±0.01
Tip ¹⁰³ (s)	0 to 8	--	0	--	--
Tpause (s)	0 to 30	0 to 30	0	0	--
TRC Compensation level ¹⁰⁴ (%)	0 to 100	0 to 100	100	100	--
TRC Expiration	On, Off	On, Off	On	On	--
TRC Tube size (mm)	3 to 10	2.5 to 5	7	3.5	--
TRC Tube type	ET tube, Trach tube, Disable TRC	ET tube, Trach tube, Disable TRC	Disable TRC	Disable TRC	--
Trigger, expiratory	ETS, Intelli-Sync+ ¹⁰⁵	ETS	ETS	ETS	--

¹⁰¹ Maximum inspiratory time for spontaneous breaths during noninvasive ventilation.

¹⁰² Inspiratory time; used with Rate to set the breath cycle time.

¹⁰³ Applicable only when the Peak flow - Tip breath timing option is selected.

¹⁰⁴ Set to 0% to have Ptrach displayed without compensation.

¹⁰⁵ Not available in all markets.

¹⁰⁶ Flow trigger is leak compensated.

Parameter or setting (unit)	Range:	Range:	Default:	Default:	Accuracy ⁸³
	Adult/Ped	Neonatal	Adult/Ped	Neonatal	
Trigger, flow ¹⁰⁶ (l/min)	0.5 to 20 APVcmv, (S)CMV, PCV+: 1 to 20 / Off	0.1 to 5 APVcmv, PCV+: 0.1 to 5.0 / Off	5	0.5	±10%
Trigger, inspiratory	Flow trigger, Pressure trigger, IntelliSync+ ¹⁰⁵	Flow trigger, Pressure trigger	Flow trigger	Flow trigger	--
Trigger, pressure (cmH2O)	-0.1 to -15 APVcmv, (S)CMV, PCV+: -0.1 to -15.0 / Off	-0.1 to -15 APVcmv, PCV+: -0.1 to -15.0 / Off	-2	-1	±10%
Vt/IBW ¹⁰⁷ Vt/Weight ¹⁰⁷ (ml/kg)	5 to 12	5 to 12	8	5	--
Vt ⁹⁷ (ml)	20 to 2000	2 to 300	Based on IBW	Based on Weight	Adult/Ped: ±10% or ±10 ml, whichever is greater Neo: ±10% or ±2 ml, whichever is greater
Weight (kg)	--	0.2 to 30	--	2.0	--

¹⁰⁷ Set in configuration. IBW is calculated using height and sex, and is used for adult and pediatric patients. Actual body weight is used for neonates.

16.6 Monitored parameters

Table 16-6 provides monitored parameter details.

Tables 16-7 and 16-8 list the ranges of the real-time curves and loops.

Pressure, flow, and volume measurements are based on readings from the flow sensor, and are expressed in BTPS (body temperature and pressure saturated).

The monitored parameters displayed on the ventilator are rounded to the nearest whole number, when required.

Waveforms displayed on the ventilator are not filtered and represent the actual monitored values.

Table 16-6. Monitored parameters, ranges, and accuracy

Parameter (units)	Range: Adult/Ped	Range: Neonatal	Accuracy ¹⁰⁸
Pressure			
AutoPEEP (cmH2O)	0 to 80	0 to 80	±2 cmH2O + 4% of the actual reading
Driving pressure, ΔP (cmH2O)	0 to 100	0 to 100	±2 cmH2O + 4% of the actual reading
PEEP/CPAP (cmH2O)	0 to 100	0 to 100	±2 cmH2O + 4% of the actual reading
ΔP _{insp} ¹⁰⁹ (cmH2O)	0 to 50	--	±2 cmH2O + 4% of the actual reading
P _{mean} (cmH2O)	0 to 120	0 to 120	±2 cmH2O + 4% of the actual reading
P _{peak} (cmH2O)	0 to 120	0 to 120	±2 cmH2O + 4% of the actual reading
P _{plateau} (cmH2O)	0 to 120	0 to 120	±2 cmH2O + 4% of the actual reading
P _{es max} (cmH2O)	0 to 120	0 to 120	±2 cmH2O + 4% of the actual reading
P _{es plateau} (cmH2O)	0 to 120	0 to 120	±2 cmH2O + 4% of the actual reading
P _{es min} (cmH2O)	-120 to 120	-120 to 120	±2 cmH2O + 4% of the actual reading

¹⁰⁸ The stated accuracy includes the tolerance interval for each measurement, except for measurements displayed from external sensors (CO2). See Section 16.11.1 for details.

¹⁰⁹ Inspiratory pressure displayed in the Vent Status panel.

Parameter (units)	Range: Adult/Ped	Range: Neonatal	Accuracy ¹⁰⁸
Pprox ¹¹⁰	0 to 100	0 to 80	±2 cmH2O + 4% of the actual reading
Ptrans E (cmH2O)	-120 to 120	-120 to 120	±2 cmH2O + 4% of the actual reading
Ptrans I (cmH2O)	-120 to 120	-120 to 120	±2 cmH2O + 4% of the actual reading
Flow			
Insp Flow (peak) (l/min)	0 to 260	0 to 260	Adult/Ped: ±10% or ±20 ml/s, whichever is greater Neo: ±10% or ±20 ml/s, whichever is greater
Exp Flow (peak) ¹¹¹ (l/min)	0 to 260	0 to 260	Adult/Ped: ±10% or ±20 ml/s, whichever is greater Neo: ±10% or ±2 ml/s, whichever is greater
Flow ¹¹⁰ (l/min) <i>in HiFlowO2</i>	2 to 105	2 to 30	--
Volume			
ExpMinVol ¹¹² MinVol NIV ¹¹³ (l/min)	0 to 99.9	0 to 99.9	±10% or ±0.3 l/min, whichever is greater
MVSpont ¹¹² MVSpont NIV ¹¹³ (l/min)	0 to 99.9	0 to 99.9	±10% or ±0.3 l/min, whichever is greater

¹¹⁰ Only in HiFlowO2.¹¹¹ Not available in HiFlowO2.¹¹² Only for invasive modes.¹¹³ NIV is used with noninvasive modes.

Parameter (units)	Range: Adult/Ped	Range: Neonatal	Accuracy ¹⁰⁸
VTE ¹¹² VTE NIV ¹¹³ (ml)	0 to 9000	0 to 9000	Adult/Ped: ±10% or ±10 ml, whichever is greater Neo: ±10% or ±2 ml, whichever is greater
VTEspont (ml)	0 to 9000	0 to 9000	±10% or ±10 ml, whichever is greater
VTI (ml)	0 to 9000	0 to 9000	Adult/Ped: ±10% or ±10 ml, whichever is greater Neo: ±10% or ±2 ml, whichever is greater
Vt/IBW (ml/kg)	2 to 20	--	--
Vt/Weight (ml/kg)	--	2 to 20	--
VLeak (%)	0 to 100	0 to 100	±10% (VLeak > 100 ml and < 2000 ml)
MVLeak (l/min)	0 to 99.9	0 to 99.9	±10% or ±0.3 l/min whichever is greater
Time			
I:E	9.9:1 to 1:99	9.9:1 to 1:99	--
fControl (b/min)	0 to 999	0 to 999	±1 b/min
fSpont (b/min)	0 to 999	0 to 999	±1 b/min
fTotal (b/min)	0 to 999	0 to 999	±1 b/min

Parameter (units)	Range: Adult/Ped	Range: Neonatal	Accuracy ^{10B}
TI (s)	0 to 60	0 to 60	±100 ms
TE (s)	0 to 60	0 to 60	±100 ms
Pause (s)	0 to 60	0 to 60	--

Other calculated and displayed parameters

Cstat (ml/cmH2O)	0 to 300	0 to 300	--
Oxygen (%)	18 to 105	18 to 105	± (volume fraction of 2.5% + 2.5% gas level)
P0.1 (cmH2O)	-99 to 0	-99 to 0	--
Pes P0.1 (cmH2O)	-99 to 0	-99 to 0	--
PTP (cmH2O*s)	0 to 99	0 to 99	--
Pes PTP (cmH2O*s)	0 to 99	0 to 99	--
RCexp ¹¹⁴ (s)	0 to 99.9	0 to 99.9	--
Rinsp (cmH2O / (l/s))	0 to 999	0 to 999	--
RSB (1 / (l*min))	0 to 400	0 to 400	--
Ventilation counter (days/hours/minutes)	0 to 999	0 to 999	--

¹¹⁴ Least square fit method.

¹¹⁵ Only available if the CO2 communication board is installed and the CO2 sensor is enabled.

Parameter (units)	Range: Adult/Ped	Range: Neonatal	Accuracy ¹⁰⁸
CO2 related¹¹⁵			
FetCO2 (%)	0 to 20	0 to 20	CO2 (BTPS): 0 to 40 mmHg: ±2 mmHg
PetCO2 (mmHg)	0 to 150	0 to 150	41 to 70 mmHg: ±5% of reading 71 to 100 mmHg: ±8% of reading 101 to 150 mmHg: ±10% of reading For sidestream CO2 sensor above 80 b/min: ±12% of reading
slopeCO2 ¹¹⁶ (%CO2/l)	0 to 99.9	0 to 99.9	--
Vtalv ¹¹⁶ (ml)	0 to 9999	0 to 9999	--
V'alv ¹¹⁶ (l/min)	0 to 20	0 to 20	--
V'CO2 ¹¹⁶ (ml/min)	50 to 9999	50 to 9999	--
VDaw ¹¹⁶ (ml)	0 to 999	0 to 999	--
VDaw/VTE ¹¹⁶ (%)	0 to 100	0 to 100	--
VeCO2 ¹¹⁶ (ml)	0 to 999	0 to 999	--
ViCO2 (ml)	0 to 999	0 to 999	--

¹¹⁶ Only for mainstream CO2.

Parameter (units)	Range: Adult/Ped	Range: Neonatal	Accuracy ¹⁰⁸
P/V Tool Pro related			
Pressure at cursors (cmH ₂ O)	0 to 99	0 to 99	--
Volume at cursors (ml)	0 to 9999	0 to 9999	--
Volume difference at cursors (ml)	0 to 9999	0 to 9999	--
Flow at cursors (l/min)	-300 to 300	-300 to 300	--
Compliance at cursors (ml/cmH ₂ O)	0 to 999	0 to 999	--
P _{top} (cmH ₂ O)	0 to 99	0 to 99	--
T _{maneuver} (s)	0 to 99	0 to 99	--
Lower inflection point (cmH ₂ O)	0 to 99	0 to 99	--
Upper inflection point (cmH ₂ O)	0 to 99	0 to 99	--
Point of derecruitment (cmH ₂ O)	0 to 99	0 to 99	--
V _{peep} (ml)	0 to 9999	0 to 9999	--
Humidifier related			
T humidifier ¹¹⁷ (°C)	0 to 99.9	0 to 99.9	--
T Y-piece ¹¹⁷ (°C)	0 to 99.9	0 to 99.9	--
IntelliCuff related			
P _{cuff} (cmH ₂ O)	-100 to 150	-100 to 150	--

¹¹⁷ Activated upon connection of a HAMILTON-H900 humidifier.

Table 16-7. Real-time waveforms

Parameter	Range	Y-axis scale
<i>All waveforms show time, in seconds, on the x-axis.</i>		
<i>Full-screen waveforms: 11, 22, 33, 66; Half-screen waveforms: 5.5, 11, 22, 33</i>		
Volume ¹¹⁸ (V) (ml) / time (s)	0 to 3200	0 to 5, 0 to 10, 0 to 25, 0 to 50 (Neonatal default), 0 to 100, 0 to 200, 0 to 400, 0 to 800 (Adult/Ped default), 0 to 1600, 0 to 3200
Flow ¹¹⁸ (l/min) / time (s)	-300 to 300	±2.5, ±5, ±10 (Neonatal default), ±15, ±25, ±45, ±75 (Adult/Ped default), ±150, ±300
Airway pressure (Paw) (cmH2O) / time (s)	-10 to 120	-5 to 20, -5 to 40 (default), -5 to 80, -5 to 120
FCO ₂ ¹¹⁹ (%) / time (s)	0 to 20	0 to 6 (default), 0 to 10
PCO ₂ ¹¹⁹ (mmHg) / time (s)	0 to 150	0 to 60 (default), 0 to 100
P _{trach} ¹²⁰ (cmH2O) / time (s)	-120 to 120	-5 to 20, -5 to 40, -5 to 80, -5 to 120
Real-time Pes (cmH2O)	-30 to 120	-5 to 20, -5 to 40 (default), -5 to 80, -5 to 120, -20 to 20, -20 to 40 (default), -20 to 80, -20 to 120, -40 to 20, -40 to 40 (default), -40 to 80, -40 to 120, -80 to 20, -80 to 40 (default), -80 to 80, -80 to 120, -120 to 20, -120 to 40 (default), -120 to 80, -120 to 120
Real-time P _{transpulm} (cmH2O)	-120 to 120	-5 to 20, -5 to 40 (default), -5 to 80, -5 to 120, -20 to 20, -20 to 40 (default), -20 to 80, -20 to 120, -40 to 20, -40 to 40 (default), -40 to 80, -40 to 120, -80 to 20, -80 to 40 (default), -80 to 80, -80 to 120, -120 to 20, -120 to 40 (default), -120 to 80, -120 to 120

¹¹⁸ Scaled automatically. Not leak compensated.

¹¹⁹ Available with CO₂ option.

¹²⁰ Scaled automatically. Shown together with the pressure/time waveform in the same window (different color waveform). Only active when TRC is enabled.

Table 16-8. Real-time graphics and loops

Parameter	X-axis scale	Y-axis scale
ASV graphs		
ASV target graphics: Vt/Rate x-axis: b/min y-axis: ml	0 to 60	0 to 5, 0 to 10, 0 to 25, 0 to 50, 0 to 100, 0 to 200, 0 to 400, 0 to 800 (<i>default</i>), 0 to 1600, 0 to 3200
Loops		
Pressure/Volume x-axis: cmH2O y-axis: ml	-10 to 120	0 to 3200
Volume/Flow x-axis: ml y-axis: l/min	0 to 3200	-300 to 300
Pressure/Flow x-axis: cmH2O y-axis: l/min	-10 to 120	-300 to 300
Volume/PCO2 ¹²¹ x-axis: ml y-axis: mmHg	0 to 3200	0 to 100
Volume/FCO2 ¹²¹ x-axis: ml y-axis: %	0 to 3200	0 to 10
Pes/Volume x-axis: cmH2O y-axis: ml	-30 to 120	0 to 3200
Ptranspulm/Volume x-axis: cmH2O y-axis: ml	-120 to 120	0 to 3200

¹²¹ Available with CO2 option.

16.7 Alarms

Table 16-9. Adjustable alarm priority, range, defaults, and resolution

Alarm (units)	Priority	Range:	Range:	Default:	Default:	Resolution
		Adult/Ped	Neo	Adult/ Ped	Neo	
Apnea time (s)	High	15 to 60	5 to 60 nCPAP-PS: 5 to 60 / Off	20	5	<i>Adult/Ped:</i> 5 <i>Neonatal:</i> 1 (< 15) 5 (≥ 15)
ExpMinVol (high) ¹²² (l/min)	High	0.1 to 50 NIV, NIV-ST: 0.1 to 50 / Off	0.03 to 10 / Off	Based on Rate and Vt 1.5 * Rate * Vt	Based on Rate and Vt 1.5 * Rate * Vt	<i>Adult/Ped:</i> 0.1 (< 1) 0.5 (≥ 1) 1 (≥ 10) <i>Neonatal:</i> 0.01 (< 1) 0.1 (≥ 1)
ExpMinVol (low) ¹²² (l/min)	High	0.1 to 50 NIV, NIV-ST: Off / 0.1 to 50	Off / 0.01 to 10	Based on Rate and Vt 0.6 * Rate * Vt	Based on Rate and Vt 0.6 * Rate * Vt	<i>Adult/Ped:</i> 0.1 (< 1) 0.5 (≥ 1) 2 (≥ 10) <i>Neonatal:</i> 0.01 (< 1) 0.1 (≥ 1)
fTotal (high) (b/min)	Medium	0 to 99	2 to 210	40	70	1
fTotal (low) (b/min)	Medium	0 to 99	0 to 200	0	0	1

¹²² Startup setting derived from IBW (adult/pediatric), body weight setting (neonatal). Does not apply in ASV mode.

¹²³ Active only when O2 monitoring is enabled.

¹²⁴ The high and low oxygen alarm limits are automatically set in relation to the current oxygen setting: O2 setting + 5 (high Oxygen limit) and O2 setting - 5 (low Oxygen limit). For example, if the Oxygen setting is 70%, the high Oxygen limit is set to 75 and the low limit is set to 65.

Alarm (units)	Priority	Range:	Range:	Default:	Default:	Resolution
		Adult/Ped	Neo	Adult/Ped	Neo	
Oxygen (high) ^{123,124} (%)	High	18 to 105	18 to 105	55 or +5% of the current setting	55 or +5% of the current setting	1
Oxygen (low) ^{123,124} (%)	High	18 to 97	18 to 97	45 or -5% of the current setting	45 or -5% of the current setting	1
PetCO ₂ (high) ¹²⁵ (mmHg)	Medium	11 to 100	1 to 100	60	60	1
PetCO ₂ (low) ¹²⁵ (mmHg)	Medium	Off / 10 to 99	Off / 10 to 99	30	30	1
Pressure (high) (Pmax) ¹²⁶ (cmH ₂ O)	High	15 to 110	15 to 110	40	40	1
Pressure (low) (cmH ₂ O)	High	4 to 100	4 to 60 nCPAP-PS: 2 to 60	PEEP	PEEP nCPAP-PS: 5	1
Pressure limitation (cmH ₂ O)	Medium, Low after silence	5 to 100	5 to 100	Pmax -10	Pmax -10	1

¹²⁵ CO₂ option required.

¹²⁶ Can also be adjusted using Plimit. Pressure limitation is always 10 cmH₂O below the pressure high limit.

¹²⁷ In ASV mode, this alarm only applies for spontaneous breaths.

Alarm (units)	Priority	Range:	Range:	Default:	Default:	Resolution
		Adult/Ped	Neo	Adult/Ped	Neo	
Vt (high) ¹²⁷ (ml)	Medium	10 to 3000 / Off	0.1 to 300 / Off	Vt is based on IBW 1.5 * Vt	Vt is based on Weight 1.5 * Vt	<i>Adult/Ped:</i> 5 (< 100) 10 (< 500) 50 (≥ 500) <i>Neonatal:</i> 0.1 (< 10) 1 (≥ 10) 5 (≥ 100)
Vt (low) ¹²⁷ (ml)	Medium	Off / 10 to 3000	Off / 0.1 to 300	Vt is based on IBW 0.5 * Vt	Vt is based on Weight 0.5 * Vt	<i>Adult/Ped:</i> 5 (< 100) 10 (< 500) 50 (≥ 500) <i>Neonatal:</i> 0.1 (< 10) 2 (≥ 10) 6 (≥ 100)

16.8 Configuration

Table 16-10. Configuration specifications

Parameter	Configuration range	Default setting
General		
Language	English, US English, Chinese, Croatian, Czech, Danish, Dutch, Finnish, French, German, Greek, Hungarian, Indonesian, Italian, Japanese, Korean, Norwegian, Polish, Portuguese, Romanian, Russian, Serbian, Slovak, Spanish, Swedish, Turkish, Ukrainian	English
Units	Pressure: hPa, mbar, cmH2O CO2: mmHg, Torr, kPa Length: cm, in	cmH2O mmHg cm
More	Communication protocol: Hamilton, GALILEO compatible, Hamilton P2, Philips Vuelink Open, DrägerTestProtocol, Hamilton Block, Hamilton Block (ACK), HAMILTON-H900	COM1: GALILEO compatible COM2: GALILEO compatible COM3: HAMILTON-H900
	Min. loudness	1
	FS alarm sensitivity: 5 to 15%, Off	12%
	HiFlowO2 limitation ¹²⁸ : 2 to 30 l/min	15 l/min
Modes		
Philosophy	Inspiratory time philosophy: I:E/Pause, TI/Pause, Peak flow/Tip	I:E/Pause
	Mode label: APVcmv/APVsimv or (S)CMV+/SIMV+	APVcmv/APVsimv
	ASV: ASV, ASV 1.1	ASV 1.1
	Ti max available in invasive modes	Disabled

¹²⁸ Only applies to the Neonatal patient group.

Parameter	Configuration range	Default setting
Graphics		
Main monitoring parameters (MMP) ¹²⁹	MMP 1 to 5: Pmean, PEEP/CPAP, Ppeak, ExpMinVol, VTI, VTE, VLeak, fTotal, fSpont, Oxygen, Cstat, Rinsp, Driving pressure, I:E, TI, TE, MVSpont, AutoPEEP, P0.1, PTP, RCexp, Pplateau, VTESpont, MVLeak, Insp Flow, Exp Flow, Vt/IBW, Vt/Weight, Pcuff (IntelliCuff), T humidifier and T y-piece (HAMILTON-H900), PEEP (Pes), Ppeak (Pes), Pplateau (Pes), Pmin (Pes), P0.1 (Pes), PTP (Pes), Ptrans I (Pes), Ptrans E (Pes)	Ppeak ¹³⁰ , ExpMinVol, VTE, fTotal, I:E
Settings	For all mode, control, and alarm settings, see the appropriate tables in this chapter.	
Setups	This information applies to the default adult Quick setup configurations. You can also specify default neonatal settings.	
Mode Ctrls	Vt/IBW (Adult/Ped): 5 to 12 ml/kg Vt/Weight (Neonatal): 5 to 12 ml/kg	Adult/Ped: 8 ml/kg Neonatal: 5 ml/kg
Vent Status		
Oxygen ¹³¹ (%)	22 to 80	40
PEEP ¹³² (cmH2O)	1 to 20	8
ΔPinsp (cmH2O)	1 to 50	10
%MinVol high (%)	100 to 250	150
%MinVol low (%)	25 to 99	50

¹²⁹ Additional parameters available when the CO2 or SpO2 options are installed.

¹³⁰ The default setting is configurable. However, Ppeak is always set as an MMP.

¹³¹ The low Oxygen setting is always 21%.

¹³² The low PEEP setting is always 0 cmH2O.

Parameter	Configuration range	Default setting
RSB high (1 / (l*min))	50 to 150	100
RSB low (1 / (l*min))	0 to 49	10
%fSpont ¹³³ (%)	0 to 99	75

¹³³ The high %fSpont setting is always 100%.

16.9 ASV technical data

Table 16-11. ASV technical data

ASV-related data	Specifications
ASV-related operator settings	
%MinVol	25% to 350%
Patient height	Adults: 130 to 250 cm / 50 to 100 in Pediatric: 30 to 150 cm / 12 to 60 in
Internal calculations	
IBW	In kg, calculated based on patient height and sex (see Section 5.3)
MinVol (target)	In l/min, target minute volume is calculated as: $IBW \text{ (in kg)} \times \text{NormMinVent (in l/kg/min)} \times \%MinVol/100$ where NormMinVent is the normal minute ventilation from Figure 7-19.
fTotal	In b/min
VDaw	2.2 ml/kg IBW
Vt (target)	MinVol / f(target)
ASV monitor	
Target values (numerical)	MinVol, Vt, fTotal
Current achieved values (numerical)	MinVol, Vt, fTotal, $Vt = (VTI+VTE)/2$
Status of patient (numerical)	fSpont, fControl, ΔP_{ins}
Graphics display (curve)	fTotal versus Vt, target value, current value, safety boundaries
Alarms	
All alarms are functional except apnea alarms	See Chapter 9
Special	ASV: Cannot meet target alarm
Performance specifications	
Response time (90% of steady state)	< 1 min (typical)
Overshoot/undershoot	< 25%
Maximum pressure change per breath	3 cmH2O

ASV-related data	Specifications
Settling time	< 120 seconds
Steady state deviation	< 10%
Lung-protective rules	
Minimum Vt	4.4 ml/kg x IBW
Maximum Vt depends on	<ul style="list-style-type: none"> • High Pressure alarm limit • Volume/ pressure ratio (V/P) • Always < 15 ml/kg x IBW¹³⁴ • Limited to 1.5 x high Vt limit
Maximum machine rate	<p>The maximum rate in ASV is the smallest value of the following conditions:</p> <ul style="list-style-type: none"> • 60 b/min • 23 b/min * %MinVol/100 / (IBW = 30 kg) • 23 b/min * %MinVol/ (0.5 to 100 depending on IBW) (IBW < 30 kg) • 20/RCexp
Minimum target rate	5 to 15 b/min (depending on IBW)
Minimum ΔP_{insp}	5 cmH ₂ O above PEEP/CPAP
Maximum ΔP_{insp}	High Pressure alarm limit - 10 cmH ₂ O - PEEP
Minimum inspiratory time (TI)	0.5 s or RCexp, whichever is longer
Maximum inspiratory time (TI)	IBW = 30 kg: 2 seconds IBW < 30 kg: 1.5 seconds
Minimum expiratory time (Te)	0.5 s or 2 x RCexp, whichever is longer
Maximum expiratory time (Te)	12 seconds
I:E range	1:4 to 1:1

¹³⁴ Only applicable to ASV 1.1.

16.10 Ventilator breathing system specifications

Table 16-12. Ventilator breathing system specifications

Parameter	Specification	
Resistance ¹³⁵	Adult circuit (ID22, flow of 30 l/min)	Inspiratory limb: < 0.06 cmH2O/l/min Expiratory limb: < 0.06 cmH2O/l/min
	Pediatric circuit (ID15, flow of 15 l/min)	Inspiratory limb: < 0.12 cmH2O/l/min Expiratory limb: < 0.12 cmH2O/l/min
	Coaxial circuit (ID15, flow of 30 l/min)	Inspiratory limb: < 0.06 cmH2O/l/min Expiratory limb: < 0.06 cmH2O/l/min
	Neonatal circuit (ID12, flow of 2.5 l/min)	Inspiratory limb: < 0.74 cmH2O/l/min Expiratory limb: < 0.74 cmH2O/l/min
Compliance ¹³⁵	Adult circuit (ID22)	~ 2 ml/cmH2O
	Pediatric circuit (ID15)	~ 1.5 ml/cmH2O
	Coaxial circuit (ID15)	~ 2.5 ml/cmH2O
	Neonatal circuit (ID12)	~ 0.8 ml/cmH2O
Volume ¹³⁵	Adult circuit (ID22)	~127 ml
	Pediatric circuit (ID15)	~75 ml
	Coaxial circuit (ID15)	~150 ml
	Neonatal circuit (ID12)	~ 45 ml
Bacteria filter	Particle size	Captures particles of 0.3 mm (micron) with > 99.99% efficiency
	Resistance	< 1.3 cmH2O at 20 l/min
Flow sensor dead space	Adult/pediatric	< 9 ml (single use)
		< 11 ml (reusable)
	Neonatal	< 1.3 ml

¹³⁵ As tested, the inspiratory limb includes ambient valve, flow sensor, inspiratory filter, inspiratory tubes, and humidifier. It does not include the heating wire. The expiratory limb includes expiratory tubes, water trap, expiratory valve, and flow sensor.

16.11 Technical performance data

Table 16-13. Technical performance data

Description	Specification
Patient ideal body weight (IBW, determined from Pat. height setting)	3 to 139 kg (6.6 to 306 lb) ¹³⁶
Weight (used for neonatal patients)	0.2 to 30 kg (0.44 to 66 lb)
Inspiratory pressure	0 to 100 cmH ₂ O
Maximum limited pressure	110 cmH ₂ O
Maximum working pressure	115 cmH ₂ O (total inspiratory pressure). Ensured through pressure limiting
Maximum inspiratory flow	260 l/min
Tidal volume/target tidal volume	Adult/Ped: 20 to 2000 ml Neonatal: 2 to 300 ml
Minute volume capability	Up to 60 l/min
Inspiratory time (spontaneous breaths)	0.25 to 3 seconds
Minimum expiratory time	20% of cycle time; 0.2 to 0.8 seconds
Automatic expiratory base flow	Fixed at 6 l/min
Means of inspiratory triggering	Flow trigger control, pressure trigger control, or optional IntelliSync+ control
Oxygen mixer accuracy	± (volume fraction of 2.5% + 2.5% of actual reading)
O ₂ input flow	80 l/min (at 2.8 bar / 280 kPa / 41 psi input pressure)

¹³⁶ Actual patient weight can be much greater (e.g., 300 kg or 661 lb).

Description	Specification	
Measuring devices		
Continuous oxygen measurement	The delivered oxygen concentration is continuously measured when an O2 sensor is enabled.	
	<i>Type of sensor: Galvanic lead-free O2 sensor</i>	
	Sensing position:	Inspiratory pneumatics
	Measurement, delivered oxygen concentration, range:	18% to 105%
	Response time:	< 45 seconds to reach 90% of final oxygen concentration
	Initialization time (time from turning on device to operating performance):	< 40 seconds
	Drift:	< 1.5% at 60% Oxygen over 6 hours
	Storage temperature:	To maximize the shelf life of unused galvanic O2 sensors, store them between -20°C and 50°C (-4°F and 122°F).
Continuous oxygen measurement	<i>Type of sensor: Galvanic O2 sensor</i>	
	Sensing position:	Inspiratory pneumatics
	Measurement, delivered oxygen concentration, range:	18% to 105%
	Response time:	< 45 seconds to reach 90% of final oxygen concentration
	Initialization time (time from turning on device to operating performance):	< 40 seconds
	Drift:	≤ 2.5% at 60% Oxygen over 6 hours
	Storage temperature:	To maximize the shelf life of unused galvanic O2 sensors, store them between 5°C and 15°C (41°F and 59°F).

Description	Specification		
Continuous oxygen measurement	<i>Type of sensor: Paramagnetic O2 sensor</i>		
	Sensing position:	Inspiratory pneumatics	
	Measurement, delivered oxygen concentration, range:	18% to 105%	
	Response time:	< 45 seconds to reach 90% of final oxygen concentration	
	Initialization time (time from turning on device to operating performance):	< 40 seconds	
	Drift:	≤ 2.5% at 60% Oxygen over 6 hours	
	Storage temperature:	To maximize the shelf life of unused paramagnetic O2 sensors, store them between 5°C and 15°C (41°F and 59°F) in a refrigerator.	
Pressure and volume measurements	Type:	Differential pressure transducer, variable orifice	
	Sensing position:	Patient Y-piece	
	Measurements:	See Table 16-6	

Description	Specification	
CO2 measurement	Two types of CO2 sensors are supported: CAPNOSTAT-5 (mainstream) and LoFlo (sidestream)	
	<i>Type: CAPNOSTAT 5</i>	
	Sensing position:	Mainstream
	Principle of operation:	Nondispersive infrared (NDIR) technology
	Measurements:	See Table 16-6
	Rise time:	< 60 ms
	Initialization time:	Capnogram displayed in < 15 seconds at an ambient temperature of 25°C, full specifications within 2 minutes
	Sampling frequency:	100 Hz
	CO2 calculation method:	BTPS
	CO2 stability ¹³⁷ :	Short-term drift: ≤ 0.8 mmHg over 4 hours Long-term drift: Accuracy specification maintained over 120 hours
	CO2 noise (rms):	≤ 0.25 mmHg at 7.5% CO2
	Operating conditions:	Temperature: 0°C to 45°C (32°F to 113°F) Humidity: 10% to 90% relative humidity, non-condensing Pressure (barometric + airway pressure): 400 mmHg to 850 mmHg
	Storage conditions:	Temperature: -40°C to 70°C (-40°F to 158°F) Humidity: < 90% relative humidity, noncondensing Pressure (atmospheric): 375 mmHg to 795 mmHg

¹³⁷ Neither humidity (noncondensing) nor cyclical pressures have any effect on the stated accuracy of the device.

Description	Specification	
CO2 measurement	<i>Type: LoFlo</i>	
	Sensing position:	Sidestream
	Principle of operation:	Nondispersive infrared (NDIR) technology
	Measurements:	See Table 16-6
	Rise time:	200 ms for on-airway adapter kits Additional 30 ms for sidestream sampling canulas. Additional 80 ms for extension line and dehumidification tubing.
	Initialization time:	Capnogram displayed in < 20 seconds at an ambient temperature of 25°C, full specifications within 2 minutes
	Sampling frequency:	100 Hz
	Gas sampling rate:	50 ml/min ±10 ml/min
	CO2 calculation method:	Actual, corrected for temperature and pressure in the sample cell
	CO2 stability ¹³⁷ :	Short-term drift: ≤ 0.8 mmHg over 4 hours Long-term drift: Accuracy specification maintained over 120 hours
	CO2 noise (rms):	≤ 0.25 mmHg at 5% CO2
	Sensing position:	Inside ventilator
	Measurements:	See Table 16-6
	Operating conditions:	Temperature: 0°C to 40°C (32°F to 104°F) Humidity: 10% to 90% relative humidity, non-condensing Pressure (barometric + airway pressure): 400 mmHg to 800 mmHg
	Storage conditions:	Temperature: -40°C to 70°C (-40°F to 158°F) Humidity: 10% to 90% relative humidity, non-condensing Pressure (atmospheric): 400 mmHg to 800 mmHg

Description	Specification
Tests and special functions	Leak test, flow sensor/O2 sensor/CO2 sensor zero calibration, O2 enrichment, manual breath, inspiratory hold maneuver, nebulization, leak compensation, communication interface, compensation of breathing circuit resistance and compliance, Pes measurement
Display device	Display of settings, alarms, and monitored data: Type: Color TFT Size: 1920 x 1200 pixels, 17 in (431.8 mm) diagonal
Brightness setting for display	The range is 10% to 100% brightness. By default, Day = 80%; Night = 40%.
Alarm volume (Loudness ¹³⁸)	The range is 1 to 10. Adult/Ped: 5 (default) Neonatal: 3 (default)
A-weighted sound power level (L_w) ¹³⁹	45 dB(A) ±3 dB(A)
A-weighted sound pressure level (L_p) ¹³⁹	37 dB(A) ±3 dB(A)

¹³⁸ Volume at 1 meter distance from ventilator. A setting of 1 = 57 dB(A), and 10 = 80 dB(A), with accuracy of ±6 dB(A).

¹³⁹ Per ISO 80601-2-12.

16.11.1 Accuracy testing

The ventilator's parameter and measurement accuracy is tested using an IMT FlowAnalyser. The tolerance intervals for the data generated by the FlowAnalyser are as specified below, and are included in the accuracy information provided in this manual.

Table 16-14. Tolerance intervals for accuracy testing

Parameter type	Tolerance interval of measurement
Volume	≤ 50 ml: $\pm 1\%$ > 50 ml: $\pm 1.75\%$
Pressure	$\pm 0.5\%$ or ± 0.1 cmH ₂ O, whichever is greater
Flow	$\pm 1.75\%$ or ± 0.5 l/min, whichever is greater
O ₂	$\pm 1\%$

16.11.2 Essential performance

Table 16-15. Essential performance

Component	Requirement
Gas supply failure	Gas supply failure must be detected and the operator informed.
Oxygen level alarm condition	If O ₂ is higher or lower than the set alarm limits or the O ₂ sensor fails, this must be detected and the operator informed through an alarm.

Component	Requirement
CO ₂ level alarm condition ¹⁴⁰	If CO ₂ is higher or lower than the set alarm limits or the CO ₂ sensor fails, this must be detected and the operator informed through an alarm.
SpO ₂ level alarm condition ¹⁴⁰	If SpO ₂ is higher or lower than the set alarm limits or the SpO ₂ sensor fails, this must be detected and the operator informed through an alarm.
Pressure	The airway pressure must be monitored. If it is higher or lower than the set alarm limits, this must be detected and the operator informed through an alarm.
Volume	The applied and expired volumes must be monitored. If they are higher or lower than the set alarm limits, this must be detected and the operator informed through an alarm.
Electrical supply failure	An electrical supply failure must be detected and the operator informed.
Internal electrical power source nears depletion	The remaining battery capacity must be monitored and qualitatively indicated. At least 5 minutes prior to depletion, an alarm must be issued.

¹⁴⁰ If option is installed.

16.12 Functional description of ventilator system

The HAMILTON-C6 is an electronically controlled pneumatic ventilation system with an integrated air compressing system. It runs on AC power with battery backup to protect against power failure or unstable power and to facilitate intra-hospital transport.

The user provides inputs to the HAMILTON-C6 microprocessor system through a touch screen, keys, and a press-and-turn knob. These inputs become instructions for the HAMILTON-C6's pneumatics to deliver a precisely controlled gas mixture to the patient. The ventilator receives inputs from the proximal flow sensor and other sensors within the ventilator. Based on this monitored data, the ventilator adjusts gas delivery to the patient. Monitored data is also displayed by the graphical user interface.

The ventilator's microprocessor system controls gas delivery and monitors the patient. The gas delivery and monitoring functions are cross-checked by an alarm controller. This cross-checking helps minimize the possible hazards of software failure.

A comprehensive system of visual and audible alarms helps ensure the patient's safety. Clinical alarms can indicate an abnormal physiological condition. Technical alarms, triggered by the ventilator's self-tests including ongoing background checks, can indicate a hardware or software failure. In the case of some technical alarms, a special safety ventilation ensures basic minute ventilation while giving the operator time for corrective actions.

When a condition is critical enough to possibly compromise safe ventilation, the HAMILTON-C6 is placed into the **Ambient** state. The inspiratory channel and expiratory valves are opened, letting the patient inspire room air through the inspiratory channel and exhale through the expiratory valve.

The HAMILTON-C6 has several means to ensure that safe patient or respiratory pressures are maintained. The maximum working pressure is ensured by the high pressure alarm limit. If the set high pressure limit is reached, the ventilator cycles into exhalation. The ventilator pressure cannot exceed 100 cmH₂O.

16.12.1 Gas supply and delivery

The HAMILTON-C6 uses room air and high-pressure oxygen (Figure 16-4). Air enters through a fresh gas intake port and is compressed together with the oxygen by the blower. Oxygen enters through a high-pressure¹⁴¹ inlet.

Figure 16-4. Gas delivery in the HAMILTON-C6

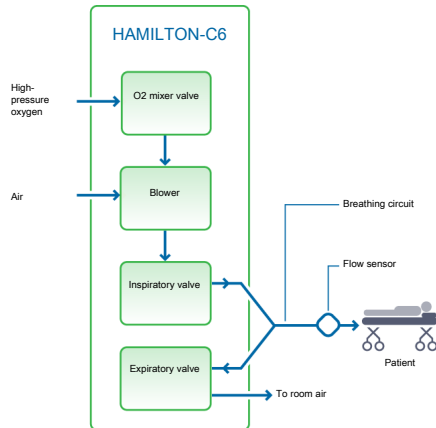

¹⁴¹ High-pressure oxygen: Maximum allowed pressure is 600 kPa.

Within the ventilator, the gas enters the ventilator's pneumatic system. If high-pressure oxygen is supplied, a mixer valve provides for the operator-set concentration.

Gas is supplied to the patient over the inspiratory valve. The microprocessor controls the inspiratory valve opening and the length of time it is open to meet the user settings.

The ventilator delivers gas to the patient through the inspiratory limb breathing circuit parts, which may include one or more of the following: inspiratory filter, flex tubes, humidification system, water traps, Y-piece, and flow sensor. An internal pneumatic nebulizer supplies the nebulizer flow.

Gas exhaled by the patient passes through the expiratory limb breathing circuit parts, which includes one or more of the following: flex tubes, flow sensor, Y-piece, and expiratory valve set. Gas is vented through the expiratory valve housing such that no exhaled gas comes into contact with any internal components of the ventilator. The expiratory valve is heated to reduce the possibility of rainout in the expiratory limb.

Measurements taken at the flow sensor are used in the pressure, flow, and volume measurements.

The ventilator monitors the oxygen concentration of the gas to be delivered to the patient using either a galvanic (included with the ventilator) or paramagnetic O₂ sensor.

The galvanic O₂ sensor generates a voltage proportional to the partial pressure of oxygen in the delivered gas.

The paramagnetic O₂ sensor monitors the oxygen based on the volume magnetic susceptibility of the delivered gas. The paramagnetic O₂ sensor is maintenance free.

The operations of the blower and expiratory valve are coordinated to maintain system pressure levels.

16.12.2 Gas monitoring with the flow sensor

The HAMILTON-C6 accurately measures flow, volume, and pressure in the patient's airway with the Hamilton Medical flow sensor. This proximal flow sensor lets the ventilator sense even weak patient breathing efforts. Between its highly sensitive flow trigger and fast response time, the ventilator helps minimize the patient's work of breathing.

The flow sensor contains a thin membrane within the outer housing and has a pressure port on either side. The membrane allows bidirectional flow through its variable orifice.

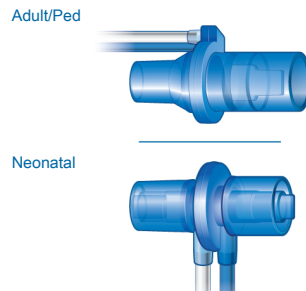

The area of the orifice changes depending on the flow rate. It opens progressively as the flow increases, creating a pressure drop across the orifice. The pressure difference is measured by a high-precision differential pressure sensor inside the ventilator. The pressure difference varies with flow (relationship determined during flow sensor calibration), so the patient's flow is determined from the pressure drop. The ventilator calculates volume from the flow measurements.





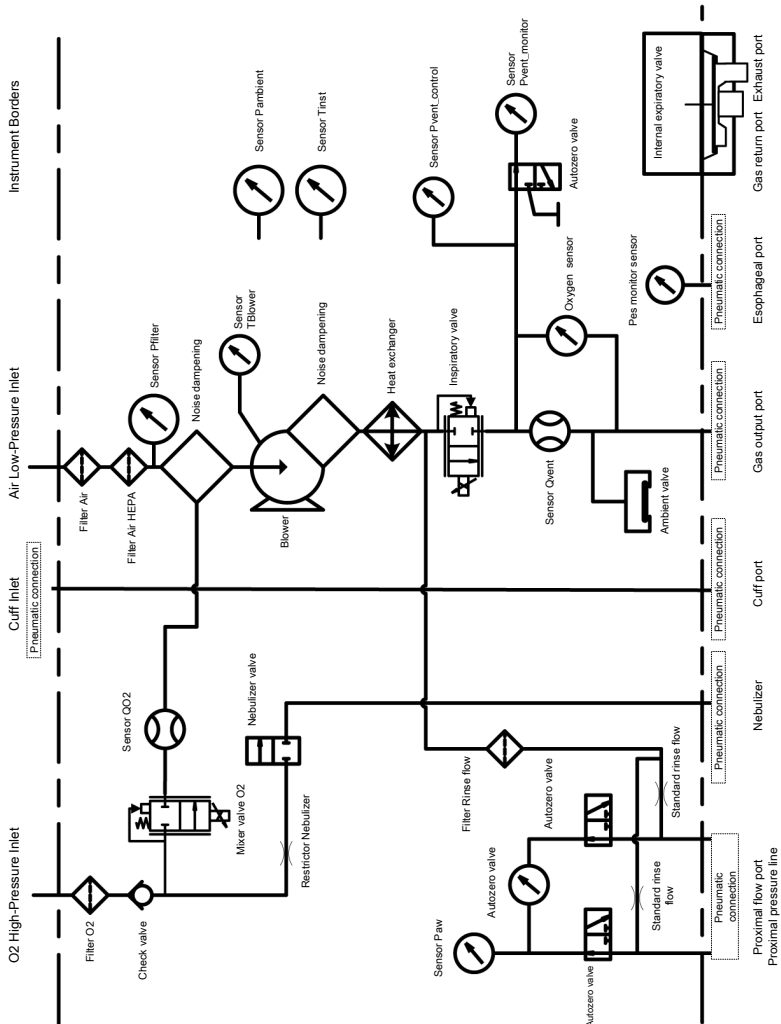





The flow sensor is highly accurate even in the presence of secretions, moisture, and nebulized medications. The ventilator flushes the sensing tubes with mixed gases (rinse flow) to prevent blockage.











16.12.3 Pneumatic diagram



















16.13 Symbols used on device labels and packaging

Table 16-16. Symbols used on device, device labels, and packaging

Symbol	Definition
	Power/Standby key
	Female patient
	Male patient
	Neonatal patient
	To patient inspiratory port
	From patient expiratory port
	Alarm Off
	Manufacturer
	Date of manufacture
	Refer to the operator's manual for complete information.
	Symbol for "Caution". Applied parts not protected against defibrillation.

Symbol	Definition
	CE Marking of Conformity, seal of approval guaranteeing that the device is in conformance with the Council Directive 93/42/EEC concerning medical devices
	The TÜV NRTL mark with the indicators "C" and "US" means that the product complies with Canadian requirements and the requirements of US authorities for safety.
	Dispose according to Council Directive 2002/96/EC or WEEE (Waste Electrical and Electronic Equipment)
	Serial number
	This way up at transport and storage
	Fragile, handle with care at transport and storage
	Keep dry at transport and storage
	Temperature limitations at transport and storage
	Humidity limitations at transport and storage
	Atmospheric pressure limitations at transport and storage
	Stacking limitations at transport and storage

Symbol	Definition
	Recyclable material
	Mass
	Single use
	<p>Autoclavable.</p> <p>Autoclavable parts can be used inside an autoclave (for example, a steam autoclave) without damage. These parts withstand temperatures up to approximately 134°C. The correct way to reprocess autoclavable parts is described in the <i>Reprocessing Guide</i> provided by the manufacturer.</p> <p>Parts that Hamilton Medical terms as <i>autoclavable</i> can undergo autoclaving with steam sterilization without damage.</p>
	<p>Reusable.</p> <p>A reusable part is a medical device or part of a medical device that can be reused if it undergoes some sort of reprocessing between use on different patients. The correct way to reprocess reusable parts is described in the <i>Reprocessing Guide</i> provided by the manufacturer.</p> <p>Parts that Hamilton Medical terms as <i>reusable</i> cannot be autoclaved with steam sterilization.</p>

Symbol	Definition
	Type B applied part (classification of medical electrical equipment, type B, as specified by IEC 60601-1)
	Type BF applied part (classification of medical electrical equipment, type BF, as specified by IEC 60601-1)
	Applicable to neonatal patient group
	Applicable to pediatric patient group
	Applicable to adult patient group
	Applicable to neonatal/pediatric patient groups
	Applicable to pediatric/adult patient groups
	Applicable to all patient groups
	Terminal for the connection of a potential equalization conductor.
IP22	Protected against dripping water when the device is tilted to a maximum of 15 degrees, and from solid particles larger than 12.5 mm.
	HAMILTON-C6 poses unacceptable risks to the patient, medical staff, or other persons within the MR environment.
	Chinese RoHS

16.13.1 Symbols used on the trolley

Figure 16-5. Trolley warning stickers



- | | |
|-------------------------------------|--|
| <p>1 Do not lean on the trolley</p> | <p>2 Weight
The maximum safe working load applies to a stationary, properly load-balanced trolley.</p> |
|-------------------------------------|--|

16.14 Standards and approvals

The HAMILTON-C6 was developed in accordance with pertinent international standards and FDA guidelines.

The ventilator is manufactured within an EN ISO 13485 and EN ISO 9001, Council Directive 93/42/EEC, Annex II, Article 3 certified quality management system.

The ventilator meets the Essential Requirements of Council Directive 93/42/EEC, Annex I.

Where standards are mentioned, the HAMILTON-C6 complies with the versions listed in Table 16-18.

The ventilator meets relevant parts of the following standards, listed in Table 16-17.

Table 16-17. Standards

IEC 60601-1	Medical electrical equipment, Part 1: General requirements for basic safety and essential performance. The device classification is: Class I, Type B applied part (ventilator breathing system, VBS), type BF applied part (CO2 sensor including CO2 module connector, humidifier, Aerogen system, nebulizer, and SpO2 sensor including SpO2 adapter), continuous operation
IEC 60601-1-2	Medical electrical equipment - Part 1-2: General requirements for basic safety and essential performance. <ul style="list-style-type: none"> • Collateral standard: Electromagnetic disturbances • Requirements and tests
IEC 60601-1-10	Medical electrical equipment - Part 1-10: General requirements for basic safety and essential performance. Collateral Standard: Requirements for the development of physiologic closed-loop controllers
ISO 80601-2-12	Medical electrical equipment - Part 2-12: Particular requirements for the basic safety and essential performance of critical care ventilators
CAN/CSA-C22.2 No. 60601.1	Medical electrical equipment: General requirements for safety

ANSI/AAMI ES 60601-1	Medical electrical equipment - Part 1: General requirements for basic safety and essential performance	IEC 61000-4-11:2004
EN ISO 5356-1	Anaesthetic and respiratory equipment - conical connectors - Part 1: Cones and sockets	EN ISO 5359:2008 + A1: 2011
EN ISO 5359	Low-pressure hose assemblies for use with medical gases	EN ISO 13485:2016
EN ISO 80601-2-55	Medical electrical equipment - Part 2-55: Particular requirements for the basic safety and essential performance of respiratory gas monitors	IEC 60950-1:2005 + AMD1:2009 + AMD2:2013
		ISO 15883-1:2006+A1:2014
		ISO 15883-2:2006
		ISO 15883-3: 2006
		ISO 15883-4:2008
		ISO 11607-1: 2006 + AMD1:2014
		EN ISO 9001:2008
		EN ISO 5356-1:2015
		ISO 4135:2001

Table 16-18. Standards and approvals, valid versions

IEC 60601-1-2:2014
IEC 60601-1:2005/A1:2012
ANSI/AAMI ES60601-1:2005/(R)2012
CAN/CSA-C22.2 No. 60601-1:14
IEC 60601-1-2:2014
ISO 80601-2-12:2011 + Cor.:2011
ISO 80601-2-55:2018
IEC 61000-3-2:2005
IEC 61000-3-3:2008
IEC 61000-4-2:2008
IEC 61000-4-3:2006 + A1:2007+A2:2010
IEC 61000-4-4:2004
IEC 61000-4-5:2005
IEC 61000-4-6:2003+A1:2004+A2:2006
IEC 61000-4-8:2009

16.15 Disposal and year of manufacture

Disposal

The device must be disposed of according to your institution's protocols and Directive 2002/96/EC.

All parts removed from the device must be considered contaminated, and pose infection risk.

Dispose of all parts removed from the device according to your institution's protocol. Follow all local, state, and federal regulations with respect to environmental protection, especially when disposing of the electronic device or parts of it (for example, O₂ sensor, batteries).

Year of manufacture

The year of manufacture is shown on the serial number label on the HAMILTON-C6 ventilation unit.

16.16 Warranty

LIMITED WARRANTY

THE WARRANTY DESCRIBED IN THIS AGREEMENT IS IN LIEU OF ANY AND ALL OTHER WARRANTIES, EXPRESS OR IMPLIED, INCLUDING IMPLIED WARRANTIES OF MERCHANTABILITY AND FITNESS FOR A PARTICULAR PURPOSE. HOWEVER, IMPLIED WARRANTIES ARE NOT DISCLAIMED DURING THE PERIOD OF THIS LIMITED WARRANTY.

Hamilton Medical guarantees its products to be shipped free from defects in material and workmanship.

The warranty does not include disposable items. Disposable items and consumable products are considered to be of single use or of limited use only and must be replaced regularly as required for proper operation of the product following the operator's manual.

Hamilton Medical shall have no obligations nor liabilities in connection with the product other than what is specified herein, including without limitation, obligations and/or liabilities for alleged negligence, or for strict liability.

In no event shall the company be liable for incidental or consequential damages, either direct or contingent.

This Limited Warranty shall be void and not apply:

1. If the product has not been installed and connected by an authorized local representative of Hamilton Medical in accordance with the instructions furnished by Hamilton Medical and by a Hamilton Medical representative.
2. If replacements and/or repairs have not been performed by authorized or properly trained personnel.
3. If no evidence is present that the occurrence of damage/ repair happened within the certified warranty period.
4. If the serial number has been altered, effaced or removed and there is no bill of sale or evidence to verify the product's purchase date.
5. If the defects arise from misuse, negligence, or accidents or from repair, adjustment, modification or replacement made outside Hamilton Medical's factories or other than an authorized service center or authorized service representative.
6. If the product has been modified, or in any nature altered without prior written authorization from Hamilton Medical.
7. If yearly maintenance is not performed.
8. If the product is or has been used in any way that is not specified under "Intended Use" (see "General cautions and notes").

9. If the product has been used by anyone but properly trained personnel under the supervision of a physician. Replacements and/or repairs furnished under this Limited Warranty do not carry a new warranty, but carry only the unexpired portion of the original Limited Warranty. The warranty of repaired and/or replaced components does not exceed the Limited Warranty of the device.

To obtain service under this Limited Warranty, claimant must promptly notify the country's sales partner of Hamilton Medical regarding the nature of the problem, serial number and the date of purchase of the Product.

Except as stated above, Hamilton Medical shall not be liable for any damages, claims or liabilities including, but not limited to, personal bodily injury, or incidental, consequential, or special damages. Nor will Hamilton Medical be liable for any damages, claims or liabilities including, but not limited to, personal bodily injury, or incidental, consequential, or special damages resulting from misuse of the device or failure to comply with any of the provisions made in this manual.

The general terms and conditions of Hamilton Medical shall be applicable. This agreement shall be governed by and construed in accordance with the laws of Switzerland and may be enforced by either party under the jurisdiction of the court of Chur, Switzerland.

%MinVol

Percentage of minute ventilation, a control setting in the ASV and INTELLiVENT-ASV modes

(S)CMV

Synchronized controlled mandatory ventilation, a ventilation mode

(S)CMV+

See APVcmv

alarm lamp

Lamp on top of the ventilator that lights in the color corresponding to the active alarm

Alarm Off symbol

Displayed when the associated alarm limit is disabled (set to Off)

apnea

Cessation of breathing

APRV

Airway pressure release ventilation, a ventilation mode

APVcmv

Adaptive pressure ventilation with controlled mandatory ventilation, a ventilation mode; can also be shown as (S)CMV+ (configurable)

APVsimv

Adaptive pressure ventilation with synchronized intermittent mandatory ventilation, a ventilation mode; can also be shown as SIMV+ (configurable)

ASV

Adaptive support ventilation mode. ASV adjusts pressure and rate on a breath-by-breath basis, taking into account changing patient conditions and applying lung-protective strategies to meet the targets.

ASV Graph

An Intelligent panel that shows ASV target and patient data graphically, available in ASV mode

AutoPEEP

Unintended positive end-expiratory pressure, a monitored parameter

b/min

Breaths per minute

backup

Apnea backup ventilation

backup buzzer

A buzzer that sounds for at least 2 minutes in certain conditions; also functions as a backup for the ventilator loudspeaker

base flow

A continuous and constant gas flow from the inspiratory outlet to the expiratory outlet

breathing circuit

Breathing limbs and components used to deliver respiratory gases to the patient

BTPS

Body temperature, barometric pressure at sea level, saturated with water vapor

CE

A certification mark that indicates compliance with the Medical Device Directive, 93/42/EEC

control

A virtual dial, slider or other input icon on the display that allows you to specify the value of a setting

control setting, control parameter

Any setting that the ventilator uses as an input for the delivered ventilation therapy. For example, PEEP/CPAP, IBW or Weight, Vt, and so on. Note that some control settings, such as IBW, are not directly specified by the user.

COPD

Chronic obstructive pulmonary disease

CPAP

Continuous positive airway pressure

CSA

Canadian Standards Association

Cstat

Static compliance, a monitored parameter

DAS

Distributed alarm system

DISS

Diameter index safety standard, a standard for high-pressure gas inlet fittings

Driving pressure (ΔP)

A calculated value showing the ratio of tidal volume to static compliance, which reflects the difference between Pplateau and PEEP total; can provide information to help optimize ventilation for ARDS patients

DuoPAP

Duo positive airway pressure, a ventilation mode

Dynamic Lung

Intelligent panel that graphically represents tidal volume, lung compliance, patient triggering, and resistance in real time

EMC

Electromagnetic compatibility

EMI

Electromagnetic interference

EN

European norm, a European standard

ETS

Expiratory trigger sensitivity is the percent of peak inspiratory flow at which the ventilator cycles from inspiration to exhalation. Increasing the ETS setting results in a shorter inspiratory time. The ETS setting lets you match the inspiratory time of pressure-supported breaths to the patient's neural timing.

event log

A record of clinically relevant ventilator occurrences, including alarms, settings changes, calibrations, maneuvers, and special function uses that have occurred since the ventilator was turned on

Exp Flow

Peak expiratory flow, a monitored parameter

ExpMinVol

Expiratory minute volume, a monitored parameter and alarm setting; in the Vent Status panel, ExpMinVol is the percentage of normal minute ventilation based on IBW

f

Respiratory rate

fControl

Mandatory breath frequency, a monitored parameter

FDA

United States Food and Drug Administration

FetCO2

Fractional end-tidal CO2 concentration, a monitored parameter

fSpont

Spontaneous breathing frequency, a monitored parameter

fTotal

Total breathing frequency, a monitored parameter and alarm setting

HEPA

High efficiency particle air filter

HiFlowO2

High flow oxygen therapy

HME, HMEF

Heat and moisture exchanger (artificial nose), heat and moisture exchanging filter

HPO

High-pressure oxygen

I

Inspiration

I:E

Ratio of inspiratory time to expiratory time, a setting, timing parameter, and monitored parameter

IBW

Ideal body weight, a calculated value for adult and pediatric patients based on the patient's sex and height; used as the basis for initial settings of various parameters

ID

Inner diameter

IEC

International Electrotechnical Commission

Insp Flow

Peak inspiratory flow, a monitored parameter

inspiratory hold

An inspiratory hold closes the inspiratory and expiratory valves for a short time. Perform this maneuver to calculate true plateau airway pressure.

inspiratory pressure

The total inspiratory pressure to be applied during ventilation. In some modes this is the sum of the pressure control + PEEP/CPAP

IntelliCuff

Cuff pressure controller

Intelligent Panel

A type of graphic display on the ventilator

IntelliTrig

Intelligent trigger, a feature that ensures that the set trigger sensitivity can trigger a breath independent from leakage and breath pattern

INTELLiVENT-ASV

Fully closed loop ventilation solution, automatic MinVol, PEEP, and Oxygen adjustment based on physiological patient condition

Interaction panel (IP) or panel

The technical term used for the ventilator monitor

IRV

Inverse ratio ventilation

ISO

International Organization for Standardization

Loops

A special graphic type

loudness

Sets the volume for the audible ventilator alarms

LSF

Least squares fitting method; a mathematical procedure for finding the best fitting curve for a given set of points by minimizing the sum of the squares of the offsets of the points from the curve

mandatory breath

The start of inspiration (triggering) is determined by the ventilator or the patient. The end of inspiration (cycling) is determined by the ventilator.

manual breath

A user-triggered mandatory breath started by pressing the Manual breath key

MinVol

Minute volume, a calculated and monitored parameter used in ASV mode; based on the operator-set %MinVol, the ventilator calculates the target MinVol in l/min, then measures and displays this value in the ASV Graph

monitor

The physical hardware that has the touch screen and function keys; also referred to as the interaction panel

MVLeak

Total minute volume leakage; MVLeak shows $V_{Leak} \times \text{frequency}$ (respiratory rate)

MVSpont

Spontaneous expiratory minute volume, a monitored parameter

nCPAP-PS

A neonatal ventilation mode that offers nasal continuous positive airway pressure - pressure support through a nasal interface (mask or prongs) for infants and neonates

NIST

Noninterchangeable screw thread, a standard for high-pressure gas inlet fittings

NIV

Noninvasive ventilation, a ventilation mode

NIV-ST

Spontaneous/timed noninvasive ventilation, a ventilation mode

NPPV

Noninvasive positive pressure ventilation

OD

Outer diameter

Oxygen

Oxygen concentration of the delivered gas, a control setting and a monitored parameter

P high

High pressure in APRV and DuoPAP modes

P low

Low pressure setting in APRV mode

P0.1

Airway occlusion pressure, a monitored parameter

Pat. height

Patient height; a control setting used to compute the patient's ideal body weight (IBW) in calculations for ASV and startup settings

patient group

A control setting used to define initial startup settings for the patient; options are Adult/Ped (adult and pediatric patients) and Neonatal

Paw

Airway pressure

Pcuff

Cuff pressure, a monitored parameter (for the IntelliCuff cuff pressure controller)

PCV+

Pressure controlled ventilation, a ventilation mode

PEEP/CPAP

PEEP (positive end-expiratory pressure) and CPAP (continuous positive airway pressure), a control setting and monitored parameter; PEEP and CPAP are constant pressures applied during both the inspiratory and expiratory phases

PetCO₂

Partial pressure of end-tidal CO₂, the measure of CO₂ present in the exhaled air

Plimit

Maximum pressure to apply during ventilation, a control setting

Pmean

Mean airway pressure, a monitored parameter

PN

Part number

Ppeak

Peak airway pressure, a monitored parameter

Pplateau

Plateau or end-inspiratory pressure

P-ramp

Pressure ramp, a control setting

Press-and-turn knob

See P&T knob

pressure trigger

The patient's inspiratory effort that causes the ventilator to deliver a breath, a control setting

PSIMV+

Pressure-controlled synchronized intermittent mandatory ventilation, a ventilation mode

PTP

Inspiratory pressure time product, a monitored parameter

Rate

Breath frequency or number of breaths per minute, a control setting

RCexp

Expiratory time constant, a monitored parameter

Rinsp

Inspiratory flow resistance, a monitored parameter

RSB

Rapid shallow breathing index, a monitored parameter

Sex

Sex of patient, a control setting

sigh

Breaths delivered to deliberately increase tidal volume at a regular interval. If enabled, a sigh breath with an additional 10 cmH₂O is delivered every 50 breaths. Note that in volume-controlled modes, a sigh breath delivering 150% of the set tidal volume is delivered every 50 breaths.

SIMV

Synchronized intermittent mandatory ventilation, a ventilation mode

SIMV+

See APVsimv

slopeCO₂

Slope of the alveolar plateau in the PetCO₂ curve, a monitored parameter

SPONT

Spontaneous (pressure support) mode of ventilation, a ventilation mode

spontaneous breath

A breath for which both the inspiratory and expiratory triggers are controlled by the patient; the patient both triggers and cycles the breath

Standby

The ventilator is in a waiting state; there is no breath delivery

STPD

Standard temperature and pressure, dry; defined as dry gas at 0°C (32°F) at 758 mmHg (101 kPa) pressure at sea level

T high

Set time interval for the high pressure level in the APRV and DuoPAP modes

T humidifier

Measured temperature at the humidifier water chamber exit, a monitored parameter (for HAMILTON-H900 humidifier only)

T low

Set time interval for the low pressure level in APRV mode

T Y-piece

Measured temperature at the humidifier Y-piece, a monitored parameter (for HAMILTON-H900 humidifier only)

TE

Expiratory time, a monitored parameter

technical fault

A type of alarm generated when the ventilator's ability to safely ventilate the patient may be at risk

TI

Inspiratory time, a control setting and monitored parameter

TI max

Maximum inspiratory time, a control setting

touch screen

The glass portion of the monitor that you touch to interact with the display elements

Trends

A special graphic type

trigger

The patient's inspiratory effort that causes the ventilator to deliver a breath, a control setting; controlled by flow, pressure, or IntelliSync+

V'alv

Alveolar minute ventilation, a monitored parameter

V'CO₂

Net exhaled volume of CO₂, a monitored parameter

VDaw

Airway dead space

VDaw/VTE

Airway dead space fraction at the airway opening, a monitored parameter

VeCO2

Expiratory CO2 volume, a monitored parameter

Vent Status panel

An Intelligent Panel that illustrates six parameters related to the patient's ventilator dependence, including oxygenation and patient activity

ventilator breathing system (VBS)

A breathing system bounded by the low-pressure gas input port(s), the gas intake port(s), and the patient connection port, together with the fresh-gas inlet and exhaust port(s), if fresh-gas inlet or exhaust ports are provided, as described in ISO 4135

ViCO2

Inspiratory CO2 volume, a monitored parameter

VLeak

Leakage percent, a monitored parameter

Vt

Tidal volume; a control setting, alarm setting, and monitored parameter

Vt/IBW

Tidal volume calculated according to ideal body weight, used for adult/pediatric patients; a monitored parameter

Vt/Weight

Tidal volume calculated according to actual body weight, used for neonatal patients; a monitored parameter

Vtalv

Alveolar tidal ventilation, a monitored parameter

VTE

Expiratory tidal volume, a monitored parameter; it is the integral of all negative flow measurements during exhalation

VTESpont

Spontaneous expiratory tidal volume, a monitored parameter

VTI

Inspiratory tidal volume, a monitored parameter

Waveforms

A special graphic type

 Δ Pcontrol

Pressure control, a control setting in PCV+ and PSIMV+ modes; pressure (additional to PEEP/CPAP) to be applied during the inspiratory phase

 Δ Pinsp

Inspiratory pressure, the target pressure (additional to PEEP/CPAP) to be applied during the inspiratory phase. Set by the operator in the PSIMV +PSync and NIV-ST modes; displayed in the Vent Status panel and the ASV Graph.

 Δ Psupport

Pressure support, a control setting valid during spontaneous breaths in SPONT, APVsimv, PSIMV+PSync, DuoPAP, and NIV modes. Δ Psupport is pressure (additional to PEEP/CPAP) to be applied during the inspiratory phase.

Icons

- (S)CMV ventilation mode 129
- (S)CMV+ / APVcmv ventilation mode 133

A

- accessories, list of 298
- Aerogen
 - activating option 294
- Aerogen nebulizer
 - enabling use of 293
 - setup overview 80
- air/dust filters, replacing 283
- alarm test, about 91
- alarms
 - about 196
 - active, viewing 203
 - Audio pause, enabling 202
 - buffer, about 203
 - buffer, shortcut 59
 - HAMILTON-H900 humidifier 261
 - i-icon (alarm buffer) 203
 - inactive, viewing 203
 - indicators, about 196, 197
 - IntelliCuff, about 272
 - limit disabled symbol 201
 - limits, setting 104
 - limits, where shown 201
 - list of 205
 - loudness, setting 204
 - on-screen help, accessing 204
 - Oxygen limits, setting manually 289
 - responding to 202
 - silencing (Audio pause) 202
 - status indicator on ventilator 48
 - troubleshooting 205
- alarms, adjustable
 - about 105
 - Apnea time 106
 - ExpMinVol 106
 - fTotal 106
 - limits, setting 105
 - Oxygen 106
 - PetCO2 106
 - Pressure 106
 - Vt 107
- Ambient state 151

- Apnea backup 101
- Apnea time alarm 106
- APRV ventilation mode 140
- APVcmv / (S)CMV+ ventilation mode 133
- APVsimv / SIMV+ ventilation mode 134
- ASV Graph
 - about 183
 - displaying 183
- ASV ventilation mode 142
 - maintaining adequate ventilation 158
 - monitoring ventilation 159
 - weaning, overview 160
 - working with 156
- Audio pause (alarm silence)
 - alarms not affected 201, 226
 - enabling/canceling 202

B

- batteries
 - about 62
 - power states, about 63
 - remaining charge/time, shortcut 59
 - status indicator on ventilator 48
 - storage 285
- breath timing options 124
 - selecting 290
- breath types 124
- breathing circuit diagrams (Adult/Ped)
 - high flow oxygen 51
- breathing circuit diagrams (adult/pediatric)
 - coaxial with HMEF 50
 - dual limb with humidifier 50
- breathing circuit diagrams (Neo)
 - high flow oxygen 53
 - nCPAP-PS 54
 - with HMEF 52
 - with humidifier 52

- breathing circuits
 - connection overview 64
 - expiratory valve, installing 65
 - filters, using in 66
 - flow sensor, connecting 67
 - key connection ports on ventilator 64
 - positioning 68, 118
 - selecting components for (Adult/ Ped) 65
 - selecting components for (Neo) 117
- buffer, alarm 203

C

- calibration
 - CO2 sensor/adapter 89
 - flow sensor 87, 120
 - O2 sensor 88
 - Tests & calibs window, accessing 84
- Check flow sensor for water alarm 209
- cleaning components and ventilator
 - agents for touch screen 281
 - cleaning agents 280
 - general guidelines 278
- CO2 alarms 106, 326
- CO2 measurement
 - activating option 294
 - enabling 78
 - mainstream monitoring, about 74
 - overview 74
 - sidestream monitoring, about 76
 - zero calibration, performing 89
- communication (COM) interface, selecting 288
- configuration
 - Aerogen, activating option 294
 - alarm loudness, setting minimum 289
 - breath timing options, selecting 290
 - CO2, activating option 294
 - communication (COM) interface, selecting 288
 - Configuration mode, accessing 288
 - copying configuration settings to other devices 293
 - distributed alarm system 288
 - flow sensor water sensitivity, setting 289
 - hardware options, activating/deactivating 294, 295
 - language, selecting 288
 - MMPs, selecting what to show 291

- mode naming, selecting 290
- Oxygen limits, setting manually 289
- Quick setups, defining 291
- SMPs, selecting what to show 291
- software options, activating 293
- software options, removing 294
- SpO2, activating option 294
- TI max, enabling for invasive modes 291
- units of measure, selecting 288
- control parameters
 - defined 108
 - settings, changing 58, 231
- control shortcuts 57
- Controls window
 - opening 92
 - settings for ventilation, adjusting 92
- Cstat parameter
 - in Dynamic Lung 179

D

- data transfer, copying configuration settings 293
- date/time
 - shortcut to settings window 59
- date/time, setting 239
- device information, viewing 194
- disinfecting components, guidelines for 278
- display
 - brightness, setting 240
 - errors, about 151
 - navigating 57
 - shortcuts 57
 - shortcuts, using 59
- Distributed alarm system (DAS) 225
- documentation
 - conventions used in manual 18
 - manuals for ventilator, list of 17
- DuoPAP ventilation mode 139
- Dynamic Lung
 - about 178
 - airway resistance (Rinsp) 180
 - compliance (Cstat) 179
 - displaying 180
 - IntelliCuff data 180
 - patient trigger 180
 - SpO2 data 180

E

- EMC-related safety information 22
- esophageal pressure
 - measuring 183
 - setting up for monitoring 68
- event log
 - about 241
 - copying 241
 - viewing 241
- expiratory hold, performing 235
- expiratory valve, installing 65

F

- filters, using in breathing circuit 66
- flow sensor
 - calibration 87, 120
 - connecting 67
 - connecting (adult/pediatric) 67
 - connecting (Neo) 118
 - water sensitivity (Neo), setting 289
- function keys on front of ventilator, about 231

G

- gas supply
 - connecting 63
 - functional description of 342
- graphics on display
 - contents of, changing 171
 - Intelligent panels, about 178
 - layout, changing 171
 - loops 177
 - trends 176
 - types of 171
 - waveform view options 173

H

- Hamilton Medical College website 18
- HEPA filter
 - replacing 283
- high flow oxygen 148
 - breathing circuit diagrams (Adult/Ped) 51

- breathing circuit diagrams (Neo) 53
- delivering 149
- safety information 33
- hold
 - inspiratory, performing 235
- Home button, shortcut 59
- humidifier
 - connecting 72
 - setup overview 72
- humidifier (HAMILTON-H900)
 - adjustable controls, about 258
 - alarms 260, 261
 - connecting to ventilator 72
 - connection to ventilator, verifying 256
 - controls on ventilator, accessing 255
 - data, where displayed 263
 - integration with ventilator, about 254
 - parameters, list of 263
 - quick access button, about 256
 - settings, changing 259
 - software version, viewing 194
 - Standby, entering 259
 - turning on/off 259
 - window shortcut 59
- humidifier alarms (HAMILTON-H900)
 - alarm sound, pausing (silencing) 260
 - list of 261
 - status indicators, about 256
 - troubleshooting 261
 - where/how displayed 260
- humidifier modes and controls (HAMILTON-H900)
 - Auto/Manual control modes 257
 - Exp. temperature increase parameter 259
 - HAMILTON-H900 parameter 263
 - humidifier operating modes, about 257
 - Invasive, NIV, HiFlowO2 256
 - Set temp parameter 258
 - T gradient parameter 259
 - T humidifier parameter 263
 - T y-piece parameter 263

I

- i-icon (alarm buffer), about 203
- inspiratory hold, performing 235
- IntelliCuff
 - alarms 271
 - connecting to patient/ventilator 73
 - connection to ventilator, verifying 266

- controls on ventilator, accessing 264
 - cuff pressure, setting 268
 - deflating cuff 270
 - hold, performing 270
 - integration with ventilator 73
 - Last Patient settings used 275
 - parameters, list of 274
 - quick access button, about 266
 - software version, viewing 194
 - status indicators, about 266
 - tubing, about 73
 - turning on/off 266, 267
 - window shortcut 59
 - working with, overview 264
 - IntelliCuff alarms
 - list of 272
 - troubleshooting 272
 - where/how indicated 271
 - IntelliCuff modes and controls
 - Auto/Manual control modes, about 267
 - cuff pressure during recruitment 269
 - Cuff pressure parameter 274
 - IntelliCuff parameter 274
 - Max. pressure parameter 274
 - Min. pressure parameter 274
 - parameters, list of 274
 - Pcuff parameter 180, 274
 - Rel. pressure parameter 274
 - Intelligent panels
 - about 178
 - ASV Graph 183
 - Dynamic Lung 178
 - Monitoring (SMPs) 169
 - Vent Status 181
 - IntelliSync+
 - about 98
 - INTELLiVENT-ASV ventilation mode 144
 - interaction panel (monitor) errors, about 151
- K**
- keys on front of ventilator, about 231
- L**
- language, setting 288
 - leak alarms 106, 326
 - Leak test
 - performing 86
 - list items, selecting 59
 - loops
 - about 177
 - displaying 178
 - storing 178
 - loudness, setting for alarms 204
- M**
- main monitoring parameters (MMPs)
 - alarm limits shortcut 59
 - selecting what to show 291
 - viewing 168
 - mainstream CO2 measurement
 - about 74
 - setting up 75
 - maintenance
 - air/dust filters, replacing 283
 - battery, storage 285
 - HEPA filter, replacing 283
 - preventive 282
 - manual breath, delivering 234
 - modes
 - accessing shortcut 59
 - naming convention, selecting 290
 - monitor, adjusting tilt angle and position 55
 - monitored parameters
 - defined 185
 - specifications for 318
 - Monitoring panel (SMPs)
 - displaying 170
 - selecting what to show 291
 - monitoring ventilation
 - about 168
 - main monitoring parameters (MMPs) 168
 - parameter values, viewing graphically 171
 - parameter values, viewing numeric 168
 - secondary monitoring parameters (SMPs), about 169
 - MyHamilton website 18

N

- navigating the display 57
 - nCPAP-PS ventilation mode 147
 - nebulizer
 - Aerogen, setup overview 80
 - configuring 293
 - overview 78
 - pneumatic, about 237
 - pneumatic, setting up 79
 - pneumatic, setup overview 79
 - starting/stopping 237, 238
 - neonatal ventilation
 - breathing circuit diagrams 52, 53, 54
 - breathing circuit, setting up 117
 - flow sensor, connecting 118
 - patient data, entering 116
 - preoperational check, overview 119
 - setting up for 116
 - NIV ventilation mode 145
 - NIV-ST ventilation mode 146
 - noninvasive (NIV) ventilation
 - alarms during 154
 - conditions for use 152
 - contraindications for use 153
 - notes for use 155
 - working with 152
- ## O
- O₂ enrichment, delivering 233
 - O₂ sensor
 - calibrating 88
 - enabling 78
 - options
 - hardware, activating/deactivating 294, 295
 - removing software 294
 - reviewing 194
 - Oxygen
 - alarm limits, setting manually 289
 - oxygen alarms 106, 326
 - Oxygen parameter
 - alarm 107
 - oxygen supply, connecting 63

P

- P/V Tool Pro
 - about 244
 - accessing 246
 - contraindications for use 245
 - maneuver data, reviewing 251
 - maneuver data, views of 248
 - maneuver, performing 248
 - recruitment maneuver, performing 252
 - reference curves, about 251
 - settings, adjusting 247
 - using 245
 - when to use 244
- parameters, control
 - %MinVol 108
 - Apnea backup 108
 - ETS 108
 - Flow 108
 - Flow pattern 108
 - I:E 108
 - IBW 109
 - Oxygen 109
 - P high 109
 - P low 109
 - Pat. height 109
 - Pause 109
 - Peak flow 109
 - PEEP/CPAP 109
 - Plimit 109
 - P-ramp 110
 - Rate 110
 - Sex 110
 - Sigh 110
 - T high 110
 - T low 110
 - TI 111
 - TI max 111
 - Tip 111
 - TRC related 112
 - trigger, expiratory 112
 - trigger, inspiratory 112
 - Vt 113
 - Vt/kg 113
 - Weight 113
 - $\Delta P_{control}$ 113
 - ΔP_{insp} 113
 - $\Delta P_{support}$ 113
- parameters, monitored
 - AutoPEEP 185
 - Cstat 189
 - Driving pressure, ΔP 185
 - Exp Flow 187

- ExpMinVol 187
- fControl 188
- FetCO2 191
- Flow 186
- fSpont 188
- fTotal 188
- I:E 188
- Insp Flow 187
- MinVol NIV 187
- MV Spont 187
- MVLeak 187
- MVSpont NIV 187
- Oxygen 189
- P0.1 189
- Pcuff 191
- PEEP/CPAP 185
- Pes max 185
- Pes min 185
- Pes P0.1 185
- Pes plateau 185
- Pes PTP 185
- PetCO2 192
- Pmean 186
- Ppeak 186
- Pplateau 186
- Pprox 186
- PTP 190
- Ptrans E 186
- Ptrans I 186
- RCexp 190
- Rinsp 191
- RSB 191
- slopeCO2 192
- T humidifier 191
- T y-piece 191
- TE 188
- TI 189
- V'alv 192
- V'CO2 192
- VDaw 192
- VDaw/VTE 192
- VeCO2 192
- Ventilation time 191
- ViCO2 193
- VLeak 187
- Vt/IBW 188
- Vt/Weight 188
- Vtalv 193
- VTE 187
- VTE NIV 187
- VTESpont 187
- VTI 188
- ΔPinsp 186
- parameters, specifications for control 312
- parameters, specifications for monitored 318
- parts, list of 298
- patient data
 - changing 230
 - entering 83
 - main monitoring parameters (MMPs) 168
 - secondary monitoring parameters (SMPs), about 169
 - viewing graphically 171
 - viewing numeric data 168
- patient setup
 - entering patient data 82, 116
 - overview of 82
 - Quick setups, about 83
- Paw (pressure/time) waveform, about 175
- PCV+ ventilation mode 136
- Pes port on ventilator, about 183
- Plimit, working with the control 93
- power supply
 - batteries, about 62
 - power states, about 63
 - primary power, connecting to 62
 - status indicators on ventilator 48
- preconfigured settings (Quick setups), about 83
- preoperational check
 - flow sensor calibration, performing 87, 120
 - Leak test, performing 86
 - overview 84, 85
 - overview of 119
 - performing 85, 119
 - test breathing circuit setup (adult/pediatric) 85
 - test breathing circuit setup (Neo) 119
 - testing alarms 91
 - Tests & calibs window, accessing 84
- preparing for ventilation, overview 62
- pressure
 - esophageal, measuring 183
 - transpulmonary, calculating 183
- pressure alarms 106, 326

pressure-control settings, working with 93
 PSIMV + PSync ventilation mode 138
 PSIMV+ ventilation mode 137
 Pulse oximetry, about 77

Q

Quick setups
 about 83
 defining 291

R

rate alarms 106, 326
 regulatory standards, compliance with 23, 348
 Rinsp parameter
 in Dynamic Lung 180

S

safety information 22
 alarms 33
 apnea backup 32
 breathing circuits and accessories 26
 CO2 sensors 28
 electrical 25
 EMC 22
 fire/hazards 23
 gas supply 25
 general operation and setup 23
 high flow oxygen 33
 humidifiers 27
 IntelliCuff 28
 maintenance and cleaning/disinfection 34
 maintenance, cleaning/disinfection 35
 monitoring 33
 nebulization 30
 neonatal ventilation 31
 noninvasive ventilation 33
 O2 sensor 36
 P/V Tool Pro 32
 patient settings 31
 power and batteries 25
 preoperational checks 27
 preventive maintenance 36
 service and testing 37

TRC 32
 trolley 34
 USB port 26
 Safety ventilation, about 150
 screenshot of display, capturing 239
 secondary monitoring parameters (SMPs)
 displaying 169
 selecting what to show 291
 sensors, enabling 78
 setting up for ventilation, overview 62
 Setups button, Configuration 291
 shortcuts, using 59
 sidestream CO2 measurement
 about 76
 setting up 77
 SIMV ventilation mode 130
 SIMV+ / APVsimv ventilation mode 134
 software options
 activating on ventilator 293
 removing 294
 software version, viewing 194
 specifications
 accuracy testing 341
 adjustable alarms 326
 ASV technical data 332
 breathing system 334
 configuration 329
 dimensions 306
 disposal 349
 electrical 310
 environmental 308
 essential performance 341
 functional description of system 342
 gas monitoring description 343
 gas supply/delivery description 342
 monitored parameters 318
 pneumatic 309
 pneumatic diagram 345
 standards/approvals 348
 symbols used on labels 348
 technical performance data 335
 year of disposal 349
 SpO2 measurement
 about 77
 activating option 294
 data displayed in Dynamic Lung 180
 enabling 78
 SPONT ventilation mode 141

- Standby
 - entering 108
 - entering/exiting 231
- starting/stopping ventilation 107, 108
- status indicators on ventilator 48
 - active ventilation 48
 - alarm 48
 - battery 48
 - power 48
- suctioning, performing 233
- System Info window, viewing device info 194
- system information, viewing 194

T

- TI max parameter
 - enabling for invasive modes 291
- time scale of waveforms, changing 175
- time/date, setting 239
- touch screen
 - cleaning agents for 281
- touch screen, locking/unlocking 238
- transfer configuration settings 293
- transport, preparing trolley for 55
- transpulmonary pressure
 - calculating 183
 - setting up 68
- TRC (tube resistance compensation), about 102
- trends
 - about 176
 - displaying 177
 - freezing 176
- trigger, expiratory
 - about 98
 - ETS (E) 98
 - IntelliSync+ (I) 98
 - selecting 98
 - selecting type of 96
- trigger, expiratory defined 112
- Trigger, inspiratory
 - about 96
 - flow (F) 96
 - IntelliSync+ (I) 96
 - pressure (P) 96
 - selecting 97
 - selecting type of 96

- trigger, inspiratory defined 112
- troubleshooting
 - alarms 205
 - CO2 sensor zero calibration failure 91
 - flow sensor calibration failure 88
 - HAMILTON-H900 humidifier alarms 261
 - IntelliCuff alarms 272
 - Leak test failure 86
 - O2 sensor calibration 89
- turning the ventilator on/off 69

U

- USB port, location of 47

V

- Vent Status panel
 - about 181
 - displaying 183
 - weaning zone, configuring 292
- ventilation
 - alarms, working with 196
 - changing patient data during 230
 - control parameters, defined 108
 - monitored parameters, list of 184
 - monitoring, overview 168
 - neonatal, setting up for 116
 - preparing for, overview 62
 - settings, changing 231
 - Standby, entering/exiting 231
 - starting/stopping 107, 108
 - status indicator on ventilator 48
- ventilation modes
 - ASV, working with 156
 - changing 92
 - control settings, adjusting 92
 - modes, list of 126
 - noninvasive ventilation, working with 152
 - overview 124
 - selecting 91
- ventilation modes, list of
 - (S)CMV 129
 - Ambient state 151
 - APRV 140
 - APVcmv 133
 - APVsimv (SIMV+) 134
 - ASV 142
 - DuoPAP 139

- high flow oxygen 148
- INTELLiVENT-ASV 144
- nCPAP-PS 147
- NIV 145
- NIV-ST 146
- PCV+ 136
- PSIMV+ 137
- PSIMV+PSync 138
- Safety ventilation 150
- SIMV 130
- SPONT 141
- ventilation parameters
 - control settings 108
 - monitored 185
 - specifications for control 312
 - specifications for monitored 318
- ventilation settings
 - entering patient data 82, 116
 - how to adjust 58
 - preconfigured settings (Quick setup),
 - about 83
- ventilation timer
 - about 193
 - resetting 193
- ventilator
 - cleaning agents for 280
 - controls, how to use 58
 - features/options, overview of 40, 41
 - hardware options, overview of 42
 - intended use 19
 - navigating the display 57
 - patient setup, overview 82
 - turning on/off 69
- ventilator body
 - front view 45
 - rear view 46
- ventilator monitor
 - front view 44
 - rear view 47
- volume alarms 106, 326

Z

- zero calibration
 - performing for CO2 sensor/adapter 89

W

- warranty 350
- waveforms
 - changing selection 174
 - display options 173
 - displaying 174
 - freezing 176
 - Pressure/time (Paw), about 175
 - time scale, changing 175



More information and free software simulation:

www.hamilton-c6.com



HAMILTON
MEDICAL



Hamilton Medical AG

Via Crusch 8, 7402 Bonaduz, Switzerland

+41 (0)58 610 10 20

info@hamilton-medical.com

www.hamilton-medical.com



medin Medical Innovations GmbH

Adam-Geisler-Strasse 1

DE – 82140 Olching