

Directions for Use

Alaris® System (with Alaris® PC unit, Model 8000)

Supports Guardrails® Suite MX with Guardrails® Point-Of-Care software and v9 Operating System software.

July 2010

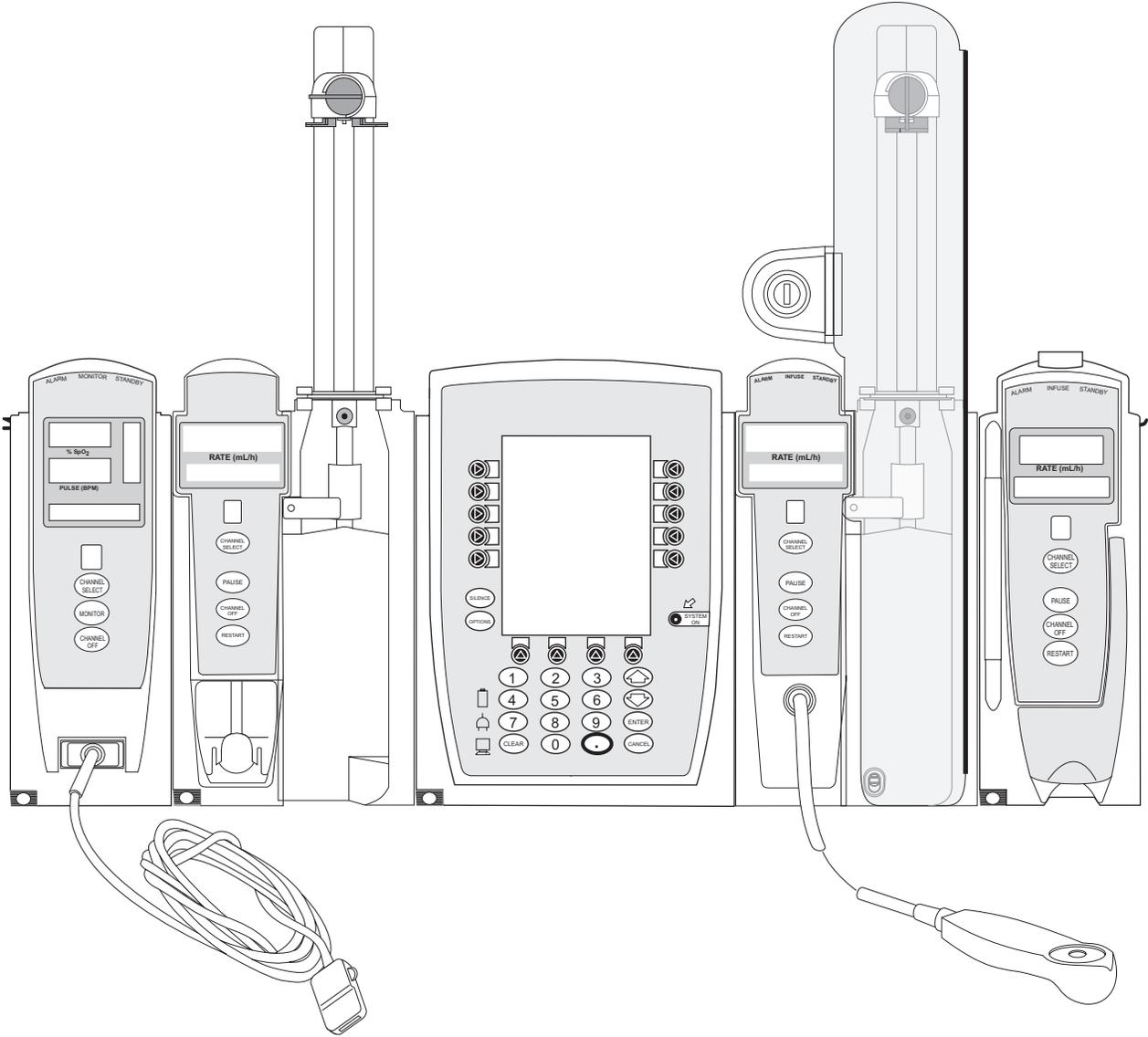

Table of Contents

Each of the Alaris® product-specific sections has its own table of contents.

General Contact Information	iii
Introduction	iv
Installation.....	vi
PC Unit	1
Pump and Syringe Modules	2
PCA Module	3
SpO ₂ Module.....	4
EtCO ₂ Module	5
Auto-ID Module	6
Nurse Call Accessory	7
Communications Interface Board Accessory	8
Appendix	
Maintenance.....	A-1
Cleaning	A-1
Service Information.....	A-3
Warranty	A-4
Regulations and Standards	A-5
Compliance	A-5
Trademarks	A-14

Order Numbers:

CD Version: 11777362

Printed Copy: 11775730

© 2005-2010 CareFusion Corporation or one of its subsidiaries. All rights reserved.

General Contact Information

CareFusion
San Diego, California
United States

carefusion.com

Customer Advocacy - North America

(Clinical and technical feedback.)

Phone: 888.876.4287

E-mail: CustomerFeedback@carefusion.com

Technical Support - North America

(Maintenance and service information support; troubleshooting.)

Phone, United States: 888.876.4287

Phone, Canada: 800.387.8309

Customer Care - North America

(Product return, service assistance, and order placement.)

Phone, United States: 888.876.4287

Phone, Canada: 800.387.8309

Introduction

The Alaris® PC unit section of this Directions for Use (DFU) provides procedures and information applicable to the Alaris® System and the PC Unit. Each of the other major sections provides product-specific procedures and information.

The Alaris® System is a modular system intended for adult, pediatric and neonatal care in today's growing professional healthcare environment. It consists of the PC Unit, the Guardrails® Suite MX, and up to four detachable infusion and/or monitoring modules (channels). The Auto-ID Module can be included as a fifth module.

Guardrails® Suite MX for the Alaris® System brings a new level of medication error prevention to the point of patient care. The Guardrails® Suite MX features medication dosing, concentration delivery rate and optional initial programming guidelines for up to 15 patient-specific care areas, referred to as profiles. Each profile contains a specific Drug Library, an IV Fluid library and channel labels, as well as instrument configurations appropriate for the care area. Optional drug- or IV Fluid-specific Clinical Advisories provide visual messages. Dosing limits for each Guardrails® drug entry or rate limits for each IV Fluid entry can be a Hard Limit that cannot be overridden during infusion programming and/or a Soft Limit that can be overridden, based on clinical requirements.

A Data Set is developed and approved by the facility's own multi-disciplinary team using the Editor Software, the PC-based authoring tool. A Data Set is then transferred to the Alaris® System by qualified personnel. The approved Data Sets are maintained by the Editor Software for future updates and reference.

Information about an Alert that occurs during use is stored within the PC Unit, and can be accessed using the CQI Reporter.

Documentation provided with Alaris® System products might reference product not present in your facility or not yet available for sale in your area.

A superscript number (for example, ^①) identifies additional information provided as a NOTE at the end of the procedure.

WARNING

Read all instructions before using the Alaris® System.

CAUTION

Rx Only

Introduction (Continued)

WARNINGS AND CAUTIONS:

Product-specific warnings and cautions, covered in the applicable sections of this DFU, provide information needed to safely and effectively use the Alaris® System.

A **◀ DANGER ▶** is an alert to an imminent hazard which could result in serious personal injury and/or product damage if proper procedures are not followed.

A **WARNING** is an alert to a potential hazard which could result in serious personal injury and/or product damage if proper procedures are not followed.

A **CAUTION** is an alert to a potential hazard which could result in minor personal injury and/or product damage if proper procedures are not followed.

DEFINED TERMS:

The following table identifies the defined terms used throughout this document for certain products and product features.

Product/Feature	Defined Term
Alaris® Auto-ID module	Auto-ID Module
Alaris® EtCO ₂ module	EtCO ₂ Module
Alaris® Mobile Systems Manager	Mobile Systems Manager
Alaris® PCA module	PCA Module
Alaris® PC unit	PC Unit
Alaris® Pump module	Pump Module
Alaris® SpO ₂ module	SpO ₂ Module
Alaris® Syringe module	Syringe Module
Alaris® System Maintenance	System Maintenance
Alaris® Systems Manager	Systems Manager
Guardrails® alert	Alert

Introduction (Continued)

DEFINED TERMS: (Continued)

Product/Feature	Defined Term
Guardrails® clinical advisory	Clinical Advisory
Guardrails® CQI Reporter	CQI Reporter
Guardrails® data set	Data Set
Guardrails® drug library	Drug Library
Guardrails® Editor	Editor Software
Guardrails® hard limit	Hard Limit
Guardrails® IV fluid	IV Fluid
Guardrails® limit	Limit
Guardrails® PCA pause protocol	PCA Pause Protocol
Guardrails® soft limit	Soft Limit
SmartSite® needle-free valve	Needle-Free Valve
SmartSite® positive bolus needle-free valve	Needle-Free Valve

Installation

Instruments are tested and calibrated before they are packaged for shipment. To ensure proper operation after shipment, it is recommended that an incoming inspection be performed before placing the instrument in use.

Prior to placing the Alaris® System in use:

1. Perform check-in procedure using System Maintenance software.
2. Verify whether or not Profiles feature has been enabled (see PC Unit section, "System Options," "System Configurations").^①

NOTE:

- ^① To enable the Profiles feature, a hospital-defined best-practice Data Set must be uploaded to the PC Unit.

Alaris® PC Unit Model 8000

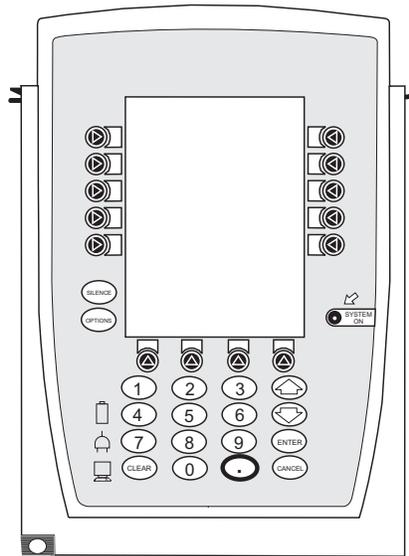

Getting Started

Introduction	1-1
--------------------	-----

General Setup and Operation

Attach and Detach Module	1-3
Attach Module	1-3
Detach Module	1-4
Add Module While System is Powered On	1-5
Secure to Pole Using Optional Locking Pole Clamp	1-5
Start-Up	1-6
Power On System	1-6
Respond to Maintenance Reminder	1-7
Adjust Display Contrast	1-7
Select New Patient and Profile Options	1-8
Adjust Audio Volume	1-10
Lock/Unlock Tamper Resist	1-10
Power Off System	1-11
System Options	1-12
Display Contrast	1-12
Patient ID	1-12
Clinician ID	1-15
Power Down All Channels	1-16
Anesthesia Mode	1-17
Battery Runtime	1-20
System Configurations	1-20
Serial Numbers	1-22
Software Versions	1-23
Time of Day	1-24
Network Status	1-25
Wireless Connection	1-28
Data Set Status	1-29
Maintenance Due	1-30

General Information

Warnings and Cautions	1-31
General	1-31
Electromagnetic Compatibility	1-32
Features and Displays	1-33
Features and Definitions	1-33
Operating Features, Controls, Indicators	1-35
Displays	1-37
System Configurable Settings	1-38
Specifications and Symbols	1-39
Specifications	1-39
Symbols	1-40

Troubleshooting and Maintenance

General	1-43
Alarms, Errors, Messages	1-43
Definitions	1-43
Audio Characteristics	1-44
Alarms	1-45
Errors	1-45
Messages	1-46
Storage	1-46
Battery Care and Maintenance	1-47
Battery Type and Charging	1-47
Battery Charge	1-47
Battery Care	1-47
Battery Cautions and Disposal	1-48
Inspection Requirements	1-48

Introduction

This section of the DFU provides PC Unit (Model 8000) and Alaris® System instructions and information. It is used in conjunction with:

- PC Unit/Pump Module Technical Service Manual
- Product-specific sections of this DFU
- System Maintenance software (and its instructions) for Alaris® System check-in, maintenance, and wireless configuration

The PC Unit is the core of the Alaris® System and provides a common user interface for programming infusions and monitoring, which helps to reduce complexity at the point of care.

Alarms, Errors, Messages: See "Troubleshooting and Maintenance" for specific PC Unit alarms, errors and messages.

Contraindications: None known.

Electromagnetic Environment: See "Appendix" section of this DFU ("Regulations and Standards," "Compliance").

WARNING

Read all instructions, including those for the attached module(s) and applicable accessories, before using the Alaris® System.

CAUTION

Rx Only

THIS PAGE
INTENTIONALLY
LEFT BLANK

Attach and Detach Module

Modules can be attached to either side of the PC Unit or to either side of another module. The process to attach or detach is the same for either side, whether attaching/detaching to/from a PC Unit or another module.

An individual hospital/facility can choose to permanently attach modules. To remove permanently attached modules, contact qualified service personnel.

Attach Module

The Alaris® System is designed to operate a maximum of four infusion or monitoring modules. Modules added in excess of four are not recognized by the system. The Auto-ID Module can be included as a fifth module. A module can be attached in any position; however, when mounted on an IV pole, it is recommended that a balanced configuration be maintained.

Application of adhesive tape or other materials to the sides of the PC Unit and modules can prevent proper latching.

1. Position free module at a 45° angle, aligning IUI connectors.

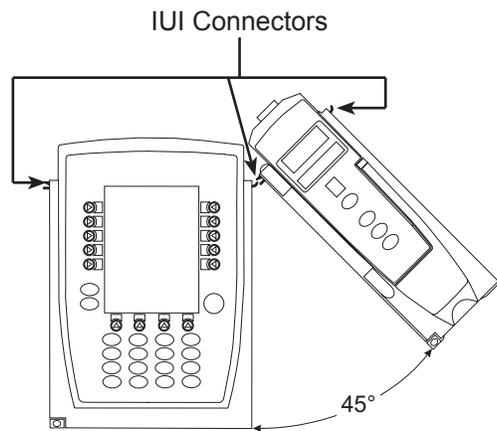

Attach and Detach Module (Continued)

Attach Module (Continued)

2. Rotate free module down against PC Unit or attached module, until release latch snaps in place.

WARNING

When properly secured/snapped, the **release latch** provides a very secure connection between modules. If not properly latched, a module can be dislodged during operation.

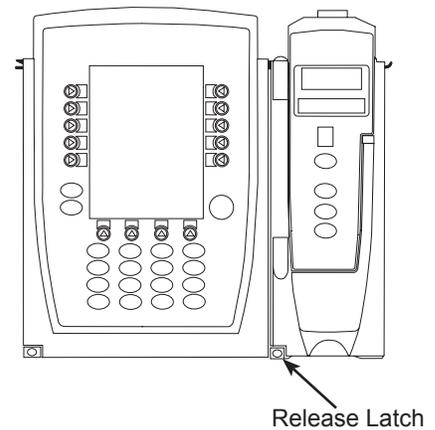

Detach Module

1. Ensure that module is powered off before detaching.
2. Push module release latch and then rotate module up and away from PC Unit or attached module (opposite to motion shown in "Attach Module" procedure) to disengage connectors.
 - Alaris® System reidentifies and shows appropriate module identification (A, B, C, or D), from left to right.
 - Appropriate module position(s) (A, B, or C) for remaining module(s) appear on Main Display.

Attach and Detach Module (Continued)

Add Module While System is Powered On

Add module as described in "Attach Module."

- System tests module, causing all LED segments and indicator lights of displays to illuminate briefly.
- Appropriate module identification display (A, B, C, or D) illuminates. Modules are always labeled left to right, so if a module is added to left of other modules, all modules are reidentified. Module reidentification does NOT interrupt or affect infusion or monitoring on active modules.
- Module positions (A, B, C, or D) appear on Main Display.
- If any of the following conditions are observed, affected module must be removed from use and inspected by qualified personnel:
 - LED segments are not illuminated on displays during power-on test.
 - Indicator lights do not illuminate.
 - Appropriate module identification does not appear.

Secure to Pole Using Optional Locking Pole Clamp

1. Attach PC Unit to pole.
2. Insert PCA Module syringe door key into key lock on pole clamp knob.
3. To lock PC Unit to pole, turn key in direction of arrow (clockwise).
Pole clamp knob spins in place, preventing PC Unit from being removed from pole.
4. To unlock PC Unit from pole, turn key in opposite direction of arrow (counter clockwise).
Pole clamp knob no longer spins in place, allowing PC Unit to be removed from pole.

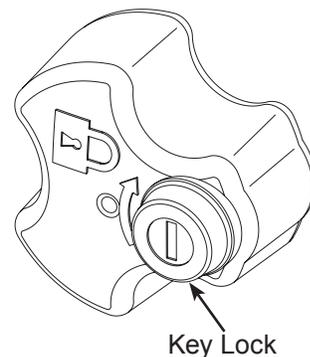

Start-Up

Power On System ^①

1. Connect PC Unit to an external AC power source.
2. Press **SYSTEM ON** key.
3. System self test begins:
 - Diagnostics test causes all LED display segments and Status Indicator lights of attached module(s) to illuminate briefly.
 - Power Indicator illuminates.
 - Appropriate module identification (A, B, C, or D) is displayed on attached module(s).
 - An Audio tone sounds.
 - If PM Reminder option is enabled and scheduled preventive maintenance is due, **MAINTENANCE REMINDER** screen appears.
 - At completion of system-on test, **New Patient?** screen appears.
 - If either of the following conditions are observed, PC Unit or affected attached module must be removed from use and inspected by qualified personnel:
 - System fails any part of self test.
 - Main Display does not appear backlit, appears irregular, or has evidence of a row of pixels not functioning properly.

NOTE:

- ① Previous infusion parameters are automatically cleared after 8 hours.

Start-Up (Continued)

Respond to Maintenance Reminder

If the Preventive Maintenance (PM) Reminder option is enabled and the PC Unit or an attached module is due for preventive maintenance, a **MAINTENANCE REMINDER** message appears at power up. If necessary, the reminder can be temporarily bypassed by pressing the **CONFIRM** soft key.

1. Notify the appropriate facility personnel when a **MAINTENANCE REMINDER** occurs and remove instrument requiring maintenance (see "Attach and Detach Module").
2. If Alaris® System was powered off to replace PC Unit, reinitiate start-up process.

OR

If an attached module (such as a Pump Module) was powered off and removed, **MAINTENANCE REMINDER** display reflects removal of that module. To continue start-up process, press **CONFIRM** soft key.

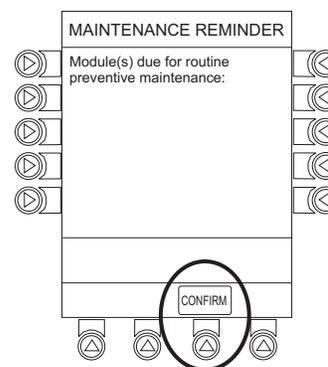
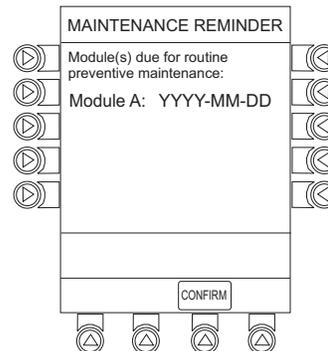

Adjust Display Contrast

1. Press **DISPLAY CONTRST** soft key.

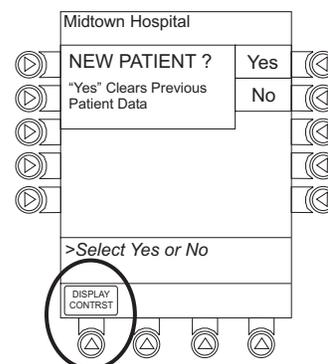

Start-Up (Continued)

Adjust Display Contrast (Continued)

- To adjust display for optimum viewing, use **Lighter/Darker** soft keys.
- To return to main screen, press **CONFIRM** soft key.

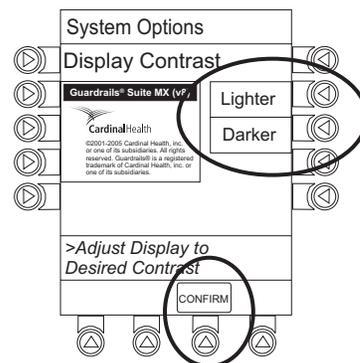

Select New Patient and Profile Options

The following procedures assume the Profiles feature is enabled.

- Select required **NEW PATIENT?** option.
 - To indicate programming is for a new patient and clear all stored patient parameters from memory, press **Yes** soft key.
 - To confirm programming is for same patient and retain all stored patient parameters, press **No** soft key.
 - Last used profile is displayed.
 - If Profiles feature is disabled, main menu appears.

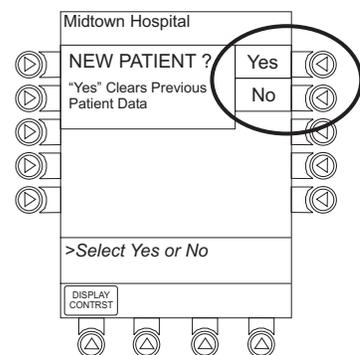

- Accept or change current profile:
 - To accept current profile, press **Yes** soft key.
Main screen appears.
 - To change profile, press **No** soft key and continue with next step.
Profile selection screen appears.

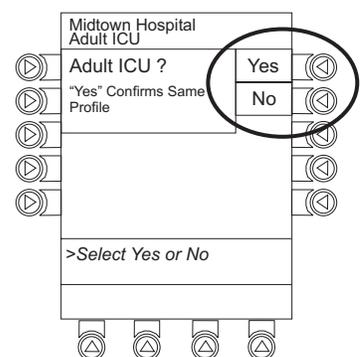

Start-Up (Continued)

Select New Patient and Profile Options (Continued)

- To select a profile, press corresponding left soft key.
To view additional choices, press **PAGE DOWN** soft key.
- To confirm profile selection, press **CONFIRM** soft key.
Main screen appears.

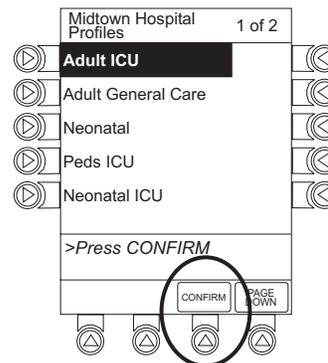

Patient ID Entry Feature

The option to enter and display a 16-character alphanumeric patient identifier is always available. The instrument can be configured to automatically display the **Patient ID Entry** screen during start-up or to provide access only through the **Systems Options** menu (see "System Options").

If **Yes** was selected to indicate programming for a new patient, perform one of following steps:

- If patient identifier is not required, press **CONFIRM** or **EXIT** soft key.
- To manually enter patient identifier, use numeric data entry keys and/or alpha speed keys.
 - An alphanumeric identifier, of up to 16 characters, can be entered.
 - Press soft key next to a letter group to list letters in that group. Press soft key next to an individual letter to enter that letter.
 - To access letter "Z" and special characters (hyphen, underscore, space), press **PAGE DOWN** soft key.
 - To clear an entire entry, press **CLEAR** key.
 - To back up a single character at a time, press **CANCEL** key.
- To scan bar code on patient identification band, see Auto-ID Module section of this DFU.

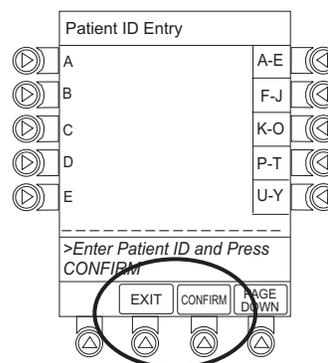

Start-Up (Continued)

Adjust Audio Volume

1. Press **AUDIO ADJUST** soft key.
2. To change volume to desired level, press either **Louder** or **Softer** soft key. To sample alarm loudness level, press **Test** soft key.
3. To return to PC Unit screen, press **MAIN SCREEN** soft key.
After 30 seconds without a key press, Main Display appears.

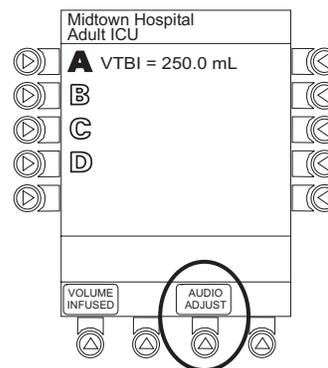

CAUTION

Setting the audio volume to the **lowest level** will lower all system alarms, including secondary alarms such as End of Infusion.

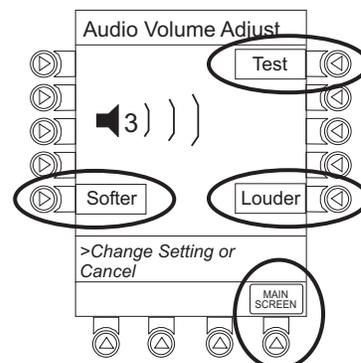

Lock/Unlock Tamper Resist

1. Initiate operation of applicable module.
2. Press and hold Tamper Resist Switch, on back of PC Unit, for 3 to 4 seconds (see "General Information," "Features and Displays," "Operating Features, Controls, Indicators").
 - An advisory tone (if **Key Click Audio** is enabled) and a three-second **PANEL LOCKED** prompt on Main Display confirm activation.

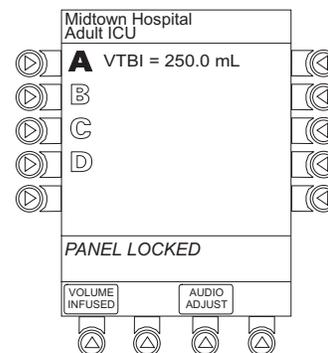

Start-Up (Continued)

Lock/Unlock Tamper Resist (Continued)

- When Tamper Resist is active, keypad panel is locked; however, clinician can:
 - Silence audio alarm.
 - View volume(s) infused.
 - View and test audio alarm setting.
 - View selected parameters on attached modules.

Any other key press results in a visual **PANEL LOCKED** prompt and, if **Key Click Audio** is enabled, an illegal key-press audio advisory.

3. To unlock keypad panel, press and hold Tamper Resist Switch for 3 to 4 seconds.

An advisory tone (if **Key Click Audio** is enabled) and a three-second **PANEL UNLOCKED** prompt on Main Display confirm activation.

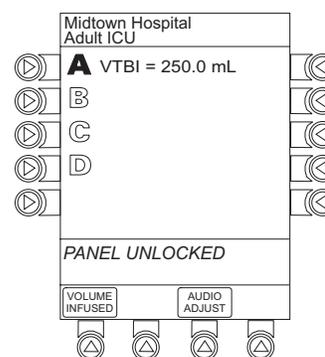

Power Off System

Press and hold **CHANNEL OFF** key until a beep is heard (approximately 1.5 seconds) and then release to initiate power down.

- During power off sequence, Main Display flashes **Powering Down**.
- To interrupt power down sequence, quickly press any key (except **SYSTEM ON**) on PC Unit.
- Once all attached modules are powered off, PC Unit automatically powers down.

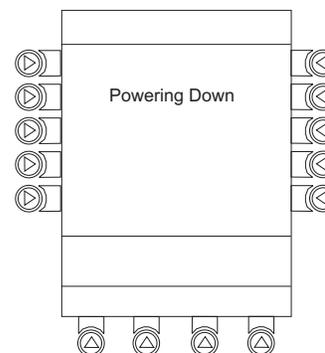

System Options

Display Contrast

1. Press **OPTIONS** key.

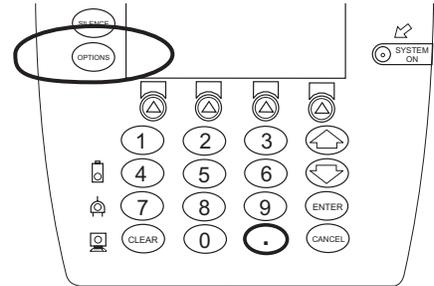

2. Press **Display Contrast** soft key.

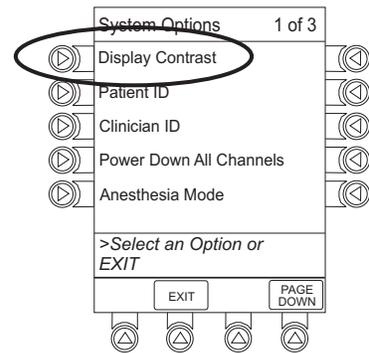

3. Adjust display and return to main screen (see "Start-Up," "Adjust Display Contrast" procedure).

Patient ID

Enter

1. Press **OPTIONS** key.
2. Press **Patient ID** soft key.

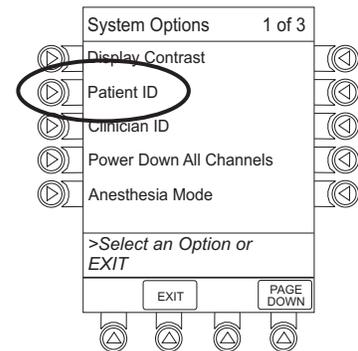

System Options (Continued)

Patient ID (Continued)

Enter (Continued)

3. Scan or manually enter patient identifier:
 - To manually enter patient identifier, use numeric data entry keys and/or alpha speed keys.
 - An alphanumeric identifier, of up to 16 characters, can be entered.
 - Press soft key next to a letter group to list letters in that group. Press soft key next to an individual letter to enter that letter.
 - To access letter "Z" and special characters (hyphen, underscore, space), press **PAGE DOWN** soft key.
 - To clear an entire entry, press **CLEAR** key.
 - To back up a single character at a time, press **CANCEL** key.
 - To scan bar code on patient identification band, see Auto-ID Module section of this DFU.
4. To verify correct entry, press **CONFIRM** soft key.

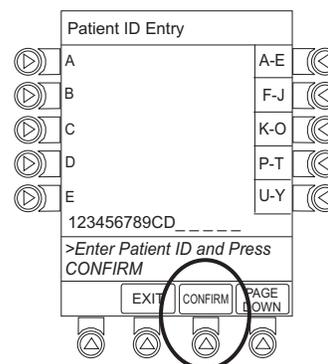

System Options (Continued)

Patient ID (Continued)

Modify

1. Press **OPTIONS** key.
2. Press **Patient ID** soft key.
3. To clear entire entry, press **CLEAR** key.

OR

To back up a single character at a time, press **CANCEL** key.

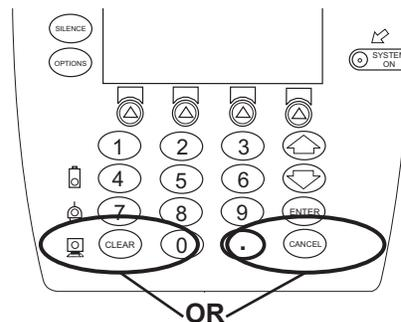

4. To enter modified patient identifier, use numeric data entry keys and/or alpha speed keys.
 - An alphanumeric identifier, of up to 16 characters, can be entered.
 - Press soft key next to a letter group to list letters in that group. Press soft key next to an individual letter to enter that letter.
 - To access letter "z" and special characters (hyphen, underscore, space), press **PAGE DOWN** soft key.

5. To verify correct entry, press **CONFIRM** soft key.

New **Patient ID Entry** verification screen appears.

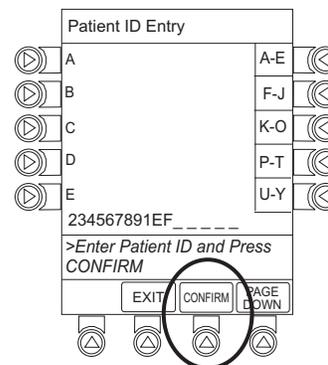

System Options (Continued)

Patient ID (Continued)

Modify (Continued)

- To accept modified Patient ID, press **Yes** soft key.

Main screen appears with new Patient ID.

OR

To retain original (old) Patient ID, press **No** soft key.

Main screen appears with old Patient ID.

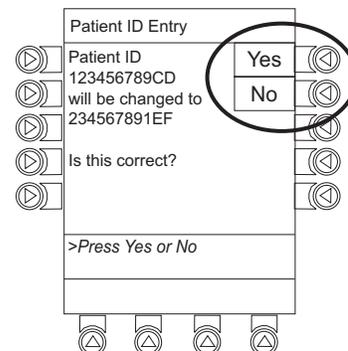

Clinician ID

- Press **OPTIONS** key.
- Press **Clinician ID** soft key.

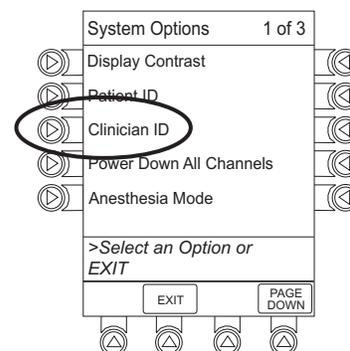

- Scan or manually enter clinician identifier:

To manually enter clinician identifier, use numeric data entry keys and/or alpha speed keys.

- An alphanumeric identifier, of up to 16 characters, can be entered.
- Press soft key next to a letter group to list letters in that group. Press soft key next to an individual letter to enter that letter.
- To access letter "Z" and special characters (hyphen, underscore, space), press **PAGE DOWN** soft key.
- To clear an entire entry, press **CLEAR** key.
- To back up a single character at a time, press **CANCEL** key.

System Options (Continued)

Clinician ID (Continued)

- To verify correct entry, press **CONFIRM** soft key.

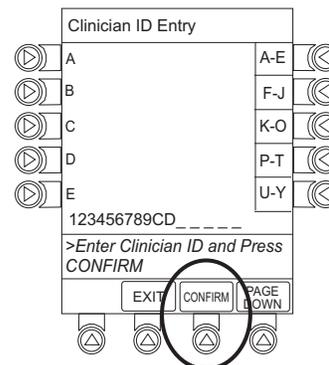

Power Down All Channels

- Press **OPTIONS** key.
- Press **Power Down All Channels** soft key.

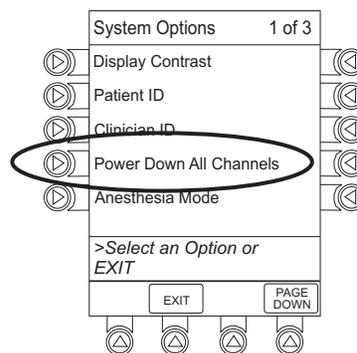

- Press **Yes** soft key.
- During power off sequence, Main Display flashes **POWERING DOWN**.

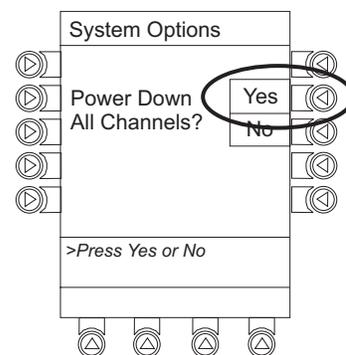

System Options (Continued)

Anesthesia Mode

When the Anesthesia Mode is enabled while a module is paused, the module remains in an indefinite pause until restarted.

When Anesthesia Mode is enabled:

- All limits are set to **Soft**.
- Dose checking mode is set to **Smart**.
- Key-press audio is turned off.
- Tamper Resist Mode (panel locked) is not available.
- Guardrails® drug list defaults to drugs designated by Editor Software as anesthesia only. All Guardrails® drugs in a profile can be viewed by pressing **ALL DRUGS** soft key.
- Bolus dose is automatically available for:
 - Guardrails® drugs that have bolus dose limits defined
 - generic drug calculation setup
- **Anesthesia Mode**, alternating with other required prompts, is displayed in prompt bar of Main Display.
- Callback audio for paused module is permanently silenced.
- Review of drug calculation setup page is omitted when restoring a stopped drug calculation.
- Clinical Advisories are not displayed.
- Auto-ID Module is not available.

CAUTION

When the Alaris® System is set up for use in Anesthesia Mode, it is important to **select the profile** that corresponds with the care area the patient will be taken to when the Anesthesia Mode is discontinued. This ensures that the Alaris® System will be in the correct profile following the use of the Anesthesia Mode.

Enable

1. Press **OPTIONS** key.
2. Press **Anesthesia Mode** soft key.

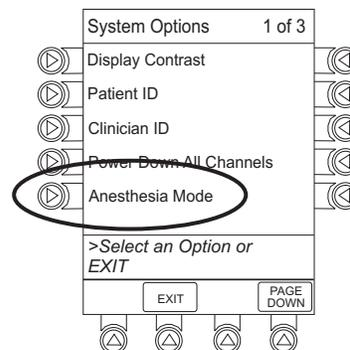

System Options (Continued)

Anesthesia Mode (Continued)

Enable (Continued)

3. Press **Enable** soft key.
4. Press **CONFIRM** soft key.

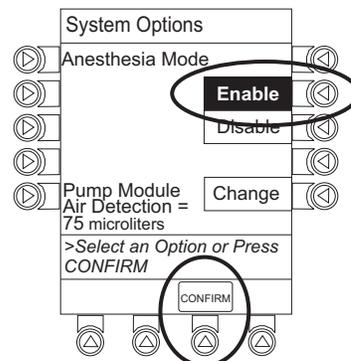

Disable

The Anesthesia Mode can be disabled, and normal operation resumed, using either of the following three methods:

- System Options menu.
- Disconnecting from AC power.
- Connecting to AC power.

From System Options Menu

1. Press **OPTIONS** key.
2. Press **Anesthesia Mode** soft key.
3. Press **Disable** soft key.
4. Press **CONFIRM** soft key.

Anesthesia Mode no longer appears on Main Display, indicating it has been disabled.

System Options (Continued)

Anesthesia Mode (Continued)

Disable (Continued)

Connect to AC Power

1. Connect system to AC power.
2. To continue using Anesthesia Mode, press **Yes** soft key.

OR

To discontinue Anesthesia Mode, press **No** soft key.

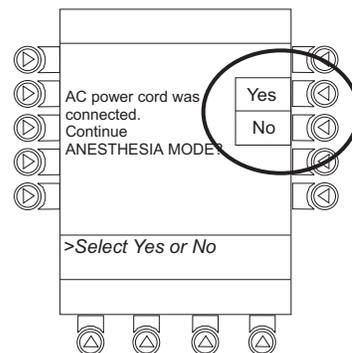

Disconnect from AC Power

1. Disconnect system from AC.
 - Anesthesia Mode is automatically disabled.
 - All currently running infusions continue.
 - A prompt appears as an alert that Anesthesia Mode has been discontinued.
2. Press **CONFIRM** soft key.

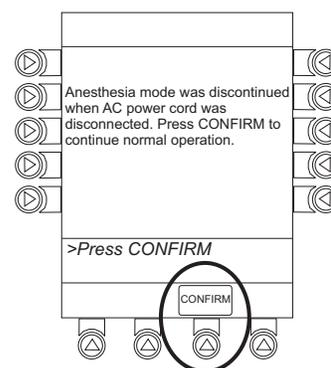

System Options (Continued)

Battery Runtime

1. Press **OPTIONS** key.
2. Press **PAGE DOWN** soft key.
3. Press **Battery Runtime** soft key.

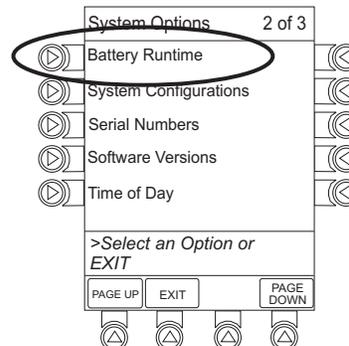

4. To return to main screen, press **CANCEL** key or **EXIT** soft key.

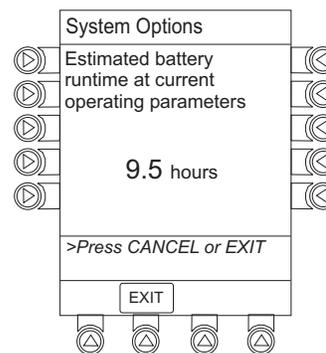

System Configurations

1. Press **OPTIONS** key.
2. Press **PAGE DOWN** soft key.
3. Press **System Configuration** soft key.

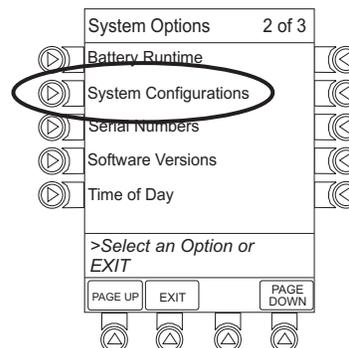

System Options (Continued)

System Configurations (Continued)

4. Press **PC Unit** soft key.

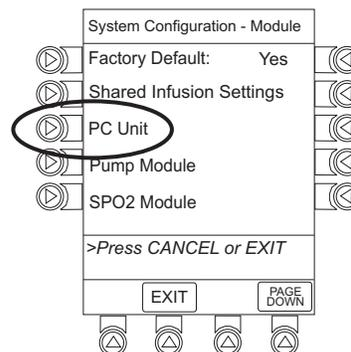

5. To review various system configuration settings, press **PAGE DOWN** and **PAGE UP** soft keys. ① ②

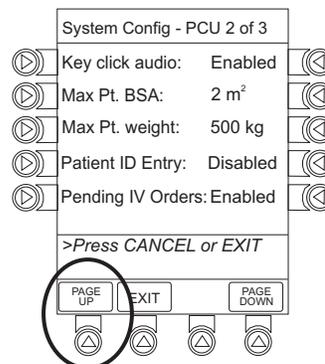
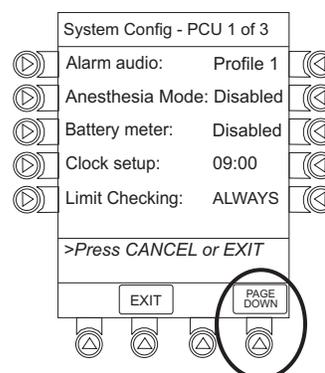

System Options (Continued)

System Configurations (Continued)

- To return to main screen, press **CANCEL** key or **EXIT** soft key.

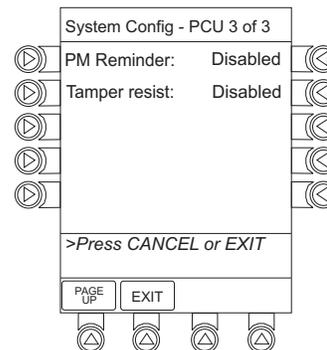

NOTES:

- The **Profiles** option is listed only if it is **disabled**.
- The **Limit Checking** (or **Dose Checking**), **Max Pt. BSA**, and **Pending IV orders** options are listed only if the **Profiles** option is **enabled** and a valid Data Set is loaded.

Serial Numbers

- Press **OPTIONS** key.
- Press **PAGE DOWN** soft key.
- Press **Serial Numbers** soft key.

Serial numbers for PC Unit and all attached modules display. ^①

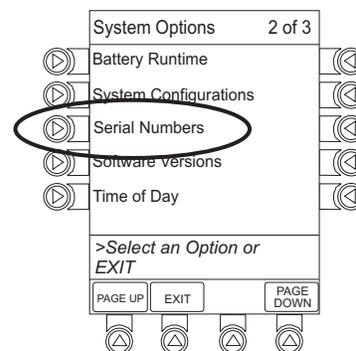

System Options (Continued)

Serial Numbers (Continued)

- To return to main screen, press **EXIT** soft key.

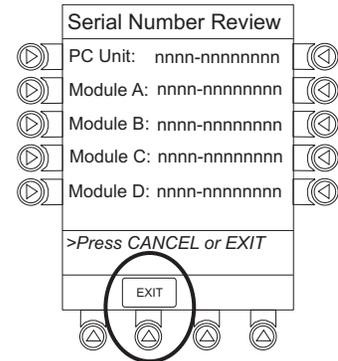

NOTE:

- "nnnn-nnnnnnnn" in the illustrated display represents a serial number.

Software Versions

- Press **OPTIONS** key.
- Press **PAGE DOWN** soft key.
- Press **Software Versions** soft key.

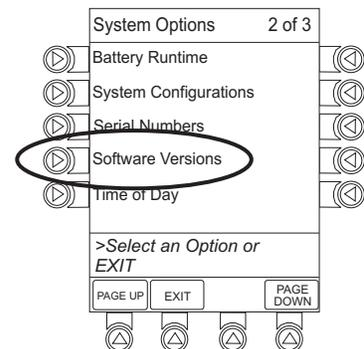

- To review software version information, press **View** soft key next to applicable module.

OR

To return to main screen, press **EXIT** soft key.

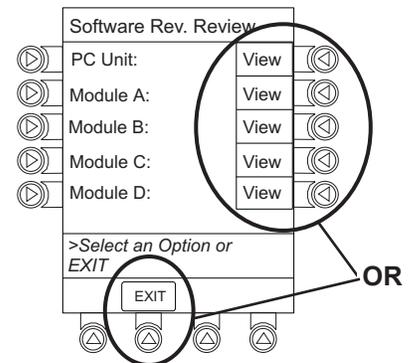

System Options (Continued)

Software Versions (Continued)

- To return to previous screen, press **EXIT** soft key. ①

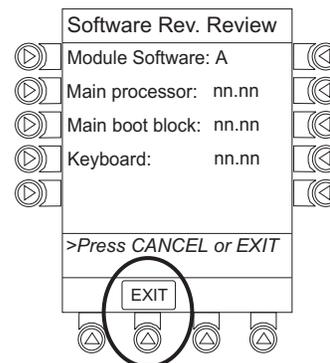

NOTE:

- ① "nn.nn" in the illustrated display represents a software version.

Time of Day ①

- Press **OPTIONS** key.
- Press **PAGE DOWN** soft key.
- Press **Time of Day** soft key.

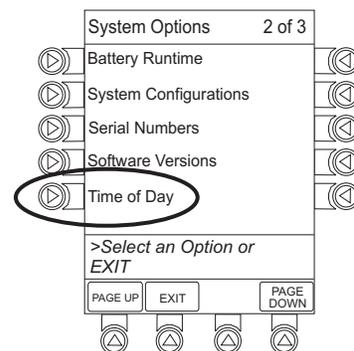

- If time is correct, press **CONFIRM** soft key.

OR

To change time, press **Change Time** soft key.

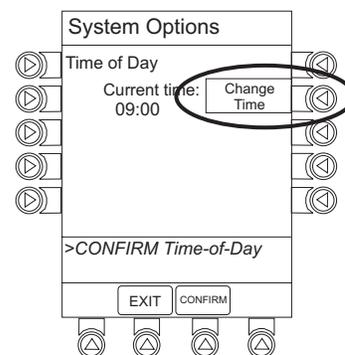

System Options (Continued)

Time of Day (Continued) ①

5. Enter current Time of Day.

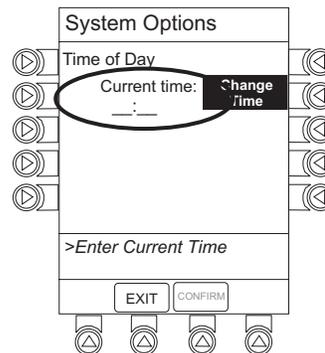

6. Press **CONFIRM** soft key.

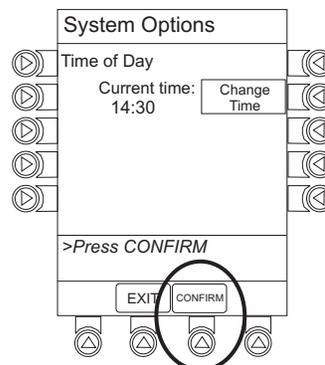

NOTE:

- ① The format is a 24-hour clock (military time).

Network Status

This option is available only when the Communications Interface Board Accessory is installed and the PC Unit has been flashed to support wireless communications with Alaris® Server or Mobile Systems Manager. The displayed status updates immediately when a status change takes place.

1. Press **OPTIONS** key.
2. Press **PAGE DOWN** soft key two times.

System Options (Continued)

Network Status (Continued)

- To view network status and wireless status information, press **Network Status** soft key.

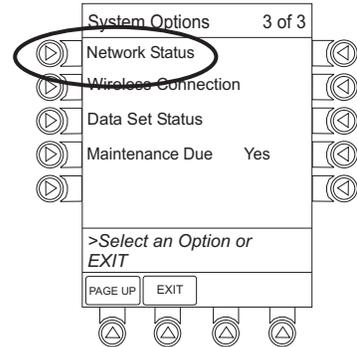

- Enter password (refer to v9.5 or later System Maintenance software instructions) and press **CONFIRM** soft key.

- Information based on a wireless status of **DISABLED**, **DISASSOCIATED**, **ASSOCIATING**, **ASSOCIATED**, or **AUTHENTICATING** is displayed.
- If wireless status is **ASSOCIATED**, the following information is displayed:
 - Wireless connectivity: **SSID**, **Channel**, **Authentication**, and **Encryption** types being used; **BSSID**—MAC address of access point that system is connected to; **Speed**—transfer rate up to 54 Mbps for 802.11a/g and 11 Mbps for 802.11b.
 - Link Quality**—a minimum of 20% recommended for good wireless connectivity.
 - Signal Strength**—greater than 20% recommended for good wireless connectivity.

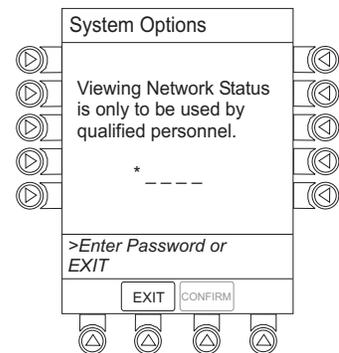

- To view network connectivity information, press **NET STATUS** soft key.

- A status of **DISABLED**, **DISCONNECTED**, **CONFIGURING**, or **CONNECTED** is displayed. A status of **INVALID CONFIG** is also displayed on a v9.5 and later PC Unit.
- If status is **CONNECTED**:
 - PC Unit is connected to wireless network.
 - Profile** being used for v9.5 and later PC Unit is displayed.

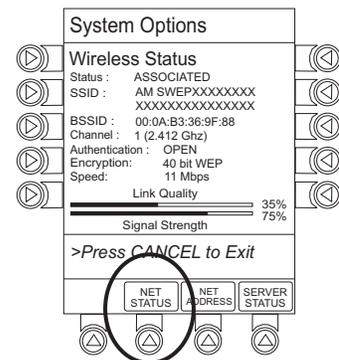

System Options (Continued)

Network Status (Continued)

- To view network address information, press **NET ADDRESS** soft key.
 - MAC Address** of wireless RF card attached to PC Unit is displayed.
 - If **DHCP** displays **No**, PC Unit is set to use a Static IP address.
 - When PC Unit is connected to wireless network, **IP Address**, **Subnet Mask**, **Gateway**, and **DNS** information is displayed.

Pre-v9.5 PC Unit:

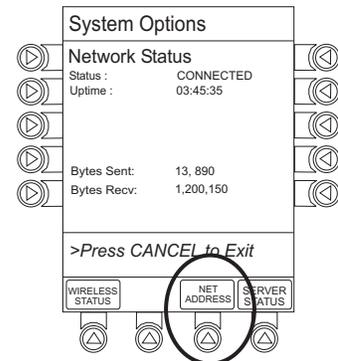

v9.5 and later PC Unit:

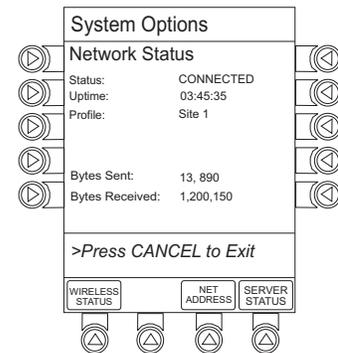

- To view server connectivity information, press **SERVER STATUS** soft key.

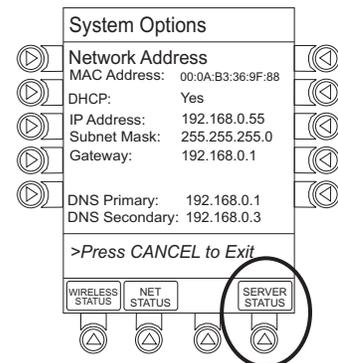

System Options (Continued)

Network Status (Continued)

- Pre-v9.5 PC Unit: Information based on a status of **DISABLED**, **SEARCHING**, **VERIFYING**, **CONNECTING**, or **CONNECTED** is displayed.
- v9.5 and later PC Unit: Information based on a status of **DISABLED**, **DISCONNECTED**, **CONNECTING**, or **CONNECTED** is displayed.
- If status is **CONNECTED**, PC Unit is connected to Alaris® Server and the following information is displayed:
 - **Uptime**—length of time PC Unit has been connected.
 - **Server Address**—IP Address of Alaris® Server.
 - **TCP Port** being used to establish connection.
 - **Encryption** type (AES 128-bit) used to encode data on payload and protect patient-sensitive information sent through wireless network.
 - **Bytes Sent**—cumulative total of data sent.
 - **Bytes Received**—cumulative total of data received.
 - **Server Name** when v9.5 and later PC Unit is connected— first 20 characters of fully-qualified domain name of Alaris® Server.

Pre-v9.5 PC Unit:

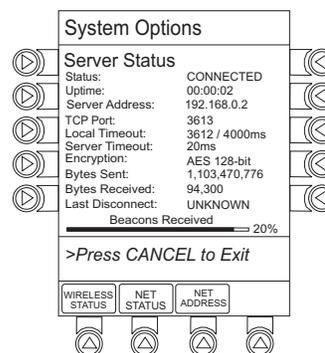

v9.5 and later PC Unit:

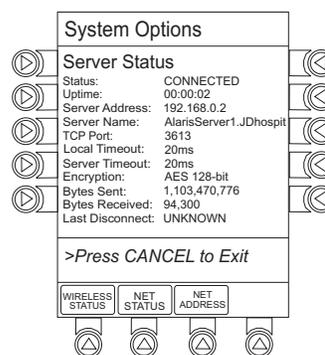

Wireless Connection

This option is available only when the Communications Interface Board Accessory is installed and the PC Unit has been flashed to support wireless communications with Alaris® Server or Mobile Systems Manager.

1. Press **OPTIONS** key.
2. Press **PAGE DOWN** soft key two times.
3. Press **Wireless Connection** soft key.

v9.5 or later PC Unit: If **Wireless Connection** soft key is inactive (grayed out), System Maintenance software was used to disable wireless connection. To enable wireless connection, use v9.5 System Maintenance software.

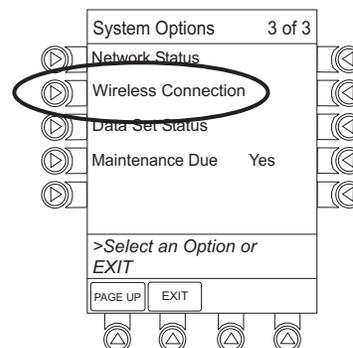

System Options (Continued)

Wireless Connection (Continued)

- Wireless connection can be disabled or enabled:
 - To disable wireless connection, press **Disable** soft key.
 - If wireless connection is disabled, it remains disabled until PC Unit is powered off. Setting defaults to **Enable** when PC Unit is powered back on.
 - v9.5 System Maintenance software instructions also includes a procedure on how to disable a wireless RF card on a v9.0 or later PC Unit being used in a non-wireless environment. Wireless connection remains disabled until System Maintenance software is used to enable it.
 - To enable wireless connection, press **Enable** soft key.

Pre-v9.5 PC Unit: View **Network Status** after pressing **Enable** soft key. If a **Status** of **DISABLED** is identified, System Maintenance software was used to disable wireless connection. Use v9.5 System Maintenance software to enable wireless connection.

WARNING

To comply with FAA regulations and prevent potential interference with aircraft communications, **disable wireless communication** when the Alaris® System is used in an aircraft.

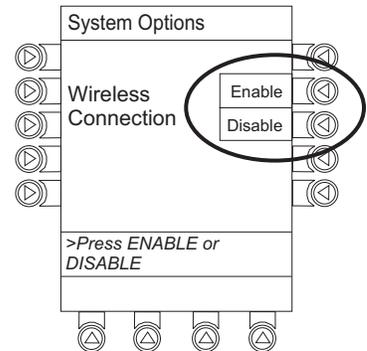

Data Set Status

- Press **OPTIONS** key.
- Press **PAGE DOWN** soft key two times.
- To view Data Set status, press **Data Set Status** soft key.

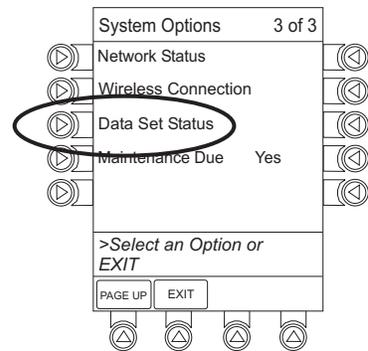

System Options (Continued)

Data Set Status (Continued)

A status of **Current**, **Pending**, **Transferring**, or **Not Activated** is displayed.

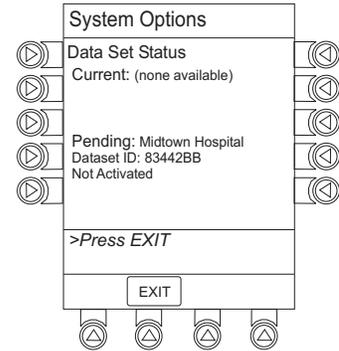

Maintenance Due

1. Press **OPTIONS** key.
2. Press **PAGE DOWN** soft key two times.
3. Press **Maintenance Due** soft key.

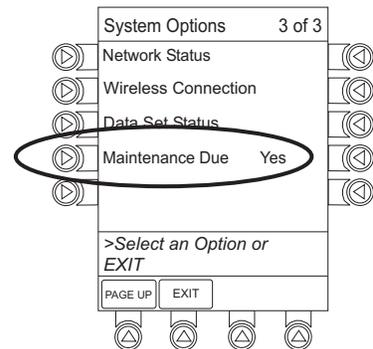

4. To return to main screen, press **EXIT** soft key. ^①

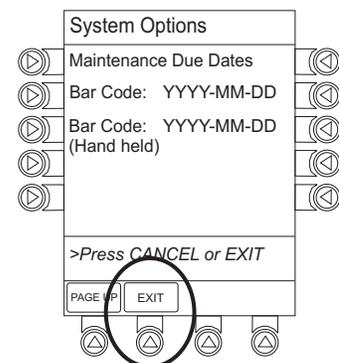
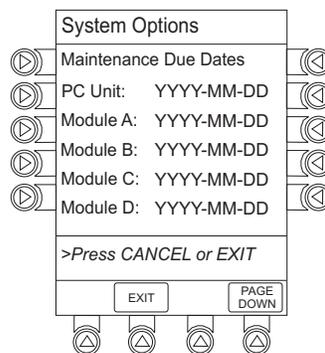

NOTE:

- ^① **PAGE DOWN** soft key appears only if an Auto-ID Module is attached.

Warnings and Cautions

◀ DANGER ▶

Explosion risk if used in the presence of flammable anesthetic agents or gasses.

General

WARNINGS

- Assess patient's condition **before silencing an alarm**. Do not silence alarm if patient safety might be compromised.
- Before each use, **verify that the alarm limits** are appropriate for the patient.
- The Alaris® System performs a **self check during power up**. The PC Unit should beep, no errors should occur, and if a module is connected, all LED segments should flash. If the Alaris® System fails the self check, remove the failing PC Unit or module from use.
- When properly secured/snapped, the **release latch** provides a very secure connection between modules. If not properly latched, a module can be dislodged during operation.
- Disconnect from main (AC) and battery power when performing **maintenance**.
- Electrical shock hazard. **Do not open case**. Refer to qualified service personnel.
- Due to the **intermittent nature of a wireless environment**, some data can be lost if a connection cannot be established or is lost. The Alaris® Server and wireless network card are designed to minimize these incidents but cannot eliminate them.
- To comply with FAA regulations and prevent potential interference with aircraft communications, **disable wireless communication** when the Alaris® System is used in an aircraft (see "System Options," "Network Status").
- The Alaris® System is not intended to replace **supervision by medical personnel**. The user must become thoroughly familiar with the Alaris® System features, operation and accessories prior to use.

Warnings and Cautions (Continued)

General (Continued)

CAUTIONS

- Always use a grounded, **three-wire receptacle**. Where the integrity of the protective earth grounding system is in doubt, operate on internal battery.
- **Hyperbaric Chamber Operation:**
 - The Alaris® System is not certified for use in oxygen-enriched environments.
 - The Alaris® System, with the exclusion of the EtCO₂ Module, has been verified to operate with no malfunction alarms due to the hyperbaric chamber environment or unintentional key presses when used in a hyperbaric chamber.
 - The healthcare facility's hyperbaric safety director is responsible for all equipment used in the hyperbaric chamber environment.
- Should an instrument or accessory be **dropped or severely jarred**, it should be immediately taken out of use and inspected by qualified service personnel to ensure its proper function prior to reuse.
- If an instrument appears **damaged**, contact CareFusion for authorization to return it for repair.

Electromagnetic Compatibility

WARNINGS

- Do not use the Alaris® System near Magnetic Resonance Imaging (**MRI**), including Stereotaxis technology.
- Do not use the Alaris® System near **Therapeutic Radiation** equipment, such as Linear Accelerators.
- Use of any **accessory, transducer or cable** other than those specified can result in increased emissions or decreased Alaris® System immunity.
- Do not use an **RF device** within 7.8 inches/20 cm of the Radio Card on the PC Unit. FCC approval of the Radio Card excludes co-location with any other transmitter.
- Per FCC regulations, **maintain a distance** of at least 7.8 inches/20 cm between the Radio Card on the PC Unit and a human body.

Warnings and Cautions (Continued)

Electromagnetic Compatibility (Continued)

CAUTIONS

- The Alaris® System should not be used **adjacent to or stacked with other equipment**. If adjacent or stacked use is necessary, monitor the Alaris® System to verify that it is operating normally in that setup.
- **Portable and mobile RF communications** can affect medical electrical equipment.
- **Interconnected data communications systems** must be certified to IEC 60950 (data processing equipment) or IEC 60601–1 (electromedical equipment).
- The Alaris® System is intended for use by healthcare professionals only. This is a CISPR 11 Class B Group 1 medical system. In a domestic environment, this system **can cause radio interference**. Reorienting, relocating or shielding the system, or filtering the connection to the public mains network, are examples of steps that can be taken to reduce or eliminate interference.
- Medical electrical equipment **needs special precautions regarding EMC** and needs to be installed and used according to the EMC information provided in the "Appendix" section of this DFU (see "Regulations and Standards," "Compliance").
- **Nurse call systems** must be certified to UL 1069 (hospital signaling and nurse call equipment) or comply with the requirements specified in IEC 60601–1.

Features and Displays

Features and Definitions

See the product-specific section of this DFU that applies to the attached module(s) for features and definitions specific to that module.

Feature	Definition
Clinician ID	An optional alphanumeric 16-character clinician identifier that can be entered and displayed.

Features and Displays (Continued)

Features and Definitions (Continued)

Feature	Definition
Data Set	Created using Editor Software authoring tool and then transferred to PC Unit. A Data Set reflects facility's best-practice guidelines for IV Drug administration and includes: Profile Drug Libraries, Clinical Advisories, instrument configurations, and Channel Label Libraries.
Guardrails® Suite MX	Designed to help prevent programming errors by: <ul style="list-style-type: none"> • Customizing device configurable settings to meet need of selected hospital/facility area/unit (profile). • Comparing user programming with hospital-defined best-practice guidelines. • Providing a visual and audio prompt if an out-of-limits entry is made.
Patient ID	An optional alphanumeric 16-character patient identifier that can be entered and displayed <ul style="list-style-type: none"> • When enabled, ID entry defaults to Startup screen. • When disabled, ID entry is only accessible from System Options screen.
Profile	A unique set of system configuration settings and best-practice guidelines for a specific patient population or patient type, and can consist of following components: <ul style="list-style-type: none"> • Instrument configuration settings. • A Drug Library, which includes drug names, standard concentrations, dosing units, duration limits, and optional associated Clinical Advisories for both continuous and bolus dose infusion. • An IV Fluid library, an optional library consisting of IV Fluids (for example, TPN) and limits around rate of delivery. • A Channel Label Library with text (alphanumeric) labels, which allows identification (on modules) that can be used to indicate route of delivery (for example, epidural). <p>Profile settings are established by the facility's own multi-disciplinary team prior to system implementation. Profile parameters are used to create a Data Set, which is then transferred to the PC Unit.</p>
System Configuration	Allows system settings to be customized. If Profiles feature is enabled, system settings defined for selected profile are automatically activated.
Tamper Resist	Provides a quick one-touch lockout of front panel keypad.

Features and Displays (Continued)

Operating Features, Controls, Indicators

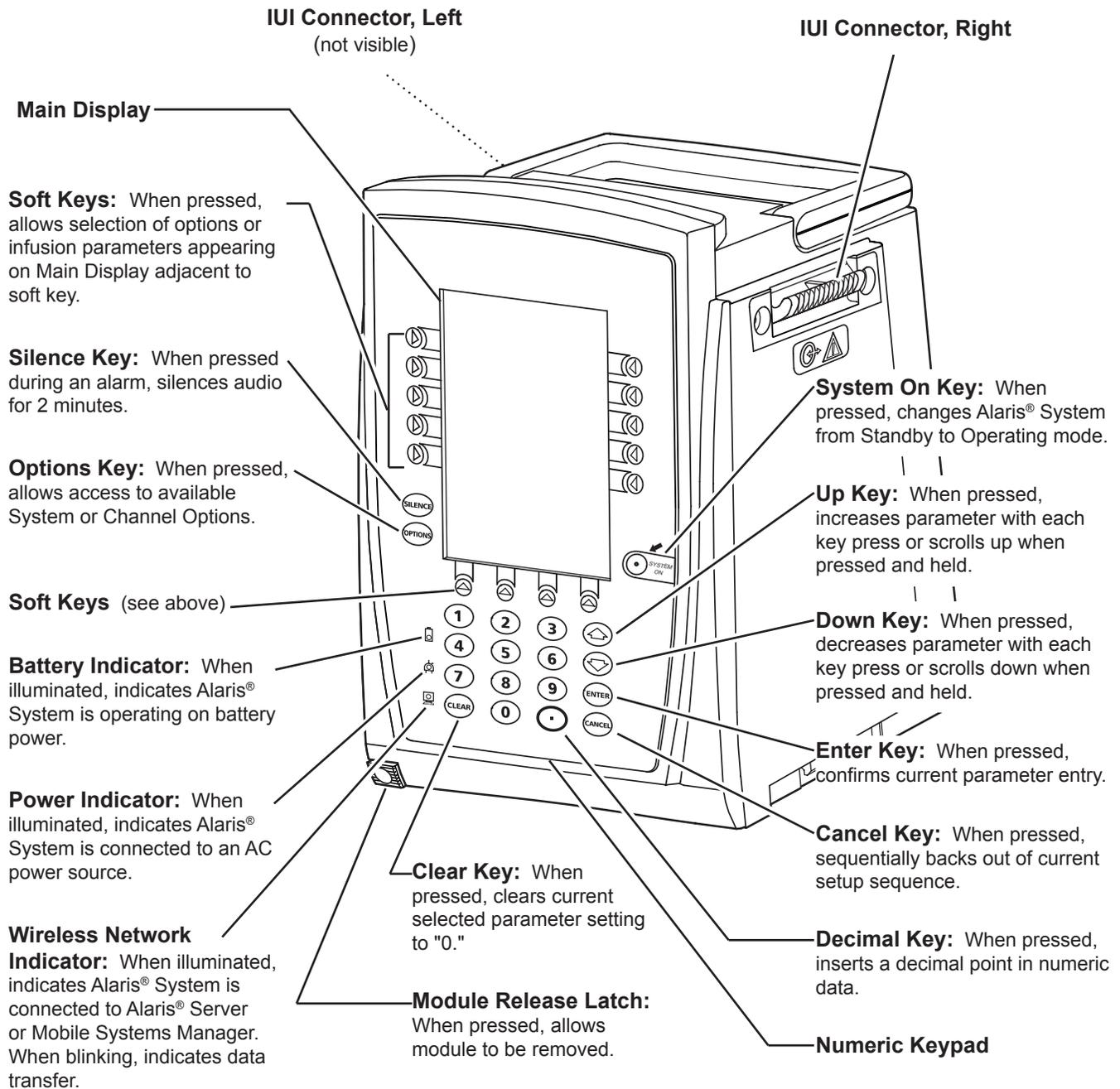

Features and Displays (Continued)

Operating Features, Controls, Indicators (Continued)

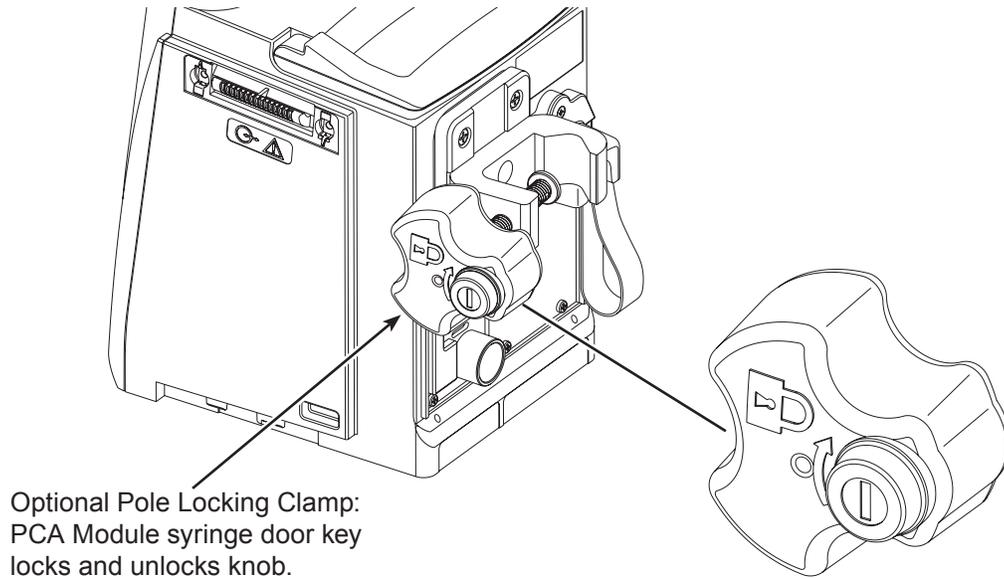
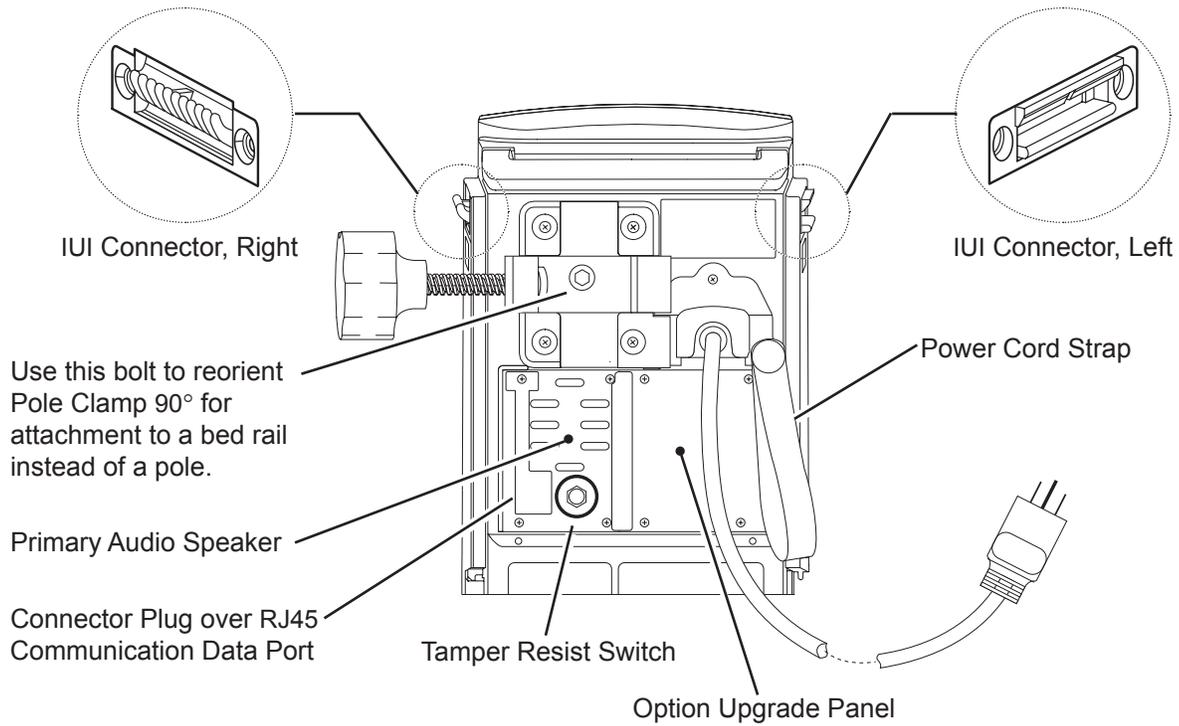

Features and Displays (Continued)

Displays

The displays illustrated throughout this document are for illustration purposes only. The display content varies, depending on configuration settings, hospital-defined Data Set uploaded using the Guardrails® Suite MX, and many other variables.

Main Display

Title Bar

Module Status

- A solid letter display indicates module is operating.
- An outlined letter display indicates module is attached and ready for use.

Soft Keys

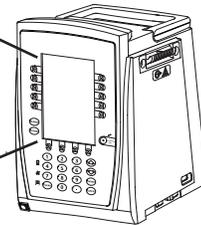
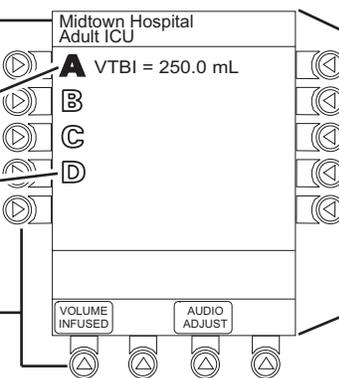

Module Selected Indicator

"Inactive" Soft Key

Nonhighlighted indicates a nonselected soft key.

"Active" Soft Key

Highlighted indicates a selected soft key.

Prompt Bar

Look here for user prompts.

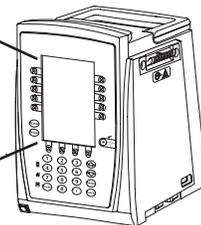
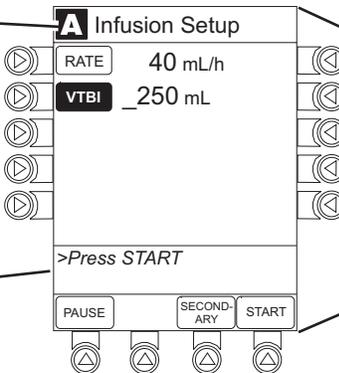

System Configurable Settings

If the configuration settings need to be changed from the **Factory default** settings, refer to the applicable Technical Service Manual or contact CareFusion Technical Support, for technical, troubleshooting, and preventive maintenance information.

With the Profiles feature enabled, the settings are configured independently for each profile. A hospital-defined, best-practice Data Set must be uploaded to enable the Profiles feature. Date and Time is a system setting and is the same in all profiles.

Feature	Default Setting	Options
Alarm Audio	Profile 1	Profile 1, 2, or 3
Anesthesia Mode	Disabled	Enabled - Disabled
Battery Meter	Disabled	Enabled - Disabled
Clock Setup (Date and Time)	Not Applicable	Set date and time
Dose Checking	Always	Always, Smart
Key Click Audio	Enabled	Enabled - Disabled
Max Patient Weight	500 kg	0.1 - 500 kg
Patient ID Entry	Disabled	Enabled - Disabled
PM Reminder (Preventive Maintenance)	Enabled	Enabled - Disabled
Profiles	Disabled	Enabled - Disabled
Tamper Resist	Disabled	Enabled - Disabled

Specifications and Symbols

Specifications

Battery Operation: Battery run time is a function of the number of modules attached and module activity. With a new, fully charged battery, the system operates as follows before a "BATTERY DISCHARGED" message occurs:

- 6 hours with one Pump Module infusing at 25 mL/h
- 6 hours with one Pump Module infusing at 25 mL/h and one Auto-ID Module
- 3 hours with four Pump Modules infusing at 25 mL/h
- 3 hours with four Pump Modules infusing at 25 mL/h and one Auto-ID Module
- 4.5 hours with one active SpO₂ Module
- 6 hours with one Syringe Module or PCA Module infusing at 5 mL/h
- 3 hours with four Syringe Modules, or one PCA Module and three Syringe Modules, infusing at 5 mL/h
- 4 hours with one active EtCO₂ Module

Communication Data Port: RS-232 with an RJ45 connector.

Dimensions: 6.9" W x 8.8" H x 9" D (including pole clamp)

Electric Classification: Class 1, Internally Powered Equipment

Electronic Memory: System configuration parameters stored in volatile memory are retained for at least six months by internal backup lithium battery. Module-specific parameters are stored for 8 hours when system is turned off. After 8 hours of continuous off-time, or if a module is detached, module-specific trend data (if applicable) and module-specific operating parameters are automatically purged. If a PCA, SpO₂ or EtCO₂ Module is detached and replaced with another PCA, SpO₂, or EtCO₂ Module, its module-specific trend data is purged.

Environmental Conditions:

	Operating	Storage/Transport
Atmospheric Pressure	525 - 4560 mmHg (700 - 6080 hPa)	375 - 760 mmHg (500 - 1013 hPa)
Relative Humidity (Avoid prolonged exposure to relative humidity >85%)	20 - 90% Noncondensing	5 - 85% Noncondensing
Temperature Range	41 - 104°F (5 - 40°C)	-4 - 140°F (-20 - 60°C)

Equipment Orientation: To ensure proper operation, Alaris® System must remain in an upright position.

Fluid Ingress Protection: IPX1, Drip Proof

Mode of Operation: Continuous

Power Requirements: 100 - 240V ~, 50/60 Hz, 150 VA MAX

Shock Protection: Type CF, Defibrillator Proof

Weight: 7.2 lbs

Specifications and Symbols (Continued)

Symbols

See the product-specific section of this DFU that applies to the attached module(s) for symbols specific to that module.

Symbol	Meaning
	Alternating Current: Indicates device should be attached to alternating current source, 50/60 Hz only.
	Caution: Refer to accompanying documentation.
	Canadian and U.S. Certification Mark: Products bearing this mark have been tested and certified in accordance with applicable U.S. and Canadian electrical safety and performance standards.
	Communications connector for RS-232 attachment.
	Consult operating instructions.
	Type CF defibrillation-proof equipment.
	Electrostatic discharge (ESD).
	Fuse Replacement: Replace fuse only with same type and rating.
IPX1	Protection against fluid ingress: Drip Proof.
	IUI Connector: Inter-Unit Interface connector used to establish power and communications between PC Unit and attached modules.
	Manufacturing Date: Number adjacent to symbol indicates month and year of manufacture.
	Potential Equalization Conductor (if so equipped). Note: If integrity of PEC or Hospital Earth System is in question, operate instrument using internal battery power.
	Radio frequency (RF) transmission.

Specifications and Symbols (Continued)

Symbols (Continued)

Symbol	Meaning
Rx Only	Caution: Federal (U.S.A.) law restricts this device to sale by or on order of a physician.
	Tamper Resist activate/deactivate switch.

THIS PAGE
INTENTIONALLY
LEFT BLANK

Troubleshooting and Maintenance

General

Troubleshooting and maintenance are intended to be performed only by qualified personnel, using the Alaris® System Technical Service Manuals and the System Maintenance software. The Service Manuals and System Maintenance software are available from CareFusion. The Service Manuals include routine service schedules, interconnect diagrams, component parts lists and descriptions, test procedures, and other technical information to assist qualified service personnel in repair and maintenance of the instrument's repairable components. The System Maintenance software is used to perform a new instrument check-in, preventive maintenance tests, calibration checks, calibration, and other maintenance functions.

Alarms, Errors, Messages

To enhance safety and ease of operation, the Alaris® System provides a full range of audio and visual alarms, errors, and messages.

Operating the system near equipment which radiates high-energy radio frequencies (such as electrosurgical/cauterizing equipment, portable radios, cellular telephones) might cause false alarm conditions. If this happens, reposition the Alaris® System away from the source of interference or turn off the system and manually regulate the flow with the clamp and/or monitor the vital parameters using an appropriate clinical alternative.

Definitions

See the product-specific section of this DFU that applies to the attached module(s) for alarm, error, and message definitions specific to that module.

Advisory/Message	A sequence of audio and/or visual signals indicating system operating status.
Alarm	An audio and visual signal that a potentially unsafe condition is present. Immediate action is required.
Alarm Silence	Alarms can be silenced for up to 120 seconds by pressing SILENCE key.

Alarms, Errors, Messages (Continued)

Definitions (Continued)

Error	An audio and/or visual signal that a failure has been detected. Immediate action is required.
Maintenance Reminder	A visual message that, when enabled, appears at startup when scheduled preventive maintenance is due/overdue for component of Alaris® System (PC Unit or attached module).
Prompt	An audio signal and/or a visual message appearing on bottom line of Main Display or in Message Display. Audio signal can be silenced for 12 seconds by pressing SILENCE key.

Audio Characteristics

The Alaris® System provides various types of alert information. See the product-specific section of this DFU that applies to the attached module(s) for audio characteristics specific to that module.

Type	Sound	Note
Advisory/Message	One short beep every 2 seconds.	Variable volume; can be silenced for 2 minutes.
Alarm	Choice of three alarm audio profiles, selectable in System Configuration.	Variable volume; can be silenced for 2 minutes.
Error (Hardware Detected)	Pairs of long beeps.	Fixed maximum decibel volume; cannot be silenced.
Error (Software Detected)	Pairs of long beeps.	Fixed maximum decibel volume; can be silenced for 2 minutes.
Illegal Key Press	Two short beeps.	Variable volume; cannot be silenced.
Key Click	One short beep.	Fixed minimum volume; can be silenced and disabled in System Configuration.
Prompt	One short beep every 2 seconds.	Variable volume; can be silenced.

Alarms, Errors, Messages (Continued)

Alarms

Alarm	Meaning	Response
Battery Discharged	Operation of all modules stopped due to insufficient battery charge.	Connect AC power cord to power source (alarm silenced). To continue operation of paused modules, press RESTART key on affected module.
Channel Disconnected	Module disconnected while in operation or have a communication problem.	To silence alarm and clear message from screen, press CONFIRM soft key. Reattach module, if needed, ensuring it is securely "clicked" into place at Module Release Latch. If alarm is still present, replace module.
Very Low Battery <5 minutes to system shutdown	Battery has 5 minutes or less of power at current power consumption rate before operation stops.	Connect AC power cord to power source (alarm silenced).

Errors

Error	Meaning	Response
Audio System Error	Main speaker failure.	Visually check alarm status to determine whether or not an operational alarm also needs to be addressed (red Alarm Status Indicator lit). Replace PC Unit.
Channel Error	Error detected. Operation stops on affected module.	To silence alarm and continue operation of unaffected modules, press CONFIRM soft key. Replace module.
Defective Battery	Defective battery.	To continue temporary operation, press SILENCE key. Replace PC Unit.
Hardware Detected Error	Error detected on PC Unit. Operation stops on all modules.	Replace PC Unit.
Missing Battery	Battery not present or not connected.	To continue temporary operation, press SILENCE key. Replace PC Unit.

Alarms, Errors, Messages (Continued)

Errors (Continued)

Error	Meaning	Response
Power Supply Error	Power supply system malfunction.	Disconnect AC power immediately. To continue operation under battery power, press SILENCE key. Replace PC Unit.
System Error	Error detected on PC Unit. Operation continues on all attached modules.	To continue temporary operation, press SILENCE key. Replace PC Unit.

Messages

Message	Meaning	Response
Battery Run Time = X.X hours	AC power cord is disconnected from power source. Approximate remaining battery run time under current power consumption rate is displayed.	Connect AC power cord to power source as soon as possible.
Low Battery	Low battery threshold sensed; remaining battery run time is limited.	Connect to power source (alarm silenced).
Panel Locked	Tamper Resist feature is active and key was pressed.	If appropriate, deactivate Tamper Resist feature using Tamper Resist Control on back of PC Unit.
Panel Unlocked	Tamper Resist feature deactivated.	None.
Powering Down	Last module powering off. System shuts off in indicated number of seconds.	Press any key, except SYSTEM ON key, to cancel power down sequence.
Replace Battery	Occurs at System On. Battery has less than 50% of original capacity.	To continue normal operation with reduced battery capacity, press CONFIRM soft key. Replace PC Unit.

Storage

Plug the PC Unit into an AC outlet during storage to ensure a fully charged battery. The AC indicator light () is on when the PC Unit is plugged in.

Battery Care and Maintenance

Battery Type and Charging

The PC Unit is equipped with a 12 volt, 4000 mAh nickel metal hydride battery. The battery is charging whenever the instrument is plugged into an AC receptacle. The life expectancy of the battery is dependent on the amount of use, the depth of discharge, and the state of the charge that is maintained. Generally, the battery has the longest life if the instrument is plugged in and battery use is infrequent. Frequent use of battery power and insufficient battery charge cycles significantly decrease the life of the battery.

The quality of the battery is also a significant factor in determining battery life and runtime. The battery cannot be repaired and should not be opened. Replace the battery with the same type, size and voltage rating. Use only CareFusion batteries and accessories.

Batteries should be charged in a room with a temperature between 50 - 80.6°F (10 - 27°C) to minimize charge time and maximize battery life.

Battery Charge

The PC Unit is shipped with the battery in a discharged condition.

Before the PC Unit is released for use, it should be plugged into a hospital grade AC outlet and the battery charged for at least 8 hours. This ensures proper battery operation when the Alaris® System is first set up for patient use.

Whenever possible, leave the power cord connected to an external AC power source while operating the instrument.

Battery Care

The battery capacity should be checked at least once every 6 months. Refer to the Alaris® System Technical Service Manual for test and replacement procedures.

If the PC Unit is to be stored at temperatures in excess of 86°F (30°C) for one or more months, the battery should be removed and placed in an environment of 50 - 86°F (10 - 30°C).

Battery Care and Maintenance (Continued)

Battery Care (Continued)

If the batteries are to be stored for more than 1 year, they should be charged at least once per year to prevent leakage and deterioration in performance due to self-discharge.

When the battery is first being put into use, or has been out of use for one or more months, it will not have full capacity due to deactivation of reactants.

Restore such batteries to original performance by repeating one or two cycles of fully charging and fully discharging.

Some temporary reduction in capacity might become apparent if the battery is partially discharged repeatedly. Doing one or two cycles of full discharge and full charge can restore full performance.

Battery Cautions and Disposal

Battery replacement should be performed by qualified service personnel while the instrument is not in use.

CAUTION

Do not open, incinerate or short circuit. Worn-out batteries must be disposed of properly, according to local regulations.

Inspection Requirements

To ensure that the Alaris® System remains in good operating condition, both regular and preventive maintenance inspections are required. Refer to the System Maintenance software for detailed instructions.

REGULAR INSPECTIONS

PROCEDURE	FREQUENCY
INSPECT FOR DAMAGE: <ul style="list-style-type: none">• Exterior Surfaces• IUI Connector• Keypad• Pole Clamp• Power Cord	<ul style="list-style-type: none">• Each usage• Each usage• Each usage• Each usage• Each usage
CLEANING	As required
START-UP	Each usage

WARNING

Failure to perform these inspections can result in improper instrument operation.

CAUTION

Preventive maintenance inspections should only be performed by qualified service personnel.

Alaris® Pump Module, Model 8100

Alaris® Syringe Module, Model 8110

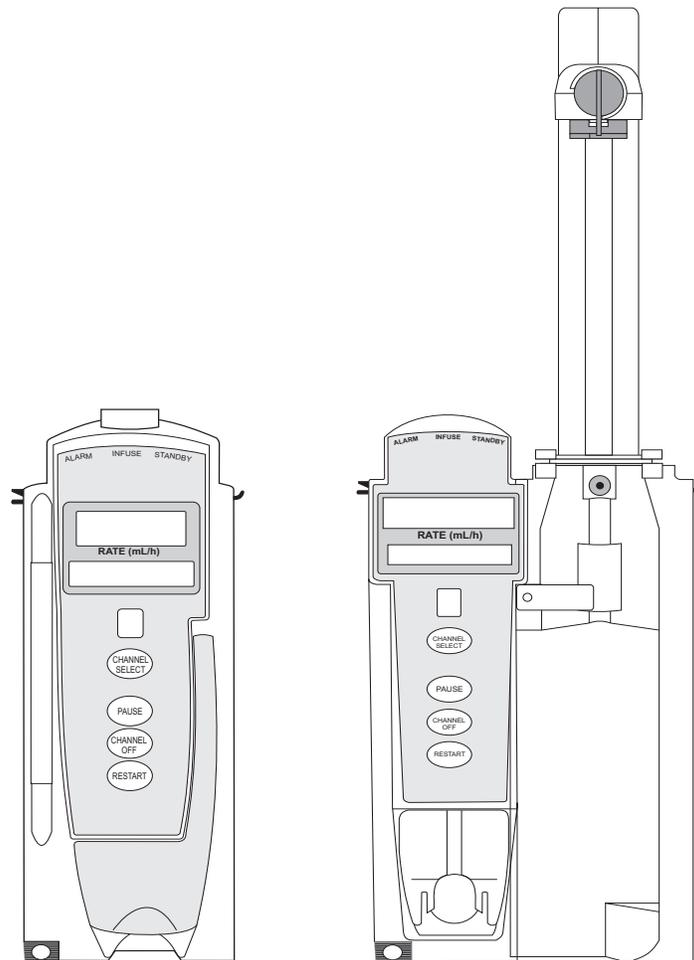

Getting Started

Introduction	2-1
Prepare Administration Set (Pump Module)	2-3
Load	2-3
Remove	2-5
Prime	2-5
Prepare Syringe and Administration Set (Syringe Module)	2-6
Load	2-7
Prime - Using Options Menu	2-11
Prime - Manual	2-16

Programming

Primary Infusion - With Guardrails® Suite MX Protection	2-19
Continuous Infusion	2-21
Bolus Dose	2-28
Intermittent Infusion	2-34
IV Fluid Infusion	2-38
Secondary Infusion - With Guardrails® Suite MX Protection (Pump Module)	2-44
Setup	2-44
Infusion	2-45
Stop Secondary and Return to Primary	2-49
Infusion - NO Guardrails® Suite MX Protection	2-50
Basic Infusion	2-51
Promote Basic Infusion to Guardrails® Suite MX Protection Infusion	2-52
Continuous Infusion - Drug Calculation	2-52
Bolus Dose	2-55
Secondary Infusion - NO Guardrails® Suite MX Protection (Pump Module)	2-56
Infusion	2-56
Stop Secondary and Return to Primary	2-57
Pause, Change, Restart Infusion	2-57
Pause and Restart Infusion	2-57
Change Rate or VTBI During Infusion	2-58
Restore Infusion	2-58
View and Clear Volume Infused	2-59
Channel Labels	2-60
Select	2-60
Remove	2-62
Anesthesia Mode	2-63
Delay Options	2-63
Delay Infusion	2-64
Schedule a Callback	2-67
Pause Infusion	2-68
Multidose Mode	2-69
Volume/Duration Enabled	2-71
Volume/Duration Disabled	2-72
Select Pressure Limit	2-74
Pump Module	2-74
Syringe Module	2-75

General Setup and Operation

System Start-Up/Setup.....	2-79
Set Up for Gravity Infusion (Pump Module).....	2-79
Change Solution Container (Pump Module).....	2-79
Change Syringe During Infusion (Syringe Module).....	2-80

General Information

Warnings and Cautions	2-81
General	2-81
Administration Sets.....	2-81
Epidural Administration.....	2-83
Guardrails® Suite MX.....	2-84
Administration Set/Syringe Information.....	2-84
SmartSite® Infusion Set (Pump Module).....	2-85
Safety Clamp Fitment (Pump Module).....	2-86
Compatible Syringes (Syringe Module).....	2-87
Features and Displays	2-88
Features and Definitions.....	2-88
Operating Features, Controls, Indicators.....	2-94
Displays	2-97
Drug Calculation Definitions and Formulas.....	2-98
Configurable Settings.....	2-99
Shared Infusion.....	2-99
Pump Module.....	2-100
Syringe Module.....	2-101
Specifications	2-102
Pump Module.....	2-102
Syringe Module.....	2-104
Symbols.....	2-108
Trumpet and Start-Up Curves	2-109
Pump Module.....	2-109
Syringe Module.....	2-110
Graphs	2-111

Troubleshooting and Maintenance

General.....	2-115
Alarms, Errors, Messages.....	2-115
Definitions	2-116
Audio Characteristics.....	2-116
Alarms.....	2-116
Errors	2-121
Messages	2-121
Possible End of Infusion Messages and Alerts (Syringe Module).....	2-123
Inspection Requirements.....	2-124

Introduction

This section of the DFU provides Pump Module (Model 8100) and Syringe Module (Model 8110) instructions and information. It is used in conjunction with:

- Alaris® product administration set instructions
- Drug product labeling
- PC Unit section of this DFU
- Pump Module Set Compatibility Card
- Pump Module Technical Service Manual
- Syringe Module Set Compatibility Card
- Syringe Module Technical Service Manual
- System Maintenance software (and its instructions) for Alaris® System check-in, maintenance, and wireless configuration

The Pump and Syringe Modules are intended for facilities that utilize infusion and/or syringe pumps for the delivery of fluids, medications, blood, and blood products using continuous or intermittent delivery through clinically acceptable routes of administration; such as, intravenous (IV), intra-arterial (IA), subcutaneous, epidural, enteral, or irrigation of fluid spaces. The Pump and Syringe Modules are indicated for use on adults, pediatrics, and neonates. Up to four Pump and/or Syringe Modules can be connected to the Alaris® System.

If a procedure/information applies to a specific module, the following identifiers indicate the module it applies to.

Pump Module :

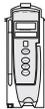

Syringe Module:

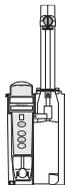

Administration Sets/Syringes: See "General Information" for specific "Administration Set/Syringe Information."

WARNING

Read all instructions, for both the infusion modules and PC Unit, before using the Alaris® System.

CAUTION

Rx Only

Introduction (Continued)

Alarms, Errors, Messages: See "Troubleshooting and Maintenance" for module-specific alarms, errors and messages.

Contraindications: None known.

Electromagnetic Environment: See "Appendix" section of this DFU ("Regulations and Standards," "Compliance").

Prepare Administration Set (Pump Module)



For instructions on how to go from checking in a Pump Module to preparing it for an infusion setup, see "General Setup and Operation."

Load

1. If a new set is being loaded, prime set (see "Prime" procedure).
2. Open Pump Module door.
3. Load administration set, as follows:
 - a. Hold upper fitment above fitment recess and lower into recess.
 - b. Ensure that tubing is not twisted.

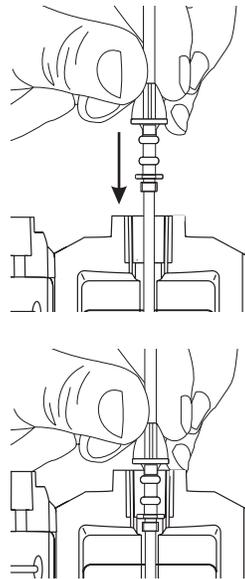

WARNINGS

- To prevent a **potential free-flow condition**, ensure that no extraneous object (for example, bedding, tubing, glove) is enclosed or caught in the Pump Module door.
- **Administration Sets:**
 - Use only **Pump Module/ Gemini Infusion System administration sets**. The use of any other set can cause improper instrument operation, resulting in an inaccurate fluid delivery or other potential hazard. For a list of compatible sets, refer to the Set Compatibility Card (provided separately).
 - **Discard if** packaging is not intact or protector caps are unattached.

CAUTIONS

- Failure to follow **proper administration set loading instructions** might lead to an instrument malfunction.
- Before operating the instrument, verify that the administration set is **free from kinks and correctly installed**.
- Insert upper fitment **before installing safety clamp^① fitment**.
- When **reloading an administration set**, leave the safety clamp^① fitment in the **closed** position (see "General Information," "Safety Clamp Fitment").

Prepare Administration Set (Pump Module) (Continued)



Load (Continued)

- c. Press safety clamp fitment into recess below mechanism. ^①
- d. Using a finger tip, firmly push tubing toward back of Air-in-Line (AIL) Detector.

CAUTION

To reduce the potential for nuisance AIL alarms, **ensure that tubing is fully inserted** in AIL Detector.

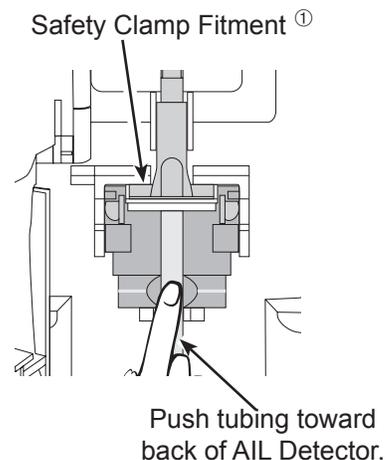

4. Close door and latch, as follows:
 - a. Close door and hold in a closed position by grasping door and instrument case with one hand.
 - b. Gently lower latch.

Safety clamp device is automatically disengaged. ^①

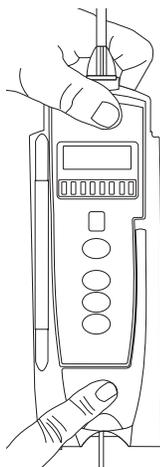

WARNINGS

- **Do not touch** the administration set while closing the door. Failure to follow this instruction can result in infusion rate inaccuracy.
- To **prevent a potential free-flow condition**, ensure that no extraneous object (for example, bedding, tubing, glove) is enclosed or caught in the Pump Module door.

5. Open roller clamp.
6. Verify that no fluid is flowing through drip chamber.

NOTE:

^① "Safety clamp" is referred to on a v9.0 PC Unit as "Flo-Stop."

Prepare Administration Set (Pump Module) (Continued)



Remove

1. Close roller clamp.
2. Open Pump Module door.
Set's safety clamp fitment automatically closes to prevent accidental free-flow. ^①

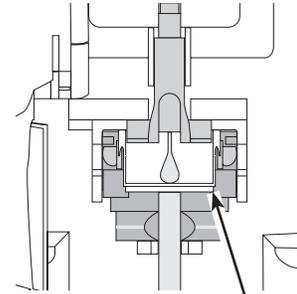

White Slide Clamp
(shown in closed position)

3. Remove set, as follows:
 - a. Gently pull tubing below Air-in-Line Detector forward and out.
 - b. Lift upper fitment from upper fitment receptacle.
4. If set is being removed to begin a gravity flow:
 - a. Depress blue ridged release tab on upper side of safety clamp device. ^①
 - b. Slide white slide clamp into blue fitment (open position).
 - c. Adjust flow rate using set's roller clamp.

NOTE:

^① "Safety clamp" is referred to on a v9.0 PC Unit as "Flo-Stop."

Prime

1. Prepare primary solution container in accordance with manufacturer's directions for use.
2. Open administration set package, remove set, and close roller clamp. (Refer to set's directions for use.)
3. Insert administration set spike into prepared fluid container, following accepted hospital/facility procedure, and hang container 20 inches above Pump Module.
4. Fill drip chamber to $\frac{2}{3}$ full.

Prepare Administration Set (Pump Module) (Continued)



Prime (Continued)

5. If container requires venting, open vent cap on administration set spike.
6. To prime tubing and clear air from injection sites and tubing fittings, slowly open roller clamp.
7. When priming is complete, close roller clamp.
8. Verify no fluid flow.

Prepare Syringe and Administration Set (Syringe Module)



To decrease start-up delays when infusing at a rate less than 1.0 mL/h, the following actions are recommended:

- Enable Fast Start (with Data Set development of System Configuration per profile).
- Use smallest syringe size possible (for example, if infusing 7.2 mL of fluid, use a 10 mL syringe).
- Prime Syringe Module as well as administration set (see "Prime - Using Options Menu").

For instructions on how to go from checking in a Syringe Module to preparing it for an infusion setup, including how to change a syringe during infusion, see "General Setup and Operation."

1. Prepare syringe (see "General Information," "Compatible Syringes") in accordance with manufacturer's directions for use.
2. Prepare administration set (refer to Set Compatibility Card, provided separately) in accordance with manufacturer's directions for use.
3. Attach upper fitting of administration set to syringe tip.

NOTE:

- ① For a list of compatible syringes, see "Compatible Syringes." For a list of compatible administration sets, refer to the Set Compatibility Card (available separately).

WARNING

Use only standard, single-use, disposable syringes with luer-lock connectors, and administration sets designed for use on syringe pumps. The **use of any other syringe or administration set** can cause improper instrument operation, resulting in inaccurate fluid delivery or pressure sensing, or other potential hazards. ①

Prepare Syringe and Administration Set (Syringe Module) (Continued)



Load

WARNING

Before loading or unloading the syringe, always turn off fluid flow to the patient, using the tubing clamp or stopcock. Uncontrolled fluid flow can occur when the administration set is not clamped or turned off, and can cause serious injury or death.

1. Ensure that instrument is as close to level of patient as possible—patient should be in line with **CHANNEL SELECT** key.

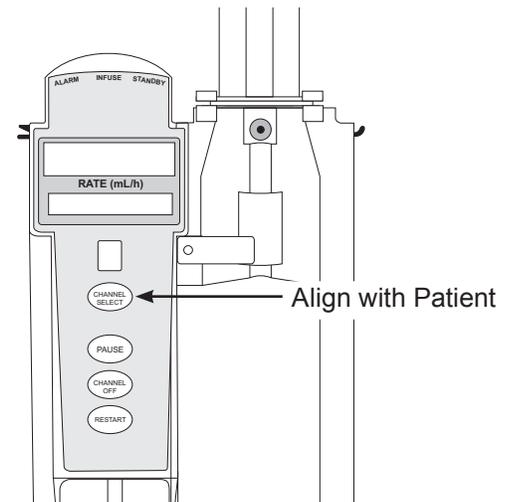

2. Open syringe barrel clamp.
 - a. Pull syringe barrel clamp out and hold.
 - b. Rotate clamp to left (clockwise or counter clockwise) until it clears syringe chamber.
 - c. Gently release clamp.

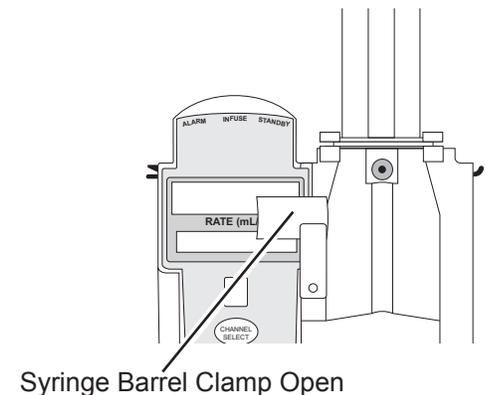

Prepare Syringe and Administration Set (Syringe Module) (Continued)



Load (Continued)

3. Raise drive head to its fully extended position.
 - a. Twist gripper control clockwise and hold in position. ①
 - b. While holding gripper control in open position, raise drive head to full extension.
 - c. Gently release gripper control.

4. Insert syringe (from front of instrument) by sliding flat edge of syringe barrel flange between barrel flange grippers.

Drive Head Fully Extended

Gripper Control/Drive Head Release in Open Position

Plunger Grippers Open

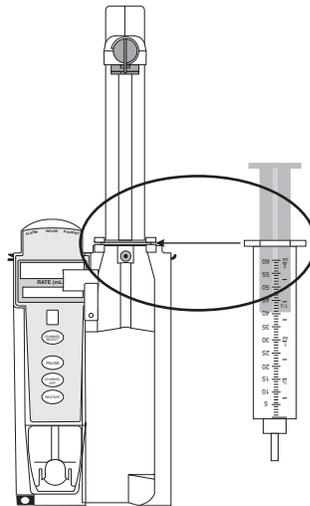
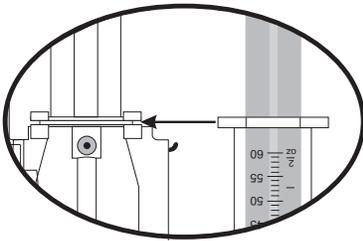
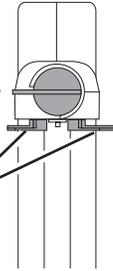

WARNING

Before loading the syringe, check it for damage or defects.

CAUTION

When initially loading the syringe, allow for the volume of fluid contained in the administration set and retained in the syringe at the end of an infusion, as this "dead space" will not be infused.

Prepare Syringe and Administration Set (Syringe Module) (Continued)



Load (Continued)

5. Lock syringe in place.
 - a. Pull syringe barrel clamp out and hold.
 - b. Rotate clamp to right (clockwise or counter clockwise) until it lines up with syringe.
 - c. Gently release clamp against syringe.

WARNING

Ensure that syringe barrel, flange, and plunger are installed and secured correctly. Failure to **install syringe correctly** can result in uncontrolled fluid flow to the patient, and can cause serious injury or death.

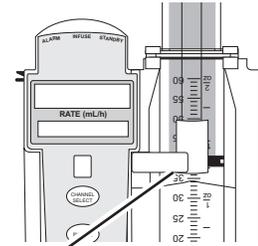

Syringe Barrel Clamp Closed

6. Lower drive head and lock plunger in place with plunger grippers.
 - a. Twist gripper control clockwise and hold in position. ①
 - b. While holding gripper control in open position, gently lower drive head until it makes contact with plunger flange.
 - c. Gently release gripper control.
 - d. Ensure that plunger grippers lock and hold plunger in place.

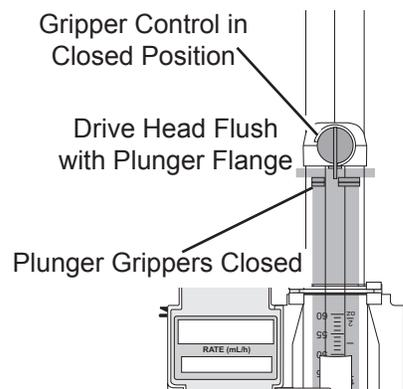

CAUTIONS

- To **avoid an occlusion** when loading a smaller size syringe, use extra care to close off administration set tubing and gently lower drive head against syringe plunger.
- For **smaller syringes** (such as; 1, 3 or 5 mL), stabilize the syringe plunger with thumb and index finger while carefully lowering the drive head. Ensure that the syringe plunger head makes contact with the small black sensor, located on the bottom of the drive head (between the plunger grippers).

Prepare Syringe and Administration Set (Syringe Module) (Continued)



Load (Continued)

7. Insert pressure sensing disc (if used), as follows: ②

WARNING

When the **pressure sensing disc is not being used** and an occlusion occurs, there is a risk of infusing pressurized buildup of infusates upon correction of the occlusion. To avoid an inadvertent bolus, relieve the pressure before restarting the infusion.

- a. Orient pressure sensing disc, as follows:
- fluid side up (patient side down)
 - cavity forward (membrane toward instrument)

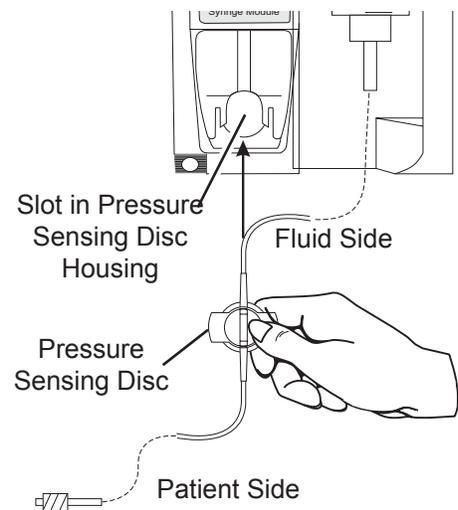

- b. Gently slide pressure sensing disc up into slot in pressure sensing disc housing.
- c. Apply firm upward pressure on pressure sensing disc (not tubing) until disc snaps into place.

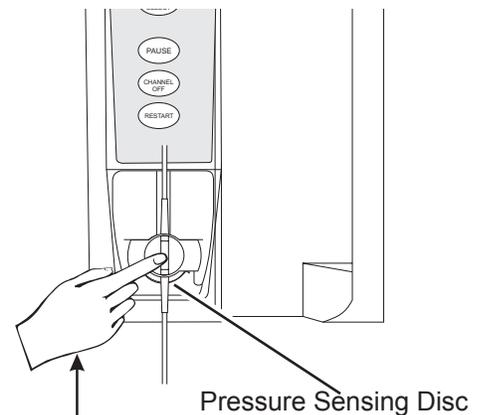

Prepare Syringe and Administration Set (Syringe Module) (Continued)



Load (Continued)

NOTES:

- ① The gripper control is spring loaded. When twisted to the open position and then released, it (and the plunger grippers) returns to the closed position.
- ② The following Syringe Module features are available only with extension sets fitted with a pressure sensing disc: (See "General Information," "Features and Displays" for definitions.)

Auto Pressure

Back Off (upon occlusion)

Customizable Pressure Alarm Settings (see "Occlusion Pressure" feature definition)

Dynamic Pressure Display (see "Pressure Tracking" feature definition)

Fast Start

Prime - Using Options Menu

The Priming option can be enabled at the time the Alaris® System is configured for use. The Priming selection (**PRIME** soft key) is available only after the syringe and infusion type have been selected, and prior to beginning an infusion.

If a pressure sensing disc is in use, it should be removed from the instrument before priming. See the applicable procedure (as follows) depending on whether or not a pressure sensing disc is used.

WARNING

When priming:

- Ensure that administration set is not connected to patient.
- Ensure that air is expelled from line prior to beginning infusion (unexpelled air in line could have serious consequences).

Failure to prime correctly can delay infusion delivery and cause the total volume to be infused to read higher than the actual total delivered to the patient.

CAUTION

During priming, the pressure limit alarms are temporarily increased to their maximum level.

Prepare Syringe and Administration Set (Syringe Module) (Continued)



Prime - Using Options Menu (Continued)

Administration Set With Pressure Sensing Disc

1. Ensure that administration set is not connected to patient.
2. If installed, remove pressure sensing disc from instrument.

Using a finger, apply firm downward pressure on pressure sensing disc (not tubing) until disc snaps loose from slot in pressure sensing disc housing.

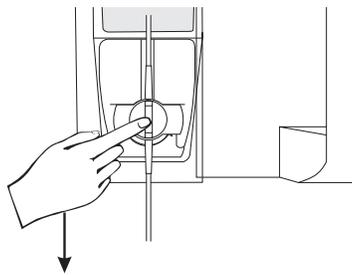

3. Press **OPTIONS** key.

CAUTION

The pressure sensing disc, if left installed during priming, can trap air that might not be totally expelled. To **ensure entrapped air is eliminated**, it is recommended that the pressure sensing disc be removed prior to priming and the membrane gently massaged with a finger while priming. After priming is completed, reinstall the pressure sensing disc.

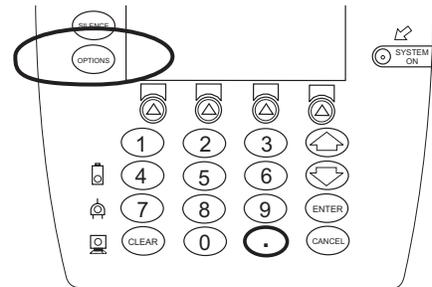

4. Press **Prime Set with Syringe** soft key.

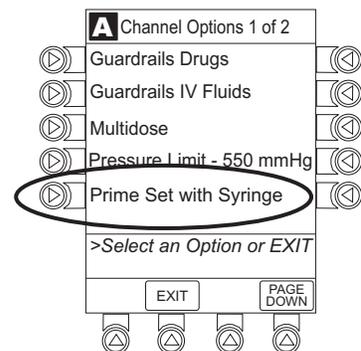

Prepare Syringe and Administration Set (Syringe Module) (Continued)



Prime - Using Options Menu (Continued)

Administration Set With Pressure Sensing Disc (Continued)

If pressure sensing disc was not removed prior to pressing **Prime Set with Syringe** soft key, a pressure sensing disc removal prompt is displayed.

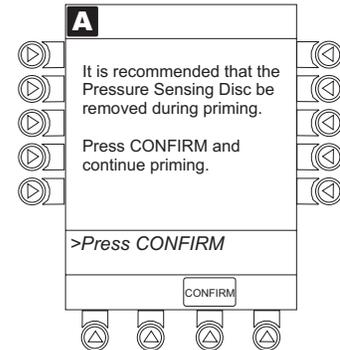

5. Invert pressure sensing disc so that patient side is up.
6. Hold pressure sensing disc between two fingers.

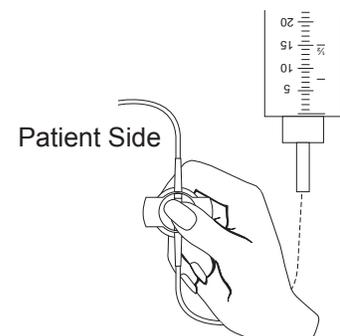

7. Press and hold **PRIME** soft key.

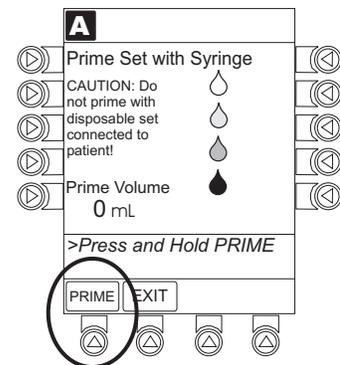

Prepare Syringe and Administration Set (Syringe Module) (Continued)



Prime - Using Options Menu (Continued)

Administration Set With Pressure Sensing Disc (Continued)

8. Gently massage pressure sensing disc to ensure that all air is expelled. Disc must remain inverted only until air is expelled. Continue to gently massage disc throughout priming to ensure that it does not become under- or over-filled.
9. Continue to prime until fluid flows and priming is complete.
Fluid is delivered during priming only while **PRIME** soft key is pressed. Each press of **PRIME** soft key delivers up to 2 mL of priming fluid per continuous press. To deliver additional amounts, press **PRIME** soft key again.
10. When priming is complete, release pressure sensing disc and **PRIME** soft key.
Volume used during priming is displayed but not added to VTBI or VI.

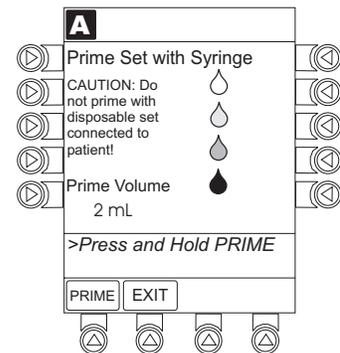

11. Reinstall pressure sensing disc, as follows:
 - a. Orient pressure sensing disc, as follows:
 - fluid side up (patient side down)
 - cavity forward (membrane toward instrument)
 - b. Gently slide pressure sensing disc up into slot in pressure sensing disc housing.

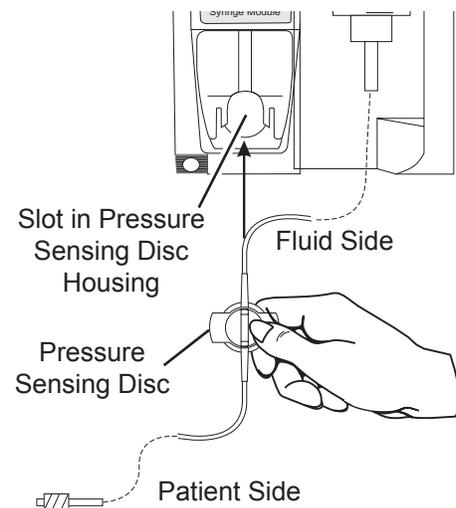

Prepare Syringe and Administration Set (Syringe Module) (Continued)



Prime - Using Options Menu (Continued)

Administration Set With Pressure Sensing Disc (Continued)

- c. Apply firm upward pressure on pressure sensing disc (not tubing) until disc snaps into place.

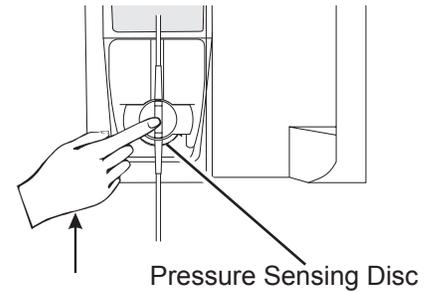

12. To return to main screen, press **EXIT** soft key.

If **EXIT** soft key is pressed before pressure sensing disc is reinstalled, a prompt to reinstall pressure sensing disc is displayed.

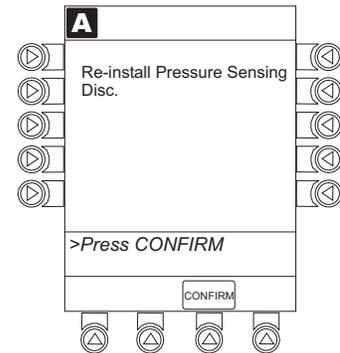

Administration Set With No Pressure Sensing Disc

1. Press **OPTIONS** key.
2. Press **Prime Set with Syringe** soft key.

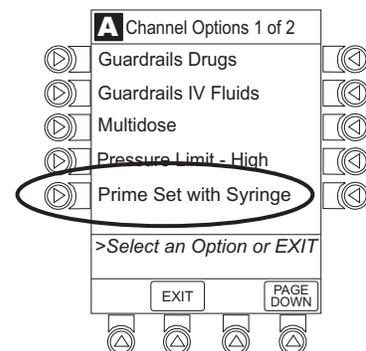

Prepare Syringe and Administration Set (Syringe Module) (Continued)



Prime - Using Options Menu (Continued)

Administration Set With No Pressure Sensing Disc (Continued)

3. Press and hold **PRIME** soft key until fluid flows and priming is complete.

Fluid is delivered during priming only while **PRIME** soft key is pressed. Each press of **PRIME** soft key delivers up to 2 mL of priming fluid per continuous press. To deliver additional amounts, press **PRIME** soft key again.

4. Release **PRIME** soft key.

Volume used during priming is displayed but not added to VTBI or VI.

5. To return to main screen, press **EXIT** soft key.

Prime - Manual

Use the following procedures to manually prime the administration set.

WARNING

When priming:

- Ensure that administration set is not connected to patient.
- Ensure that air is expelled from line prior to beginning infusion (unexpelled air in line could have serious consequences).

Failure to prime correctly can delay infusion delivery and cause the total volume to be infused to read higher than the actual total delivered to the patient.

Prepare Syringe and Administration Set (Syringe Module) (Continued)



Prime - Manual (Continued)

Administration Set With Pressure Sensing Disc

1. Ensure that administration set is not connected to patient.
2. If installed, remove pressure sensing disc from instrument.

Using a finger, apply firm downward pressure on pressure sensing disc (not tubing) until disc snaps loose from slot in pressure sensing disc housing.

CAUTION

The pressure sensing disc, if left installed during priming, can trap air that might not be totally expelled. To **ensure that entrapped air is eliminated**, it is recommended that the pressure sensing disc be removed prior to priming and the membrane gently massaged with a finger while priming. After priming is completed, reinstall the pressure sensing disc.

3. Invert pressure sensing disc so that patient side is up.
4. Hold pressure sensing disc between two fingers. ①
5. Slowly prime set while gently massaging pressure sensing disc to ensure that all air is expelled. Disc must remain inverted only until air is expelled. Continue to gently massage disc throughout priming to ensure that it does not become under- or over-filled.
6. When priming is complete (no air exists), close set clamp.

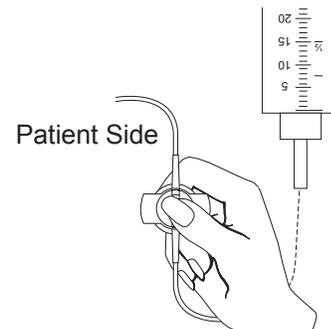

NOTE:

- ① When manually priming (per hospital/facility protocol) and an administration set having a pressure sensing disc is in use, depress the disc between two fingers while priming and prime uphill (distal end of pressure sensing disc/tubing pointing upward).

Prepare Syringe and Administration Set (Syringe Module) (Continued)



Prime - Manual (Continued)

Administration Set With No Pressure Sensing Disc

1. Prime per hospital protocol.
2. When priming is complete (no air exists), close set clamp.

Eliminate Mechanical Slack

To eliminate mechanical slack or free play, and minimize delays in the delivery of medication, especially when infusing at a rate lower than 1.0 mL/h, it is recommended that the instrument be primed per the following procedure.

1. Load syringe (see "Load" procedure). If a pressure sensing disc is being used, do not install disc until priming is complete.
2. Select syringe and infusion type (see "Programming" chapter).
3. Open administration set clamp.
4. Prime, as follows, using Priming option (see "Prime - Using Options Menu"):
 - a. Follow applicable procedure (based on whether or not pressure sensing disc is installed) through step to press and hold **PRIME** soft key.
 - b. Prime until fluid drips from end of tubing.
 - c. Complete procedure (installing pressure sensing disc, if applicable, and exiting options menu).

References throughout this procedure to specific drugs and drug doses are for illustration purposes only. Refer to specific drug product labeling for information concerning appropriate administration techniques and dosages.

See "General Information," "Features and Displays" and the PC Unit section of this DFU for information about:

- Displays
- Operating Features, Controls, Indicators

The majority of user interface programming is identical for both the Pump Module and Syringe Module. When referring to both modules, the term "infusion modules" is used.

Primary Infusion - With Guardrails® Suite MX Protection

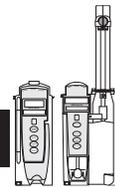

The following procedures are to be used only when the drug to be infused is listed in the Drug Library. To access the Drug Library, a hospital-defined best-practice Data Set must be transferred using the Editor Software and the Profiles feature must be enabled.

1. Perform following steps (see PC Unit section of this DFU, "General Setup and Operation," "Start-Up"):
 - a. Power on system.
 - b. Choose **Yes** or **No** to **New Patient?**
 - c. Confirm current profile or select a new profile.
 - d. Enter patient identifier, if required.
2. Prepare and load syringe/administration set (see "Getting Started").
3. Prime (see "Getting Started").

WARNING

When the **pressure sensing disc is not being used** and an occlusion occurs, there is a risk of infusing pressurized buildup of infusates upon correction of the occlusion. To avoid an inadvertent bolus, relieve the pressure before restarting the infusion.



Primary Infusion - With Guardrails® Suite MX Protection (Continued)

4. Press **CHANNEL SELECT** key.

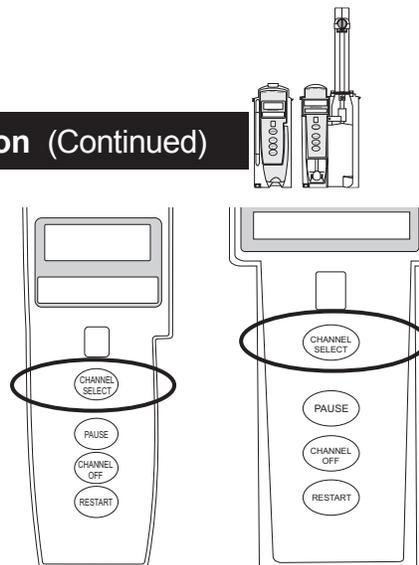

5. Syringe Module: Select syringe type and size, as follows; otherwise, proceed to step 6. ①

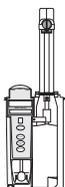

WARNING

Ensure that the displayed **syringe manufacturer and syringe size** correctly identify the installed syringe. Mismatches might cause an under-infusion or over-infusion to the patient that could result in serious injury and/or death. For a list of compatible syringes, see "General Information," "Compatible Syringes." If the installed syringe is displayed and selected, but is not recognized, servicing is required (see "Maintenance," "Service Information" in "Appendix" section of this DFU).



- a. Press soft key next to installed syringe type and size. If a default syringe list has been enabled and correct syringe cannot be found, press **ALL SYRINGES** soft key.

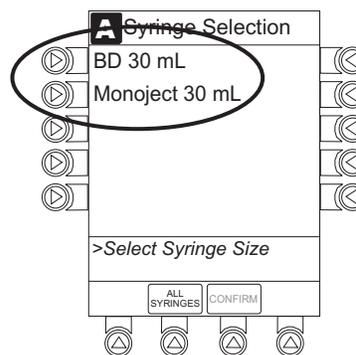

Primary Infusion - With Guardrails® Suite MX Protection (Continued)

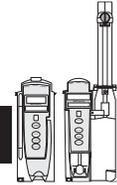

- b. To accept, press **CONFIRM** soft key.

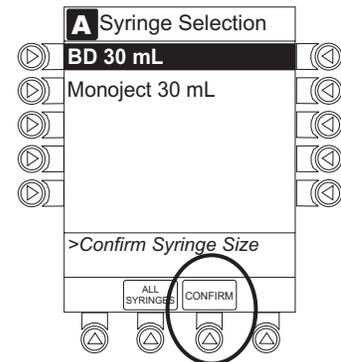

6. Start applicable infusion, as described in following procedures:

Continuous Infusion
Bolus Dose
Intermittent Infusion
IV Fluid Infusion

NOTE:

- ① At the start of a Syringe Module infusion program, the system prompts to select and confirm the syringe type and size. The system automatically detects the syringe size, and lists syringe types and sizes that most closely match the installed syringe. If the syringe is not recognized, **Syringe not recognized** is displayed.

Continuous Infusion

When using a drug listed in the Drug Library, the drug parameters are automatically calculated, based on:

- drug selected
- weight entry (if required)
- rate or dose entry
- VTBI entry (Syringe Module: if other than All)

Primary Infusion - With Guardrails® Suite MX Protection (Continued)



Continuous Infusion (Continued)

1. Press **Guardrails Drugs** soft key.

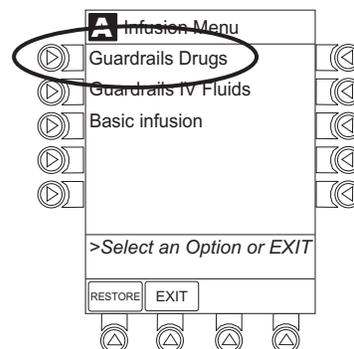

2. Press soft key next to desired drug.

- To view additional drugs/concentrations, press a soft key next to a letter group to navigate through alphabet, and/or **PAGE UP** and **PAGE DOWN** soft keys.

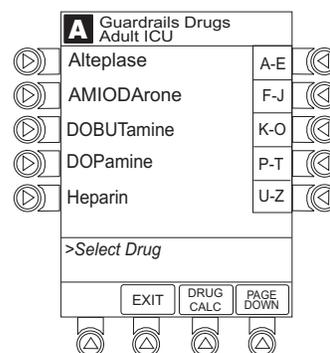

- If applicable, an optional hospital-defined therapy or clinical indication for delivery of this infusion could appear (as in illustrated example, which reflects use of Alteplase). Different limits can be defined for same drug with different therapeutic indications.

Therapy indication appears on drug or IV fluid confirmation screen. Once drug or IV fluid has been confirmed, therapy indication appears in title bar.

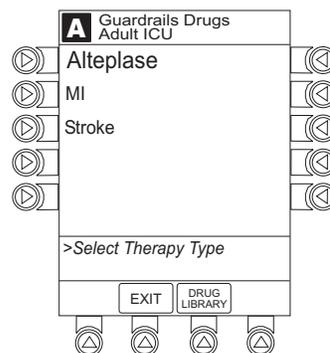

Primary Infusion - With Guardrails® Suite MX Protection (Continued)



Continuous Infusion (Continued)

- If applicable, a weight-based or non weight-based option for delivery of this infusion could appear (as in illustrated example, which reflects use of Heparin).

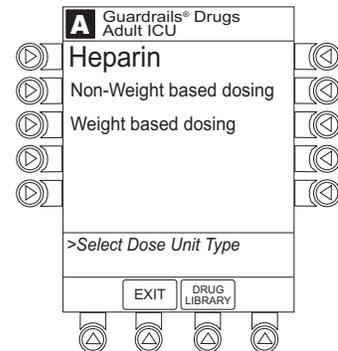

- If applicable, multiple concentration listings for delivery of this infusion could appear (as in illustrated example, which reflects use of Dopamine).

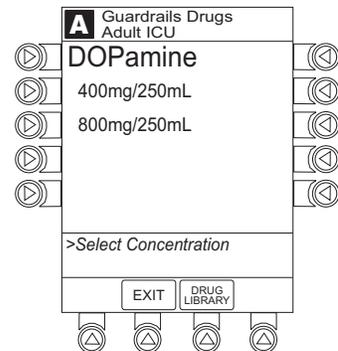

- To continue programming, press **Yes** soft key. ^①
Bolus dose units appear if Bolus Dose is enabled.
OR
To change selection, press **No** soft key.

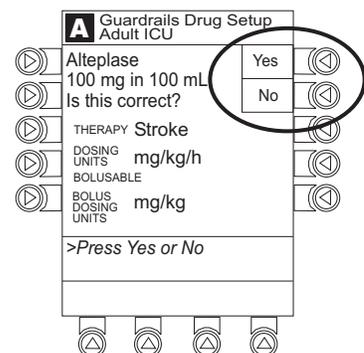

Primary Infusion - With Guardrails® Suite MX Protection (Continued)

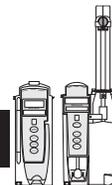

Continuous Infusion (Continued)

- If **Yes** was selected and facility has defined a Clinical Advisory for that drug, a message appears. To indicate information has been noted and continue programming, press **CONFIRM** soft key.

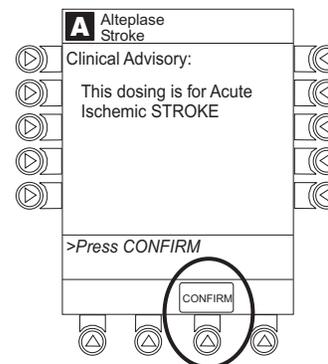

- If **Yes** was selected to continue programming, drug amount and diluent volume (if defined in Drug Library) are automatically entered for selected drug.

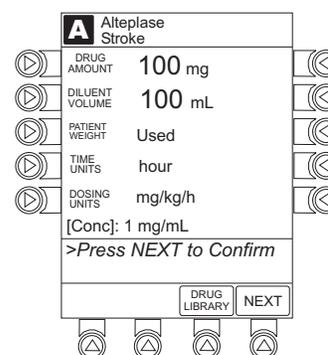

- If selected drug had "__ / __ mL" concentration, drug amount and diluent volume need to be entered.
- If selected drug is not weight-based, **Not Used** is displayed in **PATIENT WEIGHT** field.
- If hospital/facility practice guidelines identify selected drug as weight-based, prompt for a patient weight in kilograms appears (as in illustrated example, which reflects use of Alteplase).^②

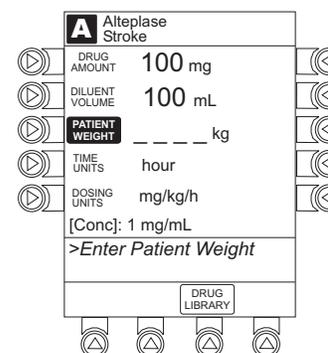

4. Verify correct parameters and press **NEXT** soft key to confirm.

Primary Infusion - With Guardrails® Suite MX Protection (Continued)

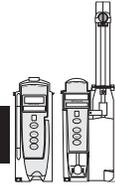

Continuous Infusion (Continued)

- An optional hospital-defined and editable starting value for continuous infusion dose might already be entered.

OR

To make a rate or dose entry, press applicable soft key, **RATE** or **DOSE**, and use numeric data entry keys (other value is calculated and displayed).

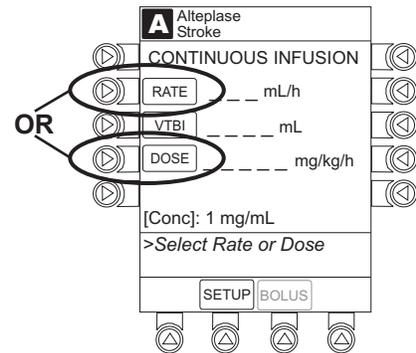

- To enter volume to be infused, press **VTBI** soft key and use numeric data entry keys.

- Pump Module:**



- When VTBI is less than 10 mL/h, entry can be to two decimal places (one-hundredth of a mL).
- In Drug Calculation mode, system infuses at calculated rate rounded to nearest one-hundredth of a mL per hour (as displayed on programming screen). Rate shown in Rate Display is rounded to nearest one-tenth of a mL per hour.

- BOLUS** soft key appears only if Bolus Dose is enabled within selected profile, drug is bolusable, and a VTBI is entered.

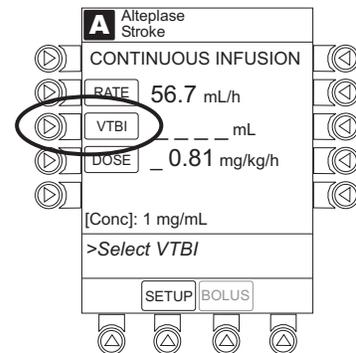

Primary Infusion - With Guardrails® Suite MX Protection (Continued)

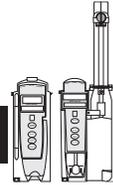

Continuous Infusion (Continued)

- Syringe Module:



- If ALL Mode is enabled for syringe configuration in Data Set, **ALL** is displayed in **VTBI** field and estimated available volume in syringe is displayed.

OR

If ALL Mode is disabled for syringe configuration in Data Set, estimated available volume in syringe is displayed when **VTBI** soft key is pressed.

- To enter or change a numeric **VTBI** value, press **VTBI** soft key and use numeric data entry keys.
- To deliver entire contents of syringe: Keep an **ALL VTBI** value, or press **ALL** soft key to change a numeric **VTBI** value to **ALL**.

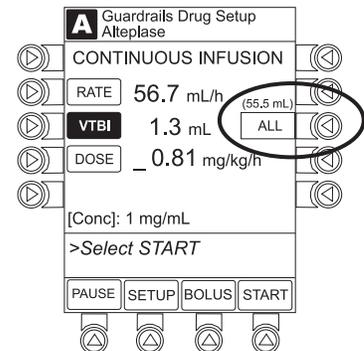
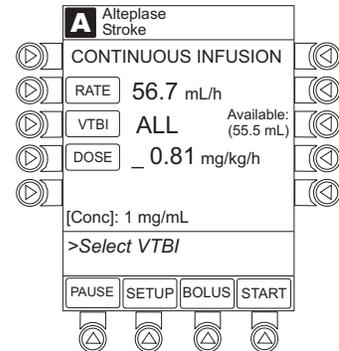

- Verify correct parameters and press **START** soft key.

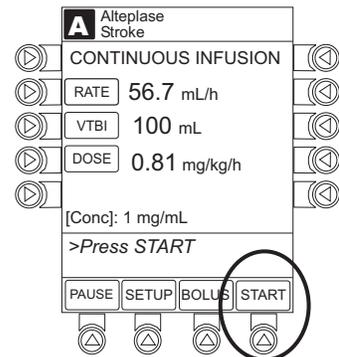

Primary Infusion - With Guardrails® Suite MX Protection (Continued)



Continuous Infusion (Continued)

- If programmed continuous dose infusion is outside Soft Limit for that care area, an audio alert sounds and a visual prompt appears before programming can continue. If **Yes** soft key is pressed, programming continues; if **No** soft key is pressed, infusion needs to be reprogrammed.

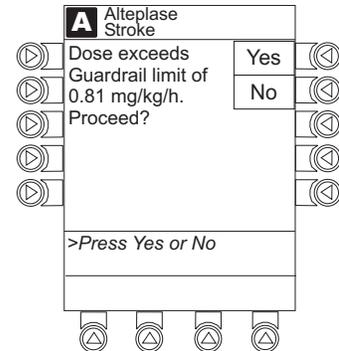

- If programmed continuous dose infusion is outside Hard Limit for that care area, an audio alert sounds and a visual prompt appears before programming can continue. Infusion needs to be reprogrammed.

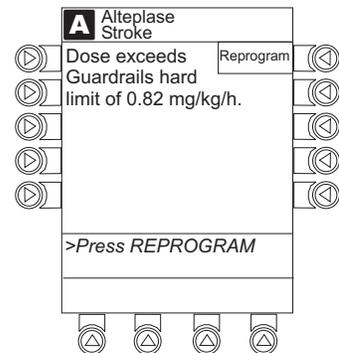

- If a dose outside of Soft Limits has been entered and verified as correct, Message Display also shows either "LLL" for a low dose or "^^^" for a high dose.
- If a Soft Limit is overridden, **G** icon is displayed. When **G** soft key is pressed, all applicable out-of-range limits are listed.

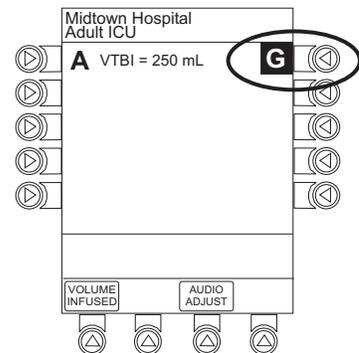

Primary Infusion - With Guardrails® Suite MX Protection (Continued)

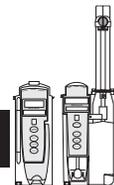

Continuous Infusion (Continued)

8. Syringe Module:

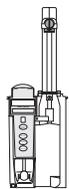

- Unclamp tubing and attach administration set to patient.
- Unclamping tubing and starting infusion before attaching administration set to patient minimizes any potential bolus that can be released from pressure built up in set due to normal syringe loading and priming.

NOTES:

- ① The facility can choose to prepopulate standard drug concentrations, or leave an open entry (_ _ / _ _ mL) and allow the clinician to enter the desired concentration.
- ② Once a patient weight is entered, for any module, it is automatically entered for any subsequent weight-based calculation.

Bolus Dose

A bolus dose can be programmed at the beginning of, or during, an infusion. The drug being programmed must be a bolusable drug selected from the Drug Library or a non-library drug, as described in the following procedures. ① ② ③ ④

1. Set up infusion as described in "Continuous Infusion" procedure, but do not start infusion.
2. Press **BOLUS** soft key.
 - If programmed continuous dose infusion is outside Soft Limit for that care area, an audio alert sounds and a visual prompt appears before programming can continue. If **Yes** soft key is pressed, programming continues; if **No** soft key is pressed, infusion needs to be reprogrammed.
 - If programmed continuous dose infusion is outside Hard Limit for that care area, an audio alert sounds and a visual prompt appears before programming can continue. Infusion needs to be reprogrammed.

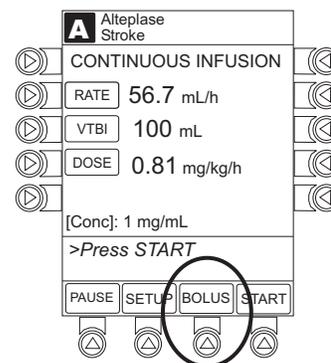

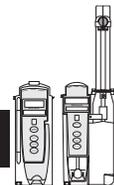

Bolus Dose (Continued)

3. An optional hospital-defined and editable starting value for bolus dose and/or bolus rate duration might already be entered.

OR

To enter bolus dose, use numeric data entry keys.

- After a bolus dose and weight (if used) are entered, bolus VTBI and concentration [conc] alternate in Main Display.
- If no weight has previously been programmed in system and bolus dose is weight-based, weight entry is empty.
- If programmed continuous dose is weight-based, programmed weight is displayed.
- If bolus dose is not weight-based, **Not Used** is displayed in **PATIENT WEIGHT** field.

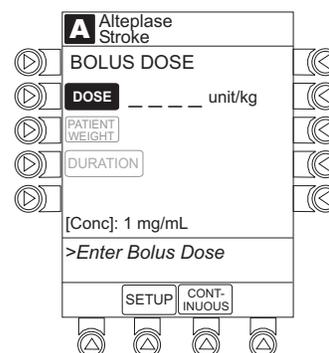

4. To enter or change patient weight (if used), use applicable following procedure, depending on whether or not continuous dose is weight-based.

- To enter a weight when continuous dose is not weight-based:
 - a. Press **PATIENT WEIGHT** soft key.
 - b. To enter patient weight, use numeric data entry keys.

OR

- To change weight when continuous dose is weight-based:
 - a. Press **SETUP** soft key.
 - b. Press **PATIENT WEIGHT** soft key.
 - c. To change patient weight, use numeric data entry keys.

Primary Infusion - With Guardrails® Suite MX Protection (Continued)

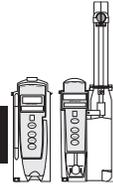

Bolus Dose (Continued)

- d. Press **NEXT** soft key.

If a continuous infusion is running, a prompt to confirm weight change appears.

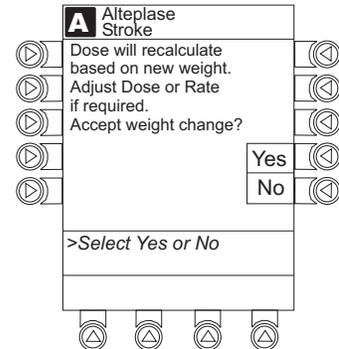

- e. Press **BOLUS** soft key.

- f. To enter bolus dose, use numeric data entry keys.

5. Press **DURATION** soft key.

6. To enter bolus duration, use numeric data entry keys.

OR

To deliver bolus dose at maximum safe rate possible for selected drug and setup, and automatically calculate bolus duration, press **Rapid Bolus** soft key.

TOTAL DOSE alternates with **INFUSE AT** rate.

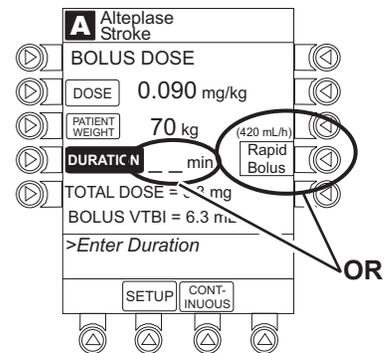

7. Verify correct parameters and press **START** soft key. ^⑤

- If programmed bolus dose and/or bolus dose duration is outside Soft Limit for that care area, an audio alert sounds and a visual prompt appears before programming can continue. If **Yes** soft key is pressed, programming continues; if **No** soft key is pressed, infusion needs to be reprogrammed.
- If programmed bolus dose and/or bolus dose duration is outside Hard Limit for that care area, an audio alert sounds and a visual prompt appears before programming can continue. Infusion needs to be reprogrammed.

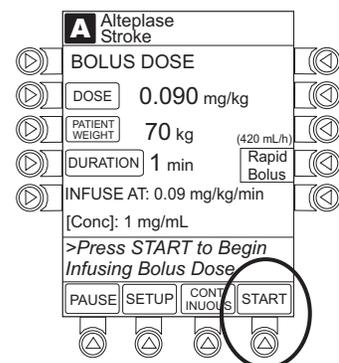

Primary Infusion - With Guardrails® Suite MX Protection (Continued)

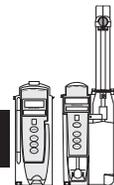

Bolus Dose (Continued)

- If a bolus dose outside of Soft Limits has been entered and verified as correct, Message Display also shows either "LLL" for a low dose or "↑↑↑" for a high dose.
- If a Soft Limit is overridden, **G** icon is displayed. When **G** soft key is pressed, all applicable out-of-range limits are listed.

8. Syringe Module:

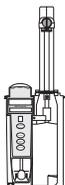

- If bolus dose was programmed at beginning of infusion, unclamp tubing and attach administration set to patient.
- Unclamping tubing and starting infusion before attaching administration set to patient minimizes any potential bolus that can be released from pressure built up in set due to normal syringe loading and priming.

Stop Bolus Dose

The display examples in this procedure represent stopping a bolus dose which was programmed using the Drug Library. Even where the displays are different when stopping a bolus dose which was programmed using a non-library drug, the procedure is the same.

1. Press **CHANNEL SELECT** key.
2. Press **STOP BOLUS** soft key.

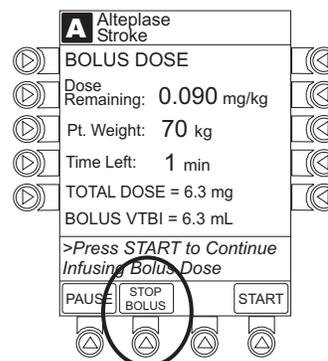

Primary Infusion - With Guardrails® Suite MX Protection (Continued)

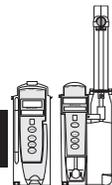

Bolus Dose (Continued)

Stop Bolus Dose (Continued)

- To stop bolus and start continuous infusion, press **Yes** soft key.

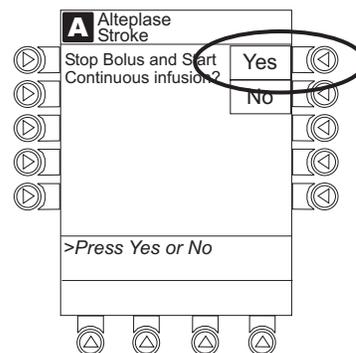

- To stop continuous infusion, press and hold **CHANNEL OFF** key until a beep is heard (approximately 1.5 seconds).⁶

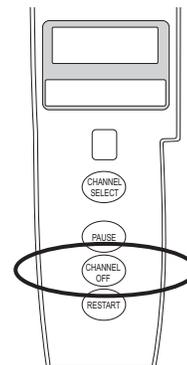

Restore Bolus Dose

A bolus dose can be restored after it has completed, either prior to or after the module has been turned off, as indicated in the following procedures.

The display examples in this procedure represent restoring a bolus dose which was programmed using the Drug Library. Even where the displays are different when restoring a bolus dose which was programmed using a non-library drug, the procedure is the same.

- Bolus dose completed - module not turned off:
 - Press **CHANNEL SELECT** key.
 - Verify infusion parameters and press **BOLUS** soft key.

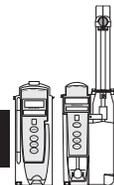

Bolus Dose (Continued)

Restore Bolus Dose (Continued)

- c. Press **RESTORE** soft key.
 - d. Verify dosing parameters and press **START** soft key.
2. Bolus dose completed - module turned off:
- a. Press **CHANNEL SELECT** key.
 - b. Press **RESTORE** soft key.
 - c. Verify parameters and press **NEXT** soft key.
 - d. Verify infusion parameters and press **BOLUS** soft key.
 - e. Press **RESTORE** soft key.
 - f. Verify dosing parameters and press **START** soft key.

NOTES:

- ① If the Bolus Dose feature is enabled, the **BOLUS** soft key appears in the Continuous Infusion screen and becomes active when a VTBI is entered.
- ② The bolus VTBI cannot exceed the programmed continuous infusion VTBI.
- ③ Programming and starting a bolus dose deletes any programmed delay.
- ④ If no continuous rate is entered, the infusion ends when the bolus has been delivered. No KVO infusion follows.
- ⑤ To see details during the bolus infusion, press the **CHANNEL SELECT** key.
- ⑥ The Pump Module keypad is used in the illustration but the key is the same for the Syringe Module.

Primary Infusion - With Guardrails® Suite MX Protection (Continued)



Intermittent Infusion

When using a drug listed in the Drug Library, the drug parameters are automatically delivered, based on:

- drug selected
- weight or body surface area (BSA) entry (if required)
- dose entry
- rate or duration dose entry
- VTBI entry

Syringe Module: The KVO option is disabled when an intermittent infusion is programmed.

1. Press **Guardrails Drugs** soft key.
2. Press soft key next to desired drug.
 - To view additional drugs, press a soft key next to a letter group to navigate through alphabet, and/or **PAGE UP** and **PAGE DOWN** soft keys.
 - If applicable, an optional hospital-defined therapy or clinical indication for delivery of this infusion could appear. Different limits can be defined for same drug with different therapeutic indications.
 - If applicable, a weight-based, non weight-based, or BSA-based option for delivery of this infusion could appear.
 - If applicable, multiple concentration listings for delivery of this infusion could appear.
3. To continue programming, press **Yes** soft key. ^①

OR

To change selection, press **No** soft key.

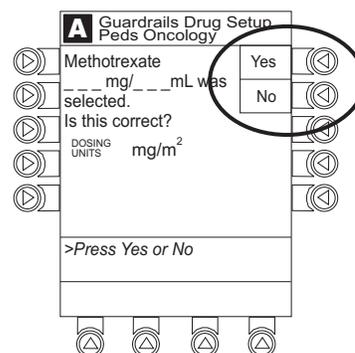
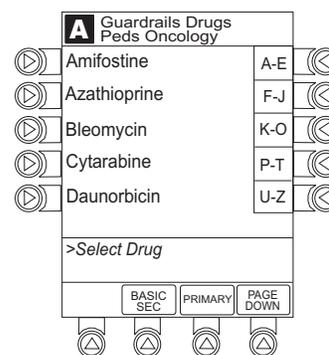

Primary Infusion - With Guardrails® Suite MX Protection (Continued)



Intermittent Infusion (Continued)

- If **Yes** was selected and facility has defined a Clinical Advisory for that drug, a message appears. To indicate information has been noted and continue programming, press **CONFIRM** soft key.
- If **Yes** was selected to continue programming, drug amount and diluent volume (if defined in Drug Library) are automatically entered for selected drug.
- If selected drug had "__ / __ mL" concentration, drug amount and diluent volume need to be entered.
- If selected drug is not weight-based, **Not Used** is displayed in **PATIENT WEIGHT** field.
- If hospital/facility practice guidelines identify selected drug as weight-based, prompt for a patient weight in kilograms or BSA appears (as in illustrated example, which reflects use of Methotrexate).^②

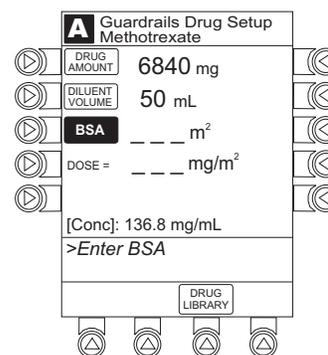

4. Verify correct parameters and press **NEXT** soft key to confirm.
 - If programmed total dose drug amount is outside Soft Limit for that care area, an audio alert sounds and a visual prompt appears before programming can continue. If **Yes** soft key is pressed, programming continues; if **No** soft key is pressed, infusion needs to be reprogrammed.
 - If programmed total dose drug amount is outside Hard Limit for that care area, an audio alert sounds and a visual prompt appears before programming can continue. Infusion needs to be reprogrammed.

Primary Infusion - With Guardrails® Suite MX Protection (Continued)



Intermittent Infusion (Continued)

- If a dose outside of Soft Limits has been entered and verified as correct, Message Display also shows either "LLL" for a low dose or "↑↑↑" for a high dose.
- If a Soft Limit is overridden, **G** icon is displayed. When **G** soft key is pressed, all applicable out-of-range limits are listed.

5. VTBI entry:

• Pump Module:

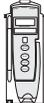

- When VTBI is less than 10 mL/h, entry can be to two decimal places (one-hundredth of a mL).
- VTBI is prepopulated with diluent volume of infusion. To change VTBI, press **VTBI** soft key and use numeric data entry keys.

• Syringe Module:

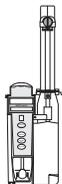

- If ALL Mode is enabled for syringe configuration in Data Set, **ALL** is displayed in **VTBI** field and estimated available volume in syringe is displayed.

OR

If ALL Mode is disabled for syringe configuration in Data Set, estimated available volume in syringe is displayed when **VTBI** soft key is pressed.

- To enter or change a numeric **VTBI** value, press **VTBI** soft key and use numeric data entry keys.
- To deliver entire contents of syringe: Keep an **ALL VTBI** value, or press **ALL** soft key to change a numeric **VTBI** value to **ALL**.

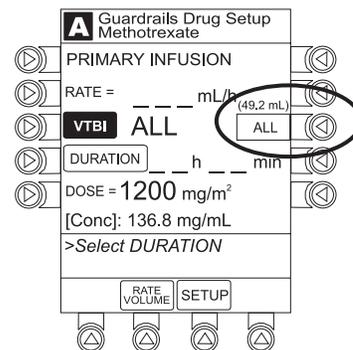
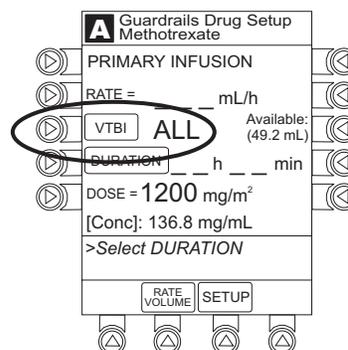

Primary Infusion - With Guardrails® Suite MX Protection (Continued)



Intermittent Infusion (Continued)

6. If an optional hospital-defined and editable starting value for intermittent duration is not already entered, enter duration or rate, as follows:
 - To enter duration, press **DURATION** soft key and use numeric data entry keys (rate value is calculated and displayed).
 - To enter rate, press **RATE VOLUME** soft key and use numeric data entry keys.
7. Verify correct parameters and press **START** soft key.
 - If programmed duration is outside Soft Limit for that care area, an audio alert sounds and a visual prompt appears before programming can continue. If **Yes** soft key is pressed, programming continues; if **No** soft key is pressed, infusion needs to be reprogrammed.
 - If programmed duration is outside Hard Limit for that care area, an audio alert sounds and a visual prompt appears before programming can continue. Infusion needs to be reprogrammed.
 - If a Soft Limit is overridden, **G** icon is displayed. When **G** soft key is pressed, all applicable out-of-range limits are listed

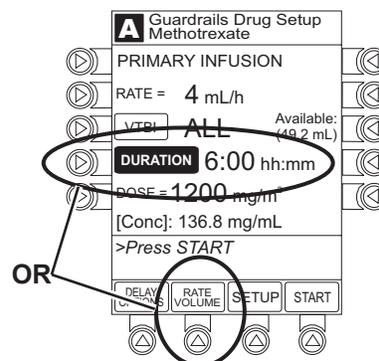

8. Syringe Module:
 - Unclamp tubing and attach administration set to patient.
 - Unclamping tubing and starting infusion before attaching administration set to patient minimizes any potential bolus that can be released from pressure built up in set due to normal syringe loading and priming.

NOTES:

- ① The facility can choose to prepopulate standard drug concentrations, or leave an open entry (_ _ / _ _ mL) and allow the clinician to enter the desired concentration.
- ② Once a patient weight or BSA is entered, for any module, it is automatically entered for any subsequent weight-based calculation.

Primary Infusion - With Guardrails® Suite MX Protection (Continued)

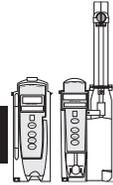

IV Fluid Infusion

1. Press **Guardrails IV Fluids** soft key.
2. Press soft key next to IV Fluid to be delivered.

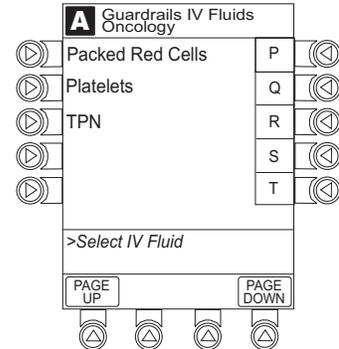

3. To confirm selection, press **Yes** soft key.

OR

To return to IV Fluid library list, press **No** soft key.

If **Yes** was selected and facility has defined a Clinical Advisory for that drug, a message appears. To indicate information has been noted and continue programming, press **CONFIRM** soft key.

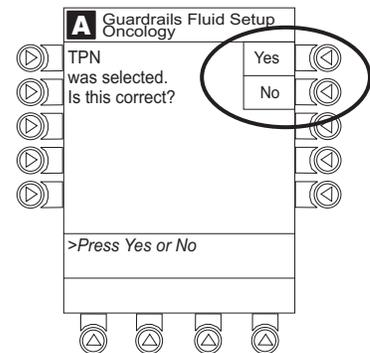

4. Start applicable infusion, as described in following procedures:

Rate/Volume Infusion
Volume/Duration Infusion

Rate/Volume Infusion

1. To enter flow rate, press **RATE** soft key and use numeric data entry keys.

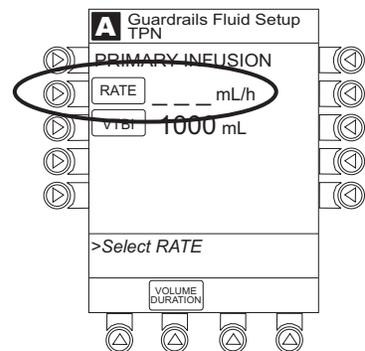

Primary Infusion - With Guardrails® Suite MX Protection (Continued)

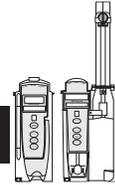

IV Fluid Infusion (Continued)

Rate/Volume Infusion (Continued)

- To enter **VTBI**, press **VTBI** soft key and use numeric data entry keys.

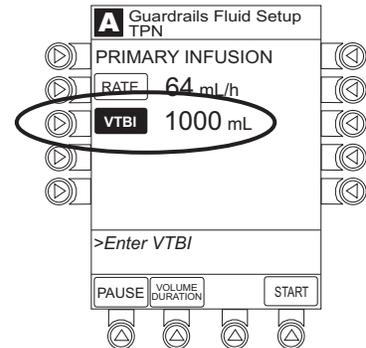

- Syringe Module:

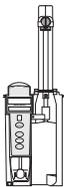

- If ALL Mode is enabled for syringe configuration in Data Set, **ALL** is displayed in **VTBI** field and estimated available volume in syringe is displayed.

OR

If ALL Mode is disabled for syringe configuration in Data Set, VTBI ALL option is not available and estimated available volume in syringe is displayed when **VTBI** soft key is pressed.

- To enter or change a numeric **VTBI** value, press **VTBI** soft key and use numeric data entry keys.
- To deliver entire contents of syringe: Keep an **ALL VTBI** value, or press **ALL** soft key to change a numeric **VTBI** value to **ALL**.

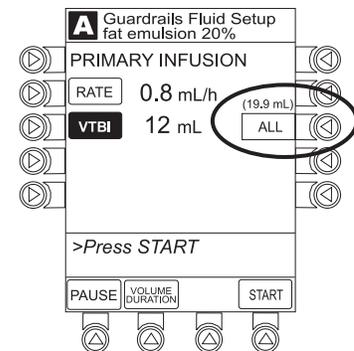
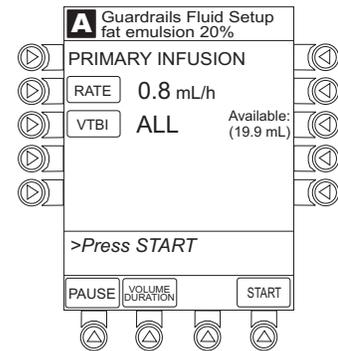

Primary Infusion - With Guardrails® Suite MX Protection (Continued)



IV Fluid Infusion (Continued)

Rate/Volume Infusion (Continued)

- Verify correct infusion parameter entry and press **START** soft key. ^①
 - If programmed IV Fluid is outside Soft Limit for that care area, an audio alert sounds and a visual prompt appears before programming can continue. If **Yes** soft key is pressed, programming continues; if **No** soft key is pressed, infusion needs to be reprogrammed.
 - If programmed IV Fluid is outside Hard Limit for that care area, an audio alert sounds and a visual prompt appears before programming can continue. Infusion needs to be reprogrammed.
 - If a Soft Limit is overridden, **G** icon is displayed. When **G** soft key is pressed, all applicable out-of-range limits are listed.

4. Syringe Module:

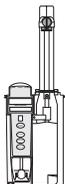

- Unclamp tubing and attach administration set to patient.
- Unclamping tubing and starting infusion before attaching administration set to patient minimizes any potential bolus that can be released from pressure built up in set due to normal syringe loading and priming.

Volume/Duration Infusion

- Press **VOLUME DURATION** soft key.

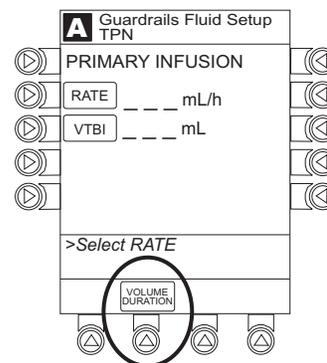

Primary Infusion - With Guardrails® Suite MX Protection (Continued)

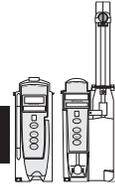

IV Fluid Infusion (Continued)

Volume/Duration Infusion (Continued)

- To enter **VTBI**, press **VTBI** soft key and use numeric data entry keys.

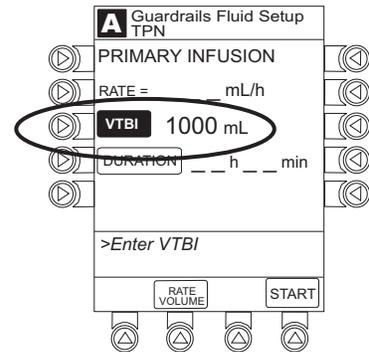

- Syringe Module:

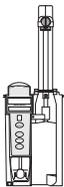

- If ALL Mode is enabled for syringe configuration in Data Set, **ALL** is displayed in **VTBI** field and estimated available volume in syringe is displayed.

OR

If ALL Mode is disabled for syringe configuration in Data Set, **VTBI ALL** option is not available and estimated available volume in syringe is displayed when **VTBI** soft key is pressed.

- To enter or change a numeric **VTBI** value, press **VTBI** soft key and use numeric data entry keys.
- To deliver entire contents of syringe: Keep an **ALL VTBI** value, or press **ALL** soft key to change a numeric **VTBI** value to **ALL**.

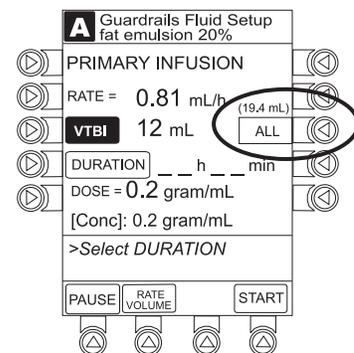
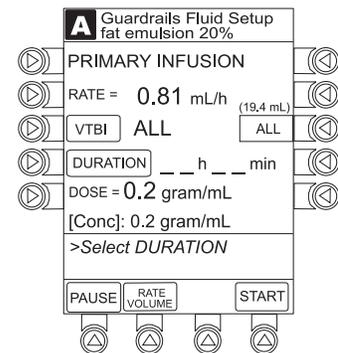

Primary Infusion - With Guardrails® Suite MX Protection (Continued)



IV Fluid Infusion (Continued)

Volume/Duration Infusion (Continued)

- To enter volume duration, press **DURATION** soft key and use numeric data entry keys.

Rate is automatically calculated.

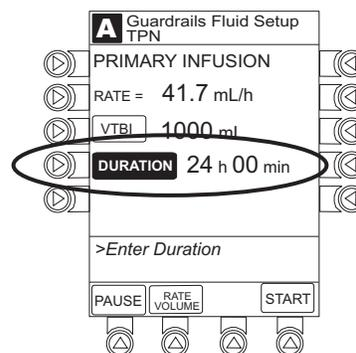

- Verify correct infusion parameter entry and press **START** soft key. ²
 - If programmed IV Fluid is outside Soft Limit for that care area, an audio alert sounds and a visual prompt appears before programming can continue. If **Yes** soft key is pressed, programming continues; if **No** soft key is pressed, infusion needs to be reprogrammed.
 - If programmed IV Fluid is outside Hard Limit for that care area, an audio alert sounds and a visual prompt appears before programming can continue. Infusion needs to be reprogrammed.
 - If a Soft Limit is overridden, **G** icon is displayed. When **G** soft key is pressed, all applicable out-of-range limits are listed.

- Syringe Module:

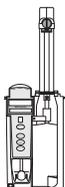

- Unclamp tubing and attach administration set to patient.
- Unclamping tubing and starting infusion before attaching administration set to patient minimizes any potential bolus that can be released from pressure built up in set due to normal syringe loading and priming.

Primary Infusion - With Guardrails® Suite MX Protection (Continued)

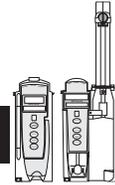

IV Fluid Infusion (Continued)

Volume/Duration Infusion (Continued)

NOTES:

- ① The infusion can be paused by pressing the **PAUSE** soft key. See "Pause, Change, Restart Infusion," "Pause and Restart Infusion" procedure.
- ② To view infusion **Time Left** during a volume/duration infusion, press **CHANNEL SELECT** key. To return to previous screen, press **START** soft key.

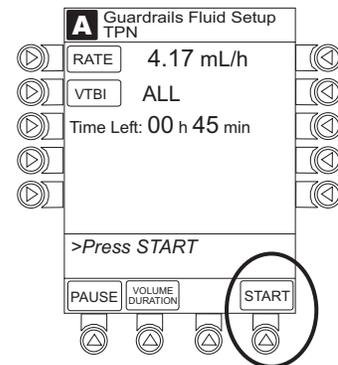

Secondary Infusion - With Guardrails® Suite MX Protection (Pump Module)



This mode is designed to support automatic secondary infusions ("piggybacking") in the same instrument. A secondary infusion can be programmed as a "Basic Infusion" or "Drug Library Infusion." When the secondary VTBI reaches zero, an audio tone sounds (if enabled) indicating completion of the secondary infusion. The primary infusion resumes automatically.

When the instrument is programmed and delivering in the secondary mode, the primary infusion is temporarily stopped and fluid is drawn from the secondary container. Delivery from the primary container resumes when the fluid level in the secondary line is level with the fluid in the primary container.

Setup

1. Open secondary administration set package, remove set and close clamp.
2. Insert administration set spike into prepared fluid container and hang secondary container, following accepted hospital/facility procedure.
3. Fill drip chamber to $\frac{2}{3}$ full.
4. Open secondary administration set clamp and prime set. Close clamp.
5. Attach secondary administration set to upper injection site on primary set.
6. Using hanger provided with secondary administration set, lower primary fluid container to height indicated in following illustrations.

WARNING

Secondary applications require the use of a **check valve set** on the primary IV line.

WARNING

The secondary administration set **must be primed** prior to beginning the secondary infusion.

WARNING

The **secondary solution container** must be higher than the primary solution container.

Secondary Infusion - With Guardrails® Suite MX Protection (Pump Module) (Continued)



Setup (Continued)

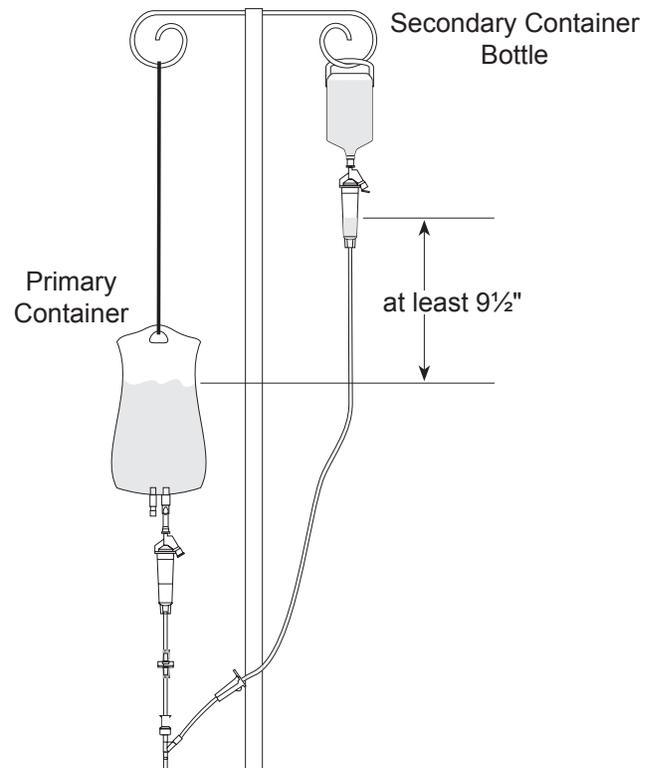
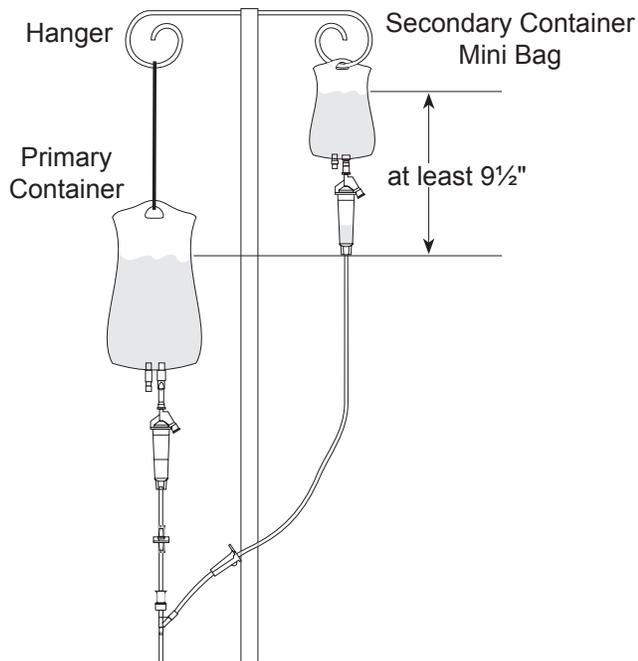

Infusion

The following procedure should be used only when:

- drug to be infused is listed in Drug Library,
- primary infusion is running, and
- a check valve administration set is being used.

To program a primary infusion, see "IV Fluid Infusion" procedure. To program a basic infusion, see "Infusion - NO Guardrails® Suite MX Protection" procedure.

1. Press **CHANNEL SELECT** key.

Secondary Infusion - With Guardrails® Suite MX Protection (Pump Module) (Continued)



Infusion (Continued)

2. Press **SECONDARY** soft key.

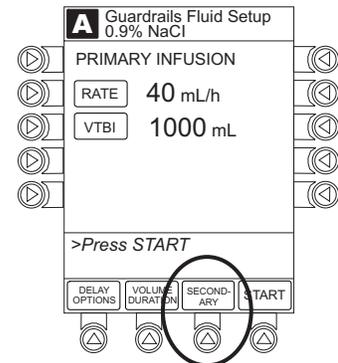

3. Press soft key next to desired drug.

- To view additional drugs, press a soft key next to a letter group to navigate through alphabet, and/or **PAGE UP** and **PAGE DOWN** soft keys.
- If applicable, an optional hospital-defined therapy or clinical indication for delivery of this infusion could appear. Different limits can be defined for same drug with different therapeutic indications.
- If applicable, a weight-based, non weight-based, or BSA-based option for delivery of this infusion could appear.
- If applicable, multiple concentration listings for delivery of this infusion could appear.

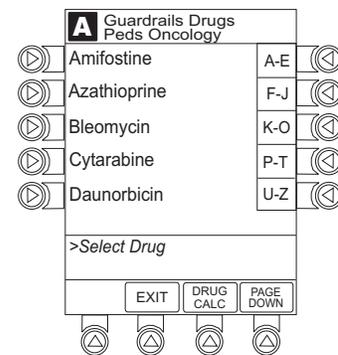

4. To continue programming, press **Yes** soft key. ^①

OR

To change selection, press **No** soft key.

- If **Yes** was selected and facility has defined a Clinical Advisory for that drug, a message appears. To indicate information has been noted and continue programming, press **CONFIRM** soft key.
- If **Yes** was selected to continue programming, drug amount and diluent volume (if defined in Drug Library) are automatically entered for selected drug.

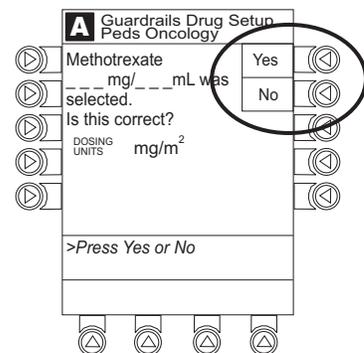

Secondary Infusion - With Guardrails® Suite MX Protection (Pump Module) (Continued)



Infusion (Continued)

- If selected drug had "__ / __ mL" concentration, drug amount and diluent volume need to be entered.
- If selected drug is not weight-based, **Not Used** is displayed in **PATIENT WEIGHT** field.
- If hospital/facility practice guidelines identify selected drug as weight-based, prompt for a patient weight in kilograms or BSA appears (as in illustrated example, which reflects use of Methotrexate).^②

A Guardrails Drug Setup Methotrexate	
DRUG AMOUNT	6840 mg
DILUENT VOLUME	20 mL
BSA	___ m ²
DOSE =	___ mg/m ²
[Conc]: 1.7 mg/mL	
>Enter BSA	
PRIMARY	DRUG LIBRARY

5. Verify correct parameters and press **NEXT** soft key to confirm.
 - If programmed total dose drug amount is outside Soft Limit for that care area, an audio alert sounds and a visual prompt appears before programming can continue. If **Yes** soft key is pressed, programming continues; if **No** soft key is pressed, infusion needs to be reprogrammed.
 - If programmed total dose drug amount is outside Hard Limit for that care area, an audio alert sounds and a visual prompt appears before programming can continue. Infusion needs to be reprogrammed.
 - If a dose outside of Soft Limits has been entered and verified as correct, Message Display also shows either "LLL" for a low dose or "^^^" for a high dose.
 - If a Soft Limit is overridden, **G** icon is displayed. When **G** soft key is pressed, all applicable out-of-range limits are listed.

Secondary Infusion - With Guardrails® Suite MX Protection (Pump Module) (Continued)



Infusion (Continued)

6. VTBI entry:

- When VTBI is less than 10 mL/h, entry can be to two decimal places (one-hundredth of a mL).
- VTBI is prepopulated with diluent volume of infusion. To change VTBI, press **VTBI** soft key and use numeric data entry keys.

WARNING

The **secondary VTBI settings** require consideration of such variables as factory overfill, medication additions. Underestimating the volume causes the remaining secondary solution to be infused at the primary rate; overestimating results in the primary solution being infused at the secondary rate. Multiple doses from a single container are not possible.

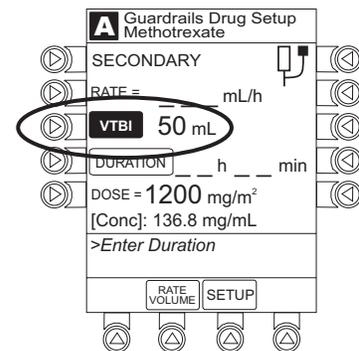

7. If an optional hospital-defined and editable starting value for intermittent duration is not already entered, enter duration or rate, as follows:

- To enter duration, press **DURATION** soft key and use numeric data entry keys (rate value is calculated and displayed).
- To enter rate, press **RATE VOLUME** soft key and use numeric data entry keys.

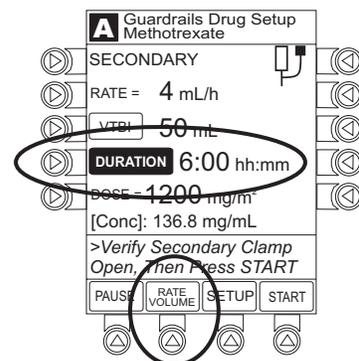

Secondary Infusion - With Guardrails® Suite MX Protection (Pump Module) (Continued)



Infusion (Continued)

8. Open clamp on secondary administration set.

9. Verify correct parameters and press **START** soft key.
 - If programmed duration is outside Soft Limit for that care area, an audio alert sounds and a visual prompt appears before programming can continue. If **Yes** soft key is pressed, programming continues; if **No** soft key is pressed, infusion needs to be reprogrammed.
 - If programmed duration is outside Hard Limit for that care area, an audio alert sounds and a visual prompt appears before programming can continue. Infusion needs to be reprogrammed.
 - If a Soft Limit is overridden, **G** icon is displayed. When **G** soft key is pressed, all applicable out-of-range limits are listed.

WARNING

The clamp on the secondary administration set must be opened. If the **clamp is not opened**, the fluid is delivered from the primary container.

NOTES:

- ① The facility can choose to prepopulate standard drug concentrations, or leave an open entry (_ _ / _ _ mL) and allow the clinician to enter the desired concentration.
- ② Once a patient weight or BSA is entered, for any module, it is automatically entered for any subsequent weight-based calculation.

Stop Secondary and Return to Primary

1. Press **CHANNEL SELECT** key.
2. Press **SETUP** soft key.
3. Press **PRIMARY** soft key.

Secondary Infusion - With Guardrails® Suite MX Protection (Pump Module) (Continued)



Stop Secondary and Return to Primary (Continued)

4. Close clamp on secondary administration set.
OR
Disconnect secondary administration set from upper injection port.
5. Press **START** soft key.
6. To stop secondary infusion and begin infusing primary, press **Yes** soft key. ^①
 - Secondary infusion stops and primary infusion begins.
 - Main screen appears.

NOTE:

- ① The SEC to PRI alert does not sound when the infusion is manually ended and returned to primary.

Infusion - NO Guardrails® Suite MX Protection

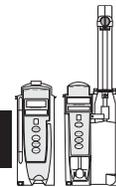

The following procedures should be used only when the drug to be infused is not listed in the Drug Library. When programming a drug not listed in the Drug Library, the drug calculation must be programmed using the **DRUG CALC** soft key within the Drug Library. There are no limits associated with any non-library drug calculation.

The illustrations in this procedure assume:

- ALL Mode (Syringe Module), Drug Calculation, Dynamic Pressure Display, Profiles, and Volume Duration configurable settings are enabled.
- NEOI (Syringe Module) and Delay Options configurable settings are disabled.

If Delay Options is enabled, the **PAUSE** soft key becomes **DELAY OPTIONS**.

1. Perform following steps (see PC Unit section of this DFU, "General Setup and Operation," "Start-Up"):
 - a. Power on system.

Infusion - NO Guardrails® Suite MX Protection (Continued)

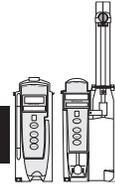

- b. Choose **Yes** or **No** to **New Patient?**
 - c. Confirm current profile or select a new profile.
 - d. Enter patient identifier, if required.
2. Prepare and load syringe/administration set (see "Getting Started").
 3. Prime (see "Getting Started").
 4. Start applicable infusion, as described in following procedures:

Basic Infusion
Continuous Infusion - Drug Calculation
Bolus Dose

Basic Infusion

The following procedure should be used only to set up a **Basic Infusion**. To program an infusion using **Guardrails Drugs**, see "Primary Infusion - With Guardrails® Suite MX Protection."

1. Press **CHANNEL SELECT** key.
2. Press **Basic Infusion** soft key.
Infusion Setup screen appears.
3. Start applicable infusion, as described in following procedures (see "Primary Infusion - With Guardrails® Suite MX Protection," "IV Fluid Infusion" procedure).

Rate/Volume Infusion
Volume/Duration Infusion

WARNING

When the **pressure sensing disc is not being used** and an occlusion occurs, there is a risk of infusing pressurized buildup of infusates upon correction of the occlusion. To avoid an inadvertent bolus, relieve the pressure before restarting the infusion.



Infusion - NO Guardrails® Suite MX Protection (Continued)

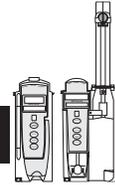

Promote Basic Infusion to Guardrails® Suite MX Protection Infusion

1. Press **CHANNEL SELECT** key on module running infusion to be promoted.
2. Press **OPTIONS** key.

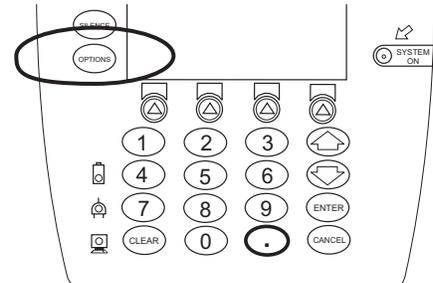

3. Press **Guardrails Drugs** soft key.
4. Continue programming (see "Primary Infusion - With Guardrails® Suite MX Protection").

Continuous Infusion - Drug Calculation

1. Press **Guardrails Drugs** soft key.
2. Press **DRUG CALC** soft key.

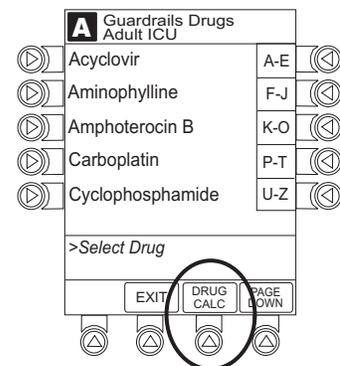

3. To enter **DRUG AMOUNT**, use numeric data entry keys.
4. Press soft key for appropriate unit of measure for drug amount.
5. To enter diluent volume, use numeric data entry keys.
6. Press **PATIENT WEIGHT** soft key.
7. To indicate whether or not patient weight is to be used in Drug Calculation, press either **Yes** or **No** soft key. ①

Infusion - NO Guardrails® Suite MX Protection (Continued)

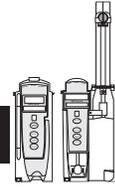

Continuous Infusion - Drug Calculation (Continued)

8. To enter patient weight (if required) in kilograms, use numeric data entry keys.
9. Press **TIME UNITS** soft key.
10. To select time base for drug calculation, press either **Min**, **Hour**, or **Day** soft key.
11. Press soft key next to desired **DOSING UNITS**.
12. Verify correct infusion parameters and press **NEXT** soft key.

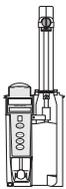

Syringe Module: If ALL Mode is enabled, **VTBI ALL** is displayed.

13. To make a rate or dose entry, press applicable soft key, **RATE** or **DOSE**, and use numeric data entry keys (other value is calculated and displayed).
14. To enter volume to be infused, press **VTBI** soft key and use numeric data entry keys.

- Pump Module:



- When VTBI is less than 10 mL/h, entry can be to two decimal places (one-hundredth of a mL).
- In Drug Calculation mode, system infuses at calculated rate rounded to nearest one-hundredth of a mL per hour (as displayed on programming screen). Rate shown in Rate Display is rounded to nearest one-tenth of a mL per hour.

- Syringe Module:

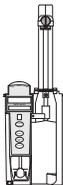

- If ALL Mode is enabled for syringe configuration in Data Set, **ALL** is displayed in **VTBI** field and estimated available volume in syringe is displayed.

OR

Infusion - NO Guardrails® Suite MX Protection (Continued)

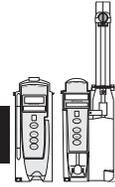

Continuous Infusion - Drug Calculation (Continued)

If ALL Mode is disabled for syringe configuration in Data Set, estimated available volume in syringe is displayed when **VTBI** soft key is pressed.

- To enter or change a numeric **VTBI** value, press **VTBI** soft key and use numeric data entry keys.
- To deliver entire contents of syringe: Keep an **ALL VTBI** value, or press **ALL** soft key to change a numeric **VTBI** value to **ALL**.
- **BOLUS** soft key appears only if Bolus Dose is enabled within selected profile, drug is bolusable, and a VTBI is entered.

15. Verify correct parameters and press **START** soft key.

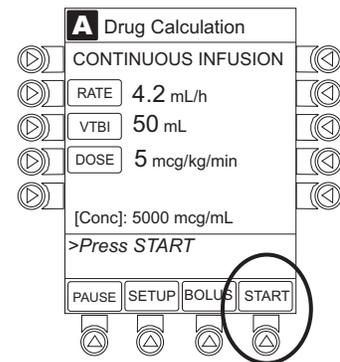

16. Syringe Module:

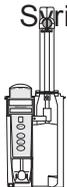

- Unclamp tubing and attach administration set to patient.
- Unclamping tubing and starting infusion before attaching administration set to patient minimizes any potential bolus that can be released from pressure built up in set due to normal syringe loading and priming.

NOTE:

- ① Do not enter a patient weight if weight is not used in the calculation.

Infusion - NO Guardrails® Suite MX Protection (Continued)

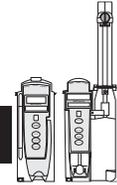

Bolus Dose

1. Set up infusion as described in "Continuous Infusion - Drug Calculation" procedure, but do not start infusion.
2. Press **BOLUS** soft key.
3. To enter bolus dose, use numeric data entry keys.

After a bolus dose and weight (if used) are entered, bolus VTBI and concentration [conc] alternate in Main Display.

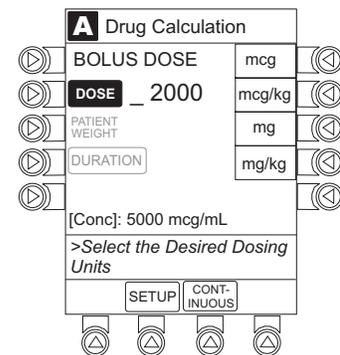

4. Press soft key next to appropriate unit of measure for dose.

If **mcg** or **mg** is selected as dosing unit, a **PATIENT WEIGHT** entry cannot be made. If **mcg/kg** or **mg/kg** is selected as dosing unit, a **PATIENT WEIGHT** entry is required.

5. To enter bolus duration, use numeric data entry keys.
TOTAL DOSE alternates with **INFUSE AT** rate.
6. Verify correct parameters and press **START** soft key.

To see details during bolus infusion, press **CHANNEL SELECT** key.

7. Syringe Module:

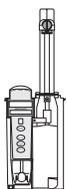

- If bolus dose was programmed at beginning of infusion, unclamp tubing and attach administration set to patient.
- Unclamping tubing and starting infusion before attaching administration set to patient minimizes any potential bolus that can be released from pressure built up in set due to normal syringe loading and priming.

Infusion - NO Guardrails® Suite MX Protection (Continued)

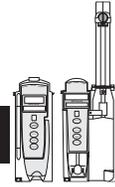

Bolus Dose (Continued)

Stop and Restore Bolus Dose

See "Primary Infusion - With Guardrails® Suite MX Protection," "Bolus Dose" procedure.

Secondary Infusion - NO Guardrails® Suite MX Protection (Pump Module)



See "Secondary Infusion - With Guardrails® Suite MX Protection" for a description of the secondary infusion mode and for setup instructions.

Infusion

The following procedure should be used only when:

- drug to be infused is not listed in Drug Library,
- primary infusion is running, and
- a check valve administration set is being used.

To program a primary infusion, see "Primary Infusion - With Guardrails® Suite MX Protection," "IV Fluid Infusion" procedure. To program a basic infusion, see "Infusion - NO Guardrails® Suite MX Protection."

1. Press **SECONDARY** soft key and then **BASIC SEC** soft key.
2. Enter secondary infusion rate or duration, as follows:
 - To enter secondary infusion rate, press **RATE** soft key and use numeric data entry keys.
 - To enter duration, press **DURATION** soft key and use numeric data entry keys.
3. To enter secondary volume to be infused, press **VTBI** soft key and use numeric data entry keys.
4. Open clamp on secondary administration set.
5. Verify correct infusion parameters and press **START** soft key.

Secondary Infusion - NO Guardrails® Suite MX Protection (Pump Module) (Continued)



Infusion (Continued)

Change Primary Infusion Parameter

1. Press **CHANNEL SELECT** key.
2. Press **PRIMARY** soft key.
3. To change primary infusion parameter, press applicable soft key (**RATE** or **VTBI**), and use numeric data entry keys.
4. Verify correct primary infusion parameters and press **SECONDARY** soft key.
Secondary setup screen is displayed.
5. To resume secondary infusion, press **START** soft key.

Stop Secondary and Return to Primary

See "Secondary Infusion - With Guardrails® Suite MX Protection."

Pause, Change, Restart Infusion

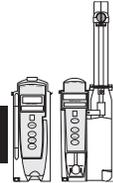

Pause and Restart Infusion ① ②

1. Press **PAUSE** key. ③
 - **PAUSE** scrolls in Message Display.
 - **PAUSED** appears on Main Display.
 - Yellow Standby Status Indicator illuminates.
 - After 2 minutes, **PAUSE-RESTART CHANNEL** visual and audio prompts begin, and yellow Standby Status Indicator flashes.

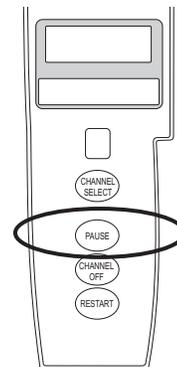

Pause, Change, Restart Infusion (Continued)

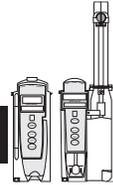

Pause and Restart Infusion (Continued) ① ②

- To reinitiate infusion:

Press **RESTART** key.

OR

Press **CHANNEL SELECT** key and then press **START** soft key.

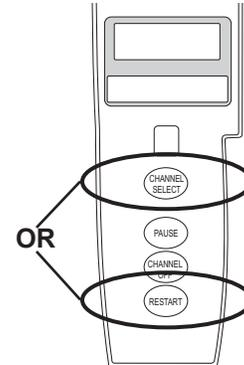

NOTES:

- ① To stop a Bolus Dose, see the "Bolus Dose" procedure.
- ② The Pump Module keypad is used in the illustrations but the keys are the same for the Syringe Module.
- ③ An infusion can also be paused by pressing the **PAUSE** soft key (on PC Unit), however, if an Alert has occurred, the system will not initiate the pause until the Alert has been addressed. To pause an infusion programmed with Delay Options, see "Delay Options," "Pause Infusion."

Change Rate or VTBI During Infusion

- Press **CHANNEL SELECT** key.
- Press either **RATE** or **VTBI** soft key.
- To enter desired parameter, use up/down arrows for rate titration, or numeric data entry keys.
- Verify correct infusion parameter entry and press **START** soft key.

Restore Infusion ①

- To restart infusion using stored parameters, press **RESTORE** soft key.
- Verify correct parameters and press **START** soft key.

NOTE:

- ① To restore a Bolus Dose, see the "Bolus Dose" procedure.

View and Clear Volume Infused

- To view volume infused, press **VOLUME INFUSED** soft key.

Total volume infused (primary + secondary), and time and date volume infused was last cleared, display for each module. ① ②

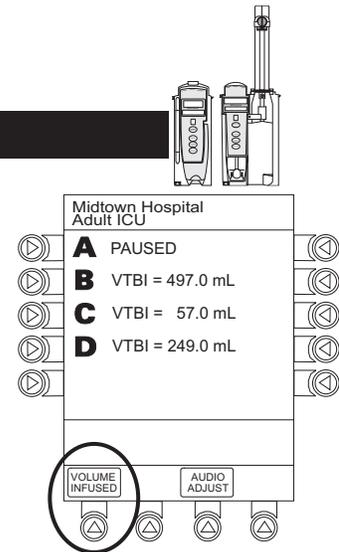

-  Pump Module: To view primary and secondary volume(s) infused, press **PRI/SEC VOLUME** soft key.

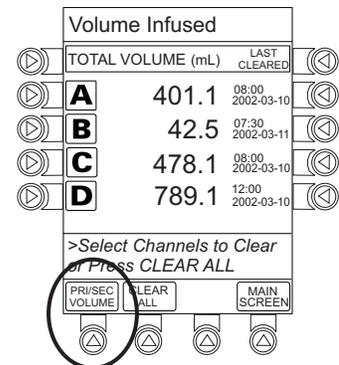

- To clear volume infused: ③ ④

- If only selected module is to be cleared, press soft key next to applicable module and press **CLEAR CHANNEL** soft key.

Volume clears on selected module.

- If all modules are to be cleared, press **CLEAR ALL** soft key.

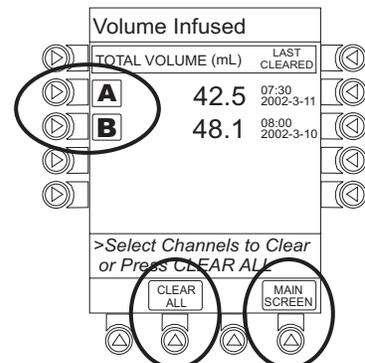

View and Clear Volume Infused (Continued)

- To return to main screen, press **MAIN SCREEN** soft key.

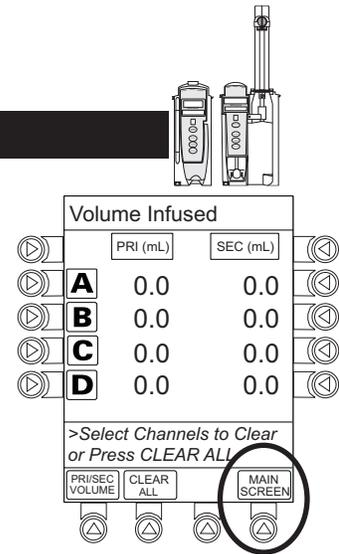

NOTES:

- ① Date format is year-month-day.
- ② Pump Module: A **PRI/SEC VOLUME** soft key is available to allow secondary volume infused to be displayed.
- ③ If no key is pressed, main screen appears after 30 seconds.
- ④ The illustrated example is a Syringe Module display. A Pump Module display has a **PRI/SEC VOLUME** soft key.

Channel Labels

The **Channel Labels** option is not available if a **Guardrails IV Fluids** or **Guardrails Drugs** infusion is running on the module. A channel label is removed when the **Basic Infusion** is promoted to a **Guardrails IV Fluids** or **Guardrails Drugs** infusion.

Select

1. Press **CHANNEL SELECT** key.
2. Press **OPTIONS** key.

Channel Labels (Continued)

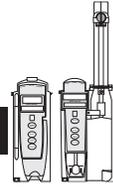

Select (Continued)

3. Syringe Module: Press **PAGE DOWN** soft key.

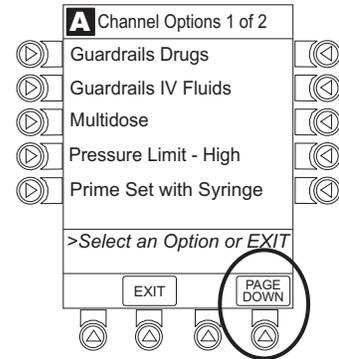

4. Press **Channel Labels** soft key.

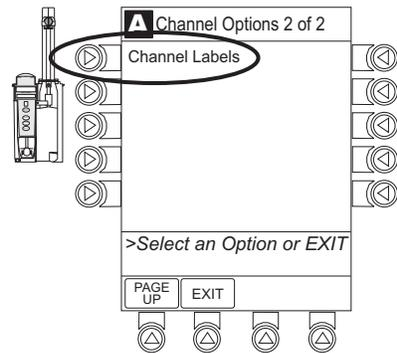
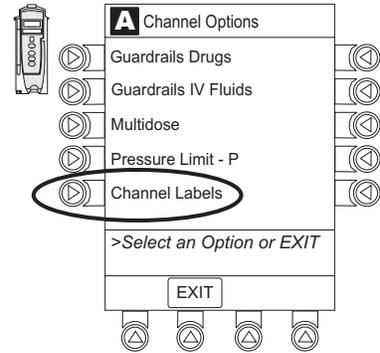

Channel Labels (Continued)

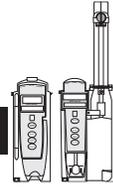

Select (Continued)

5. Press soft key for desired label. ①

Selected label is highlighted and scrolls in Message Display.

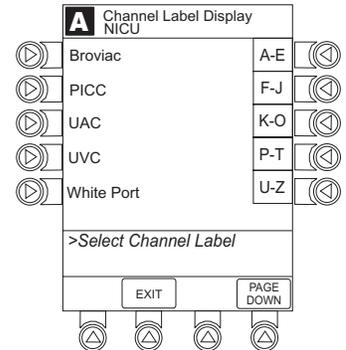

6. To continue infusion, press **START** soft key.

OR

Program infusion as previously described.

NOTE:

- ① To view additional labels, press a soft key next to a letter group to navigate through the alphabet, and/or **PAGE UP** and **PAGE DOWN** soft keys.

Remove

1. Press **CHANNEL SELECT** key.
2. Press **OPTIONS** key.
3. Syringe Module: Press **PAGE DOWN** soft key.

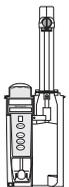

4. Press **Channel Labels** soft key.

Channel Labels (Continued)

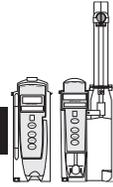

Remove (Continued)

5. Press **CLEAR LABEL** soft key.
Label stops scrolling in Message Display.

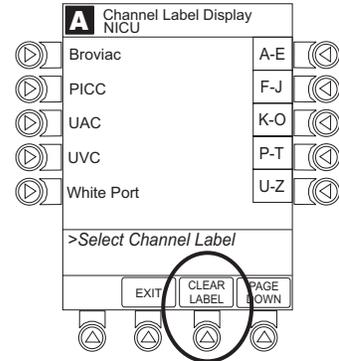

6. To begin infusion, press **START** soft key.
OR
Program infusion as previously described.

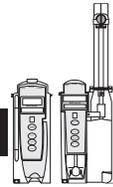

Anesthesia Mode

See the PC Unit section of this DFU.

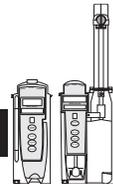

Delay Options

Delay Options can be enabled at the time the Alaris® System is configured for use. If Delay Options is enabled, a primary infusion can be programmed to be delayed for a specified period of time and a callback can be scheduled, as described in the following procedures.

Since by definition, an infusion with Delay Options infuses for a programmed period of time, it is assumed that another infusing IV line keeps the vein open until the delayed infusion begins. When a delay is programmed, the infusion stops when complete and no KVO is delivered.

Delay Options (Continued)

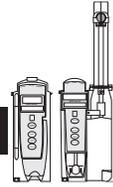

Delay Infusion

The delay period for an infusion can be programmed as a specific number of minutes or a time of day, as described in the following procedures. An infusion delay can be programmed prior to or after an infusion is initiated.

Specify by Minutes

The **Delay for** option is used to program an infusion delay for a minimum of 1 minute and up to 120 minutes.

1. Press **DELAY OPTIONS** soft key.

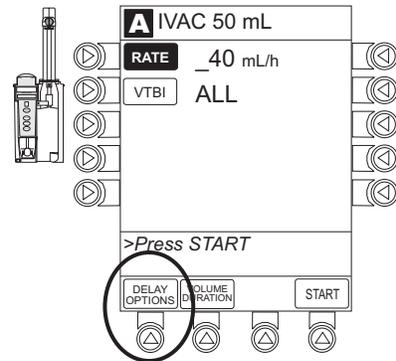
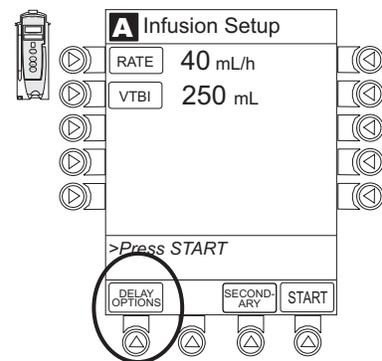

Delay Options (Continued)

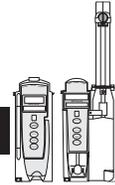

Delay Infusion (Continued)

Specify by Minutes (Continued)

2. Press **Delay for** soft key.

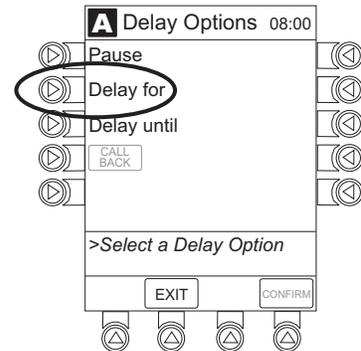

3. To enter number of minutes (up to 120) infusion is to be delayed for, use numeric data entry keys.
4. Press **CONFIRM** soft key.
 - Delay period counts down on Main Display.
 - If a **Before** callback has not been scheduled (see "Schedule a Callback" procedure), infusion automatically initiates at end of delay period.

Specify by Time of Day

The **Delay until** option is used to program an infusion delay for a minimum of 1 minute and up to 23 hours 59 minutes.

1. Press **DELAY OPTIONS** soft key.
2. Press **Delay until** soft key.

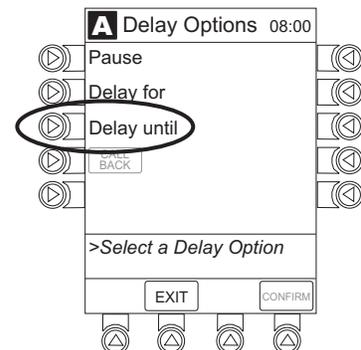

Delay Options (Continued)

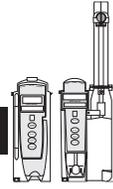

Delay Infusion (Continued)

Specify by Time of Day (Continued)

- If **Current time** displayed is correct, press **CONFIRM** soft key; otherwise, press **Change Time** and enter correct time. (See "System Options," "Time of Day" in PC Unit section of this DFU.) ①

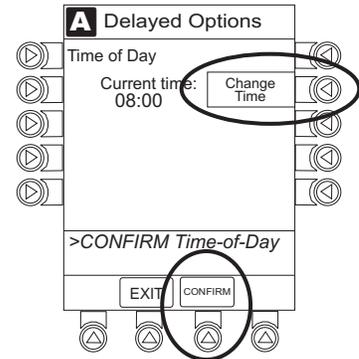

- To enter time of day infusion is to be initiated (up to 23 hours 59 minutes), use numeric data entry keys.
- Press **CONFIRM** soft key.
 - Time infusion is scheduled to start appears on Main Display.
 - If a **Before** callback has not been scheduled (see "Schedule a Callback" procedure), infusion automatically initiates at end of delay period.

NOTE:

- ① If the current time has been previously confirmed, the **Time of Day** screen does not display.

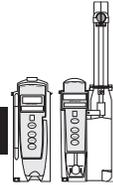

Delay Options (Continued)

Schedule a Callback

When programming a **Delay for** or **Delay until** infusion, a callback can be scheduled for that infusion. There are three types of callback:

- **Before** - gives an alert when delay period is completed and infusion needs to be initiated.
- **After** - gives an alert when delayed infusion has completed.
- **Before and After** - gives an alert when delay period is completed and infusion needs to be initiated and when delayed infusion has completed.

The default callback (**None**), or the callback for the current profile, appears on the Main Display. To schedule a different callback:

1. Prior to pressing **CONFIRM** soft key to initiate delay during **Delay for** or **Delay until** programming process, press **CALL BACK** soft key.
2. Press soft key corresponding to desired callback option. Scheduled callback appears on Main Display.
3. To initiate delay, press **CONFIRM** soft key.
 - If **Delay until** programming, time infusion is scheduled to start appears on Main Display.

OR

If **Delay for** programming, delay period counts down on Main Display.

- If **Before** option was selected:
 - An audio prompt sounds when delay period has ended.
 - Yellow Standby Status Indicator flashes.
 - **DELAY COMPLETE** scrolls in Message Display and appears on Main Display.

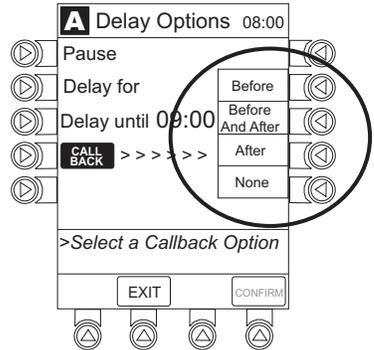

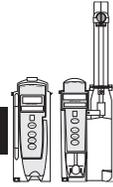

Delay Options (Continued)

Schedule a Callback (Continued)

- If **After** option was selected:
 - An audio prompt sounds when delayed infusion completes, and continues to sound until responded to.
 - Yellow Standby Status Indicator flashes until audio is silenced.
 - Infusion completed message appears on Main Display.
 - **Infusion Complete** scrolls in Message Display.
 - If **Before and After** option was selected, same prompts and indicators mentioned above for both **Before** and **After** options are exhibited.
4. To respond to a callback:
- **Before** callback:
Press **CHANNEL SELECT** key and then **START** soft key.

OR

 - Press **RESTART** key.
- **After** callback: Press **CONFIRM** soft key.
 - **Before and After** callback: Respond as indicated above for both **Before** and **After**.

Pause Infusion

1. Press **DELAY OPTIONS** soft key.
 2. Press **Pause** soft key. ①
- If an Alert has occurred, pause is not initiated by system until Alert is addressed.

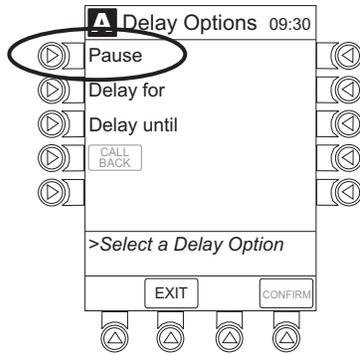

Delay Options (Continued)

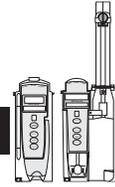

Pause Infusion (Continued)

3. Press **CONFIRM** soft key.
 - **PAUSE** scrolls in Message Display.
 - **PAUSED** appears on Main Display.
 - Yellow Standby Status Indicator illuminates.
 - After 2 minutes: **PAUSE - RESTART CHANNEL** visual and audio prompts begin, and yellow Standby Status Indicator flashes.
4. To reinitiate infusion:
Press **RESTART** key.
OR
Press **CHANNEL SELECT** key and then **START** soft key.

NOTE:

- ① The time displayed in the upper right corner of the screen is the time of day in a 24-hour clock format (military time).

Multidose Mode

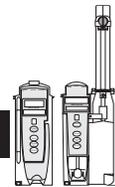

Since, by definition, a multidose infusion does not infuse for a programmed period of time, it is assumed that another infusing IV line keeps the vein open until the beginning of the first dose and between subsequent doses. There is no keep vein open (KVO) infusion at the completion of a programmed **Delay until** infusion.

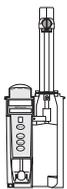

Syringe Module: ALL Mode is not supported in Multidose Mode.

WARNINGS

- The Multidose feature is to be used only by **personnel properly trained** in using multidose infusions.
- **Caution labels**, which clearly differentiate single dose and multidose containers, must be utilized.
- Single dose piggybacking systems employing **check valve sets** are not designed for use with multidose containers.



Multidose Mode (Continued)

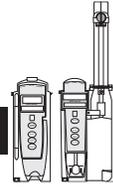

The Delay Options function for multidose infusions is similar to Delay Options for continuous drug infusions, with the following differences:

- **Delay for** option (when scheduling a callback) is not available in Multidose Mode.
- Maximum allowable delay on a multidose infusion is 8 hours.

1. Press **CHANNEL SELECT** key.
2. Press **OPTIONS** key.
3. Press **Multidose** soft key.

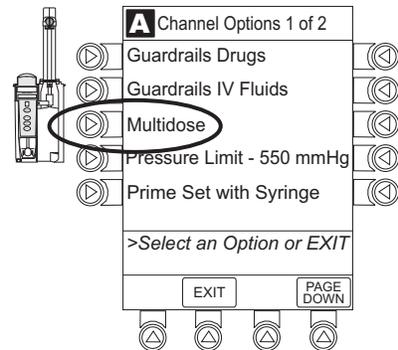
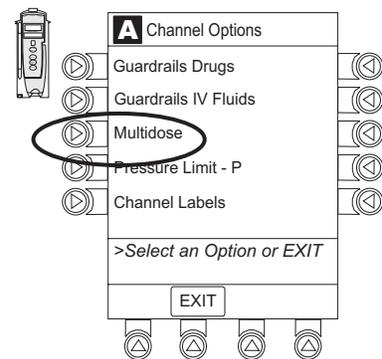

4. Start applicable infusion, as described in following procedures:

Volume/Duration Enabled
Volume/Duration Disabled

Multidose Mode (Continued)



Volume/Duration Enabled

1. If **Current time** displayed is correct, press **CONFIRM** soft key; otherwise, press **Change Time** and enter correct time. (See "System Options," "Time of Day" in PC Unit section of this DFU.)^①

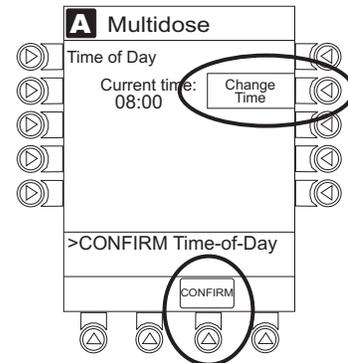

2. Press **VOLUME DURATION** soft key.
3. To enter volume to be infused for each dose, use numeric data entry keys.
4. To enter duration for each dose, press **DURATION** soft key and use numeric data entry keys.^②
5. To enter time interval (1 to 24 hours) between doses, press **DOSE INTERVAL** soft key and use numeric data entry keys.
6. To enter number of doses, press **# OF DOSES** soft key and use numeric data entry keys.

If Delay Options is enabled, **DELAY OPTIONS** soft key appears.^③

7. To begin multidose infusion, press **START** soft key.
 - Main Display shows remaining VTBI for that dose.
 - At completion of a multidose program, **MULTIDOSE COMPLETE** appears on Main Display.^④

8. Syringe Module:



- Unclamp tubing and attach administration set to patient.
- Unclamping tubing and starting infusion before attaching administration set to patient minimizes any potential bolus that can be released from pressure built up in set due to normal syringe loading and priming.

Multidose Mode (Continued)

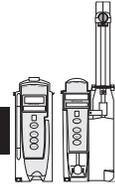

Volume/Duration Enabled (Continued)

9. To see detail screen during or between infusions, press **CHANNEL SELECT** key.
 - During infusion, **Volume Remaining** is displayed.
 - Between infusions:
 - Number of doses completed and when next dose starts display.
 - Yellow Standby Status Indicator illuminates.

NOTES:

- ① If the current time has been previously confirmed, the **Time of Day** screen does not display.
- ② **RATE** is calculated with each keystroke for **DURATION**.
- ③ See "Delay Options" procedure to program an infusion delay. When delaying an infusion, a multidose cannot be delayed for more than 8 hours, and all doses in the multidose program must be completed within a 24-hour program.
- ④ Syringe Module: If NEOI is enabled, the Near End of infusion message appears near the end of the last dose.

Volume/Duration Disabled

1. To enter rate, use numeric data entry keys.
2. To enter volume to be infused for each dose, press **VOLUME/DOSE** soft key and use numeric data entry keys.
3. To enter time interval (1 to 24 hours) between doses, press **DOSE INTERVAL** soft key and use numeric data entry keys.
4. To enter number of doses, press **# OF DOSES** soft key and use numeric data entry keys.

If Delay Options is enabled, **DELAY OPTIONS** soft key appears. ①
5. To begin multidose infusion, press **START** soft key.
 - Main Display shows remaining VTBI for that dose.
 - At completion of a multidose program, **MULTIDOSE COMPLETE** appears on Main Display. ②

Multidose Mode (Continued)



Volume/Duration Disabled (Continued)

6.  Syringe Module:
- Unclamp tubing and attach administration set to patient.
 - Unclamping tubing and starting infusion before attaching administration set to patient minimizes any potential bolus that can be released from pressure built up in set due to normal syringe loading and priming.
7. To see detail screen during or between infusions, press **CHANNEL SELECT** key.
- During infusion, **Volume Remaining** is displayed.
 - Between infusions:
 - Number of doses completed and when next dose starts are displayed.
 - Yellow Standby Status Indicator illuminates.

NOTES:

- ① See "Delay Options" procedure to program an infusion delay. When delaying an infusion, a multidose cannot be delayed for more than 8 hours, and all doses in the multidose program must be completed within a 24-hour program.
- ② Syringe Module: If NEOI is enabled, the Near End of infusion message appears near the end of the last dose.

Select Pressure Limit

Pump Module



1. Press **CHANNEL SELECT** key.
2. Press **OPTIONS** key.

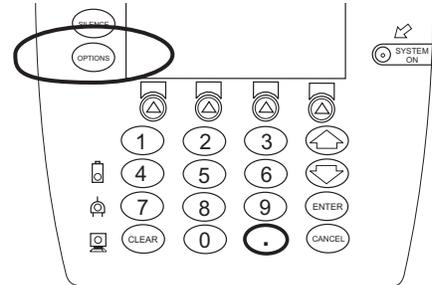

3. Press **Pressure Limit** soft key.

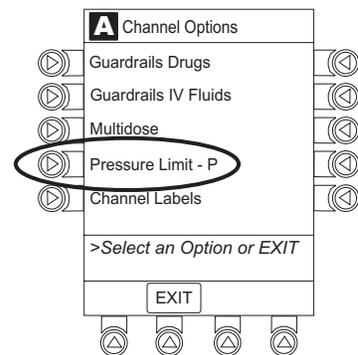

4. Press either **Pump** or **Selectable** pressure soft key. If **Selectable** is pressed, continue with next step; otherwise, proceed to last step.

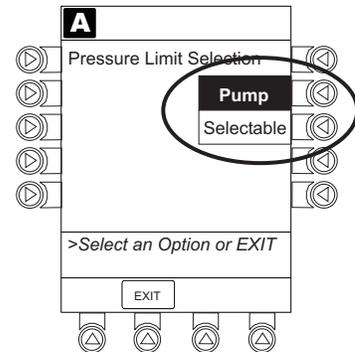

Select Pressure Limit (Continued)

Pump Module (Continued)



- To select occlusion pressure limit, press either **Up** or **Down** soft key.
- Verify correct occlusion pressure limit input and press **CONFIRM** soft key.

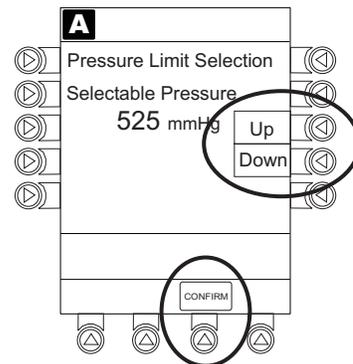

- Press **START** soft key.

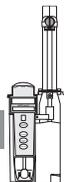

Syringe Module

Pressure Sensing Disc Installed

- Ensure that pressure sensing disc is installed correctly.
- Press **CHANNEL SELECT** key.
- Press **OPTIONS** key.

WARNING

Installing a pressure sensing disc after an infusion has started can result in a bolus to the patient.

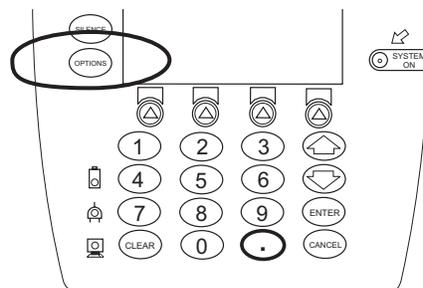

Select Pressure Limit (Continued)

Syringe Module (Continued)



Pressure Sensing Disc Installed (Continued)

- Press **Pressure Limit** soft key.

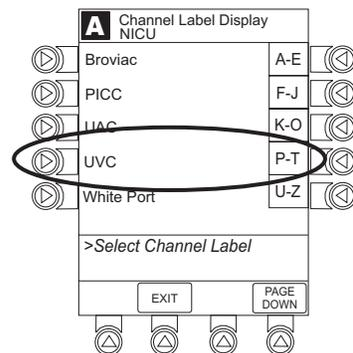

- To enter a new pressure limit value, press **Change Value** soft key. ^①

OR

If Auto Pressure feature is enabled, press **Auto Pressure** soft key. ^②

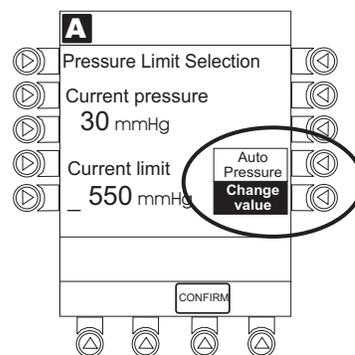

- Verify correct pressure limit input and press **CONFIRM** soft key.

Select Pressure Limit (Continued)

Syringe Module (Continued)



Pressure Sensing Disc Installed (Continued)

NOTES:

- ① The optimal occlusion alarm limit setting achieves a balance between the risk of false alarms and timely response to occlusions. To avoid interruptions in therapy, the limit should be set at a value higher than the expected actual "working" pressure, which will allow normal events such as patient movement and titrations to occur without alarms.

The "working" pressure presented to a pump by the IV cannula depends on several factors: combined rate of all infusions running into a single vascular access point, resistance of the fluid path, elevation differential, and vascular pressure dynamics. Resistance to flow is determined by the catheter's length and inner diameter, and the viscosity of the fluid. Kinking and clotting might also elevate the resistance to flow over time.

The Syringe Module allows both fixed and customized approaches to pressure limits to be configured. Each profile can be programmed with its own maximum pressure value, supporting a fixed limit approach. Customized limits can be set either manually, by reading the current pressure following stabilization and adding a margin, or by use of the Auto Pressure feature which, on activation, sets a margin of 30 mmHg for initial pressures under 100 mmHg or 30% of the initial pressure at higher initial values. The margin must be larger when variations in flow, resistance, and vascular pressure are anticipated. When pumping through high resistance access devices such as central line catheters, the Auto Pressure margin might be inadequate. With these devices, ten minutes or more might be required to allow the pressure to stabilize following flow rate changes, as required for the use of Auto Pressure. Therefore, caution should be used when using Auto Pressure for life sustaining fluids, to prevent unexpected interruptions of infusion due to occlusion alarms.

- ② If Auto Pressure is selected and current pressure is:
- 100 mmHg or less – system adds 30 mmHg to current pressure to create a new alarm limit
 - greater than 100 mmHg – system adds 30% to current pressure to create a new alarm limit

Select Pressure Limit (Continued)

Syringe Module (Continued)



Pressure Sensing Disc NOT Installed

1. Press **CHANNEL SELECT** key.
2. Press **OPTIONS** key.
3. Press **Pressure Limit** soft key.

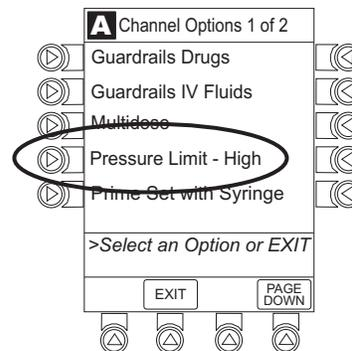

4. To select a pressure limit, press appropriate soft key.
5. Press **CONFIRM** soft key.

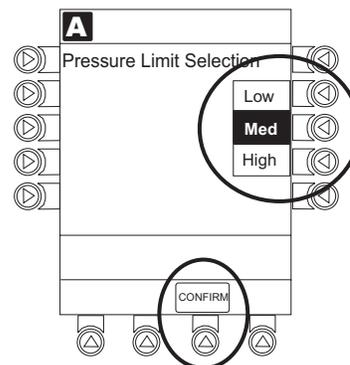

System Start-Up/Setup

See the PC Unit section of this DFU, "General Setup and Operation," for various system start-up and setup procedures.

Set Up for Gravity Infusion (Pump Module)



1. Prime administration set (see "Getting Started," "Prime" procedure).
2. Adjust container to hang 20 inches above patient's vascular access device.
3. Attach administration set to patient's vascular access device.
4. Adjust flow rate with administration set roller clamp.

Change Solution Container (Pump Module)



1. To stop infusion, press **PAUSE** key.
2. Close roller clamp.
3. Remove empty solution container.
4. Insert administration set spike into prepared fluid container, following accepted hospital/facility procedure, and hang container 20 inches above Pump Module.
5. Press **CHANNEL SELECT** key.
6. To enter VTBI, press **VTBI** soft key and use numeric data entry keys.
7. Open roller clamp.
8. To resume infusion, press **START** soft key.

System Start-Up/Setup (Continued)

Change Syringe During Infusion (Syringe Module)



If a critical medication is being infused at a flow rate less than 1.0 mL/h and the patient is not stable enough to experience even a short period of time without the drug, it is recommended that the new syringe and administration set be installed as part of a second Alaris® System setup. Before changing the infusion line at the patient end, start the infusion and wait for fluid to drip from the end of the tubing.

1. To stop infusion, press **PAUSE** key.
2. Open plunger grippers and syringe barrel clamp.
 - An audio prompt sounds—to silence, press **SILENCE** key.
 - Red Alarm Status Indicator flashes.
 - **CHECK SYRINGE** scrolls in Message Display.

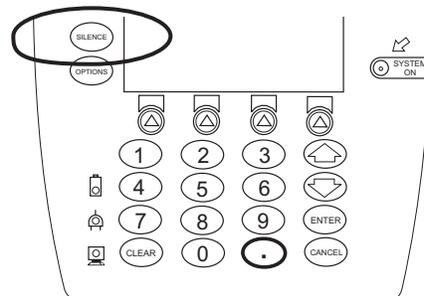

3. Remove syringe and separate administration set from syringe.
4. Reattach administration set to new syringe and load new syringe (see "Getting Started," "Prepare Syringe and Administration Set").
5. Select syringe type and size (see "Programming," "Primary Infusion - With Guardrails® Suite MX Protection").
6. Press **CONFIRM** soft key.
7. Prime administration set using options menu or manually (see "Getting Started," "Prepare Syringe and Administration Set").
8. Press **RESTORE** soft key.
OR
To enter VTBI and rate, press **RATE** soft key and use numeric data entry keys, and then **VTBI** soft key and use numeric data entry keys.
9. To begin infusion, press **START** soft key.

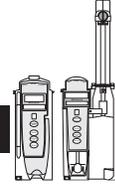

Warnings and Cautions

General

WARNINGS

- The Pump and Syringe Modules are designed to **stop fluid flow under alarm conditions**. Periodic patient monitoring must be performed to ensure that the infusion is proceeding as expected. It is a **positive displacement delivery system**, capable of developing positive fluid pressures to overcome widely varying resistances to flow encountered in practice, including resistances to flow imposed by small gauge catheters, filters and intra-arterial infusion. It is neither designed nor intended to detect infiltrations and does not alarm under infiltration conditions.
- The use of positive displacement infusion devices ported together with **gravity flow infusion** systems into a common IV site can impede the flow of common "gravity only" systems, affecting their performance. Hospital/facility personnel must ensure that the performance of the common IV site is satisfactory under these circumstances.
- To prevent a **potential free-flow condition**, ensure that no extraneous object (for example, bedding, tubing, glove) is enclosed or caught in the Pump Module door.



Administration Sets

WARNINGS

- **When priming:**
 - Ensure that administration set is not connected to patient.
 - Ensure that air is expelled from line prior to beginning infusion (unexpelled air in line could have serious consequences).

Failure to prime correctly can delay infusion delivery and cause the total volume to be infused to read higher than the actual total delivered to the patient.

- **Discard if** packaging is not intact or protector caps are unattached.

Warnings and Cautions (Continued)

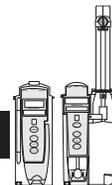

Administration Sets (Continued)

WARNINGS

- Use only **Pump Module/Gemini Infusion System administration sets** with the Pump Module. The use of any other set can cause improper instrument operation, resulting in an inaccurate fluid delivery or other potential hazard. For a list of compatible sets, refer to the Set Compatibility Card (provided separately). 
- Use only standard, single-use, disposable syringes with L-Lock connectors, and administration sets designed for use on syringe pumps. The use of any other syringe or administration set can cause improper instrument operation, resulting in an inaccurate fluid delivery or pressure sensing, or other potential hazards. ① 
- **Before loading or unloading the syringe**, always turn off fluid flow to the patient, using the tubing clamp or stopcock. Uncontrolled fluid flow can occur when the administration set is not clamped or turned off, and can cause serious injury or death. 
- When the **pressure sensing disc is not being used** and an occlusion occurs, there is a risk of infusing pressurized buildup of infusates upon correction of the occlusion. To avoid an inadvertent bolus, relieve the pressure before restarting the infusion. 
- Ensure that the displayed **syringe manufacturer and syringe size** correctly identify the installed syringe. Mismatches can cause an under-infusion or over-infusion to the patient that could result in serious injury and/or death. For a list of compatible syringes, see "Compatible Syringes." 
- **Installing a pressure sensing disc** after an infusion has started can result in a bolus to the patient. 

NOTE:

- ① For a list of compatible syringes, see "Compatible Syringes." For a list of compatible administration sets, refer to the Set Compatibility Card (available separately).

Warnings and Cautions (Continued)

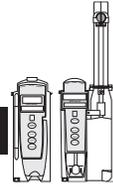

Administration Sets (Continued)

CAUTION

Before operating the instrument, verify that the administration set is **free from kinks and correctly installed**.

Epidural Administration

WARNINGS

- **Epidural administration** of drugs other than those indicated for epidural use could result in serious injury to the patient.
- It is strongly recommended that the source container, administration set, and Pump Module used for **epidural drug delivery** be clearly differentiated from those used for other types of administration. 
- It is strongly recommended that the syringe, administration set and Syringe Module used for **epidural drug delivery** be clearly differentiated from those used for other types of administration. 
- The Alaris® System can be used for epidural administration of **anesthetic and analgesic drugs**. This application is only appropriate when using anesthetics and analgesics labeled for continuous epidural administration and catheters intended specifically for epidural use. Use only a Pump Module/Gemini Infusion System administration set or syringe set, without a 'Y' connector or injection port, for epidural infusions.
 - Epidural administration of **anesthetic drugs**: Use indwelling catheters specifically indicated for short-term (96 hours or less) anesthetic epidural drug delivery.
 - Epidural administration of **analgesic drugs**: Use indwelling catheters specifically indicated for either short-term or long-term analgesic epidural drug delivery.

Warnings and Cautions (Continued)

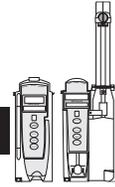

Guardrails® Suite MX

WARNINGS

- The **Guardrails® Suite MX** incorporates dosing limits and instrument configuration parameters based on hospital/facility protocol. The software adds a **test of reasonableness** to drug programming based on the limits defined by the hospital/facility. Qualified personnel must ensure the appropriateness of drug dosing limits, drug compatibility, and instrument performance, as part of the overall infusion. **Potential hazards** include drug interactions, inaccurate delivery rates and pressure alarms, and nuisance alarms.
- When loading a **Data Set** with the Guardrails® Suite MX, **ensure that the correct profile** (for patient care area) is selected prior to starting an infusion. Failure to use the appropriate profile could cause serious consequences.

Administration Set/Syringe Information

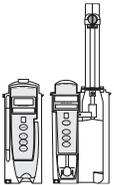

Infusion Modules:

- For specific administration set instructions and replacement interval, refer to directions for use provided with set.
- For a list of compatible administration sets, refer to Set Compatibility Card (provided separately).
- Use aseptic techniques when handling sets and syringes.
- Administration sets are supplied with a sterile and nonpyrogenic fluid path for one-time use. Do not resterilize.
- Discard administration set per facility protocol.
- For IV push medication (put instrument on hold), clamp tubing above port.
- Flush port(s) per facility protocol.

Administration Set/Syringe Information (Continued)



The Pump Module uses a wide variety of Pump Module/ Gemini Infusion System administration sets. The sets are designed for use with the Pump Module as well as for gravity-flow, stand-alone use.

- Primary set must be primed before use. It can be loaded into Pump Module to deliver a large volume infusion or it can be set up to deliver a gravity infusion.
- Safety clamp fitment (referred to on v9.0 PC Unit as "Flo-Stop") is a unique clamping device on the pumping segment that is part of all Pump Module/ Gemini Infusion System sets (see "Safety Clamp Fitment").



The Syringe Module uses standard, single-use, disposable syringes (with luer-lock connectors) and administration sets designed for use on syringe pumps. For a list of compatible syringes, see "Compatible Syringes."

SmartSite® Infusion Set (Pump Module)



1. Prior to every access, swab top of Needle-Free Valve port with 70% isopropyl alcohol (1 - 2 seconds) and allow to dry (approximately 30 seconds). ^①
2. Prime valve port. If applicable, attach syringe to Needle-Free Valve port and aspirate miniscule air bubbles.
3. Replace every 72 hours or after 100 activations, whichever occurs first. For infusions of blood, blood products or lipid emulsions, replace every 24 hours.

NOTE:

- ^① Dry time is dependent on area temperature, humidity and ventilation.

CAUTIONS

- If the Needle-Free Valve is **accessed by a needle** in an emergency, the valve will be damaged, causing leakage. Replace Needle-Free Valve immediately.
- The Needle-Free Valve is **contraindicated** for blunt cannula systems.
- Do not leave **slip luer syringes** unattended.

Administration Set/Syringe Information (Continued)

Safety Clamp Fitment (Pump Module) ①



The primary administration set's safety clamp fitment is a unique clamping device, on the pumping segment, that prevents inadvertent free-flow when the administration set is removed from the instrument.

Safety Clamp Fitment in Open Position

When a new Pump Module/Gemini Infusion System administration set is removed from the package, the safety clamp fitment is in the open position (white slide clamp aligned with blue fitment). In this open position, flow is not occluded but is allowed as required for the priming process. The roller clamp is used to control flow during the priming process.

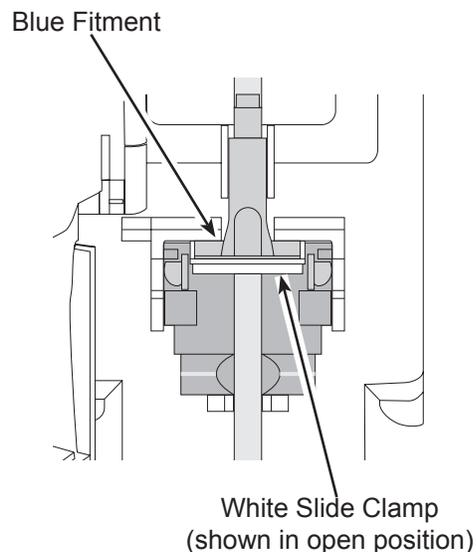

Safety Clamp Fitment in Closed Position

When a Pump Module/Gemini Infusion System administration set is removed from the Pump Module, the instrument automatically engages the safety clamp fitment in the closed position (white slide clamp projects out from under blue fitment). In this closed position, flow is occluded.

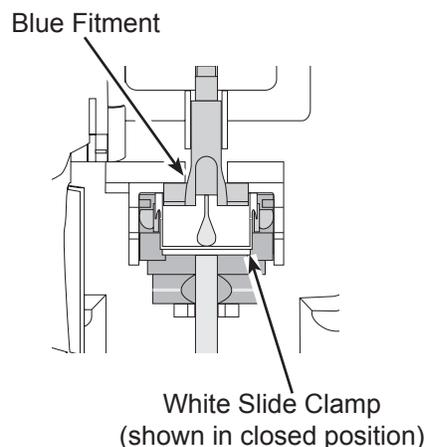

NOTE:

① "Safety clamp" is referred to on a v9.0 PC Unit as "Flo-Stop."

Administration Set/Syringe Information (Continued)

Compatible Syringes (Syringe Module)



The Syringe Module is calibrated and labeled for use with the following single-use disposable luer-lock syringes. Use only the syringe size and type specified on the Main Display. The full list of permitted syringe models is dependent on the Syringe Module's software version.

CAUTION

When using a **10 mL or smaller syringe**, CareFusion strongly recommends using an extension set with a pressure disc, for improved pressure monitoring and shorter times to occlusion alarm.

Manufacturer	1 mL	3 mL	5 mL	6 mL	10 mL	12 mL	20 mL	30 mL	35 mL	50 mL	60 mL
AstraZeneca										x ^①	x ^①
BD Plastipak	x	x	x		x		x	x		x	x
IVAC										x	
Monoject		x ^②		x		x	x		x		x
Terumo		x	x ^③			x ^③	x	x		x	x

NOTES:

- ① Prefilled Diprivan.
- ② The Monoject SoftPack Luer-Lock Syringe (blister pack) is the only currently supported Monoject 3 mL.
- ③ The Terumo 5 mL can also be used as a 6 mL and the 10 mL as a 12 mL.

Features and Displays

Features and Definitions

See the PC Unit section of this DFU for system features and definitions.

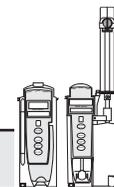

Feature	Definition—Pump and Syringe Modules
Anesthesia Mode	When operating in Anesthesia Mode, a module can be paused indefinitely without an alarm. Anesthesia Mode also makes it possible to have additional drugs in each profile, which are only accessible when operating in that mode.
Bolus Dose	Allows a bolus infusion to be programmed using either Drug Library or drug calculation feature. It can be programmed with or without a continuous infusion following a bolus.
Callback	A callback for a programmed delay (see "Delay Options" definition) can be scheduled to give an alert Before an infusion is to be initiated, After an infusion is completed, Before and After an infusion, or no alert (None).
Channel Labels	Available when Profiles feature is enabled. It provides a hospital-defined list of labels, displayed in Channel (module) Message Display, and identifies module with catheter location or other helpful information.
Concentration Limits	Limits specified for range of concentrations allowed for a particular drug in a profile.
Delay Options	Allows system to be programmed to delay start of an infusion a) for up to 120 minutes or b) for a specific time up to 23 hours 59 minutes.
Dose Checking	<p>Always Dose Checking option causes an Alert to occur each time a dose limit is exceeded. Drug label in Message Display provides an indicator ("↑↑↑" or "LLL") that dose is beyond current Soft Limit.</p> <p>Smart Dose Checking option causes an initial soft Alert to occur when a dose limit is exceeded. Subsequent programming beyond dose limit does not receive an Alert. Drug label in Message Display provides an indicator ("↑↑↑" or "LLL") that dose is beyond current Soft Limit.</p>
Drug Calculation	<p>Allows:</p> <ul style="list-style-type: none"> • entry of drug dose for a continuous infusion (Alaris® System calculates correct flow rate to achieve desired dose), <p style="text-align: center;">OR</p> <ul style="list-style-type: none"> • entry of flow rate for a continuous infusion (Alaris® System calculates corresponding drug dose).

Features and Displays (Continued)

Features and Definitions (Continued)

Feature	Definition—Pump and Syringe Modules
Drug Library	When Profiles feature is enabled, it provides a hospital-defined list of drugs and concentrations appropriate for use in as many as 10 profiles. Drug Library use automates programming steps, including drug name, drug amount and diluent volume, and activates hospital-established best-practice limits. Drug Library entries can be delivered as a primary or secondary, or both, as determined by hospital-health system.
Duration Limits	Hospital-established limits around duration of infusion.
Dynamic Pressure Display	Appears on Main Display. If enabled, it graphically displays current patient-side occlusion pressure set point and current patient-side operating pressure for that module. (See "Displays" for additional "Dynamic Pressure Display" information.)
Event Logging	Event Logging records instrument operations.
Initial Value	An optional and editable starting value for continuous infusion dose, duration, bolus dose, bolus rate of administration or bolus dose duration.
IV Fluid Library	An optional library consisting of IV Fluids (for example, TPN) and Limits around rate of delivery.
Limit	<p>A programming Limit or best-practice guideline determined by hospital/health system and entered into system's Data Set. Supports concentration Limits for all infusions that utilize concentration. Profile-specific Limits can be defined for flow rate, patient weight, body surface area (BSA), maximum and minimum continuous dose, or total dose and duration for each drug in a Drug Library. Dose and duration Limits can be defined by hospital/health system as Hard and/or Soft Limits.</p> <ul style="list-style-type: none"> • A Hard Limit is a programmed Limit that cannot be overridden, except in anesthesia mode. • A Soft Limit is a programmed Limit that can be overridden.
Multidose Mode	Allows 2 - 24 doses to be programmed at equally spaced intervals on the same module over a 24-hour period. This mode is designed to allow delivery of multiple, equal doses from the same IV container at regularly scheduled intervals.
Rapid Bolus	Fastest rate at which bolus dose should be delivered, as defined by facility's clinical best-practice guidelines.
Restore	To simplify programming, can be used to recall previous rate and volume settings for same patient. This option is only available if patient is not new and system is powered up within 8 hours of last usage.

Features and Displays (Continued)

Features and Definitions (Continued)

Feature	Definition—Pump and Syringe Modules
Therapies	An optional hospital-defined therapy or clinical indication for delivery of that infusion. Different Limits can be defined for same medication with different therapeutic indications.
Total Dose Limits	Hospital-established Limits around total dose of infusion.
Volume/Duration	Allows a volume-to-be-infused (VTBI) and duration (infusion time) to be programmed. Flow rate is automatically calculated.



Feature	Definition—Pump Module
Auto-Restart	<p>Part of Alaris® System's Downstream Occlusion Detection system designed to minimize nuisance, patient-side occlusion alarms. Allows system to automatically continue an infusion following detection of a patient-side occlusion if downstream pressure falls to an acceptable level within a 15-second "Checking Line" period. If this feature is enabled, "Checking Line" function occurs when downstream pressure exceeds pressure limit.</p> <ul style="list-style-type: none"> • In Selectable Pressure Mode: Pressure limit is either user-adjustable or "locked" in system configuration. • In Pump Pressure Mode: Pressure limit is a function of flow rate and is automatically determined by device. <p>If downstream pressure decreases to a predetermined level, (below 50% of pressure limit) during 15-second "Checking Line" period, infusion automatically continues. If condition is not cleared within 15 seconds, a "Partial Occlusion - Patient Side" alarm occurs.</p> <p>Using Editor Software, system can be configured to allow 0 (zero) to 9 restart attempts within a rolling 10 minute period. If allowable number of restarts is exceeded or if feature is set to zero, an "Occluded - Patient Side" alarm occurs when system detects downstream pressure that exceeds pressure limit.</p>
Default Occlusion Pressure	Starting occlusion pressure limit which can be configured by profile in 25 mmHg increments.

Features and Displays (Continued)

Features and Definitions (Continued)

Feature	Definition—Pump Module
Free Flow Protection	<p>All Pump Module/Gemini Infusion System administration sets utilize a unique clamping device (safety clamp^① on pumping mechanism) to prevent inadvertent free-flow when administration set is removed from instrument.</p> <hr/> <p>NOTE:</p> <p>① "Safety clamp" is referred to on a v9.0 PC Unit as "Flo-Stop."</p>
KVO Rate Adjust	<p>Used to select KVO (Keep Vein Open) rate (0.1 to 20 mL/h allowed), which is rate of fluid flow after an "Infusion Complete" occurs. KVO rate never exceeds infusion rate.</p>
Occlusion Pressure	<p>A complete range of downstream occlusion detection options is provided.</p> <ul style="list-style-type: none"> • Pump mode: Downstream occlusion alarm threshold is 525 mmHg at flow rates of 30 mL/h or greater. For rates less than 30 mL/h, occlusion pressure is rate-dependent to ensure rapid response to occlusions. • Selectable pressure mode: Downstream occlusion alarm threshold can be adjusted in 25 mmHg increments, up to maximum occlusion pressure of 525 mmHg. • Auto-Restart: (See "Auto-Restart" definition.) <p>In addition, Alaris[®] System provides fluid-side occlusion detection.</p>
Secondary Infusions	<p>Dual rate sequential piggyback (secondary) infusions can be infused, with limits, at delivery rates and volumes independent of primary infusion parameters. Automatic changeover occurs to primary infusion parameters when secondary infusion is complete if a Pump Module/Gemini Infusion System check valve administration set is used.</p>

Features and Displays (Continued)

Features and Definitions (Continued)



Feature	Definition—Syringe Module
All Mode	When ALL is selected as volume to be infused (VTBI), entire contents of syringe is delivered.
Auto Pressure	When enabled and a pressure sensing disc is in use, Auto Pressure option is displayed in Pressure Limit screen. Auto Pressure automatically sets alarm limit for a shorter time to alarm, as follows: <ul style="list-style-type: none"> • If current pressure is 100 mmHg or less, system adds 30 mmHg to current pressure to create a new alarm limit. • If current pressure is greater than 100 mmHg, system adds 30% to current pressure to create a new alarm limit.
Auto Pressure Limit Adjustment	When a bolus is delivered, pressure alarm limits are temporarily raised to maximum limit.
Auto Syringe Size Identification	System automatically detects syringe size and narrows down syringe selection list.
Back Off	This feature is only available when administration set in use has a pressure sensing disc. When enabled, motor reverses plunger movement during an occlusion until pressure returns to preocclusion levels, automatically reducing bolus flow.
Fast Start	When Fast Start is enabled and an administration set having a pressure sensing disc is used, instrument runs at an increased rate when an infusion is first started, taking up any slack in drive mechanism.
Infusion Complete	An alert is given when current infusion is complete and VTBI has reached zero.
Near End of Infusion (NEOI)	Allows an alert to be configured to sound anywhere from 1 to 60 minutes before infusion is complete. Alert occurs at configured time or when 25% of VTBI remains, whichever comes later.
Occlusion Pressure	A complete range of downstream occlusion detection options is provided. <ul style="list-style-type: none"> • With pressure sensing disc: Downstream occlusion alarm threshold is selectable between 25 and 1000 mmHg, in 1 mmHg increments. • Without pressure sensing disc: Downstream occlusion alarm threshold can be set to low, medium, or high.

Features and Displays (Continued)

Features and Definitions (Continued)

Feature	Definition—Syringe Module
Pressure Sensing Disc	When installed, pressure sensing disc significantly improves instrument's pressure sensing capabilities for a faster occlusion detection time, and makes following features available: Auto Pressure Back-Off Customizable Pressure Alarm Settings (see "Occlusion Pressure") Fast Start Pressure Tracking
Pressure Tracking	Dynamic current pressure display is only available when pressure sensing disc is inserted.
Priming	Allows a limited volume of fluid to be delivered in order to prime administration set prior to being connected to a patient or after changing a syringe. When priming, a single continuous press of PRIME soft key delivers up to 2 mL of priming fluid.
Selectable KVO	Allows some infusions to automatically switch into KVO mode upon completion. KVO option setting cannot be changed after instrument is powered on and a profile selected.
Syringe Empty	Instrument gives an alert and stops when an empty syringe is detected.
Syringe Volume Detection	System automatically detects fluid volume in a syringe when it is inserted.

Features and Displays (Continued)

Operating Features, Controls, Indicators

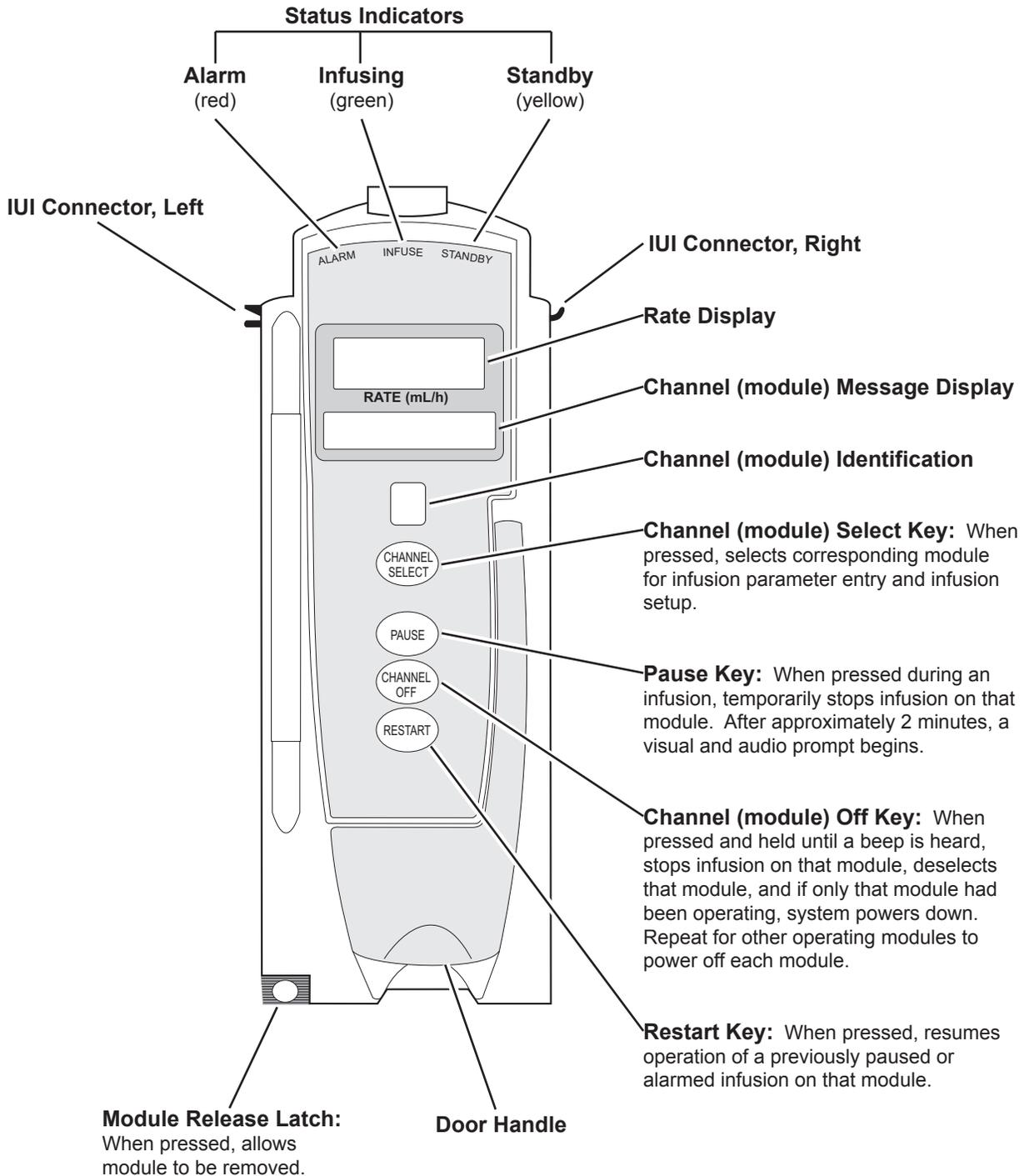

Features and Displays (Continued)

Operating Features, Controls, Indicators (Continued)

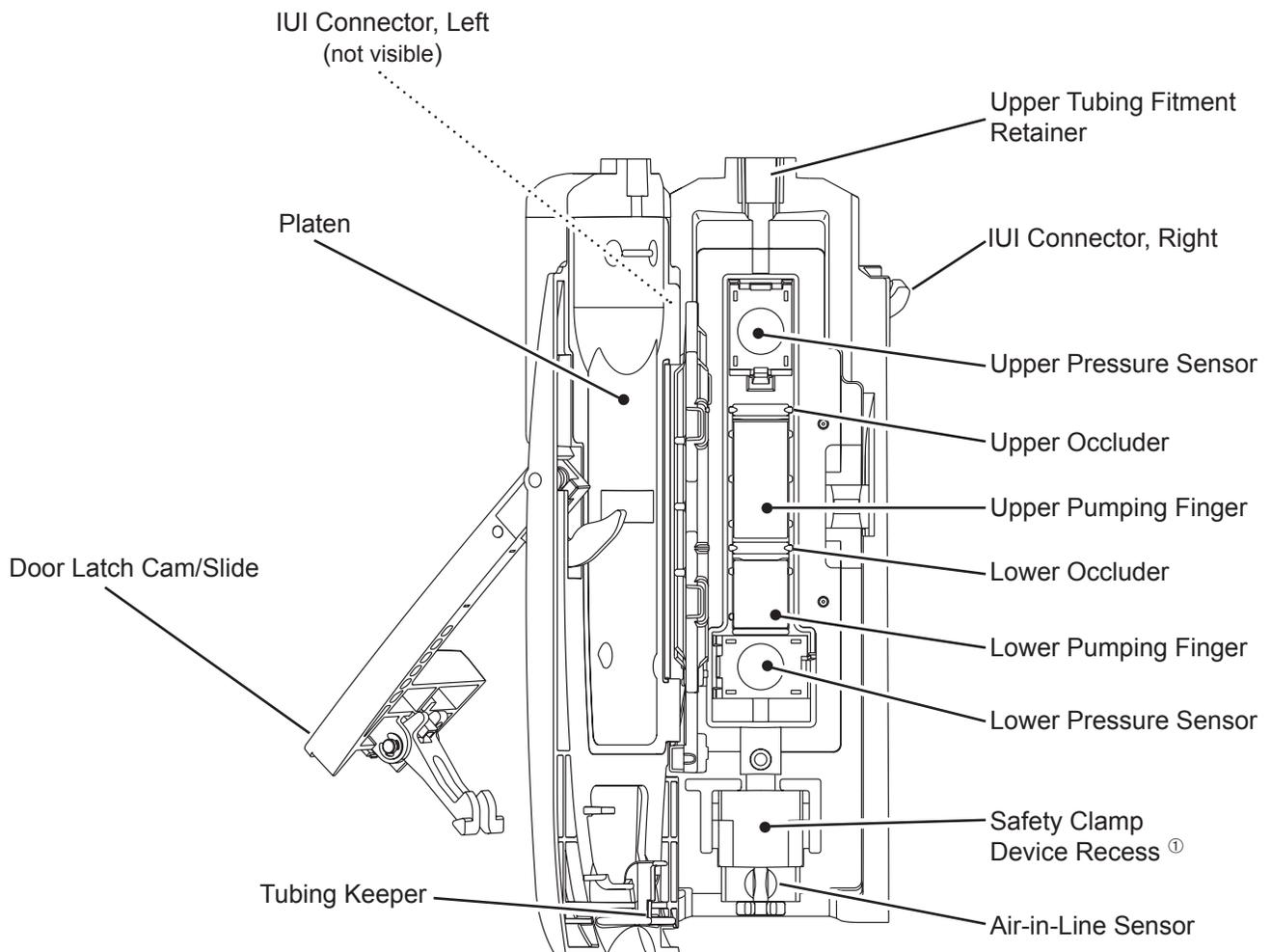

NOTE:

① "Safety clamp" is referred to on a v9.0 PC Unit as "Flo-Stop."

Features and Displays (Continued)

Operating Features, Controls, Indicators (Continued)

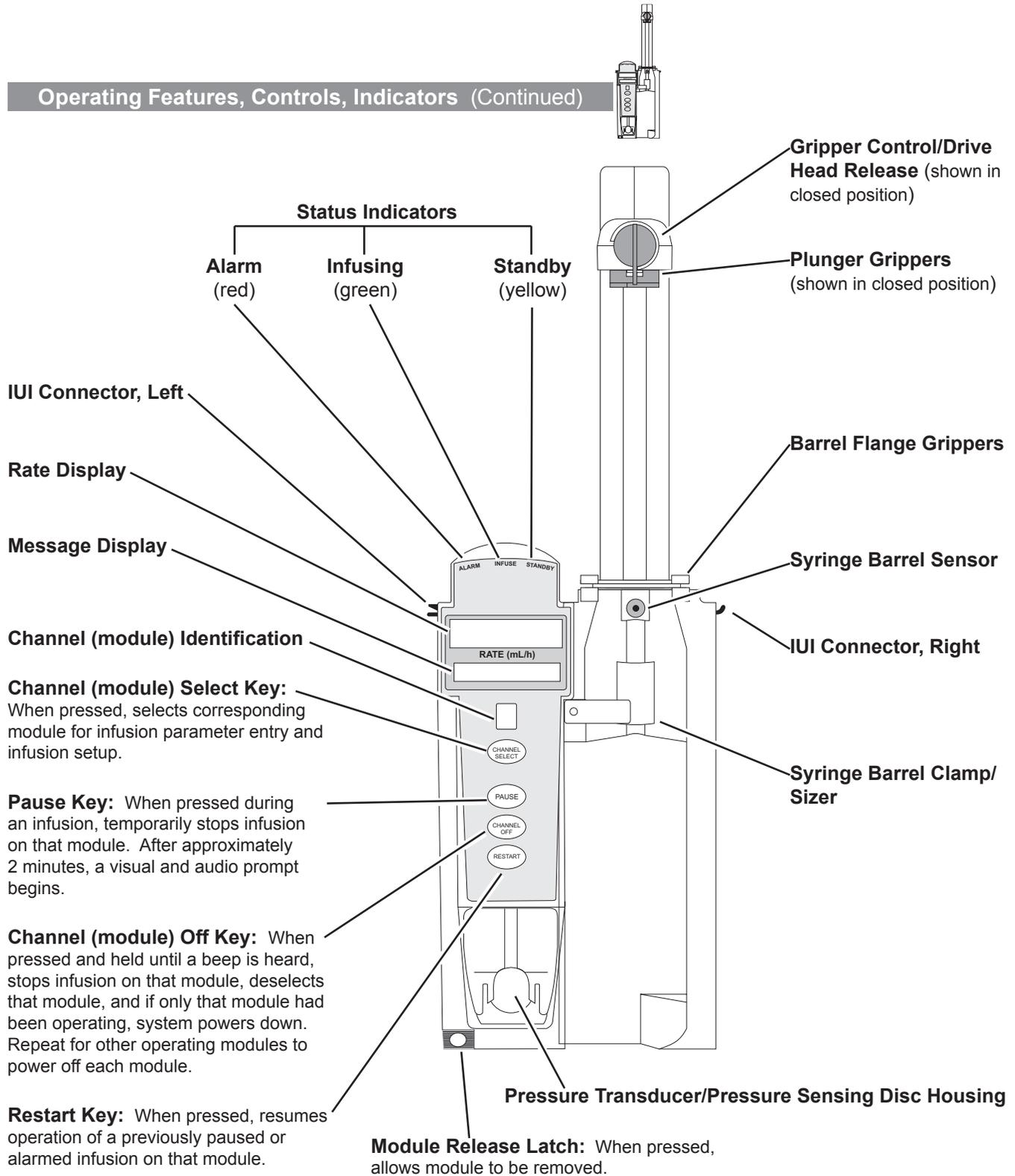

Features and Displays (Continued)

Displays

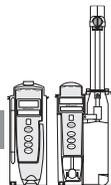

The displays illustrated throughout this document are for illustration purposes only. The display content varies, depending on configuration settings, type of administration set in use, hospital-defined Data Set uploaded using the Guardrails® Suite MX, programmed drug calculation parameters, and many other variables. Refer to specific drug product labeling for information concerning appropriate administration techniques and dosages.

Main Display

See the PC Unit section of this DFU.

Dynamic Pressure Display

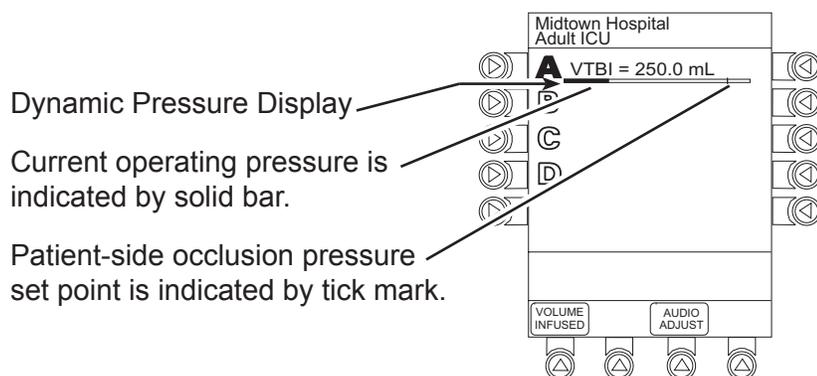

CAUTION

Although the dynamic pressure display bars for the Syringe Module and Pump Module both use the full width of the screen for display, they each **represent different ranges**. The Pump Module's range is 50 to 525 mmHg and the Syringe Module's range is 25 to 1000 mmHg.

Drug Calculation Definitions and Formulas

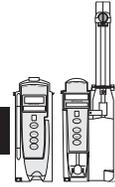

The Pump and Syringe Modules use the following parameters, entered during the drug calculation setup procedure:

- **Bolus dose duration:** Time period over which bolus dose is to be administered.
- **Bolus dose units:** Units used in calculating bolus dose. Bolus dose units are selected from alternatives provided.
- **Diluent volume:** Volume of fluid used as diluent for drug (mL).
- **Dosing units:** Units used to calculate continuous infusion drug dose. Dosing Units are selected from alternatives provided.
- **Drug amount:** Amount of drug in IV container (gram, mg, mcg, mEq, or units).
- **Patient weight:** Weight of patient (kg); this is an optional parameter that is not needed unless drug dose is normalized for patient weight.
- **Time units:** Time base for all calculations (minute, hour, or day).

The bolus dose, drug dose, and flow rate parameters are calculated using the above parameters, as follows:

- Bolus dose = bolus dose x patient weight (if used).
- Bolus dose administration rate (**INFUSE AT:**):
When duration is entered = total dose / duration in minutes.
When Max Rate is used = Max Rate / 60 x concentration.
- Bolus dose duration = bolus VTBI / bolus rate.
- Bolus dose VTBI = bolus dose / drug concentration.
- Bolus rate = bolus VTBI / duration.
- Continuous drug dose = flow rate x drug concentration (normalized for patient weight if specified by entering a patient weight).
- Continuous flow rate = drug dose / drug concentration (normalized for patient weight if specified by entering a patient weight).
- Duration = VTBI / rate.
- Drug concentration = drug amount / diluent volume.
- Rate = VTBI / duration.

WARNING

The Drug Calculation feature is to be used only by **personnel properly trained** in the administration of continuously infused medications. Extreme caution should be exercised to ensure that the correct entry of the drug calculation infusion parameters.

Drug Calculation Definitions and Formulas (Continued)

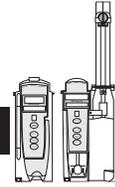

- Total bolus dose:
 Bolus dose not weight-based = bolus dose entered.
 Bolus dose weight-based = bolus dose x patient weight.
- Total dose:
 Drug amount.
 Drug amount / patient body surface area (BSA).
 Drug amount / patient weight.

Configurable Settings

See the PC Unit section of this DFU for system configurable settings.

If the configuration settings need to be changed from the **Factory default** settings, refer to the applicable Technical Service Manual or contact CareFusion Technical Support, for technical, troubleshooting, and preventive maintenance information.

With the Profiles feature enabled, the settings are configured independently for each profile. A hospital-defined, best-practice Data Set must be uploaded to enable the Profiles feature. Date and Time is a system setting and is the same in all profiles.

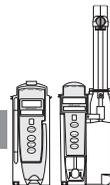

Shared Infusion

Feature	Default Setting	Options
Delay Options • Callback	Disabled None	Enabled - Disabled None, Before, After, Before and After
Drug Calculation • Bolus Dose	Disabled Disabled	Enabled - Disabled Enabled - Disabled
Multidose • Callback	Disabled None	Enabled - Disabled None, Before, After, Before and After
Pressure Dynamic (Dynamic Pressure Display)	Disabled	Enabled - Disabled
Volume/Duration	Disabled	Enabled - Disabled

Configurable Settings (Continued)

Pump Module



Feature	Default Setting	Options
Accumulated Air	Enabled	Enabled - Disabled
Air-in-Line Settings (single bolus)	75 mcL	50, 75 or 250 mcL Anesthesia Mode only: 500 mcL
Auto-Restart Attempts	0	0 - 9 attempts Anesthesia Mode only: 9 attempts
KVO (Keep Vein Open)	1 mL/h	0.1 - 20 mL/h
Max Rate	999 mL/h	0.1 - 99.9 mL/h in 0.1 mL/h increments; 100 - 999 mL/h in 1 mL/h increments
Max VTBI	9999 mL/h	0.1 - 9999 mL
Pressure Mode <ul style="list-style-type: none"> • Mode Selection • Lock Status • Max Occlusion Pressure • Default Starting Occlusion Pressure 	Pump Unlocked 525 mmHg 525 mmHg	Pump, Selectable Locked, Unlocked 50 - 525 mmHg in 25 mmHg increments (adjustable only in Selectable Pressure Mode) 50 - 525 mmHg in 25 mmHg increments (configured by profile and adjustable only in Selectable Pressure Mode)
SEC to PRI Alert	Enabled	Enabled - Disabled
Secondary (Dual Rate Sequential Piggybacking)	Disabled	Enabled - Disabled

Configurable Settings (Continued)

Syringe Module

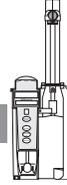

Feature	Default Setting	Options
ALL Mode	Disabled	Enabled - Disabled
Auto Pressure	Disabled	Enabled - Disabled
Back Off (after occlusion)	Enabled	Enabled - Disabled
Fast Start	Enabled	Enabled - Disabled
KVO (Keep Vein Open) <ul style="list-style-type: none"> • Rate Adjust • Volume Adjust 	Disabled 1 mL/h 5%	Enabled - Disabled 0.01 - 2.5 mL/h (0.01 - 0.09 mL/h available for 1 mL and 3 mL syringes) 0.5 - 5%
Max Rate	999 mL/h	0.1 - 99.9 mL/h in 0.1 mL/h increments; 100 - 999 mL/h in 1 mL/h increments
Near End (NEOI) <ul style="list-style-type: none"> • Alert Time 	Disabled 60	Enabled - Disabled 1 - 60 minutes or 25% of remaining infusion time, whichever comes later
Occlusion Pressure Set Point <ul style="list-style-type: none"> • With Disc • No Disc 	1000 mmHg High	25 - 1000 mmHg in 1 mmHg increments Low, Medium, High
Priming	Disabled	Enabled - Disabled

Specifications

Pump Module



Accumulated Air Window:

Single Bolus Setting (mcL)	Volume Window (mL)	% Air that Causes Alarm
50	2.8	10%
75	8.0	20%
250	8.0	30%
500*	12.0	30%

* In Anesthesia Mode only.

Bolus Volume, Maximum after Occlusion:

Pressure Limit (mmHg)	Rate (mL/h)	Bolus Volume (mL)
50	25	≤0.3
525	25	≤0.6

Critical Volume:

Maximum over-infusion that can occur in the event of a single fault condition is 0.6 mL.

Dimensions:

3.3" W x 8.9" H x 5.5" D

Environmental Conditions:

	Operating	Storage/Transport
Atmospheric Pressure	525 - 4560 mmHg (700 - 6080 hPa)	375 - 760 mmHg (500 - 1013 hPa)
Relative Humidity (Avoid prolonged exposure to relative humidity >85%)	20 - 90% Noncondensing	5 - 85% Noncondensing
Temperature Range	41 - 104°F (5 - 40°C)	-4 - 140°F (-20 - 60°C)

Equipment Orientation:

To ensure proper operation, Alaris® System must remain in an upright position.

Flow Rate Programming Increments:

Rate Range (mL/h)	Increments (mL/h)	
	User Input Rates	Device Calculated Rates
0.1 - 9.99	0.1	0.01
10 - 99.9		0.1
100 - 999	1	1

Fluid Ingress Protection:

IPX1, Drip Proof

Specifications (Continued)

Pump Module (Continued)



Infusion of Air, Means to Protect Patient from:	Ultrasonic Air-in-Line Detection Maximum single bolus size = selectable 50, 75 or 250 microliters nominal (500 microliters in Anesthesia Mode)
Infusion Pressure, Maximum:	654 mmHg (Maximum Occlusion Alarm Threshold plus tolerance)
KVO (Keep Vein Open) Rate:	Factory default setting is 1 mL/h if set rate is 1 mL/h or above; or set rate, if rate is 0.9 mL/h or below.
KVO Selection Range:	KVO rate can be set in System Configuration from 0.1 - 20 mL/h in 0.1 mL/h increments.
Occlusion Alarm Thresholds:	Pump Mode: 525 mmHg at rates ≥ 30 mL/h Varying level based on rate and patient back-pressure at rates < 30 mL/h. Selectable Mode: User selected, 50 - 525 mmHg in 25 mmHg increments.
Operating Principle:	Positive displacement
Rate Accuracy:	Rate accuracy of Alaris [®] System is $\pm 5\%$ at rates between 1 and 999 mL/h and $\pm 5.5\%$ at rates < 1 mL/h, 95% of the time with 95% confidence, under conditions listed below. Infusion Rate Range: 0.1 - 999 mL/h Ambient Temperature: $68 \pm 4^\circ\text{F}$ ($20 \pm 2^\circ\text{C}$) Source Container Height: 20 inches above top of Pump Module Test Solution: Distilled Water Distal Back pressure: 0 mmHg (0 kPa) Needle: 18 gauge Administration Set Model: 2210

WARNING

Variations of head height, back pressure or any combination of these **can affect rate accuracy**. Factors that can influence head height and back pressure are: Administration set configuration, IV solution viscosity, and IV solution temperature. Back pressure can also be affected by type of catheter. See "Trumpet and Start-Up Curves" for data on how these factors influence rate accuracy.

Shock Protection: Type CF, Defibrillator Proof

Specifications (Continued)

Pump Module (Continued)



Time to Alarm, Maximum:

Pressure Limit (mmHg)	Rate (mL/h)	Time to Alarm
50	1	≤5 minutes
50	25	≤15 seconds
525	1	≤45 minutes
525	25	≤2 minutes

**Volume to be Infused
Programming Increments:**

Range (mL)	Increments (mL)
0.1 - 9.99	0.01
10 - 999.9	0.1
1000 - 9999	1

Weight:

2.5 lbs

Syringe Module



**Bolus Volume, Maximum after
Occlusion:**

WARNING

Installing a pressure sensing disc after an infusion has started can result in a bolus to the patient.

Without Pressure Sensing Disc:

Pressure Setting	Bolus Volume (mL)
Low	0.512
Medium	0.776
High	1.103

With Pressure Sensing Disc:

Pressure Setting	Bolus Volume (mL)	
	Back Off Disabled	Back Off Enabled
300 mmHg	0.462	0.126
500 mmHg	0.575	0.331
1000 mmHg	0.839	0.323

Alaris® System has a back-off safety feature which, when enabled and a pressure sensing disc is in use, is designed to reduce bolus volume on occlusion release.

Specifications (Continued)



Syringe Module (Continued)

Bolus Volume, Maximum after Occlusion: (Continued)

Maximum Bolus Volume specifications are based on following standard operating conditions:

- Atmospheric Pressure: 645 - 795 mmHg
- Disposable Type:
 - No Pressure Disc: #30914
 - With Pressure Disc: #30920
- Humidity: 20 - 90%
- Rate: 5 mL/h
- Syringe Type: BD 50/60 mL
- Temperature: 68 ±4°F
- Volume Collection Time: approximately 2 minutes

Critical Volume:

Maximum over-infusion which can occur in the event of a single-fault condition will not exceed 2% of nominal syringe fill volume during loading and 1% of maximum syringe travel after syringe loading.

Dimensions:

4.5" W x 15.0" H x 7.5" D

Environmental Conditions:

	Operating	Storage/Transport
Atmospheric Pressure	525 - 4560 mmHg (700 - 6080 hPa)	375 - 760 mmHg (500 - 1013 hPa)
Relative Humidity (Avoid prolonged exposure to relative humidity >85%)	20 - 90% Noncondensing	5 - 85% Noncondensing
Temperature Range	41 - 104°F (5 - 40°C)	-4 - 140°F (-20 - 60°C)

Equipment Orientation:

To ensure proper operation, Alaris® System must remain in an upright position.

Specifications (Continued)

Syringe Module (Continued)

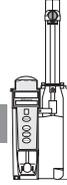

Flow Rate Programming: Flow rate range is from 0.01 to 999 mL/h and can be selected as follows:

Flow Rates (mL)	Selectable Increments (mL/h)
0.01 - 9.99	0.01
10 - 99.9	0.1
100 - 999	1

Rate Restriction by Syringe Size:

Syringe Size (mL)	Flow Rate Range (mL/h)
50/60	0.1 - 999
30	0.1 - 650
20	0.1 - 500
10	0.1 - 250
5	0.1 - 150
3	0.01 - 100
1	0.01 - 30

Fluid Ingress Protection: IPX1, Drip Proof

Infusion Pressure, Maximum: Without Pressure Sensing Disc: approximately 800 mmHg (actual occlusion pressure varies based on syringe size and manufacturer)
With Pressure Sensing Disc: 1060 mmHg

KVO (Keep Vein Open) Rate: Factory default setting is 1 mL/h if set rate is 1 mL/h or above; or set rate, if rate is 0.9 mL/h or below.

KVO Selection Range: KVO rate can be set in System Configuration, in 0.01 mL/h increments, as follows:
0.01 - 2.5 mL/h (0.01 - 0.09 mL/h available for 1 mL and 3 mL syringes)

Occlusion Alarm Thresholds: Without Pressure Sensing Disc: Three settings—Low, Medium, High
With Pressure Sensing Disc: User selected, 25 - 1000 mmHg in 1 mmHg increments.

Operating Principle: Positive displacement

Specifications (Continued)

Syringe Module (Continued)

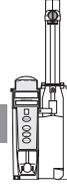

Rate Accuracy: ±2% of full scale plunger travel (not including syringe variation)

WARNING

Syringe size and running force, variations of back pressure, or any combination of these **can affect rate accuracy**. Factors that can influence back pressure are: Administration set configuration, IV solution viscosity, and IV solution temperature. Back pressure can also be affected by type of catheter. See "Trumpet and Start-Up Curves" for data on how these factors influence rate accuracy.

Shock Protection: Type CF, Defibrillator Proof

Time to Alarm, Maximum:

Rate (mL/h)	Pressure Limit	
	No Disc High Setting	With Disc Highest (1000 mmHg) Setting
1	120 minutes	105 minutes
5	30 minutes	30 minutes

Maximum Time to Alarm specifications are based on following standard operating conditions:

Atmospheric Pressure: 645 - 795 mmHg

Back Pressure: 0 mmHg before producing occlusion

Disposable Type:

No Pressure Disc: #30914

With Pressure Disc: #30920

Humidity: 20 - 90%

Syringe Type: BD 50/60 mL

Temperature: 68 ±4°F

**Volume to be Infused
Programming Increments:**

Range (mL)	Increments (mL)
0.1 - 9.99	0.01
10 - 60	0.1

Weight: 4.5 lbs

Symbols

See the PC Unit section of this DFU for system symbols.

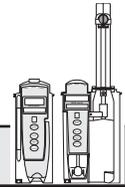

Symbol	Meaning—Pump and Syringe Modules
	Type CF defibrillation-proof equipment.
Single-Use 	Single-Use. Do not reuse.
	Product contains micron filter, where XX represents filter size.
	DEHP in fluid pathway.
	Non-DEHP plasticizer in fluid pathway.
	No DEHP in fluid pathway.
	Product is latex-free.
	Product incorporates Needle-Free Valve ports and should not be accessed by a needle.
	Approximate administration set priming volume.
	Expiration date for product is identified near hour glass symbol.
	Do not use if package is damaged.
	Manufacturer



Symbol	Meaning—Pump Module
	Drops per milliliter specification for product is identified on drop symbol.

Trumpet and Start-Up Curves

In this instrument, as with all infusion systems, the action of the pumping mechanism and variations in individual administration sets cause short-term fluctuations in rate accuracy. The following graphs show typical performance of the system, as follows:

- Accuracy during various time periods over which fluid delivery is measured (trumpet curves).
- Delay in onset of fluid flow when infusion commences (start-up curves).

Trumpet curves are named for their characteristic shape. They display discrete accuracy data averaged over particular time periods or "observation windows," not continuous data versus operating time.

Over long observation windows, short-term fluctuations have little effect on accuracy, as represented by the flat part of the curve. As the observation window is reduced, short-term fluctuations have greater effect, as represented by the "mouth" of the trumpet. Knowledge of system accuracy over various observation windows might be of interest when certain drugs are being administered.

Because the clinical impact of short-term fluctuations on rate accuracy depends on the half-life of the drug being infused and on the degree of intravascular integration, the clinical effect cannot be determined from the trumpet curves alone. Knowledge of the start-up characteristics should also be considered.

The start-up curves represent continuous flow rate versus operating time for 2 hours from the start of the infusion. They exhibit the delay in onset of delivery due to mechanical compliance and provide a visual representation of uniformity. Trumpet curves are derived from the second hour of this data.

Pump Module



Effects of Pressure Variations

Under conditions of +100 mmHg pressure, the Pump Module typically exhibits a long-term accuracy offset of approximately -0.7% from mean values.

Trumpet and Start-Up Curves (Continued)

Pump Module (Continued)



Under conditions of +300 mmHg pressure, the Pump Module typically exhibits a long-term accuracy offset of approximately -4.2% from mean values.

Under conditions of -100 mmHg pressure, the Pump Module typically exhibits a long-term accuracy offset of approximately +4.4% from mean values.

Resulting trumpet observation points typically track those of accuracy; therefore, no significant change in short-term variations result under these pressure conditions.

Effects of Negative Solution Container Heights

With a negative head height of -0.5 meters, the Pump Module typically exhibits a long-term accuracy offset of approximately -3.1% from mean values.

Resulting trumpet observation points typically track those of accuracy; therefore, no significant change in short-term variations result under negative head height conditions.

Syringe Module



Trumpet and start-up curves have been provided for 1.0 mL/h and 5.0 mL/h. Measurements for trumpet curve rates below 1.0 mL/h are not provided because of the difficulty in measuring extremely small volumes over a large duration of time. In this case, the linear relationship of the plunger position and velocity to syringe volume and rate is verified, and is a function of the accuracy of the design.

Measurements for trumpet curve rates above 5.0 mL/h are also not provided, as the syringe volume is displaced in a very short time with a rate up to 999 mL/h. Accuracy, however, is assured with the design implementation.

Under conditions of -100 mmHg, +100 mmHg, and +300 mmHg pressures, the Syringe Module typically exhibits a long-term accuracy offset of approximately 0.2% or less from the mean value.

Trumpet and Start-Up Curves (Continued)

Graphs

Pump Module

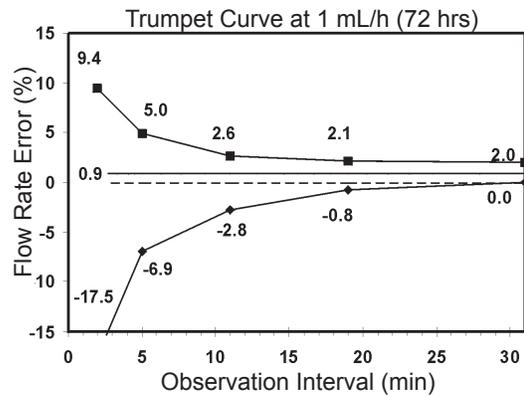
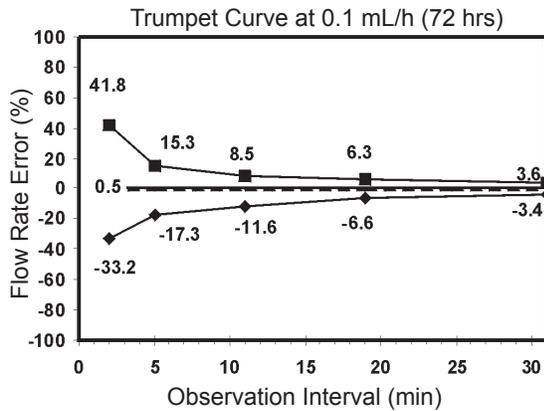
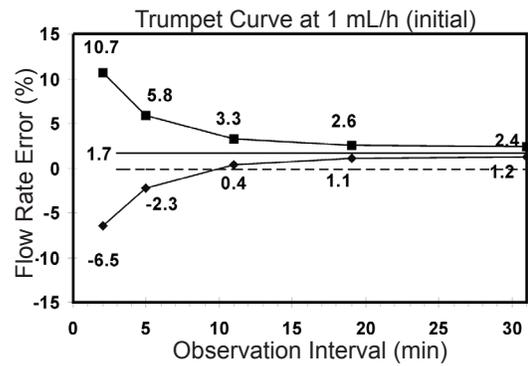
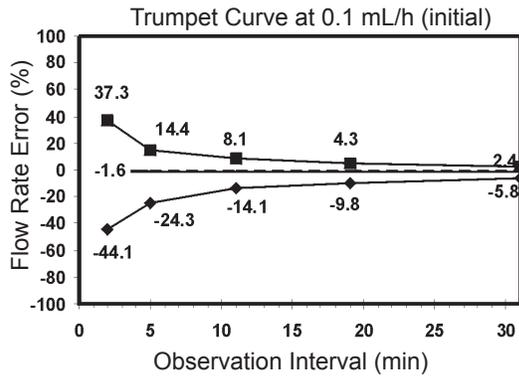
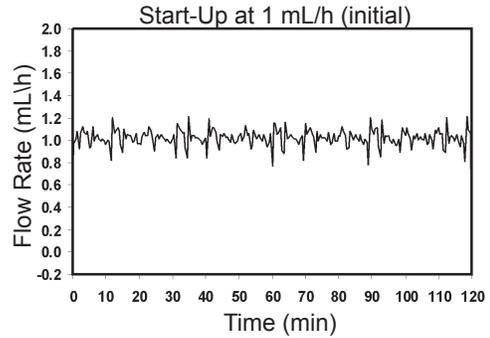
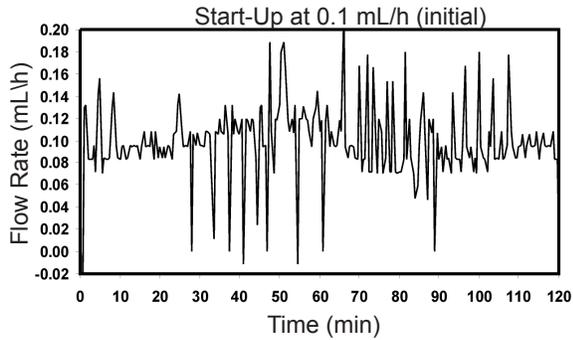

NOTE: The plot range has been increased to $\pm 100\%$ to allow visualization of the graph.

Legend:

- Maximum rate error
- Overall rate error
- ◆ Minimum rate error

Trumpet and Start-Up Curves (Continued)

Graphs (Continued)

Pump Module (Continued)

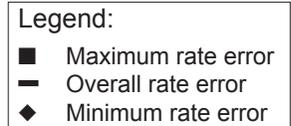
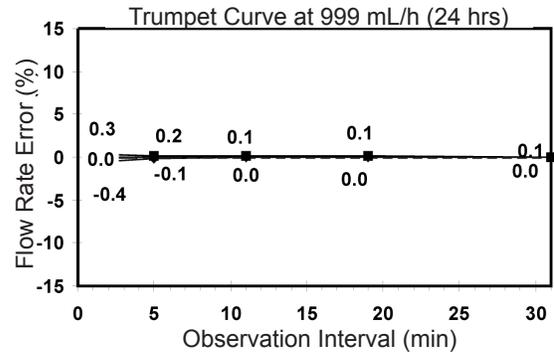
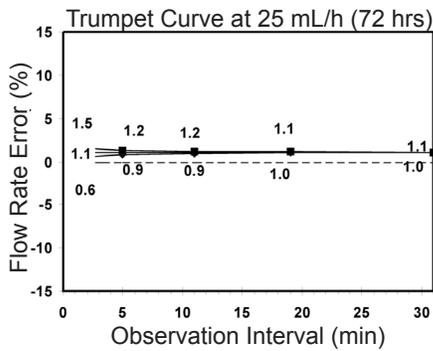
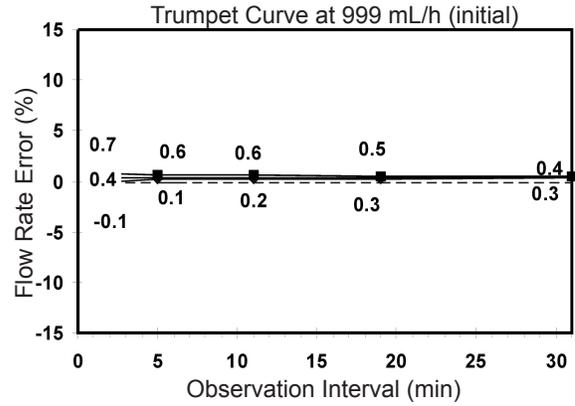
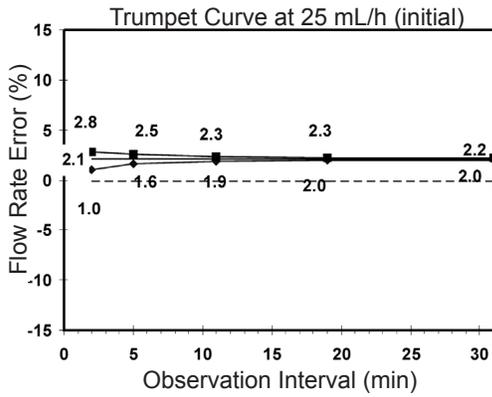
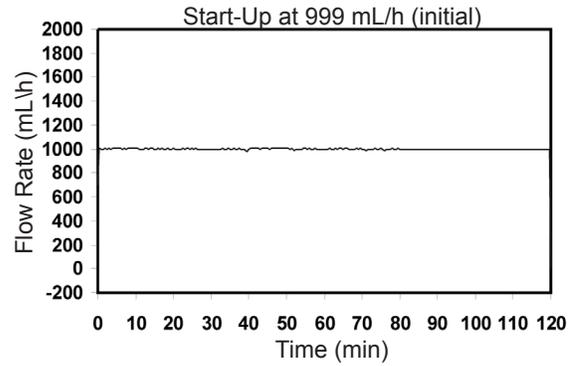
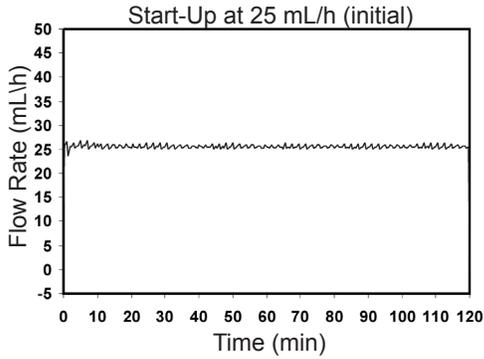

Trumpet and Start-Up Curves (Continued)

Graphs (Continued)

Syringe Module

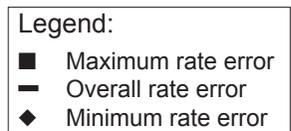
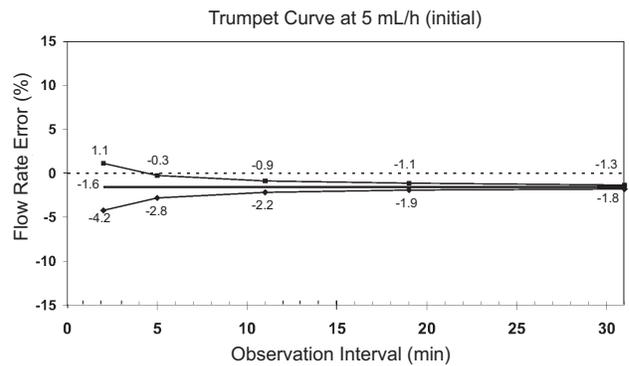
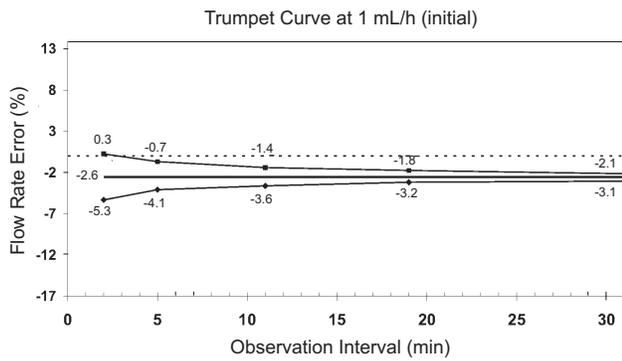
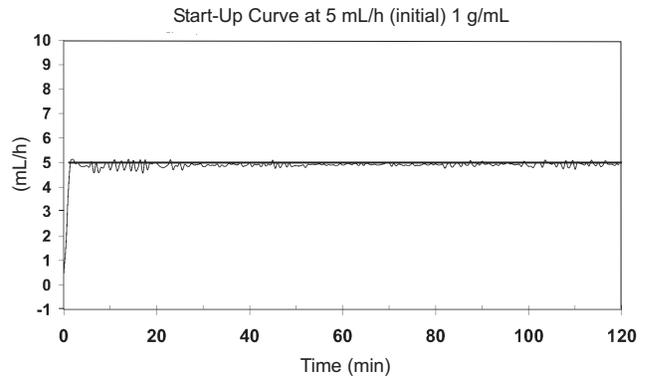
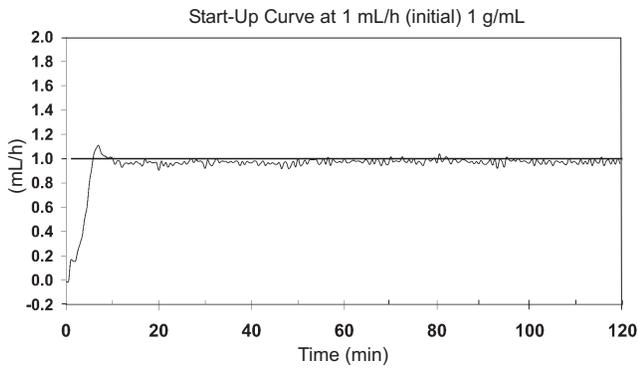

THIS PAGE
INTENTIONALLY
LEFT BLANK

Troubleshooting and Maintenance

General

Troubleshooting and maintenance are intended to be performed only by qualified personnel, using the Pump Module and Syringe Module Technical Service Manuals, and the System Maintenance software. The Service Manuals and System Maintenance software are available from CareFusion. The Service Manuals include routine service schedules, interconnect diagrams, component parts lists and descriptions, test procedures, and other technical information to assist qualified service personnel in repair and maintenance of the instrument's repairable components. The System Maintenance software is used to perform a new instrument check-in, preventive maintenance tests, calibration checks, calibration, and other maintenance functions.

Artifacts: It is normal for an infusion device to produce nonhazardous currents when infusing electrolytes. These currents vary proportional to the infusion device flow rate. When an ECG monitoring system is not functioning under optimal conditions, these currents might appear as artifacts, simulating actual ECG readings. To determine if ECG abnormalities are caused by patient condition or the ECG equipment, place the infusion device on hold. If the ECG readings become normal, the ECG equipment requires attention. Proper setup of the ECG equipment should eliminate these artifacts. Refer to the appropriate ECG monitoring system documentation for instructions on setup and maintenance.

Alarms, Errors, Messages

See the PC Unit section of this DFU for the following system references:

- Alarms, Errors, Messages
- Audio Characteristics
- Definitions
- Radio Frequency Note

Alarms, Errors, Messages (Continued)

Definitions

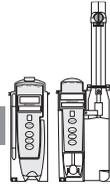

Alert

A visual message to help reduce programming errors by indicating a Limit (Soft or Hard) has been exceeded. A response is required before programming can continue.

Clinical Advisory

A visual message when a designated drug is selected to remind clinician of specific hospital/facility standards of practice when programming an IV medication. A specific Clinical Advisory and/or message can be associated with a selected drug within any of the patient care profiles. Clinical Advisories are not displayed in Anesthesia mode.

Audio Characteristics



Type	Sound	Note
Switchover	Six short beeps: secondary switching to primary. Two short beeps: bolus switching to continuous.	Variable volume; can be silenced and disabled in System Configuration.

Alarms

Pump and Syringe Modules		
Alarm	Meaning	Response
Channel Disconnected	Module disconnected while in operation or have a communication problem.	To silence alarm and clear message from screen, press CONFIRM soft key. Reattach module if desired, ensuring it is securely "clicked" into place at Module Release Latch. If alarm is still present, replace module.

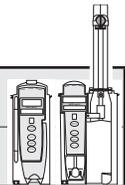

Alarms, Errors, Messages (Continued)

Alarms (Continued)

Pump Module		
Alarm	Meaning	Response
Accumulated Air-in-Line	A large number of air bubbles smaller than current air-in-line limit has recently passed detector.	Clear air from line. To continue infusion, press RESET soft key and then RESTART key.
Air-in-Line	Air has been detected in administration set during an infusion. Infusion stops on affected module.	Ensure that tubing is properly installed in Air-in-Line Detector. If air is present, clear air from administration set. Press RESTART key, or press CHANNEL SELECT key and then START soft key.
Check IV Set	Administration set is not properly installed. Infusion stops on affected module.	Close roller clamp, remove and reinstall administration set, close door, open roller clamp, and then press RESTART key.
Close Door	Door opened during an infusion. Infusion stops on affected module.	Close door. Press RESTART key, or press CHANNEL SELECT key and then START soft key.
Flo-Stop Open - Close Door (v9.0 PC Unit only)	Safety clamp device is in open position while door is open.	Close roller clamp on administration set or close door.
Occluded - Fluid Side/Empty Container	Indicates either upstream occlusion or empty container. Infusion stops on affected module.	Clear occlusion on fluid side of instrument. If necessary, refill drip chamber. Press RESTART key, or press CHANNEL SELECT key and then START soft key.
Occluded - Patient Side	Increased back pressure sensed while infusing in pump delivery mode. Infusion stops on affected module.	Clear occlusion. Press RESTART key, or press CHANNEL SELECT key and then START soft key.
Partial Occlusion - Patient Side	Partial occlusion of patient side of IV line detected by Auto-Restart feature.	Clear occlusion. Press RESTART key, or press CHANNEL SELECT key and then START soft key.



Alarms, Errors, Messages (Continued)

Alarms (Continued)

Pump Module		
Alarm	Meaning	Response
Pump Chamber Blocked	Tubing blocked inside Pump Module (in pump chamber).	<ol style="list-style-type: none"> 1. Close roller clamp and open door. 2. Remove tubing. 3. Massage tubing from top to bottom to restore flow. 4. Reload set and close door. 5. Press NEXT soft key. 6. Press CONFIRM soft key. 7. Open roller clamp and press RESTART key. 8. Verify flow in drip chamber after restarting infusion. 9. Change set if not able to establish flow.
Restart Channel	<p>Door opened and closed during an infusion. Infusion stops on affected module.</p> <p>Module paused for 2 minutes.</p>	<p>Close door. Press RESTART key, or press CHANNEL SELECT key and then START soft key.</p> <p>Press RESTART key, or press CHANNEL SELECT key and then START soft key.</p>
Safety Clamp Open - Close Door (v9.1 and later PC Unit only)	Safety clamp device is in open position while door is open.	Close roller clamp on administration set or close door



Syringe Module		
Alarm	Meaning	Response
Occlusion	Increased back pressure sensed while infusing. Infusion stops on affected module.	Clear occlusion. Press RESTART key, or press CHANNEL SELECT key and then START soft key.
Pressure Disc Installed	Pressure sensing disc installed during an infusion. Infusion stops on affected module.	Press CONFIRM soft key and RESTART key.

Alarms, Errors, Messages (Continued)

Alarms (Continued)

Syringe Module		
Alarm	Meaning	Response
Pressure Disc Removed	Pressure sensing disc removed. Infusion stops on affected module.	Reinsert pressure sensing disc and press RESTART key.
Syringe Empty	Syringe is empty. If syringe is not empty, other possibilities are: <ul style="list-style-type: none"> • Pressure sensing disc inappropriate/defective. • Syringe plunger travel impeded. • Pressure transducer defective. 	Set up new infusion or press CHANNEL OFF key. Verify that appropriate pressure sensing disc is in use and functioning properly. Verify that syringe plunger movement is unimpeded. If syringe is not empty and above actions do not correct alarm, replace module.

Syringe Adjustment Alarms



When a syringe installation problem is detected, a visual signal is displayed. Text in the display blinks to indicate the location of the problem.

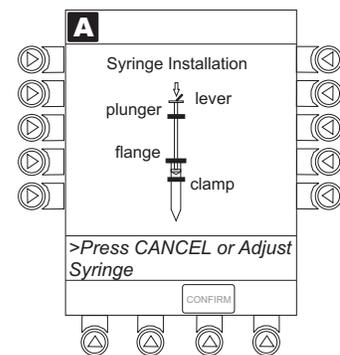

Alarms, Errors, Messages (Continued)

Alarms (Continued)

Syringe Adjustment Alarms (Continued)

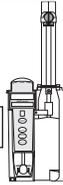

When problem is corrected, press **CONFIRM** soft key.

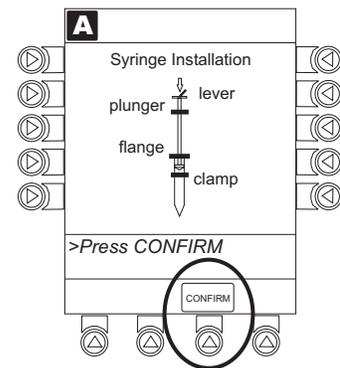

Alarm	Meaning	Response
Check Syringe	<p>Plunger grippers opened during infusion and then closed. Infusion stops on affected module.</p> <p>Syringe barrel clamp opened during infusion and then closed. Infusion stops on affected module.</p> <p>Syringe plunger not captured while in idle state. System alarms after 30 seconds to indicate potential siphoning condition.</p>	<p>Securely lock plunger grippers, press CHANNEL SELECT key, and reselect syringe.</p> <p>Securely lock syringe barrel clamp and press RESTART key.</p> <p>Check for potential siphoning. Ensure that administration set clamp (roller/slide) is in closed position. Securely lock plunger grippers over syringe plunger.</p>
Drive Not Engaged	<p>Drive system disengaged during operation.</p>	<p>Open and close plunger grippers and syringe barrel clamp. Ensure that syringe is properly installed.</p>

Alarms, Errors, Messages (Continued)

Errors

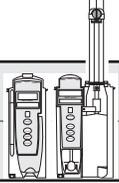
Pump and Syringe Modules 		
Error	Meaning	Response
Channel Error	Error detected. Operation stops on affected module.	To silence alarm and continue operation of unaffected module(s), press CONFIRM soft key. Replace module, as needed.

Syringe Module 		
Error	Meaning	Response
Syringe Calibration Required	Error on infusing module indicating calibration is required. Infusion stops on affected module. CALIBRATE scrolls in Message Display.	To silence alarm and continue operation of unaffected module(s), press CONFIRM soft key. Replace module, as needed.
Syringe Driver Head Error	Noninfusing module, with plunger grippers open, senses excessive pressure being applied downward on Drive Head. OCCLUSION scrolls in Message Display.	To silence alarm and continue normal operation, press CONFIRM soft key.

Messages

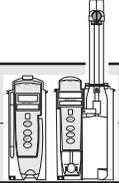
Pump and Syringe Modules 		
Message	Meaning	Response
Anesthesia Mode	Anesthesia Mode discontinued when disconnected from AC.	Press CONFIRM soft key.
Bolus Dose Complete	Module running in continuous infusion mode if programmed.	None
Delay Complete	Delay time completed.	Press RESTART key, or press CHANNEL SELECT key and then START soft key.
Infusion Complete	Current infusion completed.	Set up a new infusion or press CHANNEL OFF key.

Alarms, Errors, Messages (Continued)

Messages (Continued)

Pump and Syringe Modules		
Message	Meaning	Response
Infusion Complete - KVO	Programmed volume-to-be-infused delivered; module running at KVO rate.	Set up a new infusion or press CHANNEL OFF key.
Panel Locked	Tamper Resist feature is active and a key was pressed.	If appropriate, deactivate Tamper Resist feature using Tamper Resist Control on back of PC Unit.
Panel Unlocked	Tamper Resist feature deactivated.	None.
Pause	Pause control pressed; infusion stopped.	To resume infusion, press RESTART key, or press CHANNEL SELECT key and then START soft key.
Start time for next dose has passed.	Start of next dose passed.	Press CONFIRM soft key.

Pump Module		
Message	Meaning	Response
Checking Line	Patient-side occlusion occurred; Auto-Restart feature monitoring downstream pressure to determine if infusion can continue.	None
Secondary	Secondary infusion in progress on indicated module.	None. When secondary VTBI="0", infusion reverts to programmed primary parameters.

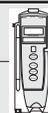

Alarms, Errors, Messages (Continued)

Messages (Continued)

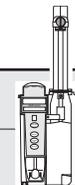

Syringe Module		
Message	Meaning	Response
After Call Back	Infusion completed.	Press CONFIRM soft key.
NEOI (Near End of Infusion)	Syringe almost empty.	None. This is a timed event that can be set. To set or change this option, see "General Information", "Configurable Settings."
Syringe Not Recognized	Installed syringe of unknown type and size.	Select and confirm correct syringe type and size, and then press CONFIRM ; or use a syringe type and size that system can automatically and correctly identify.



Possible End of Infusion Messages and Alerts (Syringe Module)

KVO	VTBI	Delayed	PC Unit Display	Module Display	Audio/Visual Alert
NA	All	Yes	Syringe Empty	Syringe Empty	Yes/Yes
On	All	No	Syringe Empty	Syringe Empty	Yes/Yes
Off	All	No	Syringe Empty	Syringe Empty	Yes/Yes
NA	Numeric	Yes	Complete	Infusion complete	Yes/Yes (If an After callback is scheduled)
NA	Numeric	Yes	Syringe Empty	Syringe Empty	Yes/Yes
Off	Numeric	No	Complete	Infusion complete	Yes/Yes
Off	Numeric	No	Syringe Empty	Syringe Empty	Yes/Yes
On	Numeric	No	Syringe Empty	Syringe Empty	Yes/Yes

Inspection Requirements

To ensure that the Alaris® System remains in good operating condition, both regular and preventive maintenance inspections are required. Refer to the System Maintenance software for detailed instructions.

REGULAR INSPECTIONS

PROCEDURE	FREQUENCY
INSPECT FOR DAMAGE: <ul style="list-style-type: none">• Exterior Surfaces• IUI Connector• Keypad• Mechanical Parts• Membrane Frame Assembly (Pump Module)	<ul style="list-style-type: none">• Each usage• Each usage• Each usage• Each usage• Each usage
CLEANING	As required
START-UP	Each usage

WARNING

Failure to perform these inspections can result in improper instrument operation.

CAUTION

Preventive maintenance inspections should only be performed by qualified service personnel.

Alaris® PCA Module Model 8120

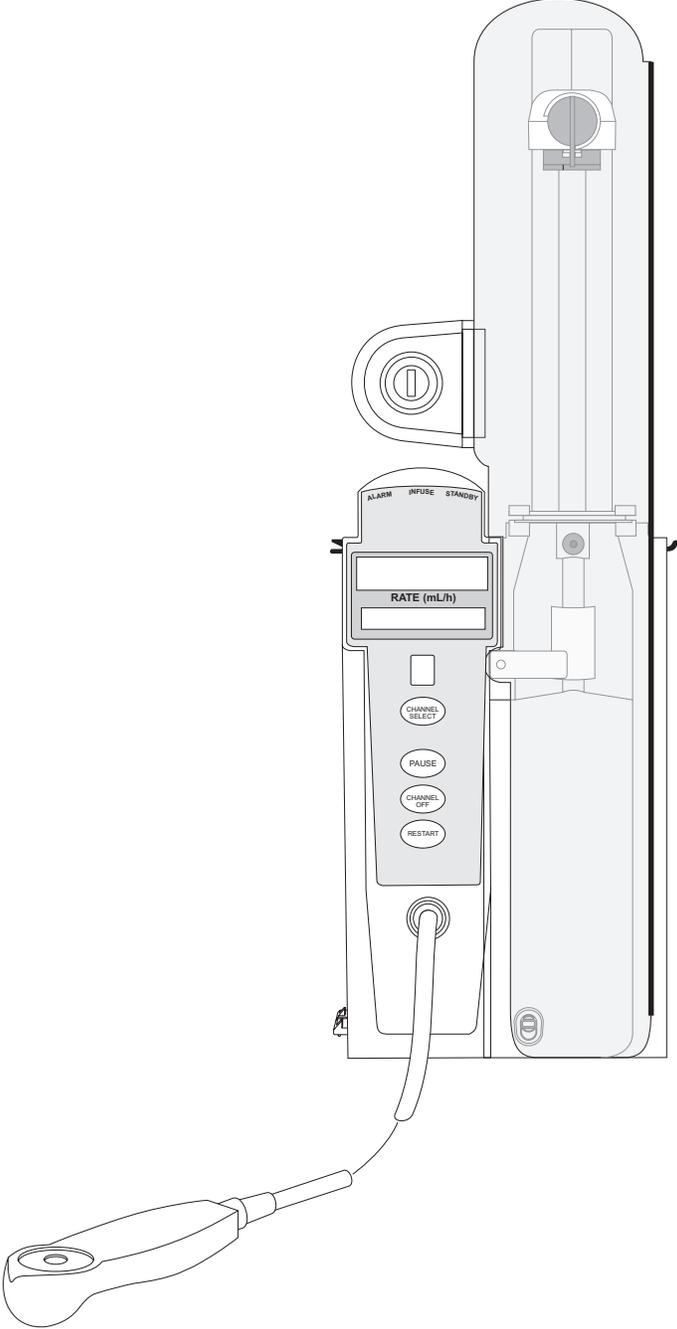

Getting Started

Introduction	3-1
Attach and Detach Dose Request Cord	3-2
Prepare and Load Syringe and Administration Set	3-3
Prepare Syringe and Administration Set.....	3-3
Load Syringe and Administration Set	3-3
Security Lock Key Positions	3-6

Programming

Prepare Infusion	3-7
Select Syringe Type and Size.....	3-7
Prime.....	3-8
Program an Infusion	3-10
Infusion Modes	3-12
Programming Parameters.....	3-12
Set Up PCA Dose Only.....	3-13
Set Up Continuous Infusion Only.....	3-15
Set Up PCA Dose + Continuous Infusion	3-17
Set Loading Dose Only	3-20
Set Bolus Dose	3-21
Stop a Loading, PCA or Bolus Dose.....	3-23
Change Programming Parameters During an Infusion.....	3-24
View Patient History.....	3-25
Clear Patient History.....	3-26
View Drug Event History.....	3-27
Configure Dose Request Cord	3-27
Security Access Levels.....	3-29
Disable Security Access Code	3-29
Pause Infusion	3-30
Change Syringe and Restore Infusion	3-31
Stop Infusion	3-32
Select Pressure Limit.....	3-33
View and Clear Volume Infused.....	3-33
PCA Pause Protocol Feature.....	3-34
Program an Infusion	3-34
Review or Change PCA Pause Alarm Limits.....	3-36
Disable PCA Pause Alarm.....	3-37

General Setup and Operation

Secure to Pole Using Optional Locking Pole Clamp	3-39
System Start-Up/Setup.....	3-39

General Information

Warnings and Cautions	3-41
General	3-41
Administration Sets.....	3-41
Epidural Administration.....	3-43
Dose Request Cord	3-43
Guardrails® Suite MX.....	3-44

General Information (Continued)

Administration Set Information	3-44
Compatible Syringes	3-45
Features and Displays	3-45
Features and Definitions	3-45
Operating Features, Controls, Indicators	3-50
Displays	3-51
Configurable Settings	3-51
Specifications and Symbols	3-53
Specifications	3-53
Symbols	3-55
Trumpet and Start-Up Curves	3-56

Troubleshooting and Maintenance

General	3-59
Alarms, Errors, Messages	3-59
Definitions	3-60
Alarms	3-60
Errors	3-62
Messages	3-62
Inspection Requirements	3-64

Introduction

This section of the DFU provides PCA Module (Model 8120) instructions and information. It is used in conjunction with:

- Alaris® product administration set instructions
- Drug product labeling
- PCA Module Set Compatibility Card
- PCA Module Technical Service Manual
- PC Unit section of this DFU
- System Maintenance software (and its instructions) for Alaris® System check-in, maintenance, and wireless configuration

The PCA Module is intended for facilities that utilize syringe pumps for the delivery of medications or fluids. The PCA Module is indicated for use on adults, pediatrics and neonates for continuous or intermittent delivery through clinically acceptable routes of administration; such as, intravenous (IV), subcutaneous or epidural. Only one PCA Module can be connected to the Alaris® System.

Administration Sets/Syringes: See "General Information" for specific administration set and syringe instructions.

- Administration Set Information
- Compatible Syringes

Alarms, Errors, Messages: See "Troubleshooting and Maintenance" for module-specific alarms, errors and messages.

Contraindications: None known.

Electromagnetic Environment: See "Appendix" section of this DFU ("Regulations and Standards," "Compliance").

WARNING

Read all instructions, for both the PCA Module and PC Unit, before using the Alaris® System.

CAUTION

Rx Only

Attach and Detach Dose Request Cord

The Dose Request Cord must be attached to the PCA Module when delivering a PCA dose or PCA + continuous dose infusion.

WARNING

Carefully locate the Dose Request Cord to reduce the possibility of patient entanglement or strangulation.

To attach Dose Request Cord:

Insert latching connector into Dose Request Cord attachment. Red marking on latching connector should be aligned with red marking on Dose Request Cord receptacle.

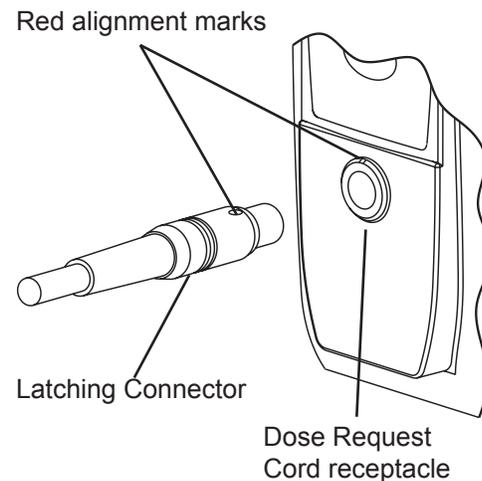

To detach Dose Request Cord:

Hold body of latching connector and pull straight out, without twisting or turning, from Dose Request Cord receptacle.

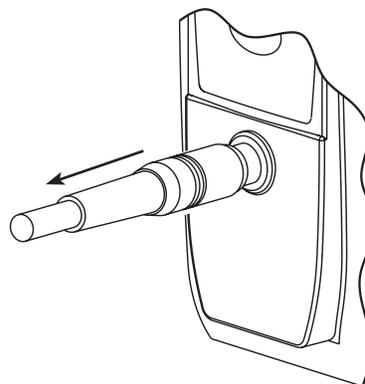

Prepare and Load Syringe and Administration Set

For instructions on how to go from checking in a PCA Module to preparing it for an infusion setup, see "General Setup and Operation."

Prepare Syringe and Administration Set

1. Prepare syringe (see "General Information," "Compatible Syringes") in accordance with manufacturer's directions for use.
2. Prepare administration set (refer to Set Compatibility Card, provided separately) in accordance with manufacturer's directions for use.
3. Attach upper fitting of administration set to syringe tip.

WARNING

Use only standard or pre-filled, single-use, disposable syringes (with luer-lock connectors) and nondedicated administration sets with integrated anti-siphon valves, designed for use on syringe-type PCA pumps. The use of any other **syringe or administration set** can cause improper instrument operation, resulting in inaccurate fluid delivery, pressure sensing, or other potential hazards. For a list of compatible syringes, see "General Information," "Compatible Syringes." For a list of compatible administration sets, refer to the Set Compatibility Card (provided separately).

Load Syringe and Administration Set

WARNING

Before loading or unloading the syringe, always turn off fluid flow to the patient, using the tubing clamp or stopcock. Uncontrolled fluid flow can occur when the administration set is not clamped or turned off, and can cause serious injury or death.

Prepare and Load Syringe and Administration Set (Continued)

Load Syringe and Administration Set (Continued)

1. Open syringe barrel clamp.
 - a. Pull syringe barrel clamp out and hold.
 - b. Rotate clamp to left (clockwise or counter clockwise) until it clears syringe chamber.
 - c. Gently release clamp.

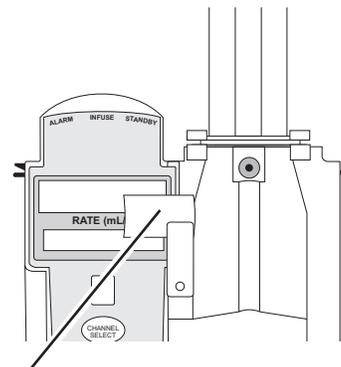

Syringe Barrel Clamp Open

2. Raise drive head to its fully extended position.
 - a. Twist gripper control clockwise and hold in position. ①
 - b. While holding gripper control in open position, raise drive head to full extension.
 - c. Gently release gripper control.

Drive Head Fully Extended

Gripper Control/Drive Head Release in Open Position

Plunger Grippers Open

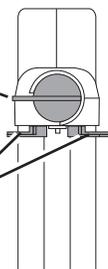

3. Insert syringe (from front of instrument) by sliding flat edge of syringe barrel flange between barrel flange grippers.

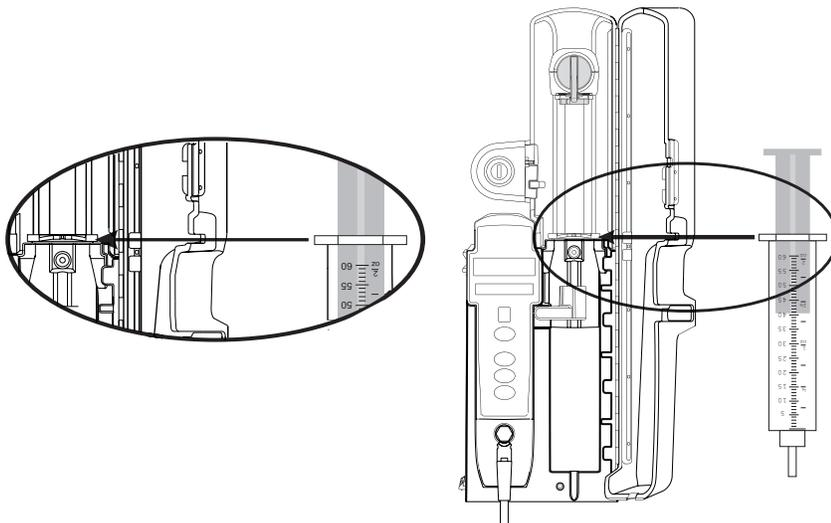

WARNING

Before loading the syringe, check it for damage or defects.

CAUTION

When initially loading the syringe, allow for the volume of fluid contained in the administration set and retained in the syringe at the end of an infusion, as this "dead space" will not be infused.

Prepare and Load Syringe and Administration Set (Continued)

Load Syringe and Administration Set (Continued)

4. Lock syringe in place.
 - a. Pull syringe barrel clamp out and hold.
 - b. Rotate clamp to right (clockwise or counter clockwise) until it lines up with syringe.
 - c. Gently release clamp against syringe.

WARNING

Ensure that syringe barrel, flange, and plunger are installed and secured correctly. Failure to **install syringe correctly** can result in uncontrolled fluid flow to the patient, and can cause serious injury or death.

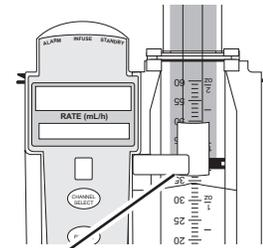

Syringe Barrel Clamp Closed

5. Lower drive head and lock plunger in place with plunger grippers.
 - a. Twist gripper control clockwise and hold in position. ①
 - b. While holding gripper control in open position, gently lower drive head until it makes contact with plunger flange.
 - c. Gently release gripper control.
 - d. Ensure that plunger grippers lock and hold plunger in place.

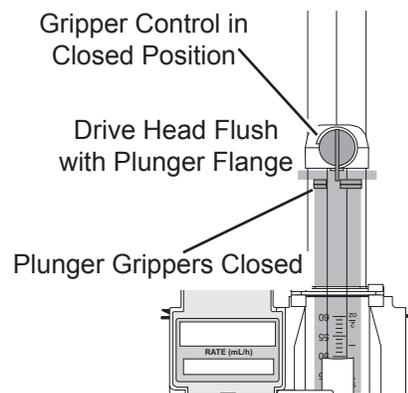

NOTE:

- ① The gripper control is spring loaded. When twisted to the open position and then released, it (and the plunger grippers) returns to the closed position.

Prepare and Load Syringe and Administration Set (Continued)

Security Lock Key Positions

There are three key positions associated with the security lock:

- UNLOCK unlocks security door. Key must be in this position when loading or changing a syringe.
- PROGRAM allows for changes in programming without unlocking security door or interrupting current infusion.
- LOCK locks security door. Key must be in this position to start an infusion.

References throughout this procedure to specific drugs and drug doses are for illustration purposes only. Refer to specific drug product labeling for information concerning appropriate administration techniques and dosages.

See "General Information," "Features and Displays" and the PC Unit section of this DFU for information about:

- Displays
- Operating Features, Controls, Indicators

Prepare Infusion

Select Syringe Type and Size

At the start of an infusion program, the system prompts the user to select and confirm the syringe type and size. The system automatically detects the syringe size, and lists syringe types and sizes that most closely match the installed syringe. If the syringe is not recognized, **Syringe not recognized** is displayed.

1. Press **CHANNEL SELECT** key. Key must be in **PROGRAM** position.

WARNING

Ensure that the displayed **syringe manufacturer and size** correctly identifies the installed syringe. Mismatches can cause an under-infusion or over-infusion to the patient that could result in serious injury and/or death. For a list of compatible syringes, see "General Information," "Compatible Syringes." If the installed syringe is displayed and selected, but is not recognized, servicing is required (see "Service Information" in "Appendix" section of this DFU).

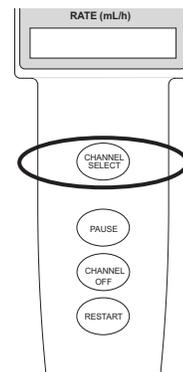

Prepare Infusion (Continued)

Select Syringe Type and Size (Continued)

2. Press soft key next to installed syringe type and size. If installed syringe is not listed, press **ALL SYRINGES** soft key and select syringe from list.
 - Selection is highlighted.
 - **CONFIRM** soft key is activated.

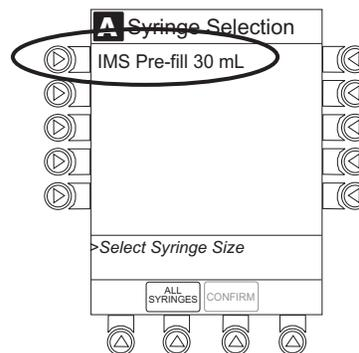

3. To accept, press **CONFIRM** soft key.
Drug Library screen is displayed.

Prime

The Priming option can be enabled at the time the Alaris® System is configured for use. The Priming selection (**PRIME** soft key) is available only after the syringe type and medication selection (prior to infusion mode selection).

WARNING

When priming:

- Ensure that patient is not connected.
- Ensure that air is expelled from line prior to beginning infusion (unexpelled air in line could have serious consequences).

Failure to prime correctly can delay infusion delivery and cause the total volume to be infused to read higher than the actual total delivered to the patient.

CAUTION

During priming, the pressure limit alarms are temporarily increased to their maximum level.

Prepare Infusion (Continued)

Prime (Continued)

1. Press **OPTIONS** key.

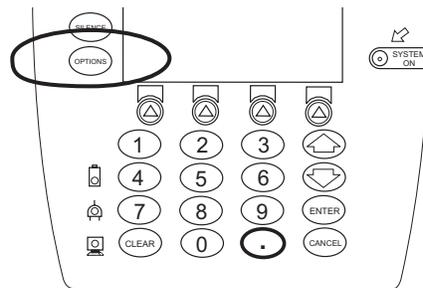

2. Press **Prime Set with Syringe** soft key.

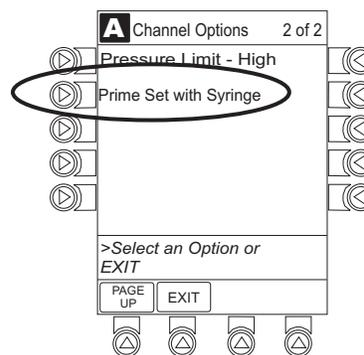

3. Press and hold **PRIME** soft key until fluid flows and priming of syringe administration set is complete.

- Volume used during priming is displayed but is not added to **VTBI**.
- Fluid is delivered during priming only while **PRIME** soft key is pressed. Each press of **PRIME** soft key delivers up to 2 mL of priming/fluid per continuous press. To deliver additional amounts, press **PRIME** soft key again.

4. When priming is complete, release **PRIME** soft key.
5. To return to main screen, press **EXIT** soft key.

Guardrails Drug Setup screen is displayed.

6. Select infusion mode.

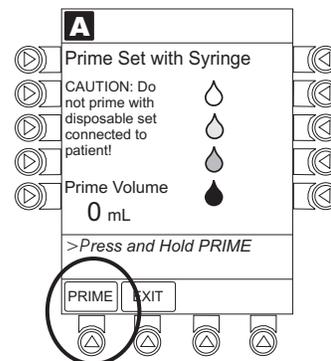

Prepare Infusion (Continued)

Program an Infusion

1. Perform steps in "Getting Started," "Prepare Syringe and Administration Set."
2. Perform following steps (see PC Unit section of this DFU, "General Setup and Operation," "Startup"):
 - a. Power on system.
 - b. Choose **Yes** or **No** to **New Patient?**
 - c. Select profile, if required.
 - d. Enter patient identifier, if required.
3. Press **CHANNEL SELECT** key.
4. Unlock security door or set key to **PROGRAM** position.
5. Confirm time of day or change time if necessary.

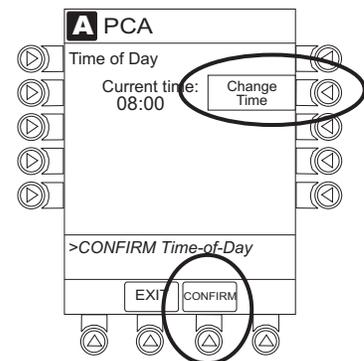

6. Perform following steps:
 - a. Load syringe and administration set (see "Getting Started," "Load Syringe and Administration Set").
 - b. Select and confirm syringe type and size (see "Select Syringe Type and Size").
7. Press soft key next to desired drug.
Drug/Concentration screen appears.

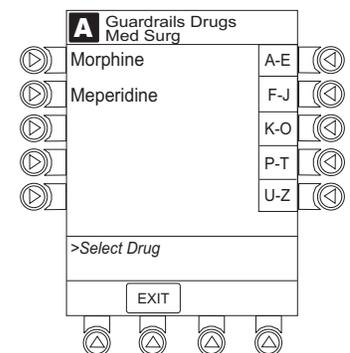

Prepare Infusion (Continued)

Program an Infusion (Continued)

8. Press soft key next to desired concentration.
 - Drug/Concentration confirmation screen appears.
 - To view additional drugs/concentrations, press **PAGE UP** and **PAGE DOWN** soft keys.
 - Facility can choose to prepopulate standard drug concentrations, or leave an open entry (__ / __ mL) and allow clinician to enter drug amount and diluent volume.
9. Confirm drug and concentration selection and press **Yes** soft key. To change selection, press **No** soft key.
 - If **Yes** was selected and facility has defined a Clinical Advisory for that drug, a message appears. To continue programming, press **CONFIRM** soft key.
 - If programmed " __ / __ mL" concentration is outside Soft Limit, an audio alert sounds and a visual prompt appears before programming can continue. If **Yes** soft key is pressed, programming continues; if **No** soft key is pressed, infusion must be reprogrammed.
 - If programmed " __ / __ mL" concentration is outside Hard Limit for that care area, an audio alert sounds and a visual prompt appears before programming can continue. Drug amount and diluent volume must be reprogrammed.
 - If there is a potential for a programmed " __ / __ mL" parameter to result in an excessive volume or dose being delivered, following prompt appears:

"Cannot proceed due to incorrect concentration or dosing parameters. Remove syringe, verify concentration, and reprogram."

The prompt can be (a) the result of an incorrect drug amount and/or diluent volume entry, or (b) can occur if hospital-established Guardrails® limits are very wide. Be sure to enter either a drug amount per 1 mL or total drug amount per total volume—for example, a 30 mL syringe with a concentration of 1 mg/1 mL can be entered in one of two ways:

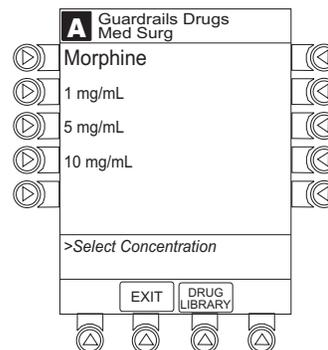

Prepare Infusion (Continued)

Program an Infusion (Continued)

Drug Amount 1 mg
Diluent Volume 1 mL

OR

Drug Amount 30 mg
Diluent Volume 30 mL

- If a Soft Limit is overridden, **G** icon is displayed. When **G** soft key is pressed, all applicable out-of-range limits are listed.
10. Verify correct parameters and press **NEXT** soft key to confirm.
 11. Prime syringe using Prime feature, if desired.

Infusion Modes

Programming Parameters

The PCA Module uses the following programming parameters, depending on infusion mode selected. See "General Information," "Features and Definitions" for infusion mode definitions and features.

- **PCA Dose:** patient self-administered dose.
- **Lockout Interval:** programmed time elapse between availability of PCA doses.
- **Continuous Dose:** basal rate dose.
- **Max Limit:** (optional) total amount of drug which can be infused over a specified time period.
- **Loading Dose:** (optional) bolus dose infused prior to initiation of PCA infusion.
- **Bolus Dose:** (optional) additional dose programmed after initiation of PCA infusion.

When the PC Unit is in the Infusion Mode Selection, Infusion Setup or Bolus Setup screens, a patient dose request from the Dose Request Cord is handled as an unmet demand.

Infusion Modes (Continued)

Set Up PCA Dose Only

1. Perform steps in "Prepare Infusion."
2. Press **PCA Dose Only** soft key from Infusion Mode screen.

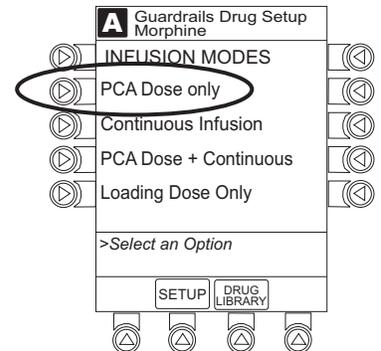

3. To enter PCA dose, use numeric data entry keys.

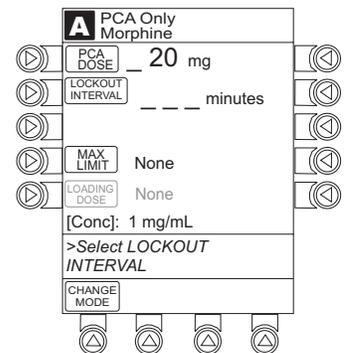

4. To enter lockout interval, press **LOCKOUT INTERVAL** soft key and use numeric data entry keys.
5. To enter maximum limit, press **MAX LIMIT** soft key and then **Yes** soft key.

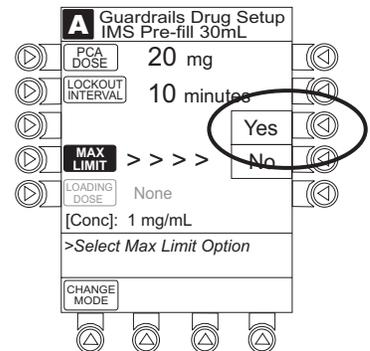

6. Enter maximum limit using numeric data entry keys.
Time (in hours) associated with **Max Limit** is automatically entered based on setup in system configuration.

Infusion Modes (Continued)

Set Up PCA Dose Only (Continued)

- To enter loading dose, press **LOAD DOSE** soft key, press **Yes** soft key and use numeric data entry keys.

Loading dose is included in volume infused but is not included in **Max Limit**.

- Verify correct parameters and press **CONFIRM** soft key.
 - If programmed parameters are outside Soft Limit, an audio alert sounds and a visual prompt appears before programming can continue. If **Yes** soft key is pressed, programming continues; if **No** soft key is pressed, infusion must be reprogrammed.
 - If programmed parameters are outside Hard Limit for that care area, an audio alert sounds and a visual prompt appears before programming can continue. Infusion must be reprogrammed.
 - If there is a potential for a programmed "___ / ___ mL" parameter to result in an excessive volume or dose being delivered, following prompt appears:

"Cannot proceed due to incorrect concentration or dosing parameters. Remove syringe, verify concentration, and reprogram."

The prompt can be (a) the result of an incorrect drug amount and/or diluent volume entry, or (b) can occur if hospital-established Guardrails® limits are very wide. Be sure to enter either a drug amount per 1 mL or total drug amount per total volume—for example, a 30 mL syringe with a concentration of 1 mg/1 mL can be entered in one of two ways:

Drug Amount 1 mg
Diluent Volume 1 mL

OR

Drug Amount 30 mg
Diluent Volume 30 mL

- If a Soft Limit is overridden, **G** icon is displayed. When **G** soft key is pressed, all applicable out-of-range limits are listed.

- Close and lock security door.

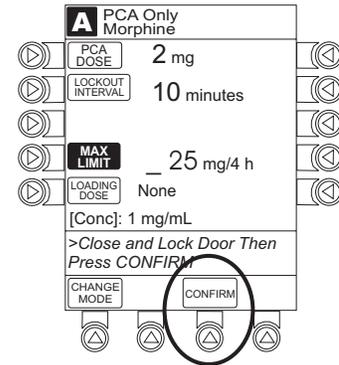

Infusion Modes (Continued)

Set Up PCA Dose Only (Continued)

10. Verify correct parameters on second nurse summary screen and press **START** soft key.
 - Infusion mode and PCA drug name scroll in Channel Message Display. If a loading dose has been entered, scrolls **DELIVERING LOAD**.
 - Main Display alternates between volume remaining and PCA drug name with infusion mode.
 - When PCA dose is delivered:
 - Green Infusing Status Indicator illuminates.
 - Rate display flashes " _ _ _ _ _".
 - **DELIVERING PCA** scrolls in channel message display.
 - When PCA dose is complete, **PCA COMPLETE** scrolls in Channel Message Display.

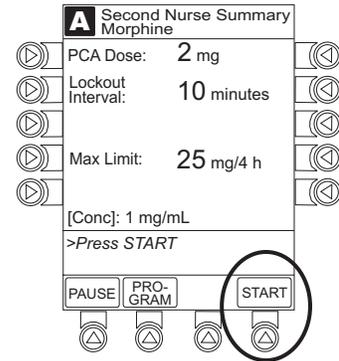

Set Up Continuous Infusion Only

1. Perform steps in "Prepare Infusion."
2. Press **CONTINUOUS INFUSION** soft key from Infusion Mode screen.
3. To enter continuous infusion dose, press **CONT DOSE** soft key and use numeric data entry keys.

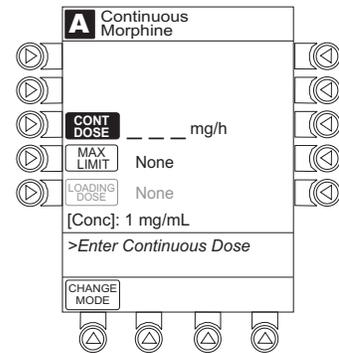
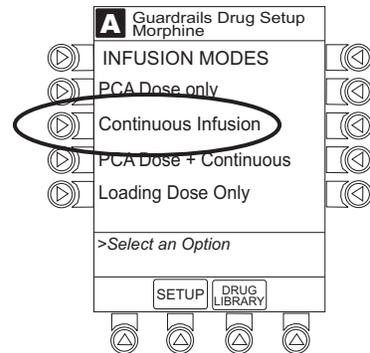

Infusion Modes (Continued)

Set Up Continuous Infusion Only (Continued)

4. To enter maximum limit, press **MAX LIMIT** soft key, press **Yes** soft key and use numeric data entry keys.

Time (in hours) associated with **Max Limit** is automatically entered based on setup in system configuration.

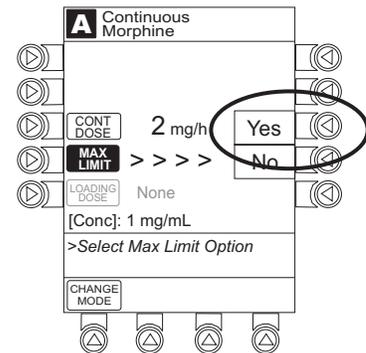

5. To enter loading dose, press **LOAD DOSE** soft key, press **Yes** soft key and use numeric data entry keys.

Loading dose is included in volume infused but is not included in **Max Limit**.

6. Verify correct parameters and press **CONFIRM** soft key.

- If programmed parameters are outside Soft Limit for that care area, an audio alert sounds and a visual prompt appears before programming can continue. If **Yes** soft key is pressed, programming continues; if **No** soft key is pressed, infusion needs to be reprogrammed.
- If programmed parameters are outside Hard Limit for that care area, an audio alert sounds and a visual prompt appears before programming can continue. Infusion needs to be reprogrammed.
- If there is a potential for a programmed " __ / __ mL" parameter to result in an excessive volume or dose being delivered, following prompt appears:

"Cannot proceed due to incorrect concentration or dosing parameters. Remove syringe, verify concentration, and reprogram."

The prompt can be (a) the result of an incorrect drug amount and/or diluent volume entry, or (b) can occur if hospital-established Guardrails® limits are very wide. Be sure to enter either a drug amount per 1 mL or total drug amount per total volume—for example, a 30 mL syringe with a concentration of 1 mg/1 mL can be entered in one of two ways:

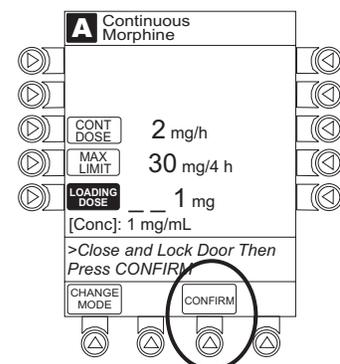

Infusion Modes (Continued)

Set Up Continuous Infusion Only (Continued)

Drug Amount 1 mg
Diluent Volume 1 mL

OR

Drug Amount 30 mg
Diluent Volume 30 mL

- If a Soft Limit is overridden, **G** icon is displayed. When **G** soft key is pressed, all applicable out-of-range limits are listed.
7. Close and lock security door.
 8. Verify correct programming parameters and press **START** soft key.
 - Green Infusing Status Indicator illuminates.
 - Infusion mode and drug name scroll in Channel Message Display. If a loading dose has been entered, **DELIVERING LOAD** scrolls.
 - Volume infused in mL/h in Rate Display.
 - Main Display alternates between volume remaining and infusion mode with drug name.

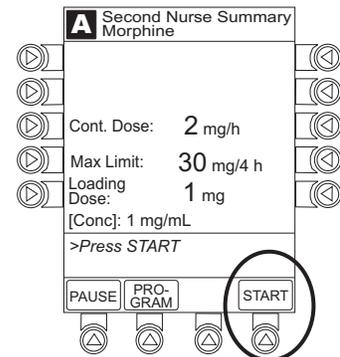

Set Up PCA Dose + Continuous Infusion

1. Perform steps in "Prepare Infusion."
2. Press **PCA DOSE + CONTINUOUS** soft key from Infusion Mode screen.

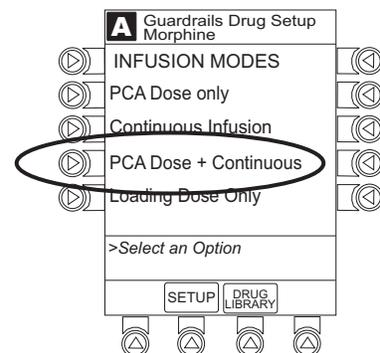

Infusion Modes (Continued)

Set Up PCA Dose + Continuous Infusion (Continued)

- To enter PCA dose, press **PCA DOSE** soft key and use numeric data entry keys.

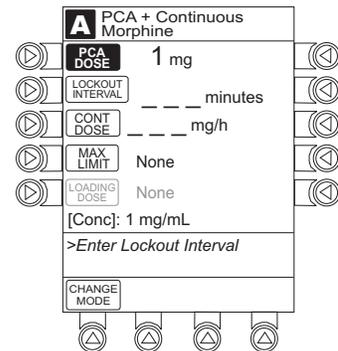

- To enter lockout interval, press **LOCKOUT INTERVAL** soft key and use numeric data entry keys.
- To enter continuous dose, press **CONT DOSE** soft key, and use numeric data entry keys.
- To enter maximum limit, press **MAX LIMIT** soft key, press **Yes** soft key and use numeric data entry keys.

Time (in hours) associated with **Max Limit** is automatically entered based on setup in system configuration.

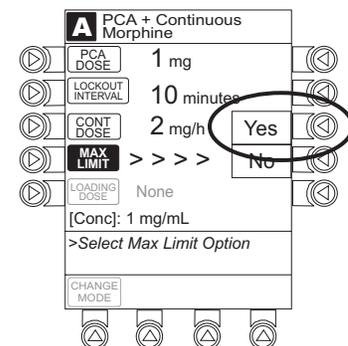

- To enter loading dose, press **LOAD DOSE** soft key, press **Yes** soft key and use numeric data entry keys.

Loading dose is included in VTBI but is not included in **Max Limit**.

- Verify correct parameters and press **CONFIRM** soft key.
 - If programmed parameters are outside Soft Limit for that care area, an audio alert sounds and a visual prompt appears before programming can continue. If **Yes** soft key is pressed, programming continues; if **No** soft key is pressed, infusion needs to be reprogrammed.
 - If programmed parameters are outside Hard Limit for that care area, an audio alert sounds and a visual prompt appears before programming can continue. Infusion needs to be reprogrammed.

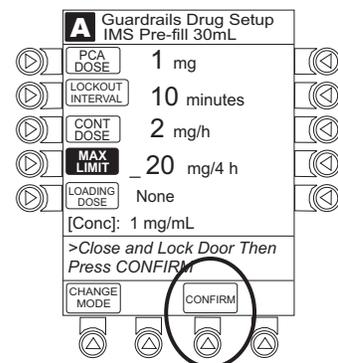

Infusion Modes (Continued)

Set Up PCA Dose + Continuous Infusion (Continued)

- If there is a potential for a programmed "__ / __ mL" parameter to result in an excessive volume or dose being delivered, following prompt appears:

"Cannot proceed due to incorrect concentration or dosing parameters. Remove syringe, verify concentration, and reprogram."

The prompt can be (a) the result of an incorrect drug amount and/or diluent volume entry, or (b) can occur if hospital-established Guardrails® limits are very wide. Be sure to enter either a drug amount per 1 mL or total drug amount per total volume—for example, a 30 mL syringe with a concentration of 1 mg/1 mL can be entered in one of two ways:

Drug Amount 1 mg
Diluent Volume 1 mL

OR

Drug Amount 30 mg
Diluent Volume 30 mL

- If a Soft Limit is overridden, **G** icon is displayed. When **G** soft key is pressed, all applicable out-of-range limits are listed.
- Close and lock security door.
 - Verify correct parameters on second nurse summary screen and press **START** soft key.

During PCA dose + continuous infusion:

- Green Infusing Status Indicator illuminates.
- DELIVERING PCA** scrolls in Channel Message Display when initiated. Continuous and PCA drug name scrolls in Channel Message Display between PCA doses.
- Volume infused for continuous dose is displayed in mL/h in Rate Display.
- Main Display alternates between volume remaining and infusion mode with PCA drug name.
- When PCA dose is complete, **PCA COMPLETE** scrolls in Channel Message Display and resumes continuous dose.

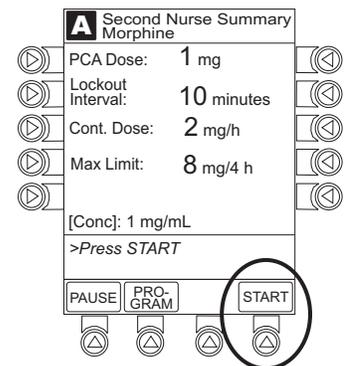

Infusion Modes (Continued)

Set Loading Dose Only

The following procedures should be used when setting a **LOADING DOSE ONLY** using the Drug Library.

1. Perform steps in "Prepare Infusion."
2. Press **LOADING DOSE ONLY** soft key from Infusion Mode screen.
3. To enter dose value, use numeric data entry keys.
4. Verify correct dose value and then press **CONFIRM** soft key.
 - Loading dose is included in VTBI but is not included in **Max Limit**.
 - If programmed loading dose is outside Soft Limit for that care area, an audio alert sounds and a visual prompt appears before programming can continue. If **Yes** soft key is pressed, programming continues; if **No** soft key is pressed, infusion needs to be reprogrammed.
 - If programmed loading dose is outside Hard Limit for that care area, an audio alert sounds and a visual prompt appears before programming can continue. Infusion must be reprogrammed.
 - If there is a potential for a programmed " __ / __ mL" parameter to result in an excessive volume or dose being delivered, following prompt appears:

"Cannot proceed due to incorrect concentration or dosing parameters. Remove syringe, verify concentration, and reprogram."

The prompt can be (a) the result of an incorrect drug amount and/or diluent volume entry, or (b) can occur if hospital-established Guardrails® limits are very wide. Be sure to enter either a drug amount per 1 mL or total drug amount per total volume—for example, a 30 mL syringe with a concentration of 1 mg/1 mL can be entered in one of two ways:

Drug Amount	1 mg
Diluent Volume	1 mL

OR

Drug Amount	30 mg
Diluent Volume	30 mL

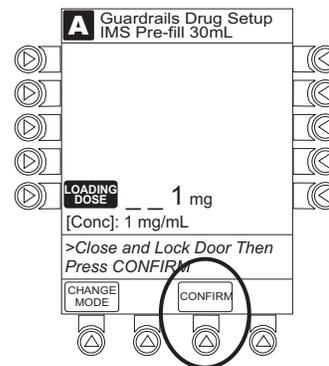

Infusion Modes (Continued)

Set Loading Dose Only (Continued)

- If a Soft Limit is overridden, **G** icon is displayed. When **G** soft key is pressed, all applicable out-of-range limits are listed.
5. Close and lock security door.
 6. Verify correct parameters on summary screen and press **START** soft key.
 - **DELIVERING LOAD** scrolls in Channel Message Display.
 - Infusion mode and drug name alternate with VTBI in Main Display.
 - When loading dose is complete, **The Loading Dose has Completed** appears on Main Display.
 7. Press **CONFIRM** soft key.

When **CHANNEL SELECT** key is pressed, Infusion Mode screen becomes available for selection of infusion mode.

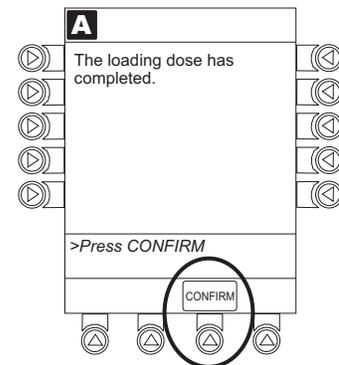
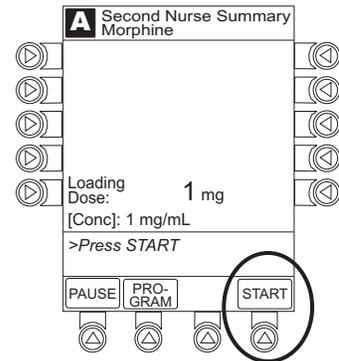

Set Bolus Dose

The following procedure should be used only when setting a **BOLUS DOSE** using the Drug Library. The **BOLUS DOSE** soft key is only available once an infusion has begun in PCA dose only, continuous infusion, or PCA + continuous infusion modes.

1. Press **CHANNEL SELECT**.

Infusion Modes (Continued)

Set Bolus Dose (Continued)

2. Press **BOLUS DOSE** soft key.

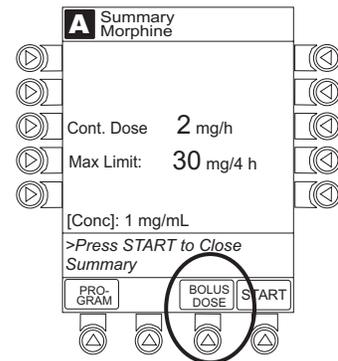

3. Set key to **PROGRAM** position or enter 4-digit authorization code and press **CONFIRM** soft key.

4. To enter dose value, use numeric data entry keys.

5. Press **CONFIRM** soft key.

- If programmed bolus dose is outside Soft Limit for that care area, an audio alert sounds and a visual prompt appears before programming can continue. If **Yes** soft key is pressed, programming continues; if **No** soft key is pressed, infusion needs to be reprogrammed.
- If programmed bolus dose is outside Hard Limit for that care area, an audio alert sounds and a visual prompt appears before programming can continue. Infusion needs to be reprogrammed.
- If there is a potential for a programmed "___ / ___ mL" parameter to result in an excessive volume or dose being delivered, following prompt appears:

"Cannot proceed due to incorrect concentration or dosing parameters. Remove syringe, verify concentration, and reprogram."

The prompt can be (a) the result of an incorrect drug amount and/or diluent volume entry, or (b) can occur if hospital-established Guardrails® limits are very wide. Be sure to enter either a drug amount per 1 mL or total drug amount per total volume—for example, a 30 mL syringe with a concentration of 1 mg/1 mL can be entered in one of two ways:

Infusion Modes (Continued)

Set Bolus Dose (Continued)

Drug Amount 1 mg
 Diluent Volume 1 mL

OR

Drug Amount 30 mg
 Diluent Volume 30 mL

- If a Soft Limit is overridden, **G** icon is displayed. When **G** soft key is pressed, all applicable out-of-range limits are listed.
6. If Authorization Code is disabled, door must be locked prior to starting bolus dose.
 7. Verify correct dose value and then press **START** soft key:
 - **Delivering Bolus** scrolls in Channel Message Display
 - Bolus and drug name alternate with VTBI in Main Display
 - When bolus dose is complete, **BOLUS COMPLETE** scrolls in Channel Message Display.
 - Programmed infusion resumes.

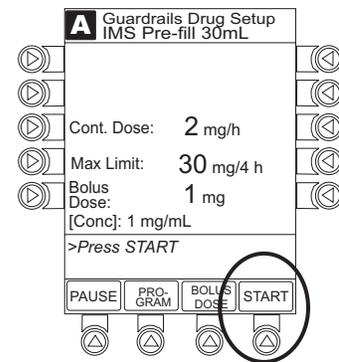

Stop a Loading, PCA or Bolus Dose

1. Press **CHANNEL SELECT** key.
2. Press **STOP LOAD**, **STOP PCA** or **STOP BOLUS** soft key as applicable.

Available soft key and stop confirmation screen are dependent on type of dose currently infusing and current infusion mode.

3. To stop dose and resume current program, press **Yes** soft key.

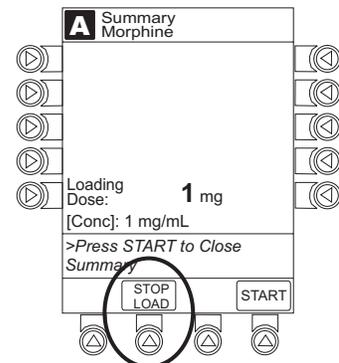

Infusion Modes (Continued)

Change Programming Parameters During an Infusion

1. Press **CHANNEL SELECT** key.
2. Press **PROGRAM** soft key.
3. Set key to program position or if Authorization Code is enabled, enter 4-digit code.
4. Press **CHANGE MODE** soft key.

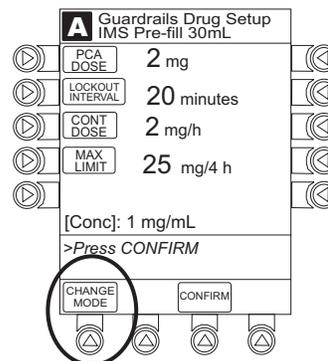

5. Select desired infusion mode.
6. Continue programming. See applicable procedure: ①
Set Up PCA Dose Only
Set Up Continuous Infusion Only
Set Up PCA + Continuous Infusion
7. Verify or change program settings and press **CONFIRM** soft key.
8. Close and lock door.
9. Verify correct programming parameters on summary screen and press **START** soft key.

NOTE:

- ① Previously programmed values are carried over to new program.

Infusion Modes (Continued)

View Patient History

1. Press **CHANNEL SELECT** key.
2. From Main Display, press **OPTIONS** key.
3. Press **Patient History** soft key.

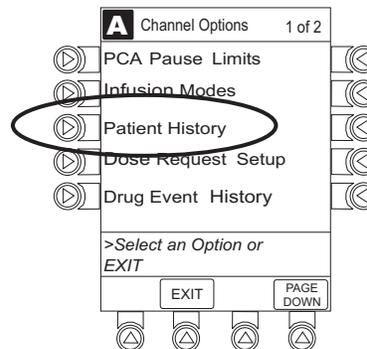

4. To select desired time period, press **ZOOM** soft key. ^①

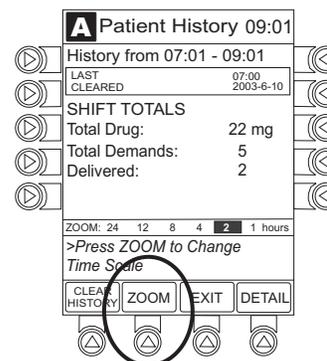

5. To view detailed patient history, press **DETAIL** soft key. ^②
6. To return to main patient history, press **MAIN HISTORY** soft key.
7. To return to Main Display, press **EXIT** soft key.

NOTES:

- ① Total drug delivered includes applicable loading dose, PCA dose, continuous dose, and bolus dose. Total drug delivered does not include priming volume.
- ② **Patient History** stores a rolling 24-hour log and is automatically cleared when selecting:
 - **Yes to New Patient?** during startup.
 - A different drug from the Drug Library.
 - The same drug with different dosing units from the Drug Library.
 - A new **Therapy** for an mL-based drug.
 - Same patient with a new profile.

Infusion Modes (Continued)

Clear Patient History

1. Press **CHANNEL SELECT** key.
2. From Main Display, press **OPTIONS** key.
3. Press **Patient History** soft key.
4. Press **CLEAR HISTORY** soft key.

A confirmation screen appears.

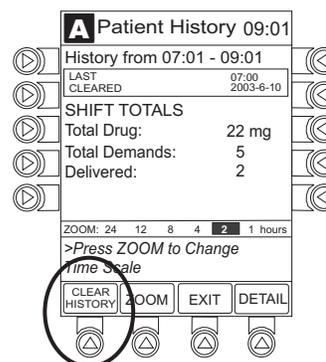

5. To continue and clear patient history, press **Yes** soft key.
To cancel and return to patient history, press **No** soft key.

6. Once patient history is cleared, last 24 hours of patient history data can be retrieved and viewed. To retrieve last 24 hours, select **24 h Totals** soft key from **Patient History** screen.

24 h Totals soft key appears only if shift total is cleared and additional patient history information exists (up to previous 24 hours).



7. To return to **Patient History** screen, press **SHIFT TOTALS** soft key.

Infusion Modes (Continued)

View Drug Event History

1. Press **CHANNEL SELECT** key.
2. From Main Display, press **OPTIONS** key.
3. Press **Drug Event History** soft key.

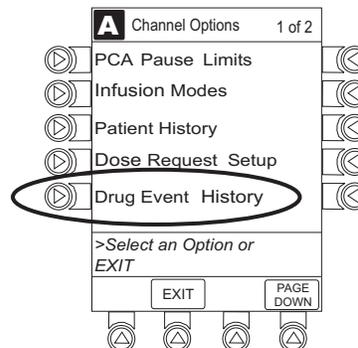

4. To scroll through history, press **PAGE DOWN** soft key. ①
5. To return to Main Display, press **EXIT** soft key.

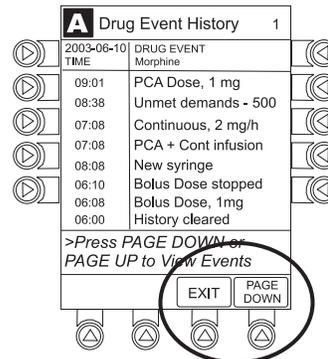

NOTE:

- ① The **Drug Event History** stores approximately 12 hours of events and is automatically cleared upon selection of **New Patient?, Yes** during start-up or upon changing drug in Drug Library.

Configure Dose Request Cord

The Dose Request Cord can be configured to provide both audio and visual prompts to the patient. Visual prompts are provided through the LED indicator on the Dose Request Cord. Default configuration for the Dose Request Cord is established in the system configuration.

To change Dose Request Cord configuration:

1. Press **CHANNEL SELECT** key.

Infusion Modes (Continued)

Configure Dose Request Cord (Continued)

2. From Main Display, press **OPTIONS** key.
3. Press **DOSE REQUEST SETUP** soft key.

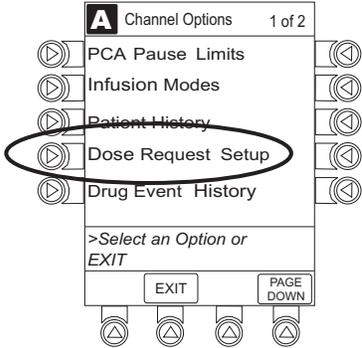

4. Review and select **Profile** soft key for desired operation of Dose Request Cord.

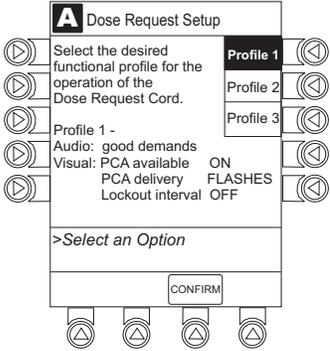

	Profile 1	Profile 2	Profile 3
Dose request cord audio - single beep	met demands only	all demands	all demands
Dose request cord LED indicator:			
PCA available	On	On	Off
PCA delivery	Flashing	On	Off
Lockout interval	Off	On	Off

5. Press **CONFIRM** soft key

Infusion Modes (Continued)

Security Access Levels

The security access level can be configured to provide varying levels of access to the device. Security access is accomplished either through the use of the key or a 4-digit authorization code.

Default configuration for the security access level is established for each profile or care area and can be changed in the system configuration. The 4-digit authorization code is established and can be changed in the system configuration.

The 4-digit authorization code is configured for each profile with Level 2 or Level 3 security access.

Security Access Level	Initial Programming	Setting Bolus Dose	Subsequent Programming
Level 1	Key	Key	Key
Level 2	Key	Code or Key	Key
Level 3	Key	Code or Key	Code or Key

Disable Security Access Code

The security code can be disabled for a specific infusion by using the following procedure:

1. Press **CHANNEL SELECT** key.
2. From Main Display, press **OPTIONS** key.
3. Press **Security Code Access** soft key.

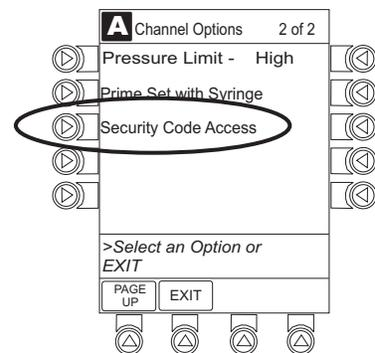

Infusion Modes (Continued)

Disable Security Access Code (Continued)

4. Press **DISABLE CODE** soft key.
5. Press **CONFIRM** soft key.

Security access code remains disabled until **New Patient?, Yes** is selected in infusion startup or when instrument remains powered off for more than 8 hours.

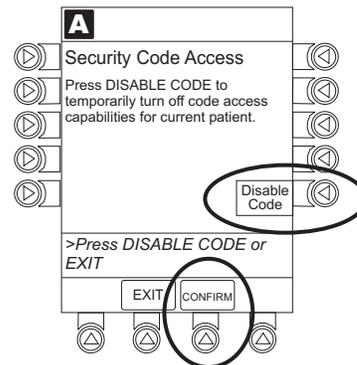

Pause Infusion

1. Press **PAUSE** key.

OR

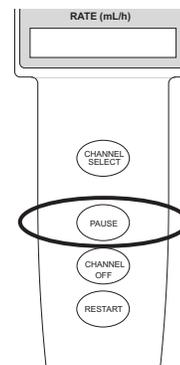

From **Second Nurse Summary** screen, press **PAUSE** soft key.

- **PAUSE** scrolls in Channel Message Display.
- **PAUSED** appears on Main Display.
- Yellow Standby Status Indicator illuminates.
- After 2 minutes, **PAUSE-RESTART CHANNEL** visual and audio prompts begin, and yellow Standby Status Indicator flashes.

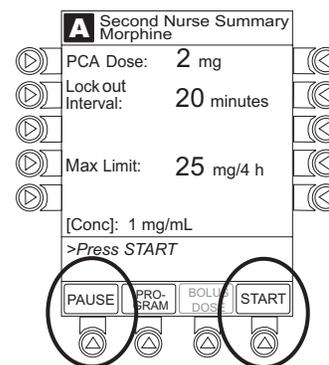

Infusion Modes (Continued)

Pause Infusion (Continued)

- To reinitiate infusion:

Press **RESTART** key.

OR

Press **CHANNEL SELECT** key and then press **START** soft key on Main Display.

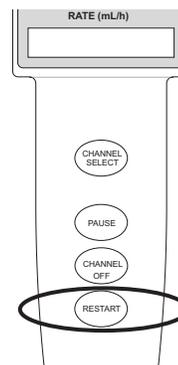

Change Syringe and Restore Infusion

- If syringe requires replacement:

- Unlock security door.
- Remove existing syringe and prepare new syringe (see "Getting Started," "Prepare and Load Syringe and Administration Set").

If drug and/or drug concentration is different from previous syringe, attach and prime new administration set.

- Load syringe and administration set (see "Getting Started," "Prepare and Load Syringe and Administration Set," "Load Syringe and Administration Set").
- Select syringe type and size (see "Prepare Infusion," "Select Syringe Type and Size").

- To restart infusion using restored parameters, press **RESTORE** soft key and continue with next step.

OR

To start a new infusion, select drug from Drug Library and follow steps for "Infusion Modes."

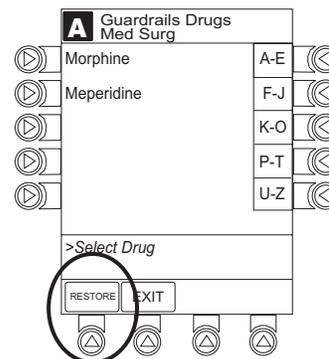

Infusion Modes (Continued)

Change Syringe and Restore Infusion (Continued)

3. Verify restored drug/concentration. Press **NEXT** soft key.
4. Prime administration set (see "Prepare Infusion," "Prime").
5. For restored parameters, verify correct parameters and press **CONFIRM** soft key.

To change a restored parameter:

- a. Press applicable soft key.
 - b. Enter desired parameter using numeric data entry keys.
 - c. Press **CONFIRM** soft key.
6. Close and lock security door.
 7. Verify correct programming parameters on summary screen and press **START** soft key.

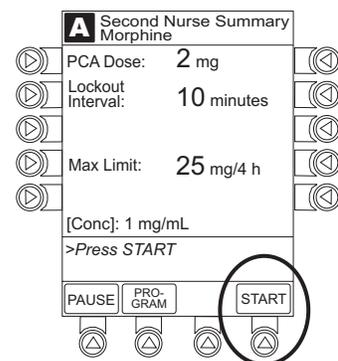

Stop Infusion

Press and hold **CHANNEL OFF** key until a beep is heard, approximately 1.5 seconds. If no other channel is active, the system powers down when the **CHANNEL OFF** key is released.

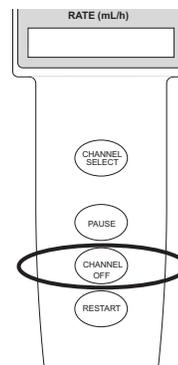

Infusion Modes (Continued)

Select Pressure Limit

1. Press **CHANNEL SELECT** key.
2. Press **OPTIONS** key.
3. Press **Pressure Limit** soft key. ^①

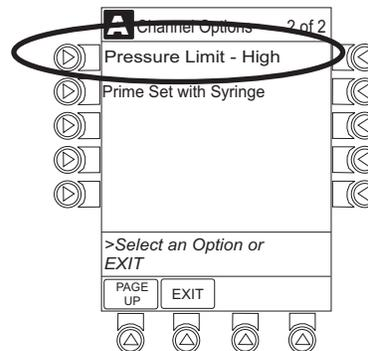

4. To select a pressure limit, press appropriate soft key.
5. Press **CONFIRM** soft key.

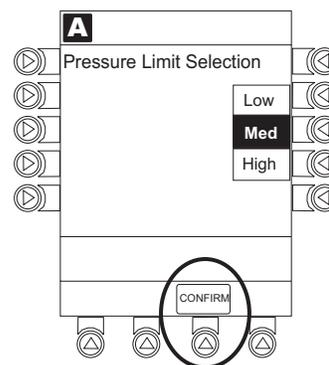

NOTE:

- ^① Option to change pressure limit can be selected:
- after drug is selected, and before infusion mode is selected and infusion starts, or
 - after infusion starts.

View and Clear Volume Infused

1. To view volume infused, press **VOLUME INFUSED** soft key from Main Display.

Total volume infused, and time and date volume infused was last cleared, is displayed for each channel. ^①

Infusion Modes (Continued)

View and Clear Volume Infused (Continued)

- To clear volume infused: ② ③
 - If only selected channels are to be cleared, press soft key next to applicable channel(s) and press **CLEAR CHANNEL** soft key.
 - If all channels are to be cleared, press **CLEAR ALL** soft key.
- To return to main screen, press **MAIN SCREEN** soft key.

NOTES:

- ① Date format is year-month-day.
- ② If no key is pressed, main screen appears after 30 seconds.
- ③ Clearing volume infused on a PCA Module does not clear patient history.

Volume Infused		
	TOTAL VOLUME (mL)	LAST CLEARED
A	401.10	08:00 1998-3-10
B	42.50	07:30 1998-3-11
C	478.10	08:00 1998-3-10
D	789.10	12:00 1998-3-10

>Select Channels to Clear
or Press CLEAR ALL

PRIME VOLUME	CLEAR ALL	MAIN SCREEN
--------------	-----------	-------------

PCA Pause Protocol Feature

The PCA Pause Protocol is an optional, hospital-configurable feature that is intended to align with the healthcare facility's current protocol for patient monitoring during PCA Therapy. All programming, data entry and validation of PCA Pause Protocol parameters are performed by a healthcare professional according to hospital-defined protocol/procedure or a physician's order.

If a monitoring module is not attached or started, the PCA Pause Protocol does not activate.

Program an Infusion

If the PCA Pause Protocol is enabled, perform the following procedure.

- Perform steps 1-8 in "Prepare Infusion," "Program an Infusion."
- Confirm drug and concentration selections and press **Yes** soft key.

PCA Pause Protocol Feature (Continued)

Program an Infusion (Continued)

- Review Clinical Advisory.
 - To continue, press **CONFIRM** soft key.
 - To activate PCA Pause Protocol, attach and start an EtCO₂ Module and/or SpO₂ Module per facility protocol. To continue, press **CONFIRM** soft key.

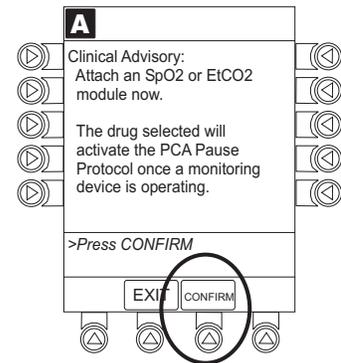

- Verify correct parameters and press **NEXT** soft key to confirm.

Prompt appears.

- Press **CONFIRM** soft key. ^①

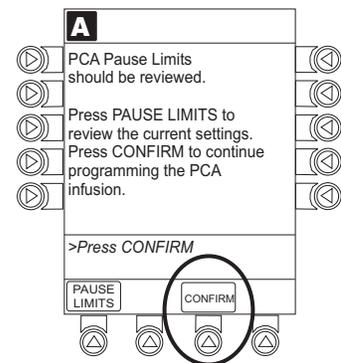

- Start applicable infusion, as described in following procedures: ^②

Set Up PCA Dose Only

Set Up Continuous Infusion Only

Set Up PCA Dose + Continuous Infusion

Set Loading Dose Only

PCA Pause Protocol Feature (Continued)

Program an Infusion (Continued)

NOTE:

- ① To review PCA pause limits, see "Review or Change PCA Pause Alarm Limits."
- ② Once the **START** soft key is pressed, the Main Display screen alternates between volume remaining (VTBI - Volume to be Infused) and PCA drug name with the infusion code.
 - The Main Display displays **PCA Pause Protocol ON**.
 - If Patient ID is entered, **Patient ID** alternates with **PCA Pause Protocol ON**.

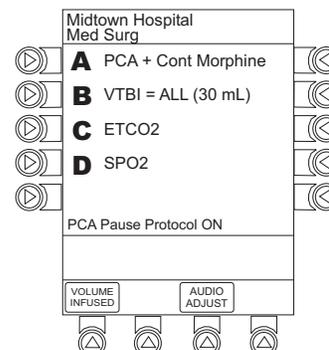

Review or Change PCA Pause Alarm Limits

1. From Main Display press **CHANNEL SELECT**.
2. Press **OPTIONS** key.
3. Press **PCA Pause Limits** soft key.

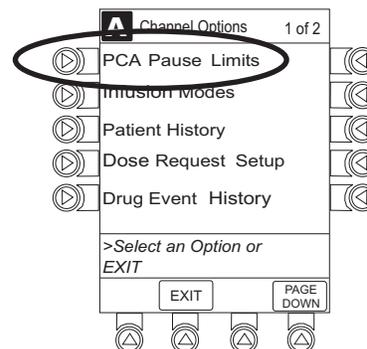

4. Verify that PCA pause limits as per facility protocol or physician order.

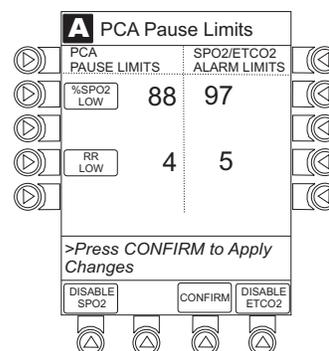

PCA Pause Protocol Feature (Continued)

Review or Change PCA Pause Alarm Limits (Continued)

- To change PCA pause limits, press soft key that corresponds to alarm limit and enter a value within acceptable range. ①

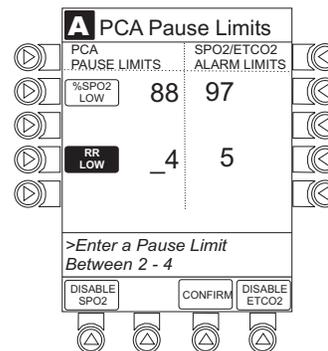

- Press **CONFIRM** soft key.
- Press **START** soft key.

NOTE:

- The acceptable range for PCA Pause Protocol is configurable and defined by the hospital within the Data Set using the Guardrails® Suite MX.

The **PCA PAUSE LIMITS** must be lower than the **SPO2/ETCO2 ALARM LIMITS**. A prompt is provided if the **PCA PAUSE LIMITS** must be modified.

Disable PCA Pause Alarm

- From Main Display press **CHANNEL SELECT**.
- Press **OPTIONS** key.
- Press **PCA Pause Limits** soft key.
- Press **DISABLE SPO2** or **DISABLE ETCO2** soft key, as appropriate.
 - Disabling spO_2 or $EtCO_2$ from this screen discontinues PCA Pause feature only, without interrupting monitoring functionality
 - Once disabled, alarm limits are grayed out and are not editable.

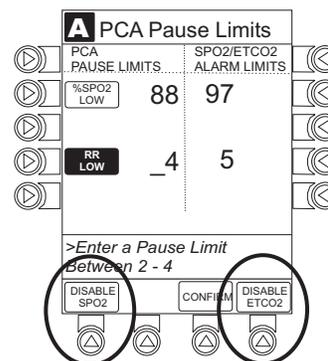

PCA Pause Protocol Feature (Continued)

Disable PCA Pause Alarm (Continued)

5. Press **CONFIRM** soft key.
6. Press **START** soft key.
7. To enable PCA Pause feature, follow steps 1-3 above and press **ENABLE SPO2** or **ENABLE ETCO2** soft key, as appropriate.

General Setup and Operation

Secure to Pole Using Optional Locking Pole Clamp

See the PC Unit section of this DFU if a locking pole clamp is in use and the locking feature is to be used.

System Start-Up/Setup

See the PC Unit section of this DFU, "General Setup and Operation," for various system start-up and setup procedures.

THIS PAGE
INTENTIONALLY
LEFT BLANK

Warnings and Cautions

General

WARNINGS

- The PCA Module is designed to **stop fluid flow under alarm conditions**. Periodic patient monitoring must be performed to ensure that the infusion is proceeding as expected. It is a **positive displacement delivery system**, capable of developing positive fluid pressures to overcome widely varying resistances to flow encountered in practice, including resistances to flow imposed by small gauge catheters, filters and intra-arterial infusion. It is neither designed nor intended to detect infiltrations and does not alarm under infiltration conditions.
- The use of positive displacement infusion devices ported together with **gravity flow infusion** systems into a common IV site can impede the flow of common "gravity only" systems, affecting their performance. Hospital/facility personnel must ensure that the performance of the common IV site is satisfactory under these circumstances.
- **Each time the Alaris® System is turned on**, verify and/or set the monitoring mode, resistance alert, and/or pressure alarm limit. If the monitoring mode, resistance alert, and/or pressure alarm limit are not verified, the instrument might not operate within the desired occlusion detection parameter(s).

Administration Sets

WARNINGS

- Use only standard, single-use, disposable syringes (with luer-lock connectors) and non-dedicated administration sets with integrated anti-siphon valves, designed for use on syringe-type PCA pumps. The use of any other **syringe or administration set** can cause improper instrument operation, resulting in an inaccurate fluid delivery or pressure sensing, or other potential hazards. For a list of compatible syringes, see "Compatible Syringes." For a list of compatible sets, refer to the Set Compatibility Card (provided separately).

Warnings and Cautions (Continued)

Administration Sets (Continued)

WARNINGS

- **Before loading or unloading the syringe**, always turn off fluid flow to the patient, using the tubing clamp or stopcock. Uncontrolled fluid flow can occur when the administration set is not clamped or turned off, and can cause serious injury or death.
- When an occlusion occurs, there is a risk of infusing pressurized buildup of infusates upon correction of the occlusion. To **avoid an inadvertent bolus**, relieve the pressure before restarting the infusion.
- **When priming:**
 - Ensure that patient is not connected.
 - Ensure that air is expelled from line prior to beginning infusion (unexpelled air in line could have serious consequences).

Failure to prime correctly can delay infusion delivery and cause the total volume to be infused to read higher than the actual total delivered to the patient.

- Ensure that the syringe manufacturer and syringe size displayed matches **syringe manufacturer and syringe size installed** in the PCA Module. Mismatches can cause an under-infusion or over-infusion to the patient that could result in serious injury and/or death. For a list of compatible syringes, see "Compatible Syringes."
- **Discard if** packaging is not intact or protector caps are unattached.

CAUTION

Before operating instrument, verify that administration set is **free from kinks and installed correctly** in instrument.

Warnings and Cautions (Continued)

Epidural Administration

WARNINGS

- **Epidural administration** of drugs other than those indicated for epidural use could result in serious injury to the patient.
- It is strongly recommended that the syringe, administration set, and PCA Module used for **epidural drug delivery** be clearly differentiated from those used for other types of administration.
- The Alaris® System can be used for epidural administration of **anesthetic and analgesic drugs**. This application is only appropriate when using anesthetics and analgesics labeled for continuous epidural administration and catheters intended specifically for epidural use. Use only standard or pre-filled, single-use, disposable syringes (with luer-lock connectors) and non-dedicated administration sets with integrated anti-siphon valves, designed for use on syringe-type PCA devices without a 'Y' connector or injection port, for epidural infusions.
 - Epidural administration of **anesthetic drugs**: Use indwelling catheters specifically indicated for short-term (96 hours or less) anesthetic epidural drug delivery.
 - Epidural administration of **analgesic drugs**: Use indwelling catheters specifically indicated for either short-term or long-term analgesic epidural drug delivery.

Dose Request Cord

WARNINGS

- Only the **patient should press** the Dose Request Cord.
- **Carefully locate the Dose Request Cord** to reduce the possibility of patient entanglement or strangulation.

Warnings and Cautions (Continued)

Guardrails® Suite MX

WARNINGS

- The **Guardrails® Suite MX** incorporates dosing limits and instrument configuration parameters based on hospital/facility protocol. The software adds a **test of reasonableness** to drug programming based on the limits defined by the hospital/facility. Qualified personnel must ensure that the appropriateness of drug dosing limits, drug compatibility, and instrument performance, as part of the overall infusion. **Potential hazards** include drug interactions, inaccurate delivery rates and pressure alarms, and nuisance alarms.
- When loading a **Data Set** with the Guardrails® Suite MX, **ensure that the correct profile** (for patient care area) is selected prior to starting an infusion. Failure to use the appropriate profile could cause serious consequences.

Administration Set Information

The PCA Module uses standard, single-use, disposable syringes (with luer-lock connectors) and administration sets with anti-siphon valves, designed for use on syringe-type PCA pumps.

- For specific administration set instructions and set replacement interval, ref to directions for use provided with set.
- For a list of compatible syringes, see "Compatible Syringes."
- For a list of compatible administration sets, refer to Set Compatibility Card (provided separately).
- Use aseptic techniques when handling sets and syringes.
- Administration sets are supplied with a sterile and nonpyrogenic fluid path for one-time use. Do not resterilize.
- Discard administration set per facility protocol.
- For IV push medication (put instrument on hold), clamp tubing above port.
- Flush port(s) per facility protocol.

Compatible Syringes

The PCA Module is calibrated and labeled for use with the following single-use disposable luer-lock syringes. Use only the syringe size and type specified on the Main Display. The full list of permitted syringe models is dependent on the PCA Module's software version.

Syringe variability can impact occlusion pressure sensing. The variability can reduce the device's time to alarm and/or might require that a higher alarm pressure limit be programmed.

Manufacturer	20 mL	30 mL	35 mL	50 mL	60 mL
B-D Plastipak	X	X		X	X
IMS Pump Jet		X ^①			
Monoject	X		X		X
Terumo	X	X		X	X

NOTE:

① Prefilled Morphine Sulfate 1 mg/mL.

Features and Displays

Features and Definitions

See the PC Unit section of this DFU for system features and definitions.

Feature	Definition
Auto Pressure Limit Adjustment	When a bolus is delivered, pressure alarm limits are temporarily raised to maximum limit.
Auto Syringe Identification	System automatically detects syringe size and narrows down syringe selection list.
Bolus Delivery Rate	Rate at which PCA, bolus, and loading doses (boluses) are infused.
Bolus Dose	Allows an additional amount of medication to be programmed once PCA infusion has begun. Current PCA infusion resumes following delivery of a bolus dose.

Features and Displays (Continued)

Features and Definitions (Continued)

Feature	Definition										
Concentration	<p>Drug amount per volume of fluid. For example, a 30 mL syringe with a concentration of 1 mg/1 mL can be entered in one of two ways:</p> <table style="margin-left: 40px;"> <tr> <td>Drug Amount</td> <td>1 mg</td> </tr> <tr> <td>Diluent Volume</td> <td>1 mL</td> </tr> <tr> <td colspan="2" style="text-align: center;">OR</td> </tr> <tr> <td>Drug Amount</td> <td>30 mg</td> </tr> <tr> <td>Diluent Volume</td> <td>30 mL</td> </tr> </table>	Drug Amount	1 mg	Diluent Volume	1 mL	OR		Drug Amount	30 mg	Diluent Volume	30 mL
Drug Amount	1 mg										
Diluent Volume	1 mL										
OR											
Drug Amount	30 mg										
Diluent Volume	30 mL										
Continuous Dose	Basal rate dose.										
Dose Request Cord	Allows a patient to self-administer a PCA dose, to be delivered according to programmed PCA parameters ("PATIENT USE ONLY" label is available for optional attachment to cord). Dose Request Cord features an indicator light which can be configured to provide feedback to patient on requested PCA doses. Dose Request Cord is enabled in PCA only and PCA + continuous modes.										
Drug Event History	Records and displays sequential device events for a typical 12 hours, subject to change upon usage and number of modules.										
Drug Library	When Profiles feature is enabled, it provides a hospital-defined list of drugs and concentrations appropriate for use in as many as ten profiles. Drug Library use automates programming steps, including drug name, drug amount, and diluent volume, and activates hospital-established best-practice limits. A Data Set that includes a Drug Library is required prior to using PCA Module.										
Event Logging	Event Logging records instrument operations.										
Initial Value	An optional and editable starting value for PCA dose, continuous dose, lockout interval, or maximum limit.										
Limit	<p>A programming Limit or best-practice guideline determined by hospital/health system and entered into system's Data Set. Dose Limits can be defined by hospital/health system as Hard or Soft Limits.</p> <ul style="list-style-type: none"> • A Hard Limit is a programmed Limit that cannot be overridden. • A Soft Limit is a programmed Limit that can be overridden. 										
Loading Dose	Allows a bolus infusion to be programmed prior to initiation of PCA infusion. Can be programmed from Infusion Modes menu or applicable PCA, PCA + continuous, or continuous only programming screen prior to start of a new PCA infusion program.										

Features and Displays (Continued)

Features and Definitions (Continued)

Feature	Definition
Lockout Interval	Allows programming of a predetermined interval of time that must elapse between delivery of PCA doses.
Max Dose Limit (Max Accumulated Dose Limit)	<p>Optional configuration that limits total amount of drug allowed to be delivered to patient in a defined period (1, 2, or 4 hours).</p> <ul style="list-style-type: none"> • Should be configured in Data Set before Drug Library is developed. Once drugs are in Profile PCA Drug Library, Max Accumulated Dose Limit cannot be changed. • Applies to all drug setups within Profile PCA Drug Library.
Module Location Enforcement	Tamper resistant security feature that ensures PCA Module is in a tamper evident position. When enabled, PCA Module must be located to direct right of PC Unit to allow programming an infusion.
Near End of Infusion (NEOI)	Allows an alert to be configured to sound anywhere between 5 – 25% volume remaining.
NEOI Alert	Alert Time can be set to occur when 5 – 25% of VTBI remains.
Occlusion Pressure	Downstream occlusion alarm threshold can be set to low, medium, or high.
Operating Modes	<p>Four operating modes are available:</p> <ul style="list-style-type: none"> • PCA only • continuous infusion • PCA + continuous infusion • loading dose only <p>All programming of infusions in each of four modes are completed using Drug Library as defined by hospital-established best-practice.</p>
Patient History	<p>PCA Module records and displays patient history for up to 24 hours, and can be trended to following intervals: 1-hr, 2-hr, 4-hr, 8-hr, 12-hr, 24-hr. Patient history includes following trending information:</p> <ul style="list-style-type: none"> • total demands • delivered demands • total drug delivered • time and date patient history last cleared • average drug per hour • total amount of drug delivered via: <ul style="list-style-type: none"> ◦ PCA dose ◦ continuous infusion ◦ loading dose ◦ bolus dose

Features and Displays (Continued)

Features and Definitions (Continued)

Feature	Definition
PCA Dose	Enables a patient to self-administer a bolus infusion to be delivered at programmed lockout intervals through Dose Request Cord. When programmed in PCA+continuous mode, continuous infusion resumes following PCA dose.
PCA Pause Protocol	An optional and hospital-configurable feature intended to align with hospital/health system's current protocol for patient monitoring during PCA therapy. When enabled, PCA infusion pauses and alarms when defined monitoring values (% SpO ₂ and/or Respiratory Rate low) for SpO ₂ and/or EtCO ₂ Modules are reached.
Pressure Limit	Downstream occlusion alarm threshold can be set to low, medium, or high. Syringe variability might impact occlusion pressure sensing. Variability can reduce device's time to alarm and/or can require that a higher alarm pressure limit be programmed.
Priming	Allows a limited volume of fluid to be delivered in order to prime administration set prior to being connected to a patient or after changing a syringe. When priming, a single continuous press of PRIME soft key delivers up to 2 mL of priming/fluid.
Restore	To simplify programming, can be used to recall previous PCA programming parameters for same patient. This option is only available if patient is not new and system is powered up within 8 hours of last usage.
Security Access Level	Profile-specific security access level can be configured to provide varying levels of access to device. Security access is accomplished either through use of key or a 4-digit authorization code. For security level information, see "Programming," "Infusion Modes," "Security Access Levels."
Security Code	Four-character code assigned to allow access to PC Unit for setting bolus doses and subsequent programming changes. Ability to use profile-specific code is dependent upon configured Security Access Level.
Syringe Empty	Instrument gives an alert and stops when an empty syringe is detected.
Syringe Volume Detection	System automatically detects fluid volume in a syringe when it is inserted.

Features and Displays (Continued)

Features and Definitions (Continued)

Feature	Definition
Therapies	An optional hospital-defined therapy or clinical indication for delivery of that infusion. Different Limits can be defined for same medication with different therapeutic indications.
Time Window (h)	1, 2, or 4 hours.

Features and Displays (Continued)

Operating Features, Controls, Indicators

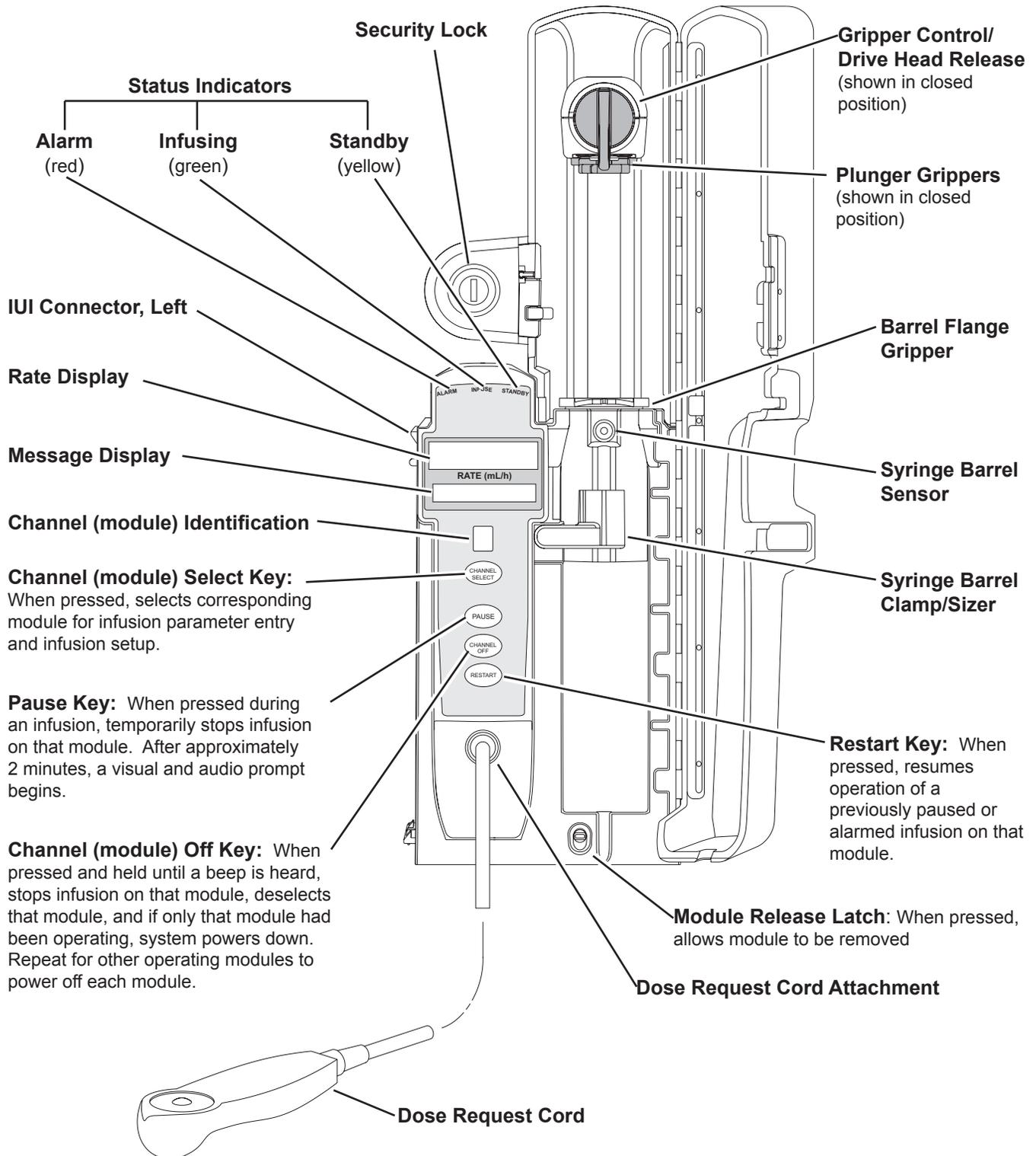

Features and Displays (Continued)

Displays

The displays illustrated throughout this document are for illustration purposes only. The display content varies, depending on configuration settings, type of administration set in use, hospital-defined Data Set uploaded using the Guardrails® Suite MX, programmed drug calculation parameters, and many other variables. Refer to specific drug product labeling for information concerning appropriate administration techniques and dosages.

Configurable Settings

See the PC Unit section of this DFU for system configurable settings.

The configuration settings are selected during Data Set development and then uploaded to the Alaris® System as part of the data.

With the Profiles feature enabled, the settings are configured independently for each profile. A hospital-defined, best-practice Data Set must be uploaded to enable the Profiles feature. Date and Time is a system setting and is the same in all profiles.

Feature	Default Setting	Options
Authorization Code	None	4 digits (0 - 9) One code applies to all profiles
Bolus Delivery Rate	150 mL/h	75 - 500 mL/h (limited by syringe size)
Bolus Dose	Enabled	Enabled - Disabled
Bolus Dose include in Max. Limit	Disabled	Enabled - Disabled
Dose Request Cord Configuration	Profile 2	Profile 1, 2, 3
Forced Module Location	Enabled	Enabled - Disabled
Loading Dose	Enabled	Enabled - Disabled
Lockout Interval	1 - 99 minutes in 1-minute increments	Min/Max 1 - 99 minutes
Max Accumulated Dose Range	1-hour limit	Disabled; 1, 2, or 4-hour limit

Configurable Settings (Continued)

Feature	Default Setting	Options
Max Rate (for Continuous Dose) ^①	999 mL/h	0.1 - 99.9 mL/h in 0.1 mL/h increments; 100 - 999 mL/h in 1 mL/h increments
NEOI • Alert Time	Disabled	Enabled - Disabled 5 - 25% of remaining infusion
Occlusion Pressure Set Point	High (800 mmHg)	Low (200 mmHg) Medium (500 mmHg) High (800 mmHg)
PCA Pause Protocol • PCA Pause Protocol • Monitoring Module Attach Enforcement • PCA Pause Protocol Text • SpO ₂ Settings ^② ◦ % SpO ₂ Low Limit ◦ Initial Value • EtCO ₂ Settings ^③ ◦ Respiratory Rate Lower Limit (bpm) ◦ Initial Value	Disabled None PCA infusion has paused due to a decline in respiratory status. Check patient. None None None None	Enabled - Disabled Enabled - Disabled Editable per hospital protocol 20 - 99 20 - 99 0 - 149 0 - 149
Priming	Disabled	Enabled - Disabled
Security Access Level	Level 1	Level 1, 2, 3

NOTES:

- ① This configuration setting is a shared setting between the PCA Module and the Syringe Module.
- ② These values are configured in the SpO₂ Module settings within the Editor Software and can be changed by the clinician by accessing Channel Options on the PCA Module.
- ③ These values are configured in the EtCO₂ Module settings within the Editor Software and can be changed by the clinician by accessing Channel Options on the PCA Module.

Specifications and Symbols

Specifications

Bolus Dose Range: Configured according to hospital best-practice guidelines.

Bolus Volume, Maximum after Occlusion:

Occlusion Pressure Limit	Bolus Volume (mL)
Low	0.994
High	0.396

Maximum Bolus Volume specifications are based on following standard operating conditions:

Atmospheric Pressure: 645 - 795 mmHg
 Disposable Type: #30883
 Humidity: 20 - 90%
 Rate: 5 mL/h
 Syringe Type: BD 50/60 mL
 Temperature: 68 ±4°F
 Volume Collection Time: approximately 2 minutes

Critical Volume: Maximum over-infusion which can occur in the event of a single-fault condition will not exceed 2% of nominal syringe fill volume during loading and 1% of maximum syringe travel after syringe loading.

Delivery Units: mcg, mcg/h, mg, mg/h, mL, mL/h

Dimensions: 4.5" W x 15.0" H x 7.5" D (exclusive of security door)

Environmental Conditions:

	Operating	Storage/Transport
Atmospheric Pressure	525 - 4560 mmHg (700 - 6080 hPa)	375 - 760 mmHg (500 - 1013 hPa)
Relative Humidity (Avoid prolonged exposure to relative humidity >85%)	20 - 90% Noncondensing	5 - 85% Noncondensing
Temperature Range	41 - 104°F (5 - 40°C)	-4 - 140°F (-20 - 60°C)

Equipment Orientation: To ensure proper operation, Alaris® System must remain in an upright position.

Specifications and Symbols (Continued)

Specifications (Continued)

Flow Rate Programming: Flow rate range is from 0.01 to 999 mL/h and can be selected as follows:

Flow Rates (mL)	Selectable Increments (mL/h)
0.10 - 9.99	0.01
10 - 99.9	0.1
100 - 999	1.0

Rate Restriction by Syringe Size:

Syringe Size (mL)	Flow Rate Range (mL/h)
20	0.1 - 500
30/35	0.1 - 650
50/60	0.1 - 999

Fluid Ingress Protection: IPX1, Drip Proof

Loading Dose Range: Configured according to hospital best-practice guidelines.

Maximum Dose Range: Configured according to hospital best-practice guidelines.

Occlusion Alarm Thresholds: Three settings:
Low
Medium
High

Operating Principle: Positive displacement

PCA Dose Range: Configured according to hospital best-practice guidelines.

Rate Accuracy: $\pm 2\%$ of full scale plunger travel (not including syringe variation)

WARNING

Syringe size and running force, variations of back pressure, or any combination of these **can affect rate accuracy**. Factors that can influence back pressure are: Administration set configuration, IV solution viscosity, and IV solution temperature. Back pressure can also be affected by type of catheter. See "Trumpet and Start-Up Curves" for data on how these factors influence rate accuracy.

Shock Protection: Type CF, Defibrillator Proof (PCA Module)
Type BF, Defibrillator Proof (Dose Request Cord)

Specifications and Symbols (Continued)

Specifications (Continued)

Time to Alarm, Maximum:

Rate (mL/h)	High	Low
1	120 minutes	37 minutes
5	30 minutes	7 minutes

Maximum Time to Alarm specifications are based on following standard operating conditions:

Atmospheric Pressure: 645 - 795 mmHg
 Back Pressure: 0 mmHg before producing occlusion
 Disposable Type: #30883
 Humidity: 20 - 90%
 Syringe Type: BD 50/60 mL
 Temperature: 68 ±4°F

Weight: 5.5 lbs

Symbols

See the PC Unit section of this DFU for system symbols.

Symbol	Meaning
	Type CF, defibrillation-proof (PCA Module).
	Type BF, defibrillation-proof (Dose Request Cord).
	Manufacturer
Single-Use 	Single-Use. Do not re-use.
	DEHP in fluid pathway.
	Non-DEHP plasticizer in fluid pathway.
	No DEHP in fluid pathway.

Specifications and Symbols (Continued)

Symbols (Continued)

Symbol	Meaning
	Product is latex-free.
	Approximate administration set priming volume.
	Expiration date for product is identified near hour glass symbol.
	Do not use if package is damaged.
	Product contains micron filter, where xx represents filter size.

Trumpet and Start-Up Curves

In this instrument, as with all infusion systems, the action of the pumping mechanism and variations in individual syringes and administration sets cause short-term fluctuations in rate accuracy. The following graphs show typical performance of the system, as follows:

- Accuracy during various time periods over which fluid delivery is measured (trumpet curves).
- Delay in onset of fluid flow when infusion commences (start-up curves).

Trumpet and start-up curves have been provided for 0.1 mL/h, 1.0 mL/h and 5.0 mL/h. Measurements for trumpet curve rates above 5.0 mL/h are also not provided, as the syringe volume is displaced in a very short time with a rate up to 999 mL/h. Accuracy, however, is assured with the design implementation.

Trumpet curves are named for their characteristic shape. They display discrete accuracy data

averaged over particular time periods or "observation windows," not continuous data versus operating time.

Over long observation windows, short-term fluctuations have little effect on accuracy, as represented by the flat part of the curve. As the observation window is reduced, short-term fluctuations have greater effect, as represented by the "mouth" of the trumpet. Knowledge of system accuracy over various observation windows might be of interest when certain drugs are being administered.

Because the clinical impact of short-term fluctuations on rate accuracy depends on the half-life of the drug being infused and on the degree of intravascular integration, the clinical effect cannot be determined from the trumpet curves alone. Knowledge of the start-up characteristics should also be considered.

Trumpet and Start-Up Curves (Continued)

The start-up curves represent continuous flow rate versus operating time for two hours from the start of the infusion. They exhibit the delay in onset of delivery due to mechanical compliance and provide a visual representation of uniformity. Trumpet curves are derived from the second hour of this data.

Under conditions of -100 mmHg, +100 mmHg, and +300 mmHg pressures, the PCA Module typically exhibits a long-term accuracy offset of approximately 0.2% or less from the mean value.

Trumpet and Start-Up Curves (Continued)

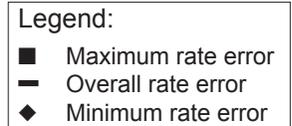
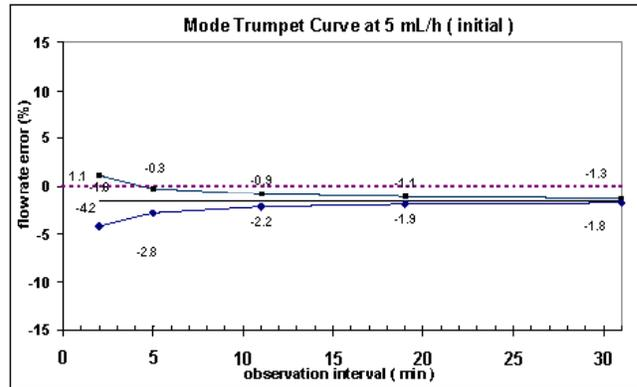
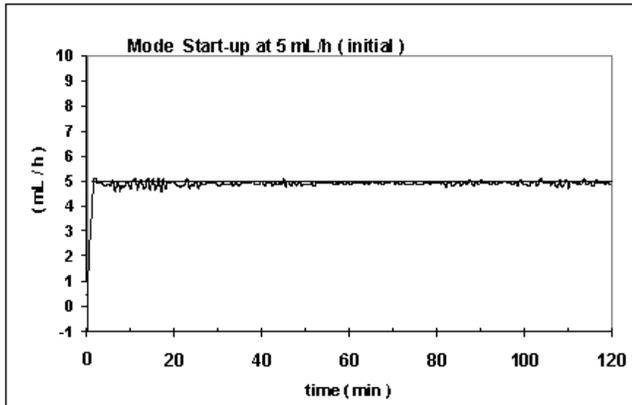
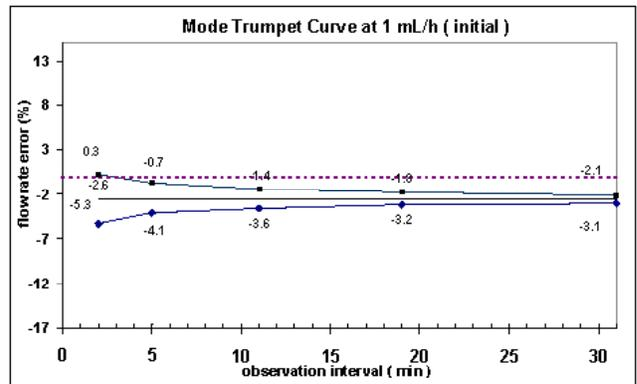
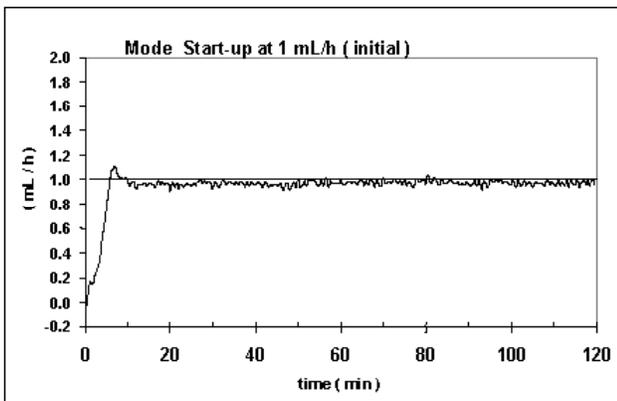
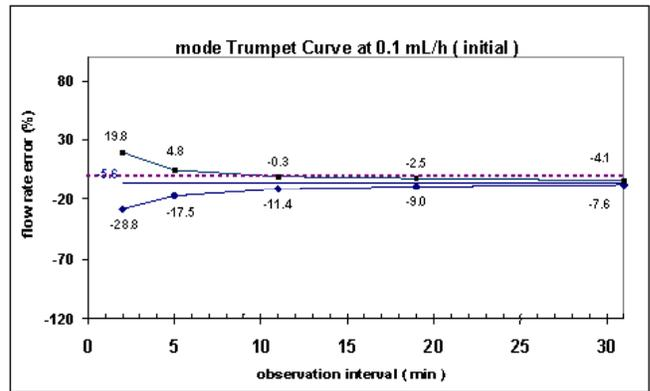
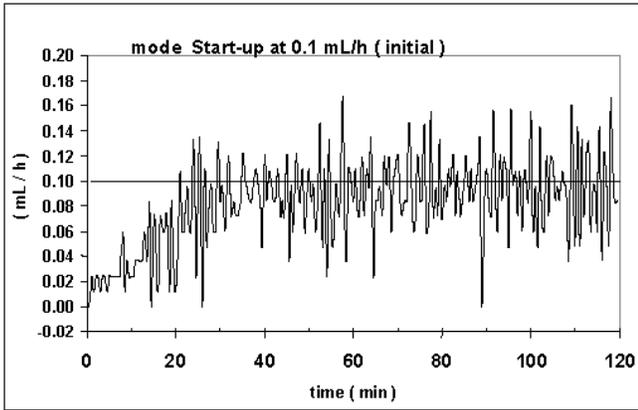

Troubleshooting and Maintenance

General

Troubleshooting and maintenance are intended to be performed only by qualified personnel, using the PCA Module Technical Service Manual and the System Maintenance software. The Service Manual and System Maintenance software are available from CareFusion. The Service Manual includes routine service schedules, interconnect diagrams, component parts lists and descriptions, test procedures, and other technical information to assist qualified service personnel in repair and maintenance of the instrument's repairable components. The System Maintenance software is used to perform a new instrument check-in, preventive maintenance tests, calibration checks, calibration, and other maintenance functions.

Artifacts: It is normal for an infusion device to produce nonhazardous currents when infusing electrolytes. These currents vary proportional to the infusion device flow rate. When an ECG monitoring system is not functioning under optimal conditions, these currents might appear as artifacts, simulating actual ECG readings. To determine if ECG abnormalities are caused by patient condition or the ECG equipment, place the infusion device on hold. If the ECG readings become normal, the ECG equipment requires attention. Proper setup of the ECG equipment should eliminate these artifacts. Refer to the appropriate ECG monitoring system documentation for instructions on setup and maintenance.

Alarms, Errors, Messages

See the PC Unit section of this DFU for the following system references:

- Alarms, Errors, Messages
- Audio Characteristics
- Definitions
- Radio Frequency Note

Alarms, Errors, Messages (Continued)

Definitions

Alert A visual message to help reduce programming errors by indicating a Limit (Soft or Hard) has been exceeded. A response is required before programming can continue.

Clinical Advisory A visual message defined by the facility for a designated drug and displayed when that drug is selected for an infusion. The message provides instructions related to specific drug use and/or facility standards of practice when programming an IV medication. A specific Clinical Advisory and/or message can be associated with a selected drug within any of the patient care profiles. Clinical Advisories are not displayed in Anesthesia mode.

Alarms

Alarm	Meaning	Response
Attach Dose Request Cord	Dose Request Cord detached from device. Dose Request Cord required for PCA only and PCA + continuous infusion modes.	Reattach Dose Request Cord and press RESTART key.
Channel Disconnected	Module disconnected while in operation or have a communication problem.	To silence alarm and clear message from screen, press CONFIRM soft key. Reattach module, if desired, ensuring it is securely "clicked" into place at Channel Release Latch. If alarm is still present, replace module.
Lock Door	Door unlocked during infusion (system does not infuse with door unlocked).	Lock door and press RESTART key.
Occlusion	Increased back pressure sensed while infusing. Infusion stops on affected module.	Clear occlusion. Press RESTART key, or press CHANNEL SELECT key and then START soft key.
PCA Pause Alarm	PCA infusion has paused due to a decline in respiratory status.	Assess patient status per hospital policy. Press CONFIRM once patient status and monitoring values have been addressed. Press RESTART key per hospital policy.

Alarms, Errors, Messages (Continued)

Alarms (Continued)

Alarm	Meaning	Response
Syringe Empty	<p>Syringe is empty.</p> <p>If syringe is not empty, other possibility is: Syringe plunger travel impeded.</p>	<p>Set up new infusion or press CHANNEL OFF key.</p> <p>Verify that syringe plunger movement is unimpeded.</p> <p>If syringe is not empty and above actions do not correct alarm, replace module.</p>

Syringe Adjustment Alarms

When a syringe installation problem is detected, a visual signal is displayed. Text in the display blinks to indicate the location of the problem.

When problem is corrected, press **CONFIRM** soft key.

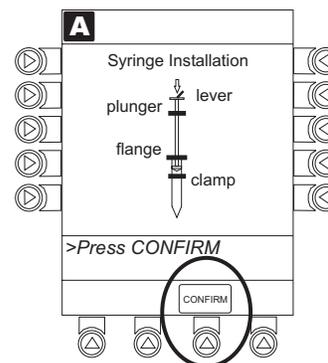

Alarm	Meaning	Response
Check Syringe	<p>Plunger grippers opened during infusion and then closed. Infusion stops on affected module.</p> <p>Syringe barrel clamp opened during infusion and then closed. Infusion stops on affected module.</p> <p>Syringe plunger not captured while in idle state. System alarms after 30 seconds to indicate potential siphoning condition.</p>	<p>Securely lock plunger grippers, press CHANNEL SELECT key, and reselect syringe.</p> <p>Securely lock syringe barrel clamp and press RESTART key.</p> <p>Check for potential siphoning. Ensure that administration set clamp (roller/slide) is in closed position. Securely lock plunger grippers over syringe plunger.</p>
Drive Not Engaged	Drive system disengaged during operation.	Open and close plunger grippers and syringe barrel clamp. Ensure that syringe is properly installed.

Alarms, Errors, Messages (Continued)

Errors

Error	Meaning	Response
Channel Error	Error detected. Operation stops on affected module.	To silence alarm and continue operation of unaffected module(s), press CONFIRM soft key. Replace module, as needed.
Syringe Calibration Required	Error on infusing module indicating calibration is required. Infusion stops on affected module. CALIBRATE scrolls in Message Display.	To silence alarm and continue operation of unaffected module(s), press CONFIRM soft key. Replace module, as needed.
Syringe Driver Head Error	Noninfusing module, with plunger grippers open, senses excessive pressure being applied downward on Drive Head. OCCCLUSION scrolls in Message Display.	To silence alarm and continue normal operation, press CONFIRM soft key.

Messages

Message	Meaning	Response
Bolus Complete	Current bolus dose completed. Channel running in continuous dose if programmed.	None
Incorrect concentration or dosing	An incorrect concentration or dose parameter is programmed.	<ol style="list-style-type: none"> 1. Remove syringe. 2. Verify that concentration listed on syringe matches concentration (DRUG AMOUNT and DILUENT VOLUME) programmed into PCA Module. 3. Reprogram.
Infusion Complete	Current infusion completed.	Set up a new infusion or press CHANNEL OFF key.
Load Complete	Current loading dose completed. Infusion mode menu available or programmed infusion running.	None

Alarms, Errors, Messages (Continued)

Messages (Continued)

Message	Meaning	Response
Max Limit Reached	Programmed maximum limit has been reached over time period specified. Infusion paused until time limit has expired.	To silence alarm, press SILENCE key. To change Max Limit , press CHANNEL SELECT , press PROGRAM soft key, and unlock door or enter Authorization Code applicable for current Security Access Level.
NEOI (Near End of Infusion)	Syringe almost empty.	This is a timed event that can be set or changed (see "General Information," "Configurable Settings"). To silence alarm, press SILENCE key. PCA Module remains functional and continues infusion. Green indicator light is lit (when programmed in PCA Dose plus continuous mode) or flashes (when programmed in PCA Dose only), and yellow light flashes. PCA Module is silent until Syringe Empty alarm sounds (see Syringe Empty alarm response)
Panel Locked	Tamper Resist feature is active and a key was pressed.	If appropriate, deactivate Tamper Resist feature using Tamper Resist Control on back of PC Unit.
Panel Unlocked	Tamper Resist feature deactivated.	None
Pause	Pause control pressed; infusion stopped.	To resume infusion, press RESTART key, or press CHANNEL SELECT key and then START soft key.
PCA Complete	Current PCA dose complete. Channel running in continuous dose if programmed.	None
PCA Not In Secure Location	PCA Module is not in preferable location to allow locking to PC Unit. Device is not in a tamper evident position.	Detach PCA Module from current position and reattach to immediate right of PC Unit.
Syringe Not Recognized	Installed syringe of unknown type and size.	Select and confirm correct syringe type and size, and then press CONFIRM soft key, or use a syringe type and size that system can automatically and correctly identify.

Inspection Requirements

To ensure that the Alaris® System remains in good operating condition, both regular and preventive maintenance inspections are required. Refer to the System Maintenance software for detailed instructions.

REGULAR INSPECTIONS

PROCEDURE	FREQUENCY
INSPECT FOR DAMAGE: <ul style="list-style-type: none">• Exterior Surfaces• IUI Connector• Keypad• Mechanical Parts	<ul style="list-style-type: none">• Each usage• Each usage• Each usage• Each usage
CLEANING	As required
START-UP	Each usage

WARNING

Failure to perform these inspections can result in improper instrument operation.

CAUTION

Preventive maintenance inspections should only be performed by qualified service personnel.

Alaris® SpO₂ Modules Models 8210 and 8220



Getting Started

Introduction	4-1
Attach Cable and Sensor	4-2

Programming

Monitoring Mode	4-3
Set Alarm Limits	4-4
Navigate Trend Data	4-5
Navigate PCA/SpO ₂ Trend Data	4-6
Presilence Alarm	4-7
Channel Options	4-8
Change Limit Mode	4-8
Change Pulse Beep Volume	4-8
Change SatSeconds™ Limit	4-9
Change Saturation Averaging Time	4-10
Change Sensitivity Mode	4-10

General Setup and Operation

System Start-Up/Setup	4-13
-----------------------------	------

General Information

Warnings and Cautions	4-15
General	4-15
Sensors and Cables	4-16
Cables and Sensors	4-17
Nellcor® Patient Cables and OxIMAX® Sensors	4-17
Masimo® Patient Cables and Sensors	4-17
Features and Displays	4-18
Features and Definitions	4-18
Operating Features, Controls, Indicators	4-21
Displays	4-22
Configurable Settings	4-23
Specifications and Symbols	4-24
Specifications	4-24
Symbols	4-27
Measurement Accuracy	4-27

Troubleshooting and Maintenance

General	4-29
Alarms and Messages	4-29
Definition	4-29
Alarms	4-29
Messages	4-31
Inspection Requirements	4-33

THIS PAGE
INTENTIONALLY
LEFT BLANK

Introduction

This section of the DFU provides SpO₂ Module (Models 8210 and 8220) instructions and information. It is used in conjunction with:

- Nellcor® and Masimo® cable and sensor instructions
- PC Unit section of this DFU
- SpO₂ Module sensor and cable Compatibility Cards
- SpO₂ Module Technical Service Manual
- System Maintenance software (and its instructions) for Alaris® System check-in, maintenance, and wireless configuration

The SpO₂ Modules are indicated for continuous, noninvasive monitoring of functional oxygen saturation of arterial hemoglobin (SpO₂) and pulse rate measured by an SpO₂ sensor. The SpO₂ Modules and accessories are indicated for use with adult, pediatric and neonatal patients, and for patients who are well or poorly perfused in hospitals and hospital-type facilities. The Model 8220 SpO₂ Module is also indicated for use during motion and no motion conditions. Only one SpO₂ Module can be connected to the Alaris® System.

The majority of user interface programming is identical for both SpO₂ Modules. If a procedure/information applies to a specific module, the following identifiers indicate the applicable model.

Model 8210:  **NELLCOR**
(8210)

Model 8220:  **MASIMO SET**
(8220)

Cables and Sensors: See "General Information" for "Cables and Sensors" information.

Alarms and Messages: See "Troubleshooting and Maintenance" for module-specific "Alarms and Messages."

Contraindications: The SpO₂ Modules are contraindicated for use as apnea monitors.

Electromagnetic Environment: See "Appendix" section of this DFU ("Regulations and Standards," "Compliance").

WARNING

Read all instructions, for the SpO₂ Modules and PC Unit, before using the Alaris® System.

CAUTION

Rx Only

Attach Cable and Sensor

1. Attach applicable patient cable to SpO₂ Module. Ensure secure connection and patient cable is not twisted, sliced or frayed.
2. Attach applicable sensor to patient cable. Refer to sensor's directions for use for detailed instructions.

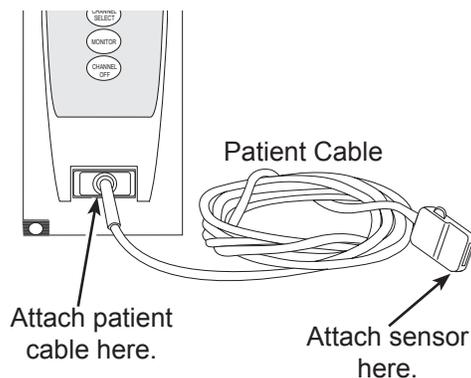

3. Attach sensor to patient. Refer to sensor's directions for use for detailed instructions.

WARNING

Model 8210:

Use only approved OxiMAX[®] sensors, and DOC-10 and OC-3 pulse oximetry cables.

Model 8220:

Use only approved Masimo[®] sensors and patient cables.

Use of sensors, transducers, cables and accessories other than those specified can cause improper SpO₂ Module performance resulting in inaccurate readings, increased emission and/or decreased immunity, and degraded electromagnetic compatibility performance of the SpO₂ Module. For a list of compatible sensors and cables, refer to the Sensor and Cable Compatibility Card (provided separately).

Display references throughout this procedure are for illustration purposes only.

See "General Information," "Features and Displays" and the PC Unit section of this DFU for information about:

- Displays
- Operating Features, Controls, Indicators

The majority of user interface programming is identical for both SpO₂ Modules.

Monitoring Mode

1. Perform following steps (see PC Unit section of this DFU, "General Setup and Operation," "Start-Up"):
 - a. Power on system.
 - b. Choose **Yes** or **No** to **New Patient?**
 - c. Confirm current profile or select a new profile.
 - d. Enter patient identifier, if required.
2. Attach patient cable and sensor (see "Getting Started").
3. Press **CHANNEL SELECT** key.
 - **SEARCHING** might appear in Channel Message display until SpO₂ and pulse readings stabilize (approximately 15 seconds).
 - If sensor is not attached to a site, **SENSOR OFF** is displayed.
 - To prevent screen from reverting to Main Display, press **ENTER** key within 30 seconds after **SPO2 Main** screen is displayed.
 - If sensor is not attached during message display, module goes into sleep mode. To begin monitoring once module is in this mode, press **MONITOR** key.
4. Ensure that sensor's red LED is on.

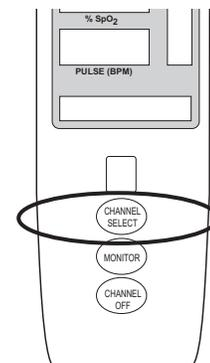

Monitoring Mode (Continued)

5. Alarm limits:

- To change settings, see "Set Alarm Limits" procedure.

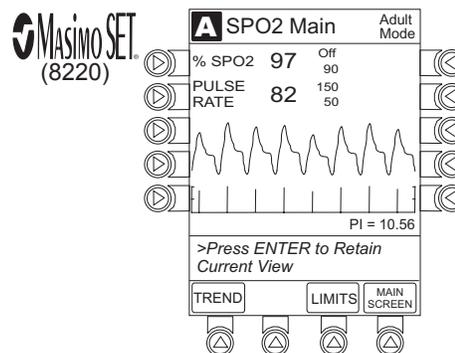
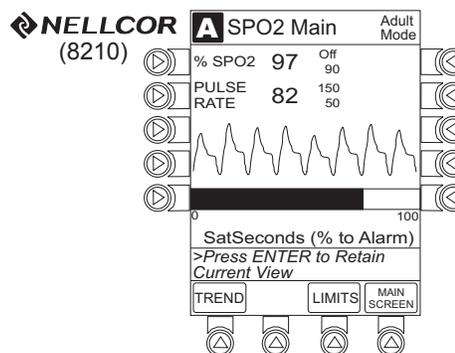

- To accept settings and begin monitoring, press **ENTER** key.

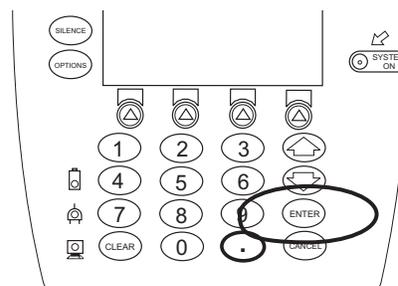

Set Alarm Limits

1. Press **LIMITS** soft key.

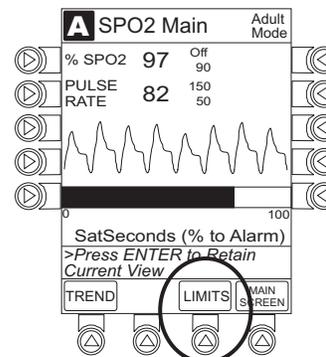

Monitoring Mode (Continued)

Set Alarm Limits (Continued)

- To change a limit setting, press soft key next to applicable parameter.

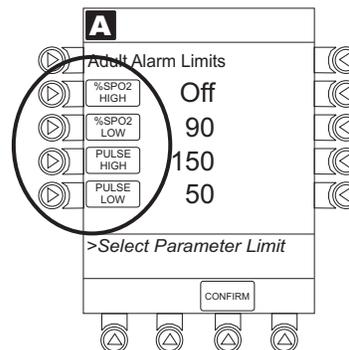

- Enter a numeric value for selected alarm limit.
%SPO2 HIGH limit can be **Off** or a numeric value.
- To move to next limit, press **ENTER** key.
- To confirm alarm settings and return to **SPO2 Main** display, press **CONFIRM** soft key.

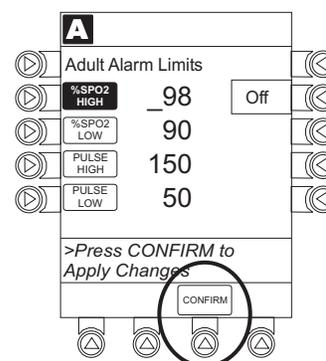

- To return to Main Display, press **MAIN SCREEN** soft key.

Navigate Trend Data

- To view **Trend Data**, press **TREND** soft key.
 - Tabular information is not updated while **Trend Data** view is displayed. Tabular data is updated, using new trend data stored in SpO₂ Module, after leaving **Trend Data** view. To view latest data, return to **Trend Data** view.
 - ⚠ is displayed if an alarm limit is reached.
 - If no **SPO2** or **PULSE** rate values are available for time period displayed, dashes (---) display.
- To navigate from page to page, press **PAGE UP** and **PAGE DOWN** soft keys.

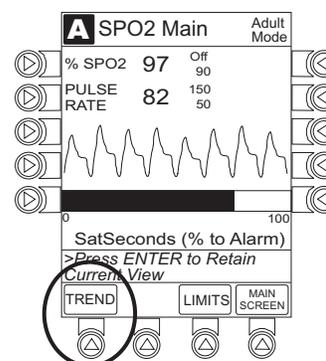

Monitoring Mode (Continued)

Navigate Trend Data (Continued)

3. To scroll data one row at a time, press  or  key.

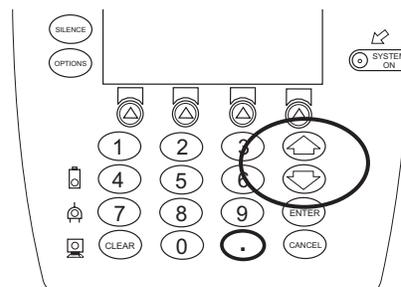

4. To change **TIME** increments for data review, move cursor to desired time period and press **ZOOM** soft key.

- New time increments display.
- Each press of **ZOOM** soft key changes time increments.

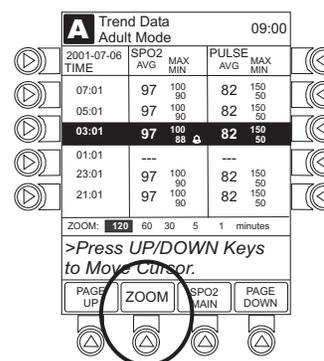

5. To return to **SPO2 Main** display, press **SPO2 MAIN** soft key.

6. To return to Main Display, press **MAIN SCREEN** soft key.

Navigate PCA/SpO2 Trend Data

To access and view shared trend data when a PCA Module is present, perform the following steps:

- To access option to view trend data, press **OPTIONS** key while in **SPO2 Main** display.
- To view **Trend Data**, press **PCA/SpO2 Trend data** soft key.
 - Tabular information is not updated while **Trend Data** view is displayed. Tabular data is updated, using new trend data stored in SpO₂ Module, after leaving **Trend Data** view. To view latest data, return to **Trend Data** view.
 -  is displayed if an alarm limit is reached.
 - If no **SPO2** or **PULSE** rate values are available for time period displayed, dashes (---) display.

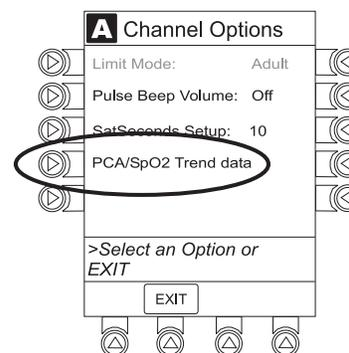

Monitoring Mode (Continued)

Navigate PCA/SpO₂ Trend Data (Continued)

- See "Navigate Trend Data" procedure for instructions on how to:
 - Navigate from page to page.
 - Change **TIME** increments.
 - Return to **SPO2 Main** display.
 - Return to Main Display.

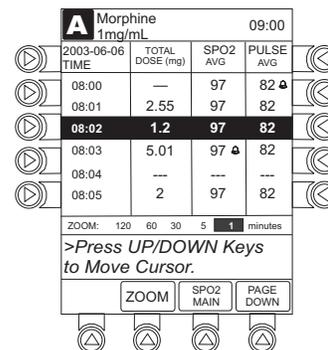

Presilence Alarm

- To presilence alarm, press **SILENCE** key.
All monitoring alarms are silenced for 120 seconds. Subsequent infusion alarms are not silenced.
- To cancel presilence alarm and return to alarmable mode:
 - Press **CHANNEL SELECT** key.
 - Press **CANCEL SILENCE** soft key.

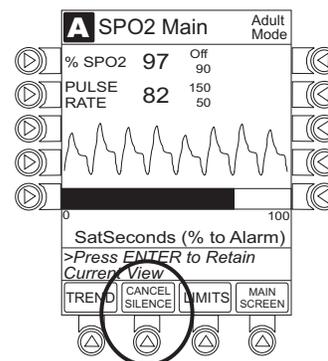
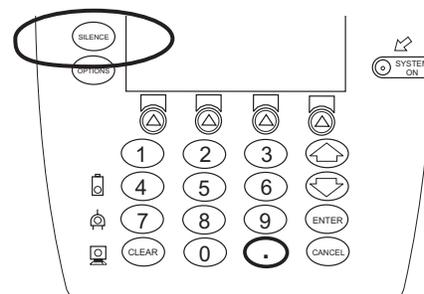

Channel Options

Change Limit Mode

The following procedure can be performed only when the Guardrails® Suite MX is not enabled (profile option not being used for programming).

1. Press **Limit Mode** soft key.

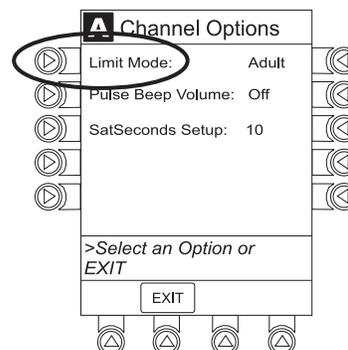

2. To change **Limit Mode Setup**, press applicable soft key.

OR

To leave **Limit Mode Setup** unchanged and return to **SPO2 Main** display, press **EXIT** soft key.

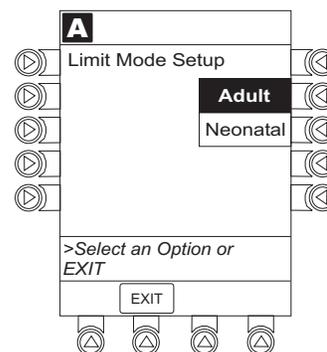

Change Pulse Beep Volume

1. Press **Pulse Beep Volume** soft key.

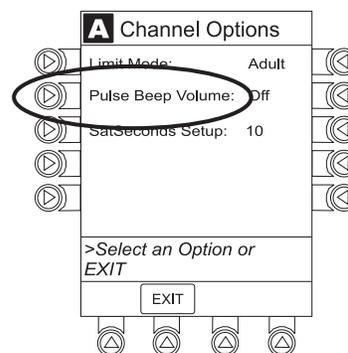

Channel Options (Continued)

Change Pulse Beep Volume (Continued)

2. To test or change:
 - a. To test volume level (when not attached to patient), press **Test** soft key.

Pulse beep must be on to test volume level. To turn pulse beep on, press **Louder** soft key and adjust as needed.
 - b. To increase volume, press **Louder** soft key until desired volume level is attained (1, 2 or 3).
 - c. To decrease volume, press **Softer** soft key until desired volume level is attained.
 - d. To turn off pulse beep, press **Off** soft key.
3. To return to **SPO2 Main** display, press **CONFIRM** soft key.

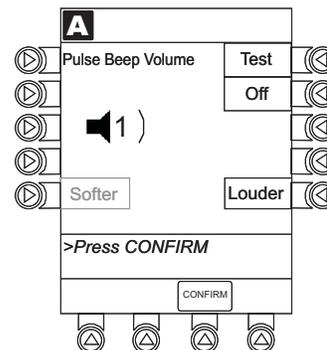

Change SatSeconds™ Limit →

NELLCOR
(8210)

1. Press **SatSeconds Setup** soft key.
2. To change SatSeconds™, press applicable soft key. Selectable **Increase** and **Decrease** options are **10**, **25**, **50** and **100** seconds.
3. To return **SPO2 Main** display, press **CONFIRM** soft key.

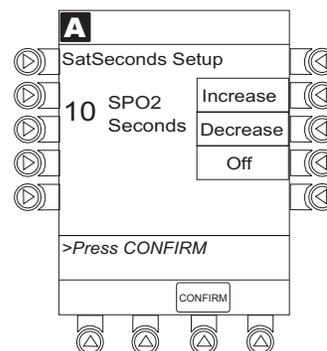
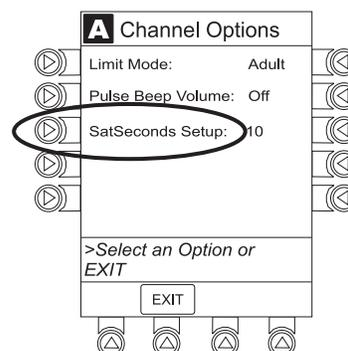

Channel Options (Continued)

Change Saturation Averaging Time →

Masimo SET.
(8220)

1. Press **Saturation Averaging Time** soft key.

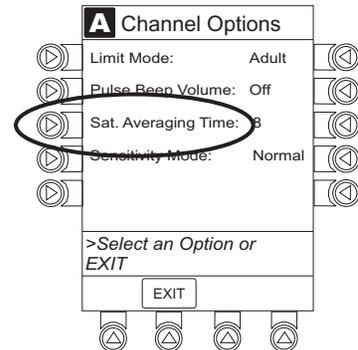

2. To change **Saturation Averaging Time**, press applicable soft key. Selectable options are **2, 4, 8, 10, 12, 14** and **16** seconds.

FAST SAT is enabled when **2** or **4** seconds is selected.

3. To return **SPO2 Main** display, press **CONFIRM** soft key.

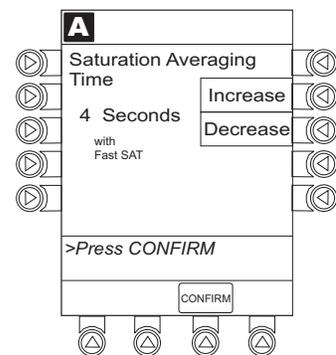

Change Sensitivity Mode →

Masimo SET.
(8220)

1. Press **Sensitivity Mode** soft key.

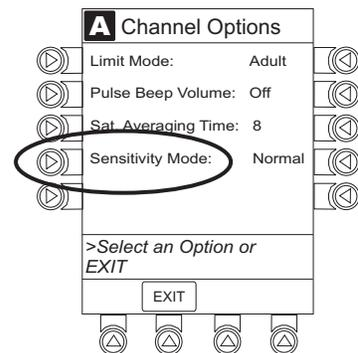

Channel Options (Continued)

Change Sensitivity Mode (Continued) →

Masimo SET
(8220)

2. To change **Sensitivity Mode**, press applicable soft key. ①
- **Normal**: Normal patient monitoring.
 - **Maximum**: Improved low perfusion performance.

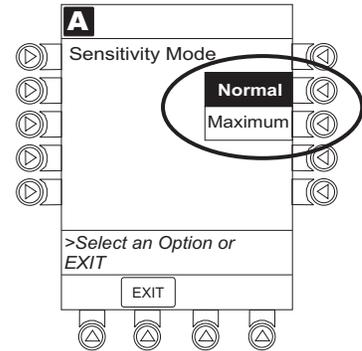

NOTE:

- ① The sensitivity mode is displayed on the **SPO2 Main** display only when **Maximum** is selected.

THIS PAGE
INTENTIONALLY
LEFT BLANK

System Start-Up/Setup

See the PC Unit section of this DFU, "General Setup and Operation," for various system start-up and setup procedures.

THIS PAGE
INTENTIONALLY
LEFT BLANK

Warnings and Cautions

General

WARNINGS

- The SpO₂ Module is **not to be used as an apnea monitor**.
- **Pulse oximetry readings and pulse signal** can be affected by certain ambient conditions, sensor application errors and certain patient conditions.
- The SpO₂ Module is intended only as an **adjunct in patient assessment**. It must be used in conjunction with clinical signs and symptoms.
- The SpO₂ Module should be considered an **early warning device**. As a trend towards patient deoxygenation is indicated, blood samples should be analyzed by a laboratory CO-Oximeter to completely understand the patient's condition.
- **Interfering Substances:** Carboxyhemoglobin and methemoglobin can erroneously increase readings. The level of increase is approximately equal to the amount of carboxyhemoglobin present. Dyes, or any substance containing dyes, that change usual arterial pigmentation can cause erroneous readings.
- The SpO₂ Module is **not rated for defibrillation use**. Disconnect the sensor from the patient or patient cable from the module prior to defibrillation.
- **Do not lift** the SpO₂ Module by the cable because it could disconnect from the instrument, causing it to drop on the patient. Do not place the SpO₂ Module in any position that could cause it to fall onto the patient.
- **Respond immediately to system alarms;** patient monitoring can cease under certain alarm conditions.

Warnings and Cautions (Continued)

Sensors and Cables

WARNINGS

- **Inspect the SpO₂ sensor site regularly** to ensure correct sensor positioning, application and site integrity. Tissue damage could occur over prolonged time periods, depending on the patient profile (such as neonates) and method of application. Refer to the sensor instructions for additional information.
- Do not use a sensor, cable or connector that **appears damaged**. Do not use a sensor with **exposed optical components**.
- The sensor **disconnect error message** and associated alarm indicate the sensor is either disconnected or the wiring is faulty. Check the sensor connection and, if necessary, replace the sensor.
- **Model 8210:**
 - **Use only** approved Oximax[®] sensors, and DOC-10 and OC-3 pulse oximetry cables.

Model 8220:

Use only approved Masimo[®] sensors and patient cables.

Use of sensors, transducers, cables and accessories other than those specified can cause improper SpO₂ Module performance resulting in inaccurate readings, increased emission and/or decreased immunity, and degraded electromagnetic compatibility performance of the SpO₂ Module. For a list of compatible sensors and cables, refer to the Sensor and Cable Compatibility Card (provided separately).

- **Carefully route patient cabling** to reduce the possibility of patient entanglement or strangulation.
- Before use, **read the sensor directions for use**, including all warnings, cautions and instructions.

CAUTION

Do not immerse or dampen the sensor or cable. Clean per manufacturer's instructions.

Cables and Sensors

Nellcor® Patient Cables and OxiMAX® Sensors



The Nellcor® DOC-10 and OC-3 patient cables interface the SpO₂ Module with the patient sensors.

When selecting a sensor, consider the patient's weight, the adequacy of perfusion, the available sensor sites and the duration of monitoring. Use only OxiMAX® sensors. Select an appropriate sensor, apply it as directed, and observe all warnings and cautions presented in the directions for use accompanying the sensor.

For a list of compatible sensors and cables, refer to the Sensor and Cable Compatibility Card (provided separately).

Masimo® Patient Cables and Sensors



Reusable patient cables of various lengths are available. All cables that display the Masimo® SET® logo are designed to work with an SpO₂ Module displaying the Masimo® SET® logo.

When selecting a sensor, consider the patient's weight, the adequacy of perfusion, the available sensor sites and the duration of monitoring. Use only Masimo® SET® sensors. Select an appropriate sensor, apply it as directed, and observe all warnings and cautions presented in the directions for use accompanying the sensor.

For a list of compatible sensors and cables, refer to the Sensor and Cable Compatibility Card (provided separately).

Features and Displays

Features and Definitions

See the PC Unit section of this DFU for system features and definitions.

Models 8210  NELLCOR and 8220  MASIMO SET.	
Feature	Definition
% SpO₂ Alarm Limits	Upper and lower saturation limits for %SpO ₂ alarm can be adjusted by clinician.
% SpO₂ Display	Functional arterial hemoglobin oxygen saturation is displayed in units of percentage SpO ₂ .
Limit Mode	Configurable mode that can be set to display either adult or neonatal monitoring mode. (See "Configurable Settings" for additional configurable features.)
Pleth Waveform	Plethysmographic (pleth) waveform is a graphic representation of changes in extremity blood volume during cardiac cycle events. Displayed waveform is a simulated signal (non-normalized).
Pulse Beat Volume	Sound of each pulse beep can be configured to be off or to a volume level of 1, 2, or 3.
Pulse Rate	Displayed in beats per minute (bpm).
Pulse Rate Alarm Limits	Upper and lower pulse rate alarm limits can be adjusted by clinician.
Trend Data	Tabular display of %SpO ₂ and pulse rate. Display shows average high and low values, and alarm conditions for time period displayed. Up to 24 hours of data is stored.

Features and Displays (Continued)

Features and Definitions (Continued)

Model 8210  NELLCOR	
Feature	Definition
SatSeconds™	<p>SatSeconds™ limits controls time %SpO₂ level can fall outside alarm limits before an audible alarm sounds. Method of calculation is as follows:</p> <p style="padding-left: 40px;">Number of percentage points %SpO₂ falls outside of alarm limit is multiplied by number of seconds %SpO₂ level remains outside that limit.</p> <p style="padding-left: 40px;">Points x Seconds = SatSeconds™</p> <p style="padding-left: 40px;">Points = %SpO₂ percentage points outside of limit</p> <p style="padding-left: 40px;">Seconds = number of seconds %SpO₂ remains at that point outside of limit</p> <p>Saturation levels might fluctuate rather than remain steady for a period of several seconds. %SpO₂ levels might fluctuate above and below alarm limit, reentering nonalarm range several times. During such fluctuations, SpO₂ Module integrates number of %SpO₂ points, both positive and negative, until either SatSeconds™ limit (SatSeconds™ time setting) is reached or %SpO₂ level returns to within a normal range and remains there.</p> <p>SatSeconds™ "Safety Net" is for patients with saturation levels having frequent excursions below limit but not staying below limit long enough for SatSeconds™ time setting to be reached. When three or more limit violations occur within 60 seconds, an alarm sounds, even if SatSeconds™ time setting has not been reached.</p>
SatSeconds™ alarm management	<p>With SatSeconds™ alarm management technology, upper and lower alarm limits are set in the same way as with traditional alarm management. A SatSeconds™ limit can be set to allow monitoring of %SpO₂ below selected low alarm limit for a period of time before an audible alarm sounds.</p>

Features and Displays (Continued)

Features and Definitions (Continued)

Model 8220 	
Feature	Definition
Fast SAT	When Fast SAT is enabled and there is one data point that is significantly different from a previous data point, averaging is disregarded and most recent data point is displayed. For example, if readings were 97%, 96%, 95%, and 85%, displayed saturation level would be 85%.
PI	Perfusion Index (PI) is a scaled numeric value derived from magnitude of pulsations displayed on plethysmographic (pleth) waveform. It is calculated as a percentage of pulsatile signal to nonpulsatile signal. PI is used to find best perfused site for sensor placement (larger the PI, stronger the perfusion). Operating range is 0.02 to 20. Desired number is greater than 1 or as large as possible.
Saturation Averaging Time	Averaging time can be set to 2, 4, 8, 10, 12, 14, or 16 seconds.
Sensitivity Mode	Sensitivity mode, normal or maximum, of current monitoring configuration is displayed in options mode. Normal setting is used for normal patient monitoring purposes. Maximum setting is used for improved low perfusion performance.
SET[®] Technology	Signal Extraction Technology [®] (SET [®]) uses adaptive filters to separate arterial signal from nonarterial noise. SET [®] provides for accurate readings under extreme conditions (such as low perfusion and motion).
Signal I.Q.[™] Feature	A visual indication of pulsation at sensor site. Vertical bar height indicates quality of measured signal. Signal I.Q. [™] feature is related to proper sensor application, adequate arterial signal, and intensity of motion. Use Signal I.Q. [™] feature to verify optimal sensor placement.

Features and Displays (Continued)

Operating Features, Controls, Indicators

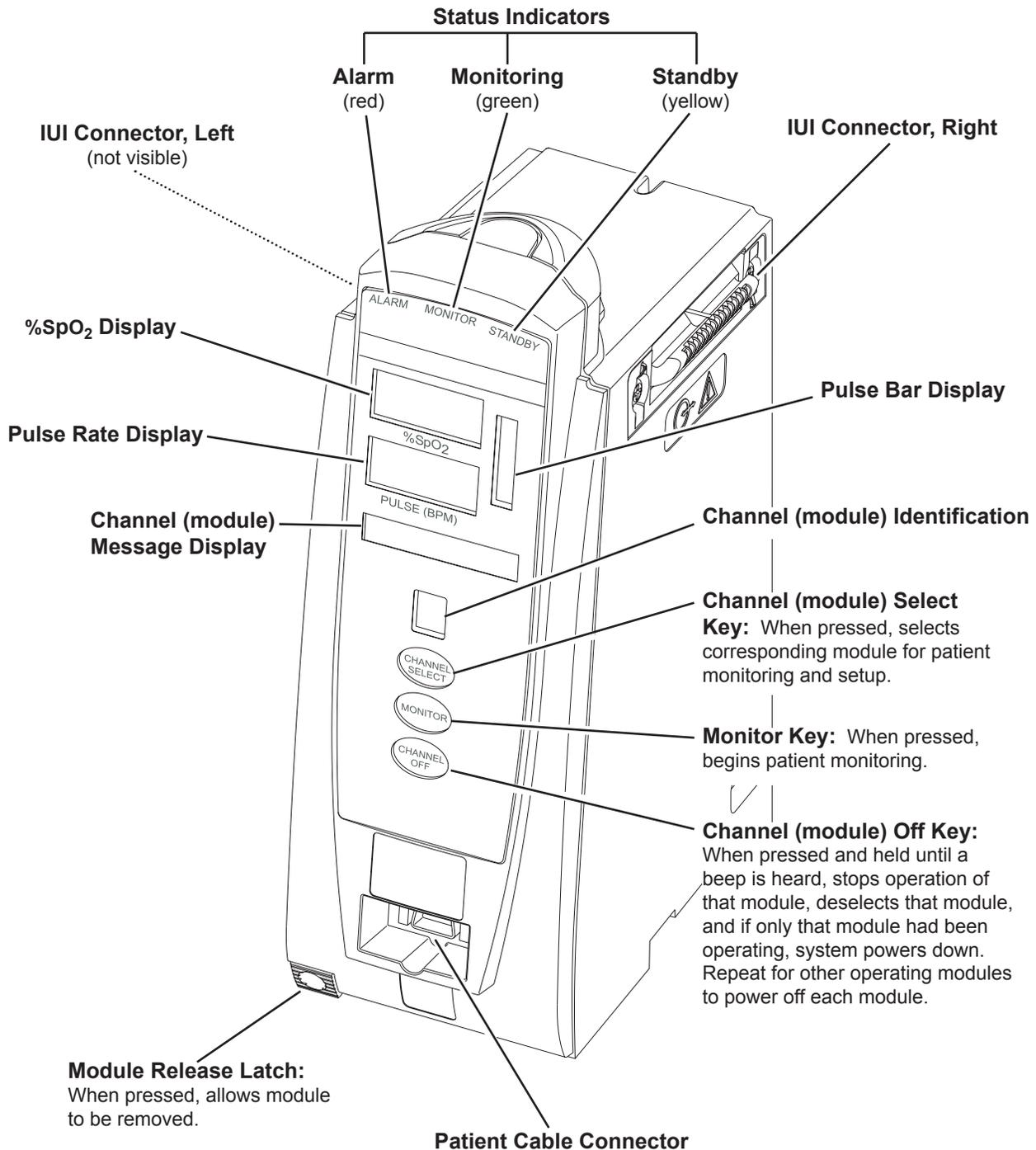

Features and Displays (Continued)

Displays

The displays illustrated throughout this document are for illustration purposes only. The display content varies, depending on configuration settings, hospital-defined Data Set uploaded using the Guardrails® Suite MX, programmed parameters, and many other variables.

Main Display

See the PC Unit section of this DFU.

SPO2 Main Display

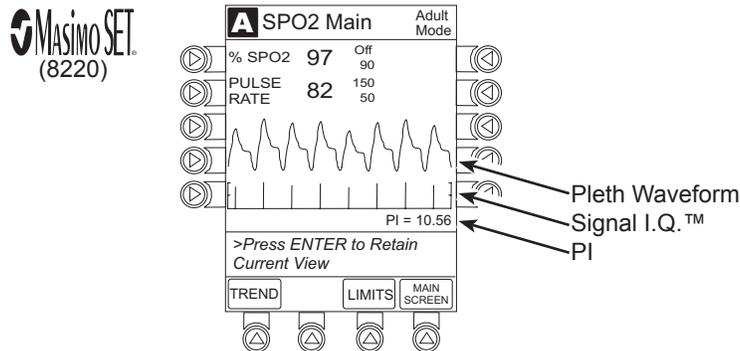
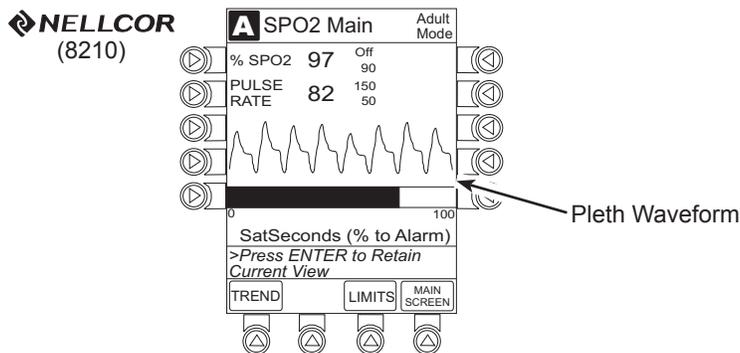

Configurable Settings

See the PC Unit section of this DFU for system configurable settings.

If the configuration settings need to be changed from the **Factory default** settings, refer to the applicable Technical Service Manual or contact CareFusion Technical Support, for technical, troubleshooting, and preventive maintenance information.

With the Profiles feature enabled, the settings are configured independently for each profile. A hospital-defined, best-practice Data Set must be uploaded to enable the Profiles feature. Date and Time is a system setting and is the same in all profiles.

Models 8210  <i>NELLCOR</i> and 8220  <i>MASIMO SET</i>		
Feature	Default Setting	Options
Limit Mode	Adult	Adult, Neonatal
Pulse Beep Volume	1	1, 2, 3, Off
Pulse Rate Alarm Limit, High	Adult Mode: 120 bpm Neonatal Mode: 200 bpm	31 - 240 bpm
Pulse Rate Alarm Limit, Low	Adult Mode: 50 bpm Neonatal Mode: 100 bpm	30 - 239 bpm
SpO ₂ Alarm Limit, High	Adult: Off Neonatal: 95%	21 - 100%, Off
SpO ₂ Alarm Limit, Low	Adult: 90% Neonatal: 80%	20 - 99%

Model 8210  <i>NELLCOR</i>		
Feature	Default Setting	Options
SatSeconds	Off	10, 25, 50, 100 seconds; Off

Configurable Settings (Continued)

Model 8220 MASIMO SET.		
Feature	Default Setting	Options
Saturation Averaging Time (display update period)	8 seconds	2, 4, 8, 10, 12, 14, 16 seconds
Sensitivity Mode	Normal	Normal, Maximum

Specifications and Symbols

Specifications

Models 8210 NELLCOR and 8220 MASIMO SET.

Alarms: Audible and visual alarms for high and low saturation and pulse rate, sensor condition, system failure, and low battery conditions

Alarm Limits:

	Low	High
Pulse Rate:	30 - 239 bpm	31 - 240 bpm
SpO ₂	20 - 99%	21 - 100%

Dimensions:

3.3" W x 8.9" H x 5.5" D
(8.4 cm W x 22.6 cm H x 14 cm D)

Environmental Conditions:

	Operating	Storage/Transport
Atmospheric Pressure	525 - 4560 mmHg (700 - 6080 hPa)	375 - 760 mmHg (500 - 1013 hPa)
Relative Humidity	20 - 90% Noncondensing	5 - 85% Noncondensing
Temperature Range	41 - 104°F (5 - 40°C)	-4 - 140°F (-20 - 60°C)

Fluid Ingress Protection: IPX1, Drip Proof

Mode of Operation: Continuous

Shock Protection: Type BF

Weight: 2 lbs (0.91 kg)

Specifications and Symbols (Continued)

Specifications (Continued)

Model 8210 NELLCOR

Accuracy Tolerance:

	Low Perfusion ^①	Adult ^②	Neonate ^②
Pulse Rate	20 - 250 bpm ±3 digits	20 - 250 bpm ±3 digits	20 - 250 bpm ±3 digits
Functional Saturation	70 - 100% ±2 digits	70 - 100% ±2 digits	70 - 100% ±3 digits

Display Update Period: 2.25 seconds

Measurement Range:
 Perfusion: 0.03 - 20%
 Pulse Rate: 20 - 250 bpm
 SpO₂: 1 - 100%

Pulse Amplitude Display: Visual indicators for pulse signals represent proportional pulse amplitude strength.

Sensor: Emitted light wavelength range is within 500 - 1000 nm. Output power does not exceed 15 mw.

Model 8220 MASIMO SET

Accuracy and Motion Tolerance:

	Low Perfusion ^③	Motion ^{④ ⑤}	No Motion ^⑥	Resolution
Pulse Rate	25 - 240 bpm Adults, Pediatrics, Neonates: ±3 digits	25 - 240 bpm Adults, Pediatrics, Neonates: ±5 digits	25 - 240 bpm Adults, Pediatrics, Neonates: ±3 digits	1 bpm
Saturation	70 - 100% Adults, Pediatrics: ±2 digits; Neonates: ±3 digits	70 - 100% Adults, Pediatrics, Neonates: ±3 digits	70 - 100% Adults, Pediatrics: ±2 digits; Neonates: ±3 digits	1% SpO ₂

Display Update Period: Approximately 1 second.

Measurement Range:
 Perfusion: 0.02 - 20%
 Pulse Rate: 25 - 240 bpm
 SpO₂: 1 - 100%

Pulse Amplitude Display: Proportional to height of I.Q. signal.

Sensor: Emitted light wavelength range is within 500 - 1000 nm. Output power does not exceed 1 mw.

Specifications and Symbols (Continued)

Specifications (Continued)

NOTES:

- ① Specification applies to monitor performance.
- ② Adult specifications are shown for OxiMAX® MAX-A and MAX-N sensors. Neonate specifications are shown for OxiMAX® MAX-N sensors. Saturation accuracy varies by sensor type.
- ③ Masimo® Board performance has been validated for low perfusion accuracy in bench-top testing against a BIO-TEK simulator and a Masimo® simulator.
- ④ Masimo® Board performance has been validated for motion accuracy in human blood studies on healthy adult volunteers in induced hypoxia studies, while performing rubbing and tapping motions at 2 - 4 Hz at an amplitude of 1 - 2 cm and a nonrepetitive range of 70 - 100% SpO₂ against a laboratory co-oximeter and ECG monitor. This variation equals plus or minus one standard deviation. Plus or minus one standard deviation encompasses 68% of the population.
- ⑤ Masimo® Board performance with Masimo® LNOP® Neo and Neo Pt sensors has been validated for neonatal motion accuracy in human blood studies on neonates, while moving the neonate's foot at 2 - 4 Hz at an amplitude of 1 - 2 cm against a laboratory co-oximeter and ECG monitor. This variation equals plus or minus one standard deviation. Plus or minus one standard deviation encompasses 68% of the population.
- ⑥ Masimo® Board performance has been validated for no-motion accuracy in human blood studies on healthy adult volunteers in induced hypoxia studies, in the range of 70 - 100% SpO₂ against a laboratory co-oximeter and ECG monitor. This variation equals plus or minus one standard deviation. Plus or minus one standard deviation encompasses 68% of the population.

Specifications and Symbols (Continued)

Symbols

See the PC Unit section of this DFU for system symbols.

Symbol	Meaning
	Silenced alarm. Note: When displayed, the dashed lines through the symbol might appear as solid lines due to the small display size.
	Is displayed in Trend Data screen to identify an exceeded alarm limit.
	Type BF equipment.

Measurement Accuracy

If the accuracy of any measurement does not seem reasonable, first check the patient's vital signs by alternate means and then check the SpO₂ Module to ensure it is functioning properly.

An inaccurate measurement can be caused by:

- Incorrect sensor application or use.
- Significant levels of dysfunctional hemoglobins (such as carboxyhemoglobin or methemoglobin).
- Intravascular dyes (such as indocyanine green or methylene blue).
- Exposure to excessive illumination; such as, a surgical lamp (especially one with a xenon light source), bilirubin lamp, fluorescent light, infrared heating lamp or direct sunlight. ^①
- Prolonged and/or excessive patient movement.
- Venous pulsations.
- Sensor placed on an extremity with a blood pressure cuff, arterial catheter, intravascular line or other causes of insufficient perfusion.
- Nail irregularity, such as nail polish or fungus. Remove nail polish and/or move sensor to an unaffected site.

Measurement Accuracy (Continued)

- Placement is too close to electrosurgery equipment.
- Defibrillation.

The loss of a pulse signal can occur in any of the following situations:

- Sensor is too tight.
- Exposure to excessive illumination; such as, a surgical lamp (especially one with a xenon light source), bilirubin lamp, fluorescent light, infrared heating lamp or direct sunlight.
- Sensor placed on an extremity with a blood pressure cuff, arterial catheter, intravascular line or other causes of insufficient perfusion.
- Patient has hypotension, severe vasoconstriction, severe anemia or hypothermia, is in cardiac arrest or is in shock.
- There is an arterial occlusion proximal to sensor.
- Placement is too close to electrosurgery equipment.

NOTE:

- ① Exposure to excessive illumination can be corrected by covering the sensor with a dark or opaque material.

Troubleshooting and Maintenance

General

Troubleshooting and maintenance are intended to be performed only by qualified personnel, using the SpO₂ Module Technical Service Manual and the System Maintenance software. The Service Manual and System Maintenance software are available from CareFusion. The Service Manual includes routine service schedules, interconnect diagrams, component parts lists and descriptions, test procedures, and other technical information to assist qualified service personnel in repair and maintenance of the instrument's repairable components. The System Maintenance software is used to perform a new instrument check-in and preventive maintenance tests.

Alarms and Messages

See the PC Unit section of this DFU for the following system references:

Alarms, Errors, Messages
Audio Characteristics
Definitions
Radio Frequency Note

Definition

Alarm Silence Alarms can be silenced for up to 120 seconds by pressing **SILENCE** key. Alarm indicators remain on and alarm silence symbol is displayed. Silence period can be ended by pressing **CANCEL SILENCE** soft key.

Alarms

Models 8210  NELLCOR and 8220 		
Alarm	Meaning	Response
Bad Sensor	Broken, unknown, or nonsystem sensor or patient cable attached.	Check sensor and patient cable. Confirm correct sensor and patient cable are chosen.
Check Sensor - Electrical or Optical Interference	External interference on sensor.	Check sensor. Identify source of external interference if other than sensor.

Alarms and Messages (Continued)

Alarms (Continued)

Models 8210  NELLCOR and 8220 		
Alarm	Meaning	Response
High Pulse Rate Alarm	High pulse rate alarm limit has been exceeded.	Assess patient's condition. Confirm correct alarm limit values are selected.
High SpO ₂ Alarm	High SpO ₂ alarm limit has been exceeded.	Assess patient's condition. Confirm correct alarm limit values are selected.
Low Pulse Rate Alarm	Low pulse rate alarm limit has been exceeded.	Assess patient's condition. Confirm correct alarm limit values are selected.
Low SpO ₂ Alarm	Low SpO ₂ alarm limit has been exceeded.	Assess patient's condition. Confirm correct alarm limit values are selected.
No Sensor	Sensor not properly attached to patient cable or patient cable not properly attached to SpO ₂ Module.	Attach sensor to patient cable or attach patient cable to SpO ₂ Module.
No Signal	Failure to find a patient signal after 30 seconds of searching.	Check sensor. Confirm correct sensor placement.
Remove Module (Max=1)	More than one SpO ₂ Module attached.	Remove additional SpO ₂ Module.
Sensor Off	Sensor not properly attached to patient.	Reattach sensor to patient.

Model 8210  NELLCOR		
Alarm	Meaning	Response
Check Sensor - High Pulse Amplitude	Artifact interfering with pulse reading.	Check sensor - relocate sensor to a site with less artifact interference.
Check Sensor - Excessive Ambient Light	Light interference on sensor.	Check sensor. Remove or reduce lighting. Cover or reposition sensor.
Check Sensor - Motion Interference	Patient's motion has inhibited monitoring.	Check sensor. Move sensor to a site with less motion.

Alarms and Messages (Continued)

Alarms (Continued)

Model 8210  NELLCOR		
Alarm	Meaning	Response
Check Sensor - No signal	Sensor not properly attached to patient cable or patient cable not properly attached to SpO ₂ Module.	Attach sensor to patient cable or attach patient cable to SpO ₂ Module.
Check Sensor - Weak Pulse	Patient's low perfusion has inhibited monitoring.	Check sensor. Move sensor to a better perfused site.
Check Sensor - Weak Signal	Low quality of signal being measured.	Check sensor. Confirm correct sensor placement. Move sensor to a better perfused site.

Model 8220  MASIMO SET		
Alarm	Meaning	Response
Check Sensor - Light	Light interference on sensor.	Check sensor. Remove or reduce lighting. Cover or reposition sensor.
Check Sensor - Low Perfusion	Patient's low perfusion has inhibited monitoring.	Check sensor. Move sensor to a better perfused site.
Check Sensor - Low Signal I.Q.	Low signal quality being measured.	Check sensor. Confirm correct sensor placement. Move sensor to a better perfused site.

Messages

Model 8210  NELLCOR		
Message	Meaning	Response
Check Sensor - Electrical or Optical Interference	External interference on sensor.	Check sensor. Identify source of external interference if other than sensor.
Check Sensor - High Pulse Amplitude	Artifact interfering with pulse reading.	Check sensor. Relocate sensor to a site with less artifact interference.

Alarms and Messages (Continued)

Messages (Continued)

Model 8210  NELLCOR		
Message	Meaning	Response
Check Sensor - Excessive Ambient Light	Light interference on sensor.	Check sensor. Remove or reduce lighting. Cover or reposition sensor.
Check Sensor - Motion Interference	Patient's motion has inhibited monitoring.	Check sensor. Move sensor to a site with less motion.
Check Sensor - Weak Pulse	Patient's low perfusion has inhibited monitoring.	Check sensor. Move sensor to a better perfused site.
Check Sensor - Weak Signal	Low quality of signal being measured.	Check sensor. Confirm correct sensor placement. Move sensor to a better perfused site.

Model 8220  MASIMO SET		
Message	Meaning	Response
Check Sensor - Low Perfusion	Patient's low perfusion has inhibited monitoring.	Check sensor. Move sensor to a better perfused site.
Check Sensor - Low Signal I.Q.	Low signal quality being measured.	Check sensor. Confirm correct sensor placement. Move sensor to a better perfused site.

Inspection Requirements

To ensure that the Alaris® System remains in good operating condition, both regular and preventive maintenance inspections are required. Refer to the System Maintenance software for detailed instructions.

REGULAR INSPECTIONS

PROCEDURE	FREQUENCY
INSPECT FOR DAMAGE: <ul style="list-style-type: none">• Exterior Surfaces• IUI Connector• Keypad	<ul style="list-style-type: none">• Each usage• Each usage• Each usage
CLEANING	As required
START-UP	Each usage

WARNING

Failure to perform these inspections can result in improper instrument operation.

CAUTION

Preventive maintenance inspections should only be performed by qualified service personnel.

Alaris® EtCO₂ Module Model 8300

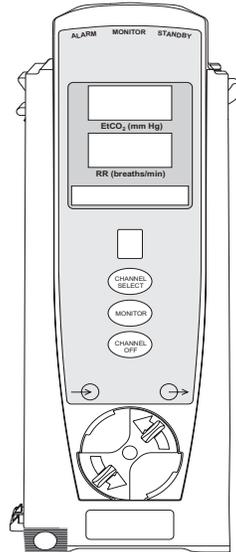

Getting Started

Introduction	5-1
Connect Microstream® Disposable	5-2
Attach Gas Scavenging System	5-3

Programming

Monitoring Mode	5-5
Set Alarm Limits	5-6
Navigate Trend Data	5-7
Navigate PCA/EtCO ₂ Trend Data	5-8
Presilence Alarm	5-9
Channel Options	5-9
Change Limit Mode	5-9
Change Waveform Height	5-10
Change Waveform Time Scale	5-11

General Setup and Operation

System Start-Up/Setup	5-13
-----------------------------	------

General Information

Warnings and Cautions	5-15
General	5-15
Microstream® Disposable	5-15
Microstream® Disposable	5-16
Features and Displays	5-17
Features and Definitions	5-17
Operating Features, Controls, Indicators	5-18
Displays	5-19
Configurable Settings	5-19
Specifications and Symbols	5-20
Specifications	5-20
Symbols	5-22
Measurement Accuracy	5-23
Waveform Analysis	5-23
Principle of Operation	5-25

Troubleshooting and Maintenance

General	5-27
Alarms and Messages	5-27
Definitions	5-27
Audio Characteristics	5-28
Alarms	5-28
Messages	5-29
Inspection Requirements	5-30

THIS PAGE
INTENTIONALLY
LEFT BLANK

Introduction

This section of the DFU provides EtCO₂ Module (Model 8300) instructions and information. It is used in conjunction with:

- EtCO₂ Module Technical Service Manual
- Microstream® Disposable Compatibility Card
- Oridion's Microstream® disposable instructions
- PC Unit section of this DFU
- System Maintenance software (and its instructions) for Alaris® System check-in, maintenance, and wireless configuration

The EtCO₂ Module is a capnograph indicated for continuous, noninvasive monitoring of end tidal carbon dioxide (EtCO₂), fractional inspired carbon dioxide (FiCO₂) and respiratory rate (RR). The EtCO₂ Module and disposables are indicated for use with intubated and nonintubated adult, pediatric and neonatal patients. It is not intended for direct connection to ventilator or breathing systems. Only one EtCO₂ Module can be connected to the Alaris® System.

The EtCO₂ Module is used with Oridion's patented Microstream® Disposables/circuits for sidestream capnography.

Microstream® Disposable: See "General Information" for "Microstream® Disposable" Information.

Alarms and Messages: See "Troubleshooting and Maintenance" for module-specific alarms and messages.

Contraindications: None known.

Electromagnetic Environment: See "Appendix" section of this DFU ("Regulations and Standards," "Compliance").

WARNING

Read all instructions, for both the EtCO₂ Module and PC Unit, before using the Alaris® System.

CAUTION

Rx Only

Connect Microstream® Disposable

1. Open gas inlet/outlet door by turning door counterclockwise until gas inlet is clearly visible. Hold in open position.

Gas inlet is located on lower left corner of instrument and is marked with a gas inlet symbol (→).

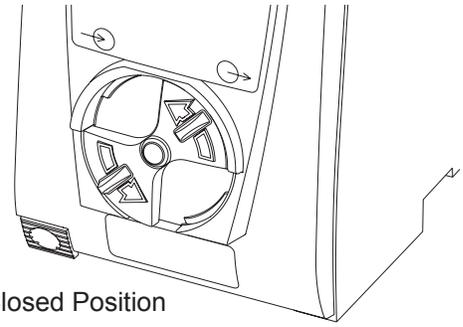

Closed Position

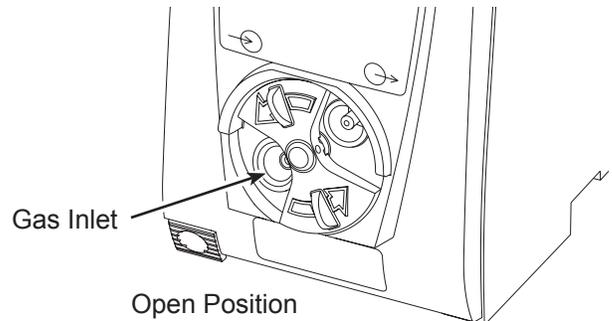

Open Position

2. Connect Microstream® Disposable:
 - a. Press brightly colored end of disposable into gas inlet.
 - b. Turn it clockwise until tightly secured to EtCO₂ Module.

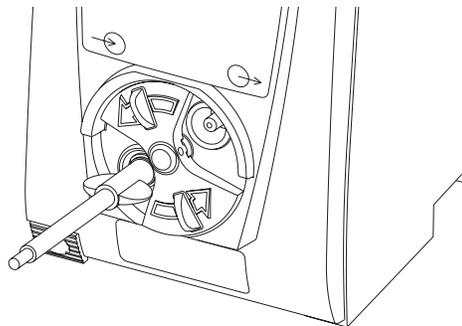

WARNING

Use only Microstream® Disposables. Use of a disposable other than those specified can cause improper EtCO₂ Module performance, resulting in inaccurate readings. For a list of compatible disposables, refer to the Microstream® Disposable Compatibility Card (provided separately).

3. Release door.
4. Connect Microstream® Disposable to patient. Connection site and manner are dependent on patient intubation status and type of Microstream® Disposable being used (refer to disposable's directions for use).

Attach Gas Scavenging System

In the presence of high oxygen or anesthesia concentrations, it might be necessary to connect a gas scavenging system to the EtCO₂ Module.

1. Open gas inlet/outlet door by turning door counterclockwise until gas outlet is clearly visible. Hold in open position.

Gas outlet is located on lower right corner of instrument and is marked with a gas outlet symbol (⊙→).

2. Secure gas scavenger system tubing to EtCO₂ Module by firmly pushing tubing into fitting on gas outlet.

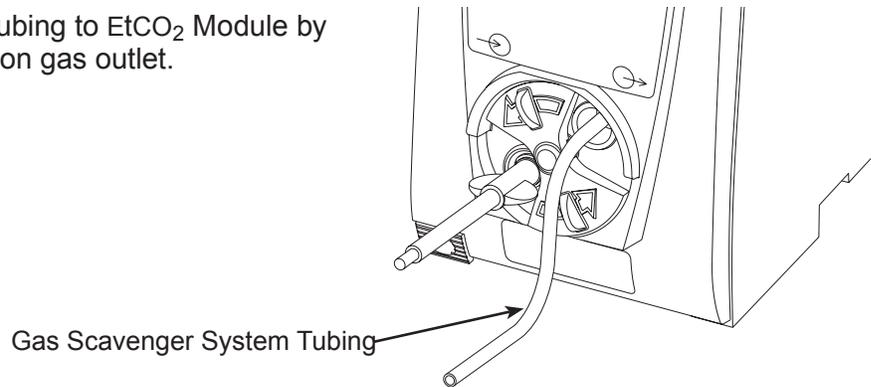

3. Release door.

THIS PAGE
INTENTIONALLY
LEFT BLANK

Display references throughout this procedure are for illustration purposes only.

See "General Information," "Features and Displays" and PC Unit section of this DFU for information about:

- Displays
- Operating Features, Controls, Indicators

Monitoring Mode

1. Perform following steps (see PC Unit section of this DFU, "General Setup and Operation," "Start-Up"):
 - a. Power on system.
 - b. Choose **Yes** or **No to New Patient?**
 - c. Confirm current profile or select a new profile.
 - d. Enter patient identifier, if required.
2. Connect Microstream® Disposable (see "Getting Started").
3. Press **CHANNEL SELECT** key.

SENSOR WARMING and then **SEARCHING** appear in Channel Message display until EtCO₂ and respiratory rate readings stabilize (up to 60 seconds).

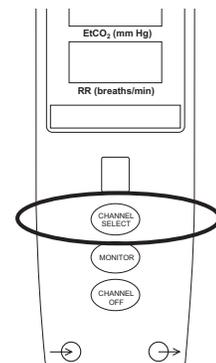

4. Alarm limits:
 - To change settings, see "Set Alarm Limits" procedure.

Monitoring Mode (Continued)

- To accept settings and begin monitoring, press **ENTER** key.

ETCO2 Main screen displays following information: ①

- Capnography waveform (scale adjustable).
- EtCO₂ value, as well as minimum and maximum EtCO₂ alarm limits.
- Limit Mode (Adult or Neonatal).
- Respiratory rate (RR, breaths/min), as well as minimum and maximum RR alarm limits.

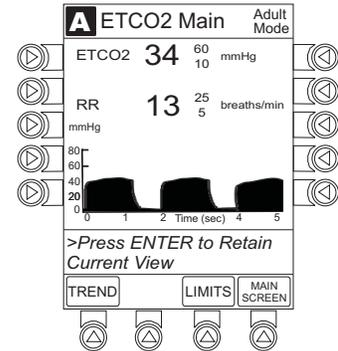

NOTE:

- ① PC Unit display response time is approximately ½ second longer than the EtCO₂ Module response time.

Set Alarm Limits

- Press **LIMITS** soft key.
- To change a limit setting, press soft key next to applicable parameter.
- Enter a numeric value for selected alarm limit.
- To move to next limit, press **ENTER** key.
- To confirm alarm settings and return to **ETCO2 Main** display, press **CONFIRM** soft key.

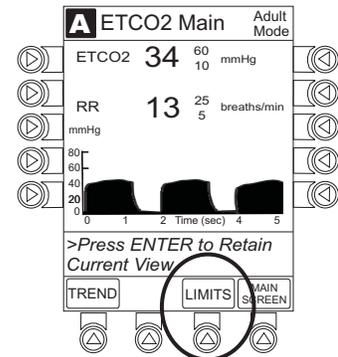

- To return to Main Display, press **MAIN SCREEN** soft key.

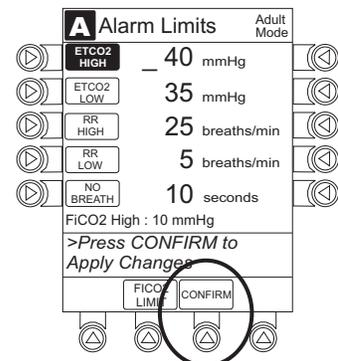

Monitoring Mode (Continued)

Navigate Trend Data

- To view Trend Data, press **TREND** soft key.

Following information is displayed:

- **TIME** period for data review.
- Average **ETCO2** with high and low values.
- Average respiratory rate (**RR**) with high and low values.
- Alarm icon (⚠) with **Fi** in **TIME** column to indicate high FiCO₂ alarm limit has been exceeded.
- Alarm icon (⚠) to indicate an alarm limit has been exceeded.
- Alarm icon (⚠) in **RR** column to indicate a no breath (⚡) alarm limit has been triggered.
- Dashes (---), if no EtCO₂ or respiratory rate values are available for time period displayed.

Tabular information is not updated while **Trend Data** view is displayed. Tabular data is updated, using new trend data stored in EtCO₂ Module, after leaving Trend Data view. To view latest data, return to **Trend Data** view.

- To navigate from page to page, press **PAGE UP** and **PAGE DOWN** soft keys.
- To scroll data one row at a time, press \uparrow or \downarrow key.

2001-07-06		ETCO2		RR		09:00	
TIME	AVG	MAX	MIN	AVG	MAX	MIN	
22:58 Fi ⚠	40	47	38	13	26	11	⚠
22:28 Fi ⚠	40	44	39	12	19	11	⚠
21:58	41	45	39	13	26	11	⚠
21:28	41	45	34	11	14	10	⚠
20:58	---	---	---	---	---	---	---
20:28	39	44	37	12	14	11	

ZOOM: 120 60 **30** 5 1 minutes

>Press UP/DOWN Keys to Move Cursor.

PAGE UP	ZOOM	ETCO2 MAIN	PAGE DOWN
---------	------	------------	-----------

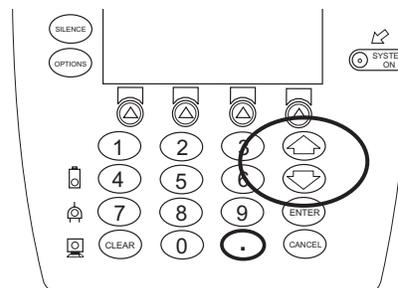

- To change **TIME** increments for data review, move cursor to desired time period and press **ZOOM** soft key.
 - New time increments display.
 - Each press of **ZOOM** soft key changes time increments.

2001-07-06		ETCO2		RR		09:00	
TIME	AVG	MAX	MIN	AVG	MAX	MIN	
22:58 Fi ⚠	40	44	39	12	16	11	⚠
21:58 Fi ⚠	41	45	39	13	20	11	⚠
21:28	41	45	34	11	14	10	⚠
20:58	---	---	---	---	---	---	---
20:28	39	44	37	12	14	11	
19:58	39	44	37	12	14	11	

ZOOM: 120 60 **30** 5 1 minutes

>Press UP/DOWN Keys to Move Cursor.

PAGE UP	ZOOM	ETCO2 MAIN	PAGE DOWN
---------	------	------------	-----------

Monitoring Mode (Continued)

Navigate Trend Data (Continued)

5. To return to **ETCO2 Main** display, press **ETCO2 MAIN** soft key.
6. To return to Main Display, press **MAIN SCREEN** soft key.

Navigate PCA/EtCO₂ Trend Data

To access and view shared trend data when a PCA Module is present, perform the following steps.

1. To view **ETCO2 Main** display, press **CHANNEL SELECT** key.
2. To access option to view trend data, press **OPTIONS** key.
3. To view **Trend Data**, press **PCA/EtCO₂ Trend data** soft key.

Following information is displayed:

- **TIME** period for data review.
 - Average **ETCO₂**.
 - Average respiratory rate (**RR**).
 - Alarm icon ().
 - **TOTAL DOSE** of medication infused through PCA Module (includes continuous infusion, loading dose, bolus, and PCA dose).
4. See "Navigate Trend Data" procedure for instructions on how to:
 - Navigate from page to page.
 - Change **TIME** increments.
 - Return to **ETCO₂ MAIN** display.
 - Return to Main Display.

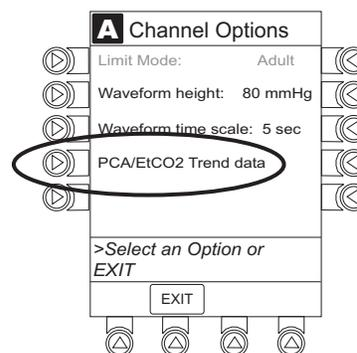

A Morphine 1mg/mL 09:00

2003-06-06 TIME	TOTAL DOSE (mg)	ETCO ₂ AVG	RR AVG
08:01	---	40	13 
08:02	2.55	40	12
08:03	1.2	41 	13
08:04	5.01	41 	11
08:05	---	---	---
08:06	2	39	12

ZOOM: 120 60 30 5 **1** minutes

>Press UP/DOWN Keys to Move Cursor.

ZOOM ETCO₂ MAIN PAGE DOWN

Monitoring Mode (Continued)

Presilence Alarm

1. To presilence alarm, press **SILENCE** key.
All monitoring alarms are silenced for 120 seconds.
Subsequent infusion alarms are not silenced.
2. To cancel presilence alarm and return to alarmable mode:
 - Press **CHANNEL SELECT** key.
 - Press **CANCEL SILENCE** soft key.

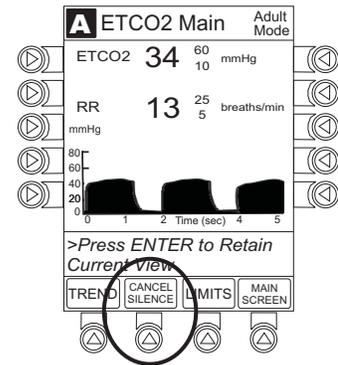
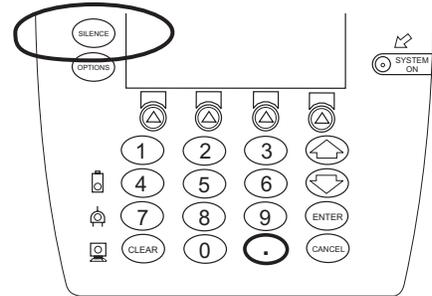

Channel Options

Change Limit Mode

The following procedure can be performed only when the Guardrails® Suite MX is not enabled (profile option not being used for programming).

1. Press **Limit Mode** soft key.

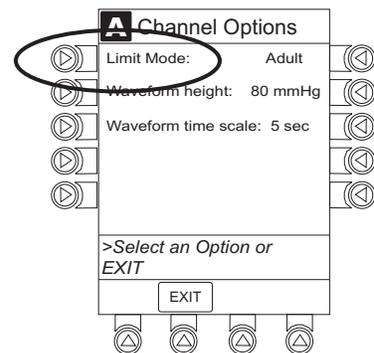

Channel Options (Continued)

Change Limit Mode (Continued)

2. To change **Limit Mode Setup**, press applicable soft key.

OR

To leave **Limit Mode Setup** unchanged and return to **ETCO₂ Main** display, press **EXIT** soft key.

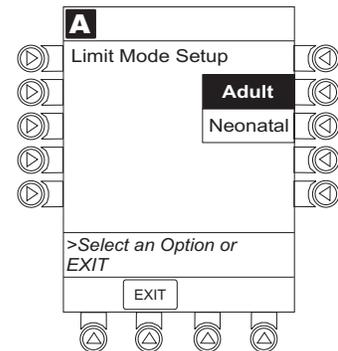

Change Waveform Height

1. Press **Waveform height** soft key.

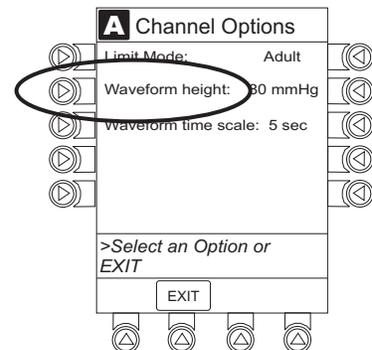

2. To change **Waveform Height**, select applicable range limit.

- **60 mmHg**: Displays a waveform for EtCO₂ values within 0 – 60 mmHg range. If EtCO₂ value exceeds that range, **Waveform Out of Range; Adjust Scaling** message is displayed until waveform falls back into range or 0 – 99 mmHg option is selected.
- **99 mmHg**: Displays a waveform for full EtCO₂ value range, 0 – 99 mmHg.

3. To return to **ETCO₂ Main** display, press **EXIT** soft key.

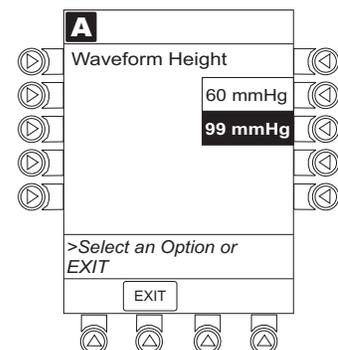

Channel Options (Continued)

Change Waveform Time Scale

1. Press **Waveform time scale** soft key.

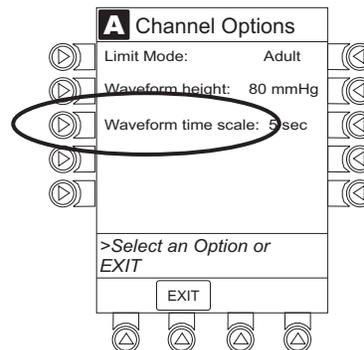

2. To change **Waveform Time Scale**, select applicable time scale.

OR

To leave **Waveform Time Scale** unchanged and return to **ETCO2 Main** display, press **EXIT** soft key.

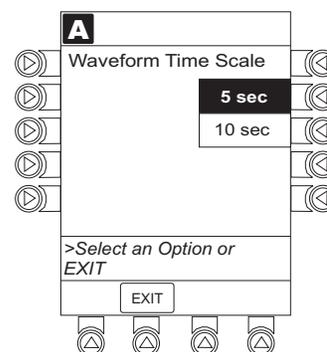

THIS PAGE
INTENTIONALLY
LEFT BLANK

System Start-Up/Setup

See the PC Unit section of this DFU, "General Setup and Operation," for various system start-up and setup procedures.

THIS PAGE
INTENTIONALLY
LEFT BLANK

Warnings and Cautions

General

WARNINGS

- **EtCO₂ and respiratory rate readings** can be affected by certain ambient environmental and patient conditions.
- The EtCO₂ Module is **not to be used as an apnea monitor**.
- The EtCO₂ Module is intended only as an **adjunct in patient assessment**. It must be used in conjunction with clinical signs and symptoms.
- If uncertain about **measurement accuracy**, assess patient's condition and vital signs by alternate means, then ensure that EtCO₂ Module is functioning correctly.
- **Do not lift** the EtCO₂ Module by Microstream® Disposable because it could disconnect from the instrument, causing it to drop on the patient. Do not place the EtCO₂ Module in any position that could cause it to fall onto the patient.
- Do not use the EtCO₂ Module or Microstream® Disposable inside a **hyperbaric chamber**.
- **Respond immediately to system alarms**; patient monitoring can cease under certain alarm conditions.

Microstream® Disposable

WARNINGS

- Do not use a connector or Microstream® Disposable that **appears damaged**.
- The Microstream® Disposable **disconnect error message** and associated alarm indicate the Microstream® Disposable is disconnected. Check the Microstream® Disposable connection and, if necessary, replace the Microstream® Disposable.
- **Use only Microstream® Disposables**. Use of a disposable other than those specified can cause improper EtCO₂ Module performance, resulting in inaccurate readings. For a list of compatible disposables, refer to the Microstream® Disposable Compatibility Card (provided separately).

Warnings and Cautions (Continued)

Microstream® Disposable (Continued)

WARNINGS

- Before use, read **Microstream® Disposable directions for use**, including all warnings, cautions and instructions.
- **Carefully locate the patient Microstream® Disposable** to reduce the possibility of patient entanglement or strangulation.

CAUTIONS

- **Do not immerse or dampen** the Microstream® Disposable.
- The Microstream® Disposables are **designed for single patient use** and are not to be reprocessed. Do not attempt to disinfect or flush the disposable as the EtCO₂ Module can be damaged.

Microstream® Disposable

When selecting a Microstream® Disposable, consider the patient's weight, condition and intubation status. For more information on Microstream® Disposables, contact Oridion at <http://www.oridion.com> or 1-888-ORIDION.

For a list of compatible disposables, refer to the Sensor and Cable Compatibility Card (provided separately).

Features and Displays

Features and Definitions

See the PC Unit section of this DFU for system features and definitions.

Feature	Definition
BPM	Breaths per minute.
Capnography Waveform	Real-time graphical display of CO ₂ concentration throughout respiration.
Data Display	Waveforms, trended data, and numerical values are displayed.
EtCO₂	CO ₂ concentration in mmHg at end of exhalation.
FiCO₂	Fractional-inspired CO ₂ ; CO ₂ concentration present during inhalation.
Limit Mode	Configurable mode that can be set to display either adult or neonatal monitoring mode. (See "Configurable Settings" for additional configurable features.)
Microstream® Disposable	Oridion's line of Microstream® Disposables are available for neonatal, pediatric, and adult patients. Patients can be intubated or nonintubated.
Programmable Alarm Limits	Alarm limits for EtCO ₂ , FiCO ₂ , respiration rates, and No Breath time periods are programmable.
Respiratory Rate	Patient's respiratory rate in breaths per minute (breaths/minute).
Trend Data	Tabular display of EtCO ₂ and respiratory rate. Display shows average, high, and low values and alarm conditions for time period displayed. Up to 24 hours of data is stored.

Features and Displays (Continued)

Operating Features, Controls, Indicators

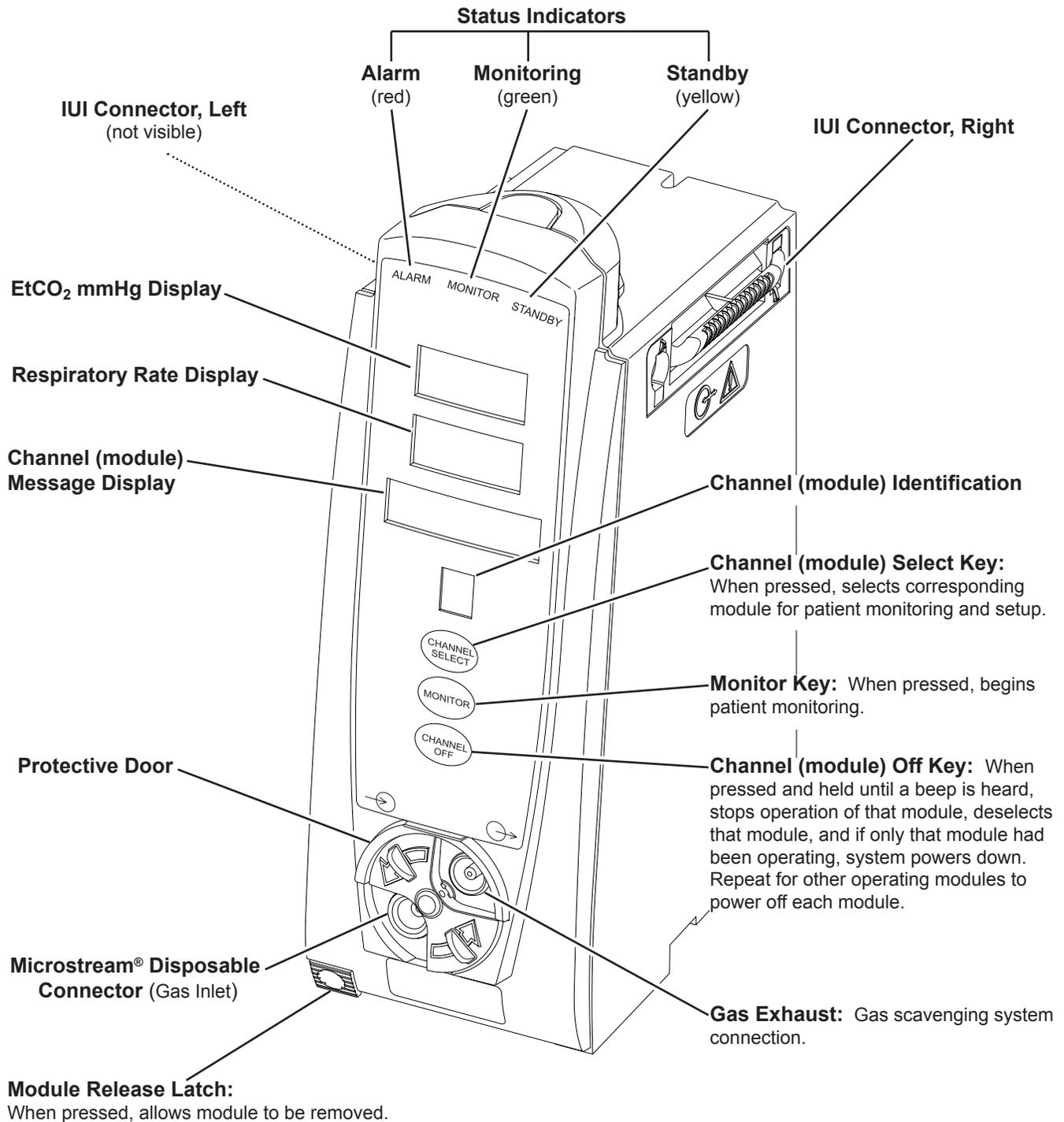

Features and Displays (Continued)

Displays

The displays illustrated throughout this document are for illustration purposes only. The display content varies, depending on configuration settings, type of disposable in use, hospital-defined Data Set uploaded using the Guardrails® Suite MX, programmed parameters, and many other variables.

Main Display

See the PC Unit section of this DFU.

Configurable Settings

See the PC Unit section of this DFU for system configurable settings.

If the configuration settings need to be changed from the **Factory default** settings, refer to the applicable Technical Service Manual or contact CareFusion Technical Support, for technical, troubleshooting, and preventive maintenance information.

With the Profiles feature enabled, the settings are configured independently for each profile. A hospital-defined, best-practice Data Set must be uploaded to enable the Profiles feature. Date and Time is a system setting and is the same in all profiles.

Feature	Default Setting	Options
EtCO ₂ Alarm Limit, High	Adult: 60 mmHg Neonatal: 60 mmHg	5 - 99 mmHg
EtCO ₂ Alarm Limit, Low	Adult: 10 mmHg Neonatal: 10 mmHg	0 - 98 mmHg
FiCO ₂ Alarm Limit, High	Adult: 8 mmHg Neonatal: 8 mmHg	2 - 99 mmHg
Limit Mode	Adult	Adult or Neonatal
No Breath Alarm	Adult: 30 seconds Neonatal: 20 seconds	10 - 60 seconds

Configurable Settings (Continued)

Feature	Default Setting	Options
Respiratory Rate Alarm Limit, High	Adult Mode: 35 bpm Neonatal Mode: 150 bpm	1 - 150 bpm
Respiratory Rate Alarm Limit, Low	Adult Mode: 6 bpm Neonatal Mode: 12 bpm	0 - 149 bpm

Specifications and Symbols

Specifications

Accuracy:

EtCO₂ readings:

CO ₂ Partial Pressure (at sea level)	Accuracy
0 - 38 mmHg	±2 mmHg
39 - 99 mmHg	± (5% of reading + 0.08% for every 1 mmHg above 38 mmHg)

Above 55°C module temperature, ±1 mmHg or 2.5% (whichever is greater), has to be added to tolerance of accuracy specifications.

Respiration rate, measured in range of 0 - 150 bpm with following accuracy:

0 - 70 bpm: ±1 bpm
71 - 120 bpm: ±2 bpm
121 - 150 bpm: ±3 bpm

Alarm Limits:

	Low	High
EtCO ₂	0 - 98 mmHg	5 - 99 mmHg
FiCO ₂	Not Applicable	2 - 99 mmHg
No Breath	10 - 60 sec	Not Applicable
Respiration Rate	0 - 149 breaths/min	1 - 150 breaths/min

Alarms:

Audible and visual alarms for high and low EtCO₂ and respiratory rate, high FiCO₂, Microstream® Disposable condition, system failure, no breath, and low battery conditions.

Barometric Pressure:

EtCO₂ Module is equipped with automatic barometric pressure compensation. There are no quantitative effects of barometric pressure for this device.

CO₂ Range:

Measures and reports partial pressures of CO₂ in the range of 0 - 99 mmHg at sea level. EtCO₂ and FiCO₂ values are calculated for all valid breaths.

Specifications and Symbols (Continued)

Specifications (Continued)

Dimensions: 3.3" W x 8.9" H x 5.5" D
(8.4 cm W x 22.6 cm H x 14 cm D)

Environmental Conditions:

	Operating	Storage/Transport
Altitude	-380 - 4570 m (-1250 - 15,000 ft)	-380 - 4570 m (-1250 - 15,000 ft)
Atmospheric Pressure	525 - 795 mmHg (700 - 1060 hPa)	375 - 760 mmHg (500 - 1013 hPa)
Relative Humidity	20 - 90% Noncondensing	5 - 85% Noncondensing
Sound Pressure	34.9 db	Not Applicable
Temperature Range	41 - 104°F (5 - 40°C)	-4 - 140°F (-20 - 60°C)

Flow Rate: Nominally 50 mL/min -7.5 +15 mL/min

Fluid Ingress Protection: IPX1, Drip Proof

Frequency Response: EtCO₂ accuracy applies for breath rates of up to 80 bpm. For maintaining accuracy for respiration rates above 80 bpm, accuracy is 4 mmHg or ±12% of reading, whichever is greater, for EtCO₂ values exceeding 18 mmHg. To achieve specified accuracies for breath rates above 60 bpm, Microstream® neonatal airway adapter M1996A must be used.

Gas Interference: Following liquid anesthetics have been tested and were found to have no effect:
Desflurane
Enflurane
Halothane
Isoflurane
Sevoflurane

Internal Power Source: Operating time (fully charged): 5.5 hours

Measurement Range: EtCO₂: 0 - 99 mmHg
FiCO₂: 0 - 99 mmHg
Respiratory Rate: 0 - 150 bpm

Mode of Operation: Continuous

Shock Protection: Type BF, Defibrillator Proof

Specifications and Symbols (Continued)

Specifications (Continued)

System Response Time:	EtCO ₂ Module response: 2.9 seconds typical (includes rise time of 190 msec maximum and delay time of 2.7 seconds typical). PC Unit display response: approximately ½ second longer than EtCO ₂ Module response.
Warm-Up Time:	30 seconds typical
Weight:	2.5 lbs (0.91 kg)

Symbols

See the PC Unit section of this DFU for system symbols.

Symbol	Meaning
	Type BF defibrillation-proof equipment.
	Gas inlet.
	Gas outlet.
	Silenced alarm. Note: When displayed, the dashed lines through the symbol might appear as solid lines due to the small display size.
	Is displayed in Trend Data screen to identify an exceeded alarm limit.
	Is displayed in Trend Data screen to identify an exceeded no breath alarm limit.

Measurement Accuracy

The EtCO₂ Module has been designed and manufactured to exacting standards and should perform well within given environmental and performance standards. There are certain conditions under which an inaccurate measurement or the loss of respiratory rate signal can occur.

An inaccurate EtCO₂ measurement can be caused by:

- Incorrect disposable application or use.
- Microstream® Disposable disconnected or not securely connected to EtCO₂ Module.
- Airway connection clogged, twisted, or leaking.
- Placement too close to electrosurgery equipment.
- Mechanically ventilated patient breathes spontaneously.

Loss of a respiratory rate signal can occur in any of the following situations:

- Incorrect disposable application or use.
- Microstream® Disposable disconnected or not securely connected to EtCO₂ Module.
- Airway connection clogged, twisted, or leaking.
- Patient not breathing.
- Placement too close to electrosurgery equipment.

WARNINGS

- If uncertain about **measurement accuracy**, assess patient's condition and vital signs by alternate means, then ensure that EtCO₂ Module is functioning correctly.
- **Leaks or internal venting** of sampled gas can affect accuracy.

Waveform Analysis

The EtCO₂ Module provides the option to display EtCO₂ readings as a waveform. The following graph is an example of a normal waveform (normal ventilation, 35 - 45 mmHg). In the event the EtCO₂ value is above the waveform display range, the top of the waveform will be clipped. Numerical EtCO₂ values continue to be displayed on both the EtCO₂ Module and PC Unit.

- A - B:** baseline period of no CO₂; end of inhalation
B - C: rapid rise in CO₂
C - D: alveolar plateau
D: end of expiration; end tidal CO₂ (EtCO₂)
D - E: inhalation

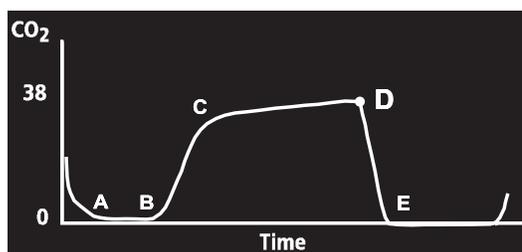

Waveform Analysis (Continued)

Waveforms can be used to troubleshoot problems with equipment or monitor configuration, as well as to monitor a patient's clinical status. The following graphs are examples of common problems identifiable through waveform analysis. These are examples only and do not represent all potential abnormal waveforms. Abnormal waveforms are not always associated with alarms.

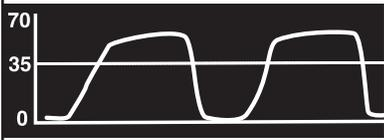
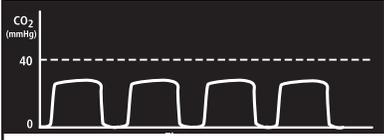
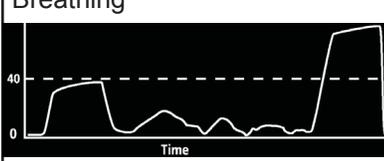
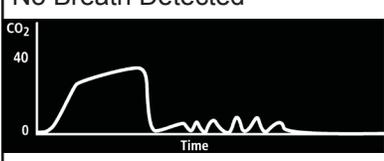
Waveform	Possible Causes
<p>Hypoventilation</p> 	<ul style="list-style-type: none"> • overmedication
<p>Hyperventilation</p> 	<ul style="list-style-type: none"> • respiratory distress
<p>Partial Airway Obstruction</p> 	<ul style="list-style-type: none"> • relaxation of upper airway • head position
<p>Hypoventilation with Shallow Breathing</p> 	<ul style="list-style-type: none"> • medication effect • low tidal volume
<p>No Breath Detected</p> 	<ul style="list-style-type: none"> • apnea • very shallow breathing • overmedication • displaced cannula

Principle of Operation

The EtCO₂ Module uses Oridion's patented Microstream[®] nondispersive infrared (NDIR) spectroscopy to continuously measure the amount of CO₂ during every breath, the amount of CO₂ present at the end of exhalation (EtCO₂) and during inhalation (FiCO₂), and the Respiratory Rate. The EtCO₂ Module is a side stream capnograph.

The Microstream[®] Disposables deliver a sample of the inhaled and exhaled gases from the ventilator disposable or directly from the patient (via an oral/nasal cannula) into the monitor for CO₂ measurement. Moisture and patient secretions are extracted from the sample by the Microstream[®] inline filter while maintaining the shape of the CO₂ waveform.

The 50 mL/min sampling flow rate reduces liquid and secretion accumulation, decreasing the risk of obstruction in the sample pathway in humid ICU environments. The small sample size eliminates the need for water traps and prevents excess fluid accumulation.

The EtCO₂ Module draws a gas sample through a microsample cell (15 microliters). This extremely small volume is quickly flushed, allowing for a rise time of approximately 190 ms and accurate CO₂ readings, even at high respiration rates.

The Microbeam IR source illuminates the microsample cell and the reference channel. This proprietary IR light source generates only the specific wavelengths characteristic of the CO₂ absorption spectrum. The IR light that passes through the microsample cell and the IR light that passes through the reference channel are measured by IR detectors.

The microcomputer in the EtCO₂ Module calculates the CO₂ concentration by comparing the signals from both channels.

No operator intervention is required for routine moisture or condensate.

All Microstream[®] Disposables contain an inline hydrophobic filter to extract condensate and/or patient secretions while maintaining measurement and waveform integrity. For humid conditions within the operating parameters of the EtCO₂ Module and Microstream[®] Disposables, humidity has no quantitative effect on the CO₂ concentration, given the small 50 mL/min sample size rate. In high humidity environments or extended monitoring periods (24 - 72 hours), only Microstream[®] Disposables designed for those instances should be used.

Principle of Operation (Continued)

In the event of humidity or condensate outside the EtCO₂ Module's operating specifications, the EtCO₂ Module will present a "Remove Blocked Disposable" message.

Due to the relatively small sampling size needed for EtCO₂ readings, partial pressure does not affect the ability of the EtCO₂ Module to measure EtCO₂, as long as the 50 mL/min rate can be achieved.

Microstream® Disposables are single-use, disposables which must be changed with each use. The manufacturer's sample flow, 50 mL/min, does not affect the disposable's life; however, humidity and specific patient conditions can shorten the effective life of the disposables. Microstream® Disposables are rated for up to 24 hours and 72 hours use, depending on the specific Microstream® Disposable.

The EtCO₂ Module provides readings in compliance with BTPS (body temperature, pressure, saturation) standards.^① There is no affect on accuracy due to cyclic pressure up to 10 kPa.

NOTE:

- ① BTPS (body temperature, pressure, saturation assumed 37°C, 47 mmHg) calculations are made according to:

$$PCO_2 = FCO_2 \times (Pb - 47)$$

Where:

FCO₂ is fractional concentration of CO₂ in dry gas and

FCO₂ = % CO₂/100.

Pb is ambient pressure.

PCO₂ is partial pressure of CO₂ at BTPS.

Troubleshooting and Maintenance

General

Troubleshooting and maintenance are intended to be performed only by qualified personnel, using the EtCO₂ Module Technical Service Manual and the System Maintenance software. The Service Manual and System Maintenance software are available from CareFusion. The Service Manual includes routine service schedules, interconnect diagrams, component parts lists and descriptions, test procedures, and other technical information to assist qualified service personnel in repair and maintenance of the instrument's repairable components. The System Maintenance software is used to perform a new instrument check-in, preventive maintenance tests, calibration checks, calibration, and other maintenance functions.

Alarms and Messages

See the PC Unit section of this DFU for the following system references:

Alarms, Errors, Messages
Audio Characteristics
Definitions
Radio Frequency Note

Definitions

- | | |
|--------------------------|--|
| Alarm Silence | Alarms can be silenced for up to 120 seconds by pressing SILENCE key. Alarm indicators remain on and alarm silence symbol is displayed. Silence period can be ended by pressing CANCEL SILENCE soft key. |
| Calibration Check | A technical procedure, outlined in Technical Service Manual to verify instrument calibration. |

Alarms and Messages (Continued)

Audio Characteristics

Type	Sound	Note
EtCO ₂ Alarm (HIGH PRIORITY)	A sequence of five beeps.	Variable volume; can be silenced for 2 minutes.
EtCO ₂ Alarm (LOW PRIORITY)	One long beep approximately every 4 seconds.	Variable volume; can be silenced for 2 minutes.
EtCO ₂ Error (Hardware Detected)	A single alarm tone volume.	Fixed maximum decibel volume; cannot be silenced.
EtCO ₂ Error (Software Detected)	Pairs of long beeps.	Fixed maximum decibel volume; can be silenced for 2 minutes.

Alarms

High Priority Alarm	Meaning	Response
CHANNEL ERROR	Hardware failure detected by software.	To silence alarm and continue operation of unaffected instrument, press CONFIRM soft key. Replace module, as needed.
DISPOSABLE DISCONNECTED	Microstream® Disposable removed from instrument during monitoring mode.	Attach Microstream® Disposable to instrument.
HIGH ETCO2	EtCO ₂ value is above specified limit.	Assess patient condition. Confirm correct alarm limit values are selected.
HIGH FICO2	FiCO ₂ value is above specified limit	Assess patient condition. Confirm correct alarm limit values are selected.
HIGH RR	Respiratory rate is above specified limit.	Assess patient condition. Confirm correct alarm limit values are selected.
LOW ETCO2	EtCO ₂ value is below specified limit.	Assess patient condition. Confirm correct alarm limit values are selected.

Alarms and Messages (Continued)

Alarms (Continued)

High Priority Alarm	Meaning	Response
LOW RR	Respiratory rate is below specified limit.	Assess patient condition. Confirm correct alarm limit values are selected.
NO BREATH DETECTED	No breath detected for a specified period of time.	Assess patient condition. Check Microstream® Disposable. Confirm correct disposable is chosen and correct disposable placement.
Low Priority Alarm		
Disconnect Occluded Disposable	Purging operation failed.	Check Microstream® Disposable. Obtain a new Microstream® Disposable. Attach Microstream® Disposable to patient and module.

Messages

Message	Meaning	Response
Autozero (in progress)	EtCO ₂ Module performs a baseline by sampling CO ₂ present in ambient air.	Wait for instrument to complete its auto-zeroing function. After auto-zero cycle is complete, instrument begins measurement again. No user intervention is required.
Clearing Disposable	Microstream® Disposable blocked.	Check Microstream® Disposable. Wait for purging to complete.
Disposable Disconnected	No Microstream® Disposable present and instrument not in monitoring mode.	Attach Microstream® Disposable to patient and instrument to begin monitoring.
Patient Not Detected	Monitor or Channel Select key pressed and patient not detected.	Assess patient condition. Check disposable.

Inspection Requirements

To ensure that the Alaris® System remains in good operating condition, both regular and preventive maintenance inspections are required. Refer to the System Maintenance software for detailed instructions.

REGULAR INSPECTIONS

PROCEDURE	FREQUENCY
INSPECT FOR DAMAGE: <ul style="list-style-type: none">• Exterior Surfaces• IUI Connector• Keypad	<ul style="list-style-type: none">• Each usage• Each usage• Each usage
CLEANING	As required
START-UP	Each usage

WARNING

Failure to perform these inspections can result in improper instrument operation.

CAUTION

Preventive maintenance inspections should only be performed by qualified service personnel.

Alaris® Auto-ID Module Model 8600

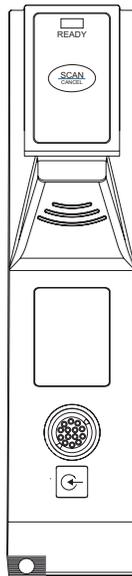

Getting Started

Introduction	6-1
--------------------	-----

Programming

Patient Identification	6-3
New Patient	6-3
While Infusion is in Progress	6-4
Authorized User Mode	6-5
Primary Infusion	6-6
Secondary Infusion	6-7

General Setup and Operation

System Start-Up/Setup	6-9
-----------------------------	-----

General Information

Warnings and Cautions	6-11
Handheld Scanner	6-11
Features	6-12
Features and Definitions	6-12
Operating Features, Controls, Indicators	6-13
Configurable Settings	6-14
Specifications and Symbols	6-14
Specifications	6-14
Symbology	6-15
Symbols	6-15

Troubleshooting and Maintenance

General	6-17
Errors and Messages	6-17
Errors	6-17
Messages	6-18
Inspection Requirements	6-18

THIS PAGE
INTENTIONALLY
LEFT BLANK

Introduction

This section of the DFU provides Auto-ID Module (Model 8600) instructions and information. It is used in conjunction with:

- Auto-ID Label Specification
- Auto-ID Module Technical Service Manual
- Module-specific sections of this DFU
- PC Unit section of this DFU
- System Maintenance software (and its instructions) for Alaris® System check-in, maintenance, and wireless configuration

The addition of the Auto-ID Module to the Alaris® System combines Guardrails® Suite MX with dose limit technology and bar code technology to provide a new level of medication safety. The Auto-ID Module contains an internal bar code image scanner and supports an optional handheld scanner supplied by CareFusion. Scanning a bar-coded clinician ID and/or a bar-coded patient identification band automatically verifies the correct patient and associates the CQI event logs with the clinician and/or patient. In addition, using the scanner allows an IV solution drug and concentration to be automatically selected from the Drug Library. Scanned solution containers can be used for Pump, Syringe and PCA infusions. Only one Auto-ID Module can be connected to the Alaris® System but it can be added as a fifth module.

The Alaris® System with the Auto-ID Module is intended to provide trained healthcare caregivers a way to automate infusion parameter input, thereby decreasing the number of manual steps necessary to enter infusion data. All data entry and infusion parameter validation is performed by the trained healthcare professional according to a physician's order.

Electromagnetic Environment: See "Appendix" section of this DFU ("Regulations and Standards," "Compliance").

WARNING

Read all instructions, for both the Auto-ID Module and PC Unit, before using the Alaris® System.

CAUTION

Rx Only

THIS PAGE
INTENTIONALLY
LEFT BLANK

Patient Identification

Associating the PC Unit with a patient provides a means of identifying the module(s) that will deliver IV medications to that particular patient.

New Patient

To associate the PC Unit with a new patient ID:

1. Attach handheld scanner to connection port on Auto-ID Module. Ensure secure circuit connection.
2. Power on PC Unit.
3. To select **New Patient?**, press **Yes** soft key.
4. To accept current profile, press **Yes** soft key.

OR

To proceed to profile selection screen, press **No** soft key.

5. To accept profile selection, press **CONFIRM** soft key.
 - **Patient ID Entry** screen appears. ①
 - Green **READY** indicator illuminates, indicating system is ready to scan.

WARNING

Use only the handheld external scanner supplied by CareFusion. Using other accessories can result in **increased emissions or decreased immunity** of the Alaris® System.

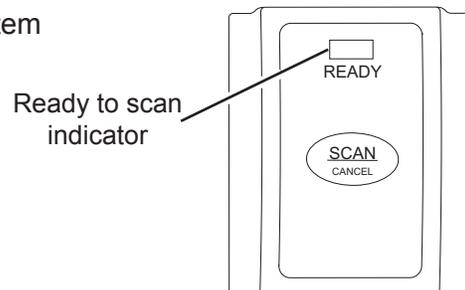

Patient Identification (Continued)

New Patient (Continued)

6. To scan bar code on patient identification band, press scan trigger on handheld scanner. ^{② ③}
 - If scan is successful, an audible tone sounds and patient ID appears on Main Display.
 - If profile is configured in Authorized User Mode, **PANEL LOCKED** screen appears.
 - When a questionable bar code is scanned at main screen and panel is unlocked, a prompt to confirm type of bar code scanned appears. This occurs whether Authorized User Mode is enabled or disabled.
7. To unlock panel, clinician's ID must be scanned.

NOTES:

- ① Automatic display of **Patient ID Entry** screen should be enabled in the System Configuration settings.
- ② If the patient ID is not entered at this time, it can still be entered later.
- ③ Patient ID can be entered manually using the PC Unit keypad (see PC Unit section of this DFU).

While Infusion is in Progress

To associate the PC Unit with a patient ID when patient ID screen is not shown:

1. Attach handheld scanner to connection port on Auto-ID Module. Ensure secure circuit connection.
2. To scan bar code on patient identification band, press scan trigger on handheld scanner. ^①

If scan is successful, an audible tone sounds and patient ID appears on Main Display.

NOTE:

- ① Patient ID can be entered manually using the PC Unit keypad (see PC Unit section of this DFU).

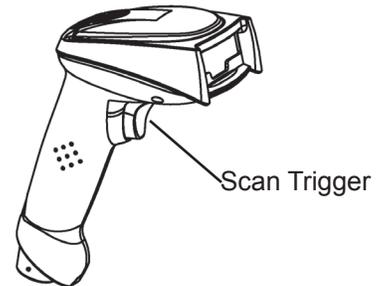

CAUTIONS

- **CLASS 1 LED PRODUCT:** Do not stare into the beam or allow beam to strike patient's face.
- **Always verify** that information displayed on the PC Unit matches scanned data.

CAUTIONS

- **CLASS 1 LED PRODUCT:** Do not stare into the beam or allow beam to strike patient's face.
- **Always verify** that information displayed on the PC Unit matches scanned data.

Authorized User Mode

Authorized User Mode is a feature that:

- Combines PC Unit tamper resist feature with Auto-ID application.
- Is designed to ensure that only clinicians with a bar code on their ID badge can program Alaris® System.
- Is available only if it is enabled in selected profile and there is an Auto-ID Module attached.

When this feature is enabled, the PC Unit automatically enables the tamper resist mode upon power on and 5 minutes after programming is completed. If the system is configured to do so, the Authorized User Mode can be disabled without scanning a clinician's ID; press and hold the Tamper Resist Switch (on back of PC Unit) for 3 - 4 seconds.

To unlock the keypad, the user must scan their ID badge or use the **OPTIONS** menu to manually input their ID number. When a questionable bar code is scanned at the main screen and the keypad is unlocked, a prompt to confirm the type of bar code scanned appears. This occurs whether the Authorized User Mode is enabled or disabled.

To use Alaris® System with Authorized User Mode enabled:

1. Power on system and associate patient ID (see "Patient Identification" procedure).

Upon successful entry of patient ID, PC Unit automatically enables tamper resist feature.

2. To disable tamper resist, press **SCAN** key and scan clinician ID badge.

In a very low battery condition, with less than 5 minutes of battery time remaining, scanner is disabled. In this situation, disable tamper resist by pressing Tamper Resist Switch on back of PC Unit for approximately 2 seconds.

3. Program infusion.

When no keys have been pressed on PC Unit for a 5-minute period, tamper resist mode is automatically enabled.

Primary Infusion

Utilizing the Auto-ID Module to scan IV medication containers provides the ability to verify the right medication and concentration, and enhances safety through the use of the Guardrails® Suite MX. It compares the medication identifier from the IV container bar code with the medication identifier from the Drug Library. If the patient ID is in the IV container bar code, the system also verifies the right patient.

When the green **READY** indicator illuminates, the system is ready to scan.

1. To scan bar code on IV container, press **SCAN/CANCEL** key on Auto-ID Module or scan trigger on handheld scanner.

2. Press **CHANNEL SELECT** key on appropriate module.

Alaris® System determines if module selected is appropriate for scanned medication type. If selection is not appropriate (for example, a bag was scanned but a PCA Module was selected), a pop-up warning is displayed with a request to **CONFIRM** message, and scan is cancelled.

3. Program infusion (see applicable module-specific section of this DFU).

If a continuous Guardrails® infusion is running, system checks to verify that scanned and infusing medication and concentration are the same. If not, an error message is displayed with a request to **CONFIRM** message, and scan is cancelled.

CAUTIONS

- **CLASS 1 LED PRODUCT:** Do not stare into the beam or allow beam to strike patient's face.
- **Always verify** that information displayed on the PC Unit matches scanned data.

Secondary Infusion

To start a secondary infusion while a primary infusion is in progress:

1. To scan bar code on IV container, press **SCAN/CANCEL** key on Auto-ID Module or scan trigger on handheld scanner.
2. Press **CHANNEL SELECT** key on appropriate module.
Primary infusion parameters display.
3. Press **SECONDARY** soft key.
4. Program secondary infusion (see Pump Module section of this DFU).

CAUTIONS

- **CLASS 1 LED PRODUCT:** Do not stare into the beam or allow beam to strike patient's face.
- **Always verify** that information displayed on the PC Unit matches scanned data.

THIS PAGE
INTENTIONALLY
LEFT BLANK

System Start-Up/Setup

See the PC Unit section of this DFU, "General Setup and Operation," for various system start-up and setup procedures.

THIS PAGE
INTENTIONALLY
LEFT BLANK

Warnings and Cautions

WARNINGS

- Do not open the handheld scanner case. If the case is opened, an electrical shock hazard and possible exposure to **potentially hazardous LED light** exists which can result in serious personal injury and product damage.
- Carefully locate the handheld scanner to reduce the possibility of patient **entanglement or strangulation**.
- Use only the handheld external scanner supplied by CareFusion. Using other accessories can result in **increased emissions or decreased immunity** of the Alaris® System.

CAUTION

Class 1 LED devices are safe under reasonably foreseeable conditions of operation, including the use of optical instruments for intrabeam viewing. To **avoid potential harm**, avoid looking into the beam or allowing the beam to strike the patient's face.

Handheld Scanner

The handheld external scanner supplied by CareFusion is the only handheld scanner approved for use with the Auto-ID Module.

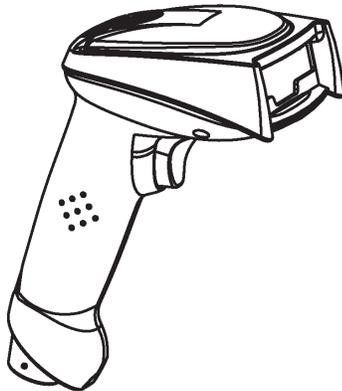

WARNINGS

- Do not open the handheld scanner case. If the case is opened, an electrical shock hazard and possible exposure to **potentially hazardous LED light** exists which can result in serious personal injury and product damage.
- Use only the handheld external scanner supplied by CareFusion. Using other accessories can result in **increased emissions or decreased immunity** of the Alaris® System.

CAUTION

CLASS 1 LED PRODUCT: Do not stare into the beam or allow beam to strike patient's face.

Features

Features and Definitions

See the PC Unit section of this DFU for system features and definitions.

Feature	Definition
Audible Scan Indicator	Provides audible confirmation of a successful scan.
Bar Code	A machine-readable label used for automatic identification. Automatic identification (Auto-ID) is the broad term given to a host of technologies used to help machines identify objects and is often coupled with automatic data capture. These technologies include bar codes, smart cards, voice recognition, some biometric technologies (for example, retinal scans), optical character recognition, and others.
Built-In Optical Scan Engine	Employs technology similar to a digital camera to read bar codes. Allows use of two-dimensional bar codes.
Handheld Scanner with Optical Scan Engine	Allows scanning of patient ID, and of IV containers that have already been hung on IV pole.
Light Emitting Diode (LED)	Bar code scanner uses an array of high intensity LEDs to illuminate bar code image (see "Specifications").
Two-Dimensional Bar Code	Can contain more information and is more easily read by Auto-ID Module; for example, patient ID and drug ID can be in same bar code.

Features (Continued)

Operating Features, Controls, Indicators

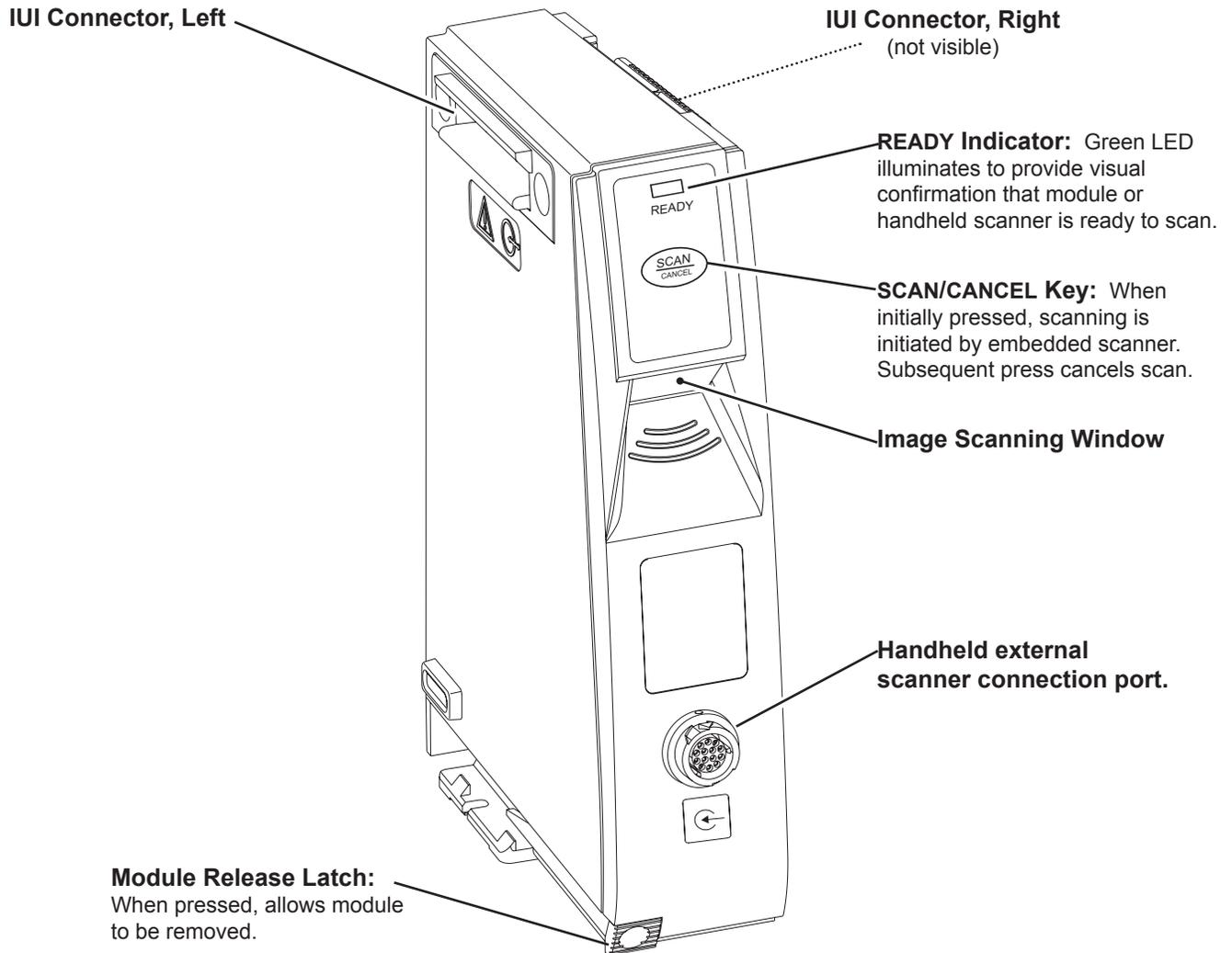

Configurable Settings

See the PC Unit section of this DFU for system configurable settings.

If the configuration settings need to be changed from the **Factory default** settings, refer to the applicable Technical Service Manual or contact CareFusion Technical Support, for technical, troubleshooting, and preventive maintenance information.

With the Profiles feature enabled, the settings are configured independently for each profile. A hospital-defined, best-practice Data Set must be uploaded to enable the Profiles feature. Date and Time is a system setting and is the same in all profiles.

Specifications and Symbols

Specifications

Auto-ID Module and Handheld Scanner

Environmental Conditions:

	Operating	Storage/Transport
Atmospheric Pressure	525 - 4560 mmHg (700 - 6080 hPa)	375 - 760 mmHg (500 - 1013 hPa)
Relative Humidity	20 - 90% Noncondensing	5 - 85% Noncondensing
Temperature Range	41 - 104°F (5 - 40°C)	-4 - 140°F (-20 - 60°C)

LED Light:

Class 1 LED product.

Aiming LED: 523 nm, cw, 0.412 mW average radiant power

Illumination LED: 635 nm, cw, 2.226 mW average radiant power

Auto-ID Module

Dimensions:

2.0" W x 7.25" H x 5.0" D
(5.1 cm W x 19.8 cm H x 12.7 cm D)

Electronic Memory:

System configuration parameters stored in volatile memory are retained for at least 6 months by PC Unit internal backup lithium battery. Module-specific Auto-ID parameters are stored for 8 hours by PC Unit when system is turned off. After 8 hours of continuous off time, or if module is changed, system automatically purges module-specific information

Specifications and Symbols (Continued)

Specifications (Continued)

Auto-ID Module

Fluid Ingress Protection:	IPX1, Drip Proof
Mode of Operation:	Continuous
Shock Protection:	Type BF
Weight:	1 ±0.1 lb (436.5 ±43.65 g)

Handheld Scanner

Dimensions:	3.25" W x 7.25" H x 4.25" L (8.3 cm W x 18.4 cm H x 10.8 cm L)
Housing:	UL 94V0 flammability rating
Weight:	6.5 oz (178 g)

Symbology

The Auto-ID Module supports an optional handheld scanner that can be used to scan a patient's ID, medication labels and clinician badges. The Auto-ID Module and handheld scanner read printed bar codes which are within the bar code print quality guidelines specified by ANSI X 3.182, CEN EN 1635, and ISO/IEC 15416 international standards. Some manufacturer-applied bar codes on IV bags are not compliant with these quality standards and might not be readable with the Auto-ID Module and handheld scanner. Refer to the Auto-ID Label Guidelines for more detailed bar code label information.

Symbols

See the PC Unit section of this DFU for system symbols.

Symbol	Meaning
	Input. Handheld connection point.

THIS PAGE
INTENTIONALLY
LEFT BLANK

Troubleshooting and Maintenance

General

Troubleshooting and maintenance are intended to be performed only by qualified personnel, using the Auto-ID Module Technical Service Manual and the System Maintenance software. The Service Manual and System Maintenance software are available from CareFusion. The Service Manual includes routine service schedules, interconnect diagrams, component parts lists and descriptions, test procedures, and other technical information to assist qualified service personnel in repair and maintenance of the instrument's repairable components. The System Maintenance software is used to perform a new instrument check-in, preventive maintenance tests, and other maintenance functions.

Errors and Messages

See the PC Unit section of this DFU for the following system references:

Alarms, Errors, Messages
Audio Characteristics
Definitions
Radio Frequency Note

Errors

Error	Meaning	Response
Clinician ID is invalid	Clinician ID is not recognized.	Ensure that ID label is legible. Enter ID manually.
Patient ID is invalid	Patient ID is not recognized.	Ensure that ID label is legible. Enter ID manually.
Patient ID mismatch	Bar code might not contain pertinent data. Drug might not be available in profile.	Ensure that correct profile is selected and that it has correct drug and concentration.
Scanned label is invalid	Profile feature might be disabled. Bar code might not be readable or a supported symbology.	Ensure that profile is enabled. Ensure that ID label is legible. Inform pharmacy of problem.
Scanned medication label is invalid	Bar code might not be readable or a supported symbology.	Ensure that ID label is legible. Inform pharmacy of problem.

Errors and Messages (Continued)

Messages

Message	Meaning	Response
Drug or Fluid not in current profile	Drug and its concentration might not be in currently selected profile.	Ensure that correct profile is selected and that it has correct drug and concentration.

Inspection Requirements

To ensure that the system remains in good operating condition, both regular and preventive maintenance inspections are required. Refer to the System Maintenance software for detailed instructions.

WARNING

Failure to perform these inspections can result in improper instrument operation.

REGULAR INSPECTIONS

PROCEDURE	FREQUENCY
INSPECT FOR DAMAGE: <ul style="list-style-type: none">• Exterior Surfaces• IUI Connector• Keypad• Mechanical Parts	<ul style="list-style-type: none">• Each usage• Each usage• Each usage• Each usage
CLEANING	As required
START-UP	Each usage

CAUTION

Preventive maintenance inspections should only be performed by qualified service personnel.

Nurse Call Accessory Model 8010

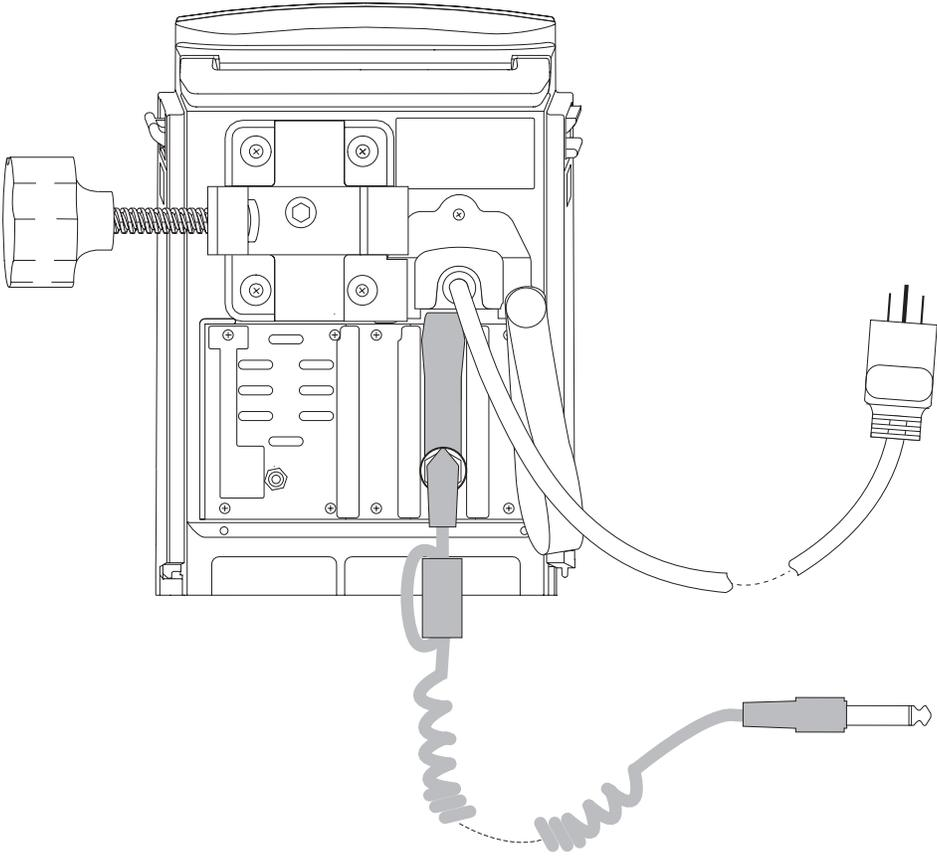

Introduction 7-1

General Information

- Warnings and Cautions 7-3
- Nurse Call Jack and Cable 7-4
 - Nurse Call Location 7-4
 - Nurse Call Cable Connected 7-4
- Specifications 7-5

Troubleshooting and Maintenance

- General 7-7
- Alarms, Errors, Messages 7-7

THIS PAGE
INTENTIONALLY
LEFT BLANK

This section of the DFU provides Nurse Call Accessory (Model 8010) instructions and information. It is used in conjunction with:

- Module-specific sections of this DFU
- PC Unit section of this DFU
- Communications Interface Board (CIB) Accessory section of this DFU (if a Nurse Call and CIB Combination Accessory is installed) ^①

The Nurse Call Accessory is an optional board installed in the PC Unit. It allows a nurse call system to be alerted when there is a significant alarm condition to the system. A contact closure routes the nurse call signal to the hospital-supplied nurse call system, and can either light a room light or send a signal/message to a console at the nurse station. A hospital-supplied cable is used to connect the Nurse Call Accessory to the hospital's nurse call jack within the patient's room. The wiring from the room to the nurse station is also hospital-supplied.

The Nurse Call Accessory uses a standard ¼" phone jack located on the rear panel of the PC Unit. A cover for the jack opening is supplied with the Nurse Call Accessory. The cover, used when the nurse call is not connected, prevents unwanted fluids and dust from entering the PC Unit.

The PC Unit is autoconfigurable and detects the presence of the nurse call option. It cannot, however, detect whether or not the nurse call cable is connected; therefore, it is important that the operation of the nurse call system be tested before each use by causing an alarm and verifying actuation of the nurse call remote alarm indication. To test the system, a module must be attached. See the applicable module-specific section of this DFU for alarm conditions.

NOTE:

- ① The CIB Accessory can be used in conjunction with a Nurse Call Accessory only if a Nurse Call and CIB Combination Accessory is installed.

WARNING

Read all instructions, including those for the PC Unit and attached module(s), before using the Alaris® System.

THIS PAGE
INTENTIONALLY
LEFT BLANK

Warnings and Cautions

WARNINGS

- The nurse call feature should not be used as the primary source of alarm notification. The **audible and visual alarms** of the Alaris® System, used in conjunction with clinical signs and symptoms, are the primary sources providing notification that an alarm condition exists.
- **Before each use**, ensure that the nurse call cable is fully inserted into the jack, and test the operation of the nurse call system by causing an alarm and verifying proper nurse call operation.

CAUTIONS

- To assure **compliance with Electromagnetic Compatibility** Standards (IEC 60601-1-2), the nurse call option must only be used with a properly configured hospital interface cable assembly. The approved hospital nurse call interface cable consists of an MCM Electronics 24-660 cable with an attached Fair-Rite Suppressor Core Assembly. The Fair-Rite part is included with the Nurse Call Accessory. Refer to the cable assembly instructions, included with the Nurse Call Accessory, for additional information.
- **When moving the PC Unit**, ensure that the nurse call cable is disconnected from the nurse call jack on the PC Unit and the fluid seal covers the jack opening.
- **Carefully route cabling** to reduce the possibility of entanglement that could result in a tripping hazard.

Nurse Call Jack and Cable

Nurse Call Location

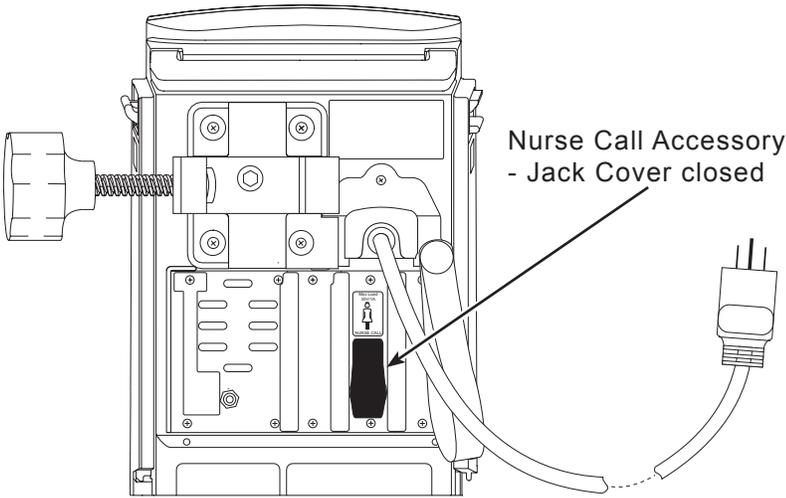

CAUTION

To prevent fluid contamination/ingress, always **close the Jack Cover** when the Nurse Call option is not in use.

Nurse Call Cable Connected

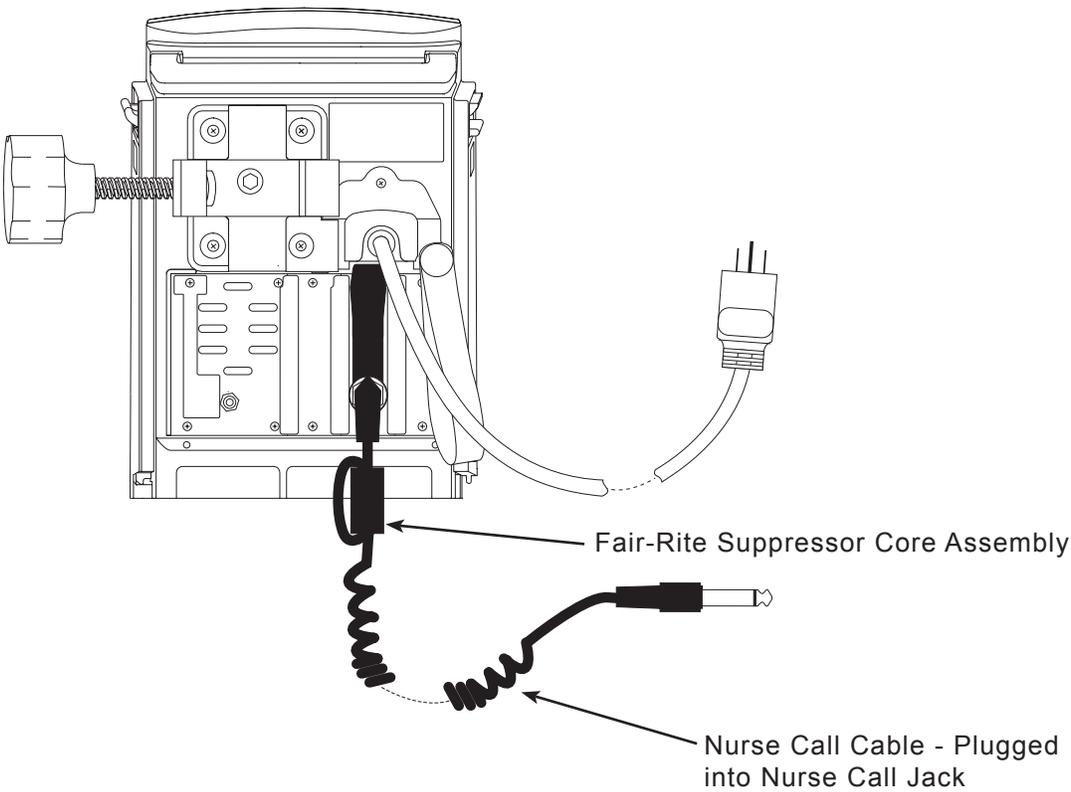

Specifications

Contact Closure Rating:	30 VDC maximum at 1A maximum
Drip Proof Protection:	To ensure that Alaris® System fluid ingress rating, Nurse Call jack is covered/ sealed when not in use.
Isolation:	Nurse Call contacts are isolated from chassis up to 500 VAC.
User Accessible Connector:	¼" phone jack

THIS PAGE
INTENTIONALLY
LEFT BLANK

Troubleshooting and Maintenance

General

Troubleshooting and maintenance are intended to be performed only by qualified personnel, using the Alaris® System Technical Service Manuals and the System Maintenance software. The Service Manuals and System Maintenance software are available from CareFusion. The Service Manuals include routine service schedules, interconnect diagrams, component parts lists and descriptions, test procedures, and other technical information to assist qualified service personnel in repair and maintenance of the instrument's repairable components. The System Maintenance software is used to perform a new instrument check-in, preventive maintenance tests, and other maintenance functions.

Alarms, Errors, Messages

See the PC Unit section of this DFU for the following system references:

- Alarms, Errors, Messages
- Audio Characteristics
- Definitions
- Radio Frequency Note

Communications Interface Board (CIB) Accessory Model 8012

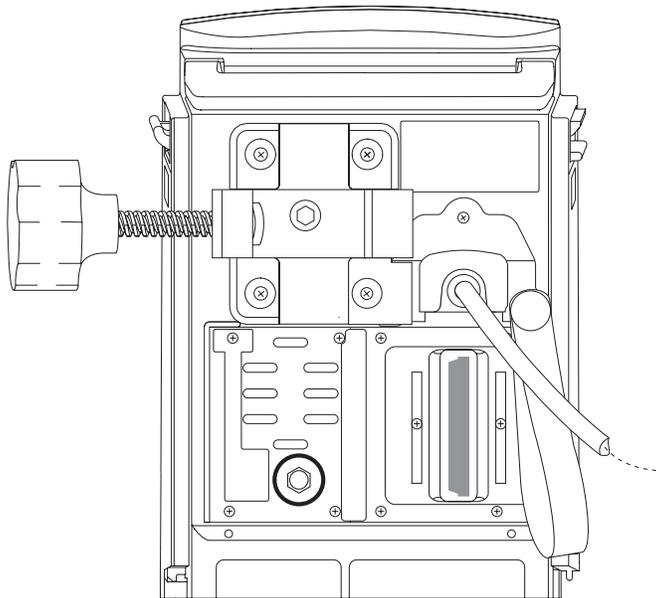

Table of Contents

Introduction	8-1
General Information	
CIB Accessory and CIB LED.....	8-3
Wireless Network Indicator.....	8-3
Troubleshooting and Maintenance	
General.....	8-5
CIB and Alaris® Server Connections	8-5
Alarms, Errors, Messages	8-6

THIS PAGE
INTENTIONALLY
LEFT BLANK

This section of the DFU provides Communications Interface Board Accessory (CIB) instructions and information. It is used in conjunction with:

- Module-specific sections of this DFU
- Nurse Call Accessory section of this DFU (if a Nurse Call and CIB Combination Accessory is installed) ^①
- PC Unit section of this DFU

The CIB is intended to be used with an IEEE 802.11b/g 2.4 GHz wireless network. Once installed in the PC Unit, the CIB provides wireless communication capability between the Alaris® System, Alaris® Server and Mobile Systems Manager.

Combined use of the Alaris® System, CIB, Auto-ID Module, and Alaris® Server:

- Reduces number of manual steps needed to program an infusion (by providing information obtained from Alaris® Server). All data entry and validation of infusion parameters are performed, according to a physician's order, by a trained healthcare professional.
- Is integrated into a facility's existing network infrastructure.

When enabled, the Alaris® Server allows the exchange of information between the Alaris® Server and the Alaris® System. The PC Unit can be operated manually or in concert with the information exchanged with the Alaris® Server. If communication with the wireless network is interrupted (for example, out of range), the Alaris® System can be used, as intended, in the manual mode.

The Mobile Systems Manager does not utilize existing wireless infrastructure. It is intended to be used as a not-fully-functional substitution for the full Systems Manager in hospitals/facilities that do not have wireless communications installed. It can also be used in hospitals/facilities using the full Systems Manager but where wireless coverage is poor.

NOTE:

- ① The CIB Accessory can be used in conjunction with a Nurse Call Accessory only if a Nurse Call and CIB Combination Accessory is installed.

WARNING

Read all instructions, including those for the PC Unit and attached module(s), before using the Alaris® System.

CAUTION

Due to the **intermittent nature of a wireless environment**, some data could be lost if a connection cannot be established or is lost. The Alaris® Server and CIB are designed to minimize these incidents but cannot eliminate them.

THIS PAGE
INTENTIONALLY
LEFT BLANK

CIB Accessory and CIB LED

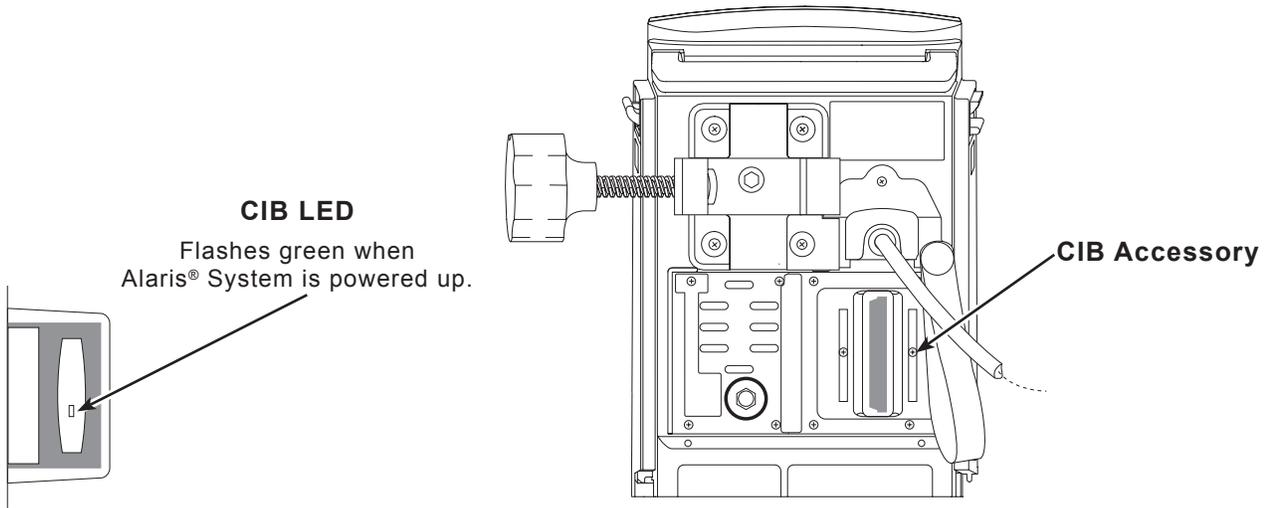

Wireless Network Indicator

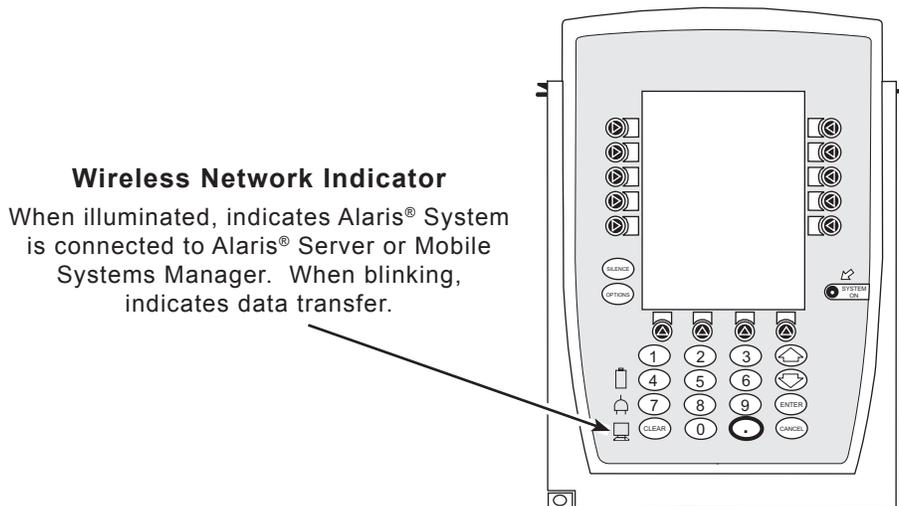

THIS PAGE
INTENTIONALLY
LEFT BLANK

Troubleshooting and Maintenance

General

Troubleshooting and maintenance are intended to be performed only by qualified personnel, using the Alaris® System Technical Service Manuals and the System Maintenance software. The Service Manuals and System Maintenance software are available from CareFusion. The Service Manuals include routine service schedules, interconnect diagrams, component parts lists and descriptions, test procedures, and other technical information to assist qualified service personnel in repair and maintenance of the instrument's repairable components. The System Maintenance software is used to perform a new instrument check-in, preventive maintenance tests, and other maintenance functions.

CIB and Alaris® Server Connections

When an Alaris® Server or Mobile Systems Manager connection is made, the Wireless Network Indicator on the PC Unit lights up. If connection to the Alaris® Server is interrupted, the indicator light is extinguished. Some of the causes for a communications failure include:

- Alaris® Server is not accessible in network, server services are not running, or server has been shut down.
- Wireless connection to access point is down due to wireless network changes.
- Local interference.
- PC Unit has been moved outside wireless coverage area.
- CIB has been damaged.

If an interruption to the Alaris® Server connection continues, the facility's information technology department should be informed.

Alarms, Errors, Messages

See the PC Unit section of this DFU for the following system references:

Alarms, Errors, Messages
Audio Characteristics
Definitions
Radio Frequency Note

Appendix

Maintenance Regulations and Standards

Cleaning

Inspect and clean the product per the following procedures. Read all warnings and cautions before continuing with this procedure.

Alaris® System

Cleaning Products

The following basic cleaners are approved for use on the Alaris® System:

Cleaner	Dilution
10% bleach	1 part bleach to 9 parts water
70% isopropyl alcohol (IPA)	not applicable
mild detergent	per manufacturer's recommendation, as needed
warm water	not applicable

Refer to the following website for additional cleaning product information: www.carefusion.com/customer-support/Alaris-Documents/clinical-documentation.aspx.

Procedure

1. Inspect instrument for damage.
 - a. Inspect instrument for visible external damage, such as a cracked or broken door, case, handle, or latch, or a damaged IUI connector.
 - b. All damages must be repaired prior to placing the instrument back in use.
2. Clean instrument.

Do not allow a cleaning solution other than 70% IPA to contact the IUI connectors. See step 3 for IUI connector cleaning instructions.

 - a. Keep instrument upright and do not allow any part of instrument to become saturated with or submersed in fluid during cleaning operation.

WARNINGS

- To prevent an **electrical hazard**:
 - Turn the instrument off and unplug the power cord from AC power before cleaning.
 - Do not spray fluids directly onto the instrument or into the IUI connectors.
 - Do not steam autoclave, EtO sterilize, immerse the instrument in fluids, or allow fluids to enter the instrument case.
 - Do not connect a module until the IUI connectors are thoroughly dry.
- **Do not use compressed air** to dry the instrument; this could force fluid into the instrument.

CAUTIONS

- The use of **unapproved cleaners and failure to follow** the Alaris® product cleaning procedures and the cleaning product manufacturer's recommended dilutions can result in an instrument malfunction or product damage, such as weakening and cracking of the case, and could void the warranty.
- Do not allow the cleaning solution to contact the **IUI connector** when cleaning the instrument.
- Do not use **hard, abrasive or pointed objects** to clean any part of the instrument.

Cleaning (Continued)

Alaris® System (Continued)

Procedure (Continued)

- b. Clean all exposed surfaces using a disposable wipe or a clean soft cloth dampened with cleaning solution. A soft-bristled brush can be used to clean hard to reach and narrow areas, and to remove hardened organic deposits.
 - c. Remove adhesive residue using 70% IPA.
 - d. Thoroughly remove cleaning solution using a clean soft cloth dampened with water.
3. Clean IUI connectors.
 - a. If surface contaminants, or blue or green deposits, are visible, connector must be replaced.
 - b. Apply 70% IPA to surface of IUI connectors using a soft-bristled brush.
 4. Ensure that instrument, and IUI connectors, are thoroughly dry (dry to the touch) before returning to use. Dry time is dependent on temperature, humidity and area ventilation.

CAUTIONS

- Do not allow cleaning solutions to collect on the instrument. **Residue buildup** might cause the moving parts to become sticky and hinder their operation over time.
- The following **solutions/solvents** can damage the surfaces of the instrument:
 - acetone
 - undiluted alcohol
 - ammonia
 - aromatic solvents (such as naphtha, paint thinner, benzene, Toluene, xylene)
 - Butyl Cellosolve
 - chlorinated solvents (such as Trichloroethane)
 - MEK
 - solutions containing phosphoric acid (such as Foamy Q&A)

Do not use these solutions/solvents or any cleaning product not approved for use by CareFusion.

Handheld Scanner

1. Use a clean soft cloth or lens tissue dampened with warm water or a mild nonabrasive detergent-water solution to clean all exposed surfaces.
2. Use a clean soft cloth or lens tissue dampened with water to rinse off cleaning solution.
3. Ensure that window is dry before returning to use.

CAUTIONS

- Do not use **abrasive wipes or tissues** on the scanner's window.
- Do not use **solvents** such as acetone, benzene, ether, phenol-based agents. These can damage the scanner's finish and window.
- **Do not immerse** in fluids.

Service Information

If the instrument shows evidence of damage in transit, notify the carrier's agent immediately. Do not return damaged equipment to the factory before the carrier's agent has authorized repairs.

If the instrument fails to respond as described in this document and the cause cannot be determined, do not use the instrument. Contact qualified CareFusion service personnel.

If it is necessary to return the instrument for service, obtain a return authorization number prior to shipment. Carefully package the instrument (preferably in the original packaging), refer to the return authorization information, and return it to the appropriate service or distribution center. CareFusion does not assume any responsibility for loss of, or damage to, returned instruments while in transit.

Technical Support

Technical support, service information, applications, and manuals can be obtained by contacting a CareFusion representative.

When submitting any request for service, include:

- model number
- a description of difficulty experienced
- instrument settings
- administration set/lot number
- solution(s) used
- message displayed at time of difficulty

WARNINGS

- The instrument case should only be opened by qualified personnel using **proper grounding techniques**. Prior to performing maintenance, disconnect attached module from the Alaris® System and the PC Unit from AC power.
- During servicing, an instrument's **configuration settings** might be reset to the factory defaults. Qualified hospital/facility personnel are responsible for checking in the instrument and ensuring the current hospital-approved Data Set is loaded.

WARRANTY

CareFusion warrants that:

- A. Each new Alaris® System product is free from defects in material and workmanship under normal use and service for a period of one (1) year from the date of delivery by CareFusion to the original purchaser.
- B. The battery and each new accessory is free from defects in material and workmanship under normal use and service for a period of ninety (90) days from the date of delivery by CareFusion to the original purchaser.

If any product requires service during the applicable warranty period, the purchaser should communicate directly with CareFusion to determine the appropriate repair facility. Except as provided otherwise in this warranty, repair or replacement will be carried out at CareFusion's expense. The product requiring service should be returned promptly, properly packaged and postage prepaid by purchaser. Loss or damage in return shipment to the repair facility shall be at purchaser's risk.

In no event shall CareFusion be liable for any incidental, indirect or consequential damages in connection with the purchase or use of any Alaris® System product. This warranty shall apply solely to the original purchaser. This warranty shall not apply to any subsequent owner or holder of the product. Furthermore, this warranty shall not apply to, and CareFusion shall not be responsible for, any loss or damage arising in connection with the purchase or use of any Alaris® System product which has been:

- 1. repaired by anyone other than an authorized CareFusion Service Representative;
- 2. altered in any way so as to affect, in CareFusion's judgment, the product's stability or reliability;
- 3. subjected to misuse or negligence or accident, or which has had the product's serial or lot number altered, effaced or removed; or
- 4. improperly maintained or used in any manner other than in accordance with the written instructions furnished by CareFusion.

This warranty is in lieu of all other warranties, express or implied, and of all other obligations or liabilities of CareFusion, and CareFusion does not give or grant, directly or indirectly, the authority to any representative or other person to assume on behalf of CareFusion any other liability in connection with the sale or use of Alaris® System products.

CAREFUSION DISCLAIMS ALL OTHER WARRANTIES, EXPRESS OR IMPLIED, INCLUDING ANY WARRANTY OF MERCHANTABILITY OR OF FITNESS FOR A PARTICULAR PURPOSE OR APPLICATION.

See packing inserts for international warranty, if applicable.

Compliance

Electromagnetic Environment

Alaris® System

This system complies with part 18 of the FCC Rules. Operation is subject to the following two conditions:

- This system might not cause harmful interference.
- This system must accept any interference received, including interference that might cause undesired operation.

The digital apparatus does not exceed the Class B limits for radio noise emissions from digital apparatus set out in the radio interference regulations of the Canadian Department of Communications (DOC).

Le présent appareil numérique n'émet pas de bruits radioélectriques dépassant les limites applicables aux appareils numériques de la Classe B prescrites dans le règlement sur le brouillage radioélectrique édicté par le Ministère des Communications du Canada.

This system has been tested and found to comply with the limits for a Class B digital device, pursuant to Part 18 of the FCC Rules. These limits are designed to provide reasonable protection against harmful interference when the system is operated in a commercial environment. This system generates, uses, and can radiate radio frequency energy. If it is not installed and used in accordance with the applicable directions for use, it might cause harmful interference to radio communications. Operation of this system in a residential area is likely to cause harmful interference, in which case the user is required to correct the interference at their own expense.

The authority to operate this system is conditioned by the requirement that no modifications are made to the system unless the changes or modifications are expressly approved by CareFusion Corporation.

This Class B digital apparatus meets all requirements of the Canadian Interference-Causing Equipment Regulation.

Cet appareil numérique de la Classe B respecte toutes les exigences du Règlement sur le matériel brouilleur du Canada.

CAUTION

Any **changes or modifications** not expressly approved by the personnel responsible for compliance could void the user's authority to operate the system.

Compliance (Continued)

Electromagnetic Environment (Continued)

Alaris® System (Continued)

The Alaris® System includes an IEEE 802.11 RF transmitter, as designated by the icon on the rear of the system. It operates on the following frequencies with a maximum radiated power of 100 mW:

- **802.11a:** 5 GHz band, up to 54 Mb/s physical RF specification.
- **802.11b:** 2.4 GHz band, up to 11 Mb/s physical RF specification.
- **802.11g:** 2.4 GHz band, up to 54 Mb/s physical RF specification.

The registration numbers are identified on the RF card installed in the rear of the PC Unit.

Tables: The Alaris® System is intended for use in the electromagnetic environments specified in the following tables.

Table 1
Electromagnetic Emissions

Emissions Test	Compliance	Electromagnetic Environment - Guidance
CISPR 11 RF Emissions	Group 1	<p>Alaris® System uses RF energy only for its internal function in normal product offering. Following icon appears on product. Refer to network card's directions for use for further information.</p> <p style="text-align: center;"></p> <p>RF emissions are very low and are not likely to cause interference with nearby electronic equipment.</p>
CISPR 11 RF Emissions	Class B	Alaris® System is suitable for use in all establishments, including domestic establishments and those directly connected to a public low-voltage power supply network that supplies buildings used for domestic purposes.
IEC 61000-3-2 Harmonic Emissions	Class A	
IEC 61000-3-2 Voltage Fluctuations Flicker Emissions	Complies	

Compliance (Continued)

Electromagnetic Environment (Continued)

Alaris® System (Continued)

Table 2
Electromagnetic Immunity

Emissions Test	IEC 60601-1-2 Test Level ^③	Compliance Level ^③	Electromagnetic Environment - Guidance
IEC 61000-4-2 Electrostatic Discharge (ESD)	±6 kV contact ±8 kV air	±8 kV contact ^① ±15 kV air ^①	<p>Floors should be wood, concrete, or ceramic tile.</p> <p>If floors are covered with synthetic material, relative humidity should be at least 30%.</p> <p>If connector testing exemption is used, following ESD sensitivity symbol appears adjacent to each connector. " - Do Not Touch"</p> <div style="text-align: center;">  </div>
IEC 61000-4-4 Electrical Fast Transient, Burst (EFT) ^②	±2 kV for power supply lines ±1 kV for input/output lines	±2 kV for power supply lines ±1 kV for input/output lines	Mains power quality should be that of a typical commercial or hospital environment.
IEC 61000-4-5 Power Line Surge ^②	±1 kV differential mode ±2 kV common mode	±1 kV differential mode ±2 kV common mode	Mains power quality should be that of a typical commercial or hospital environment.
IEC 61000-4-8 Power Frequency Magnetic Field (50/60 Hz)	3 A/m	400 A/m 50 Hz ^① 400 A/m 60 Hz ^①	Power frequency magnetic fields should be at levels characteristic of a typical location in a typical commercial or hospital environment.

Compliance (Continued)

Electromagnetic Environment (Continued)

Alaris® System (Continued)

Table 2 (Continued)
Electromagnetic Immunity

Emissions Test	IEC 60601-1-2 Test Level ^③	Compliance Level ^③	Electromagnetic Environment - Guidance
IEC 61000-4-11 Voltage Dips, Short Interruptions, and Voltage Variations ^②	<5% U_T (>95% dip in U_T) for 0.5 cycle	<5% U_T (>95% dip in U_T) for 0.5 cycle	Mains power quality should be that of a typical commercial or hospital environment. If continued operation of Alaris® System is required during power mains interruptions, it is recommended that Alaris® System be powered from an uninterruptible power supply or a battery. Alaris® System does employ an internal short duration battery.
	40% U_T (60% dip in U_T) for five cycles	40% U_T (60% dip in U_T) for five cycles	
	70% U_T (30% dip in U_T) for 25 cycles	70% U_T (30% dip in U_T) for 25 cycles	
	<5% U_T (>95% dip in U_T) for 5 sec	<5% U_T (>95% dip in U_T) for 5 sec	

Compliance (Continued)

Electromagnetic Environment (Continued)

Alaris® System (Continued)

Table 3
Electromagnetic Immunity - Life Support Equipment

Immunity Test	IEC 60601-1-2 Test Level	Compliance Level ^①	Electromagnetic Environment - Guidance ^{④ ⑤}
IEC 61000-4-6 Conducted RF	10 Vrms 150 kHz - 80 MHz	20 Vrms	<p>Portable and mobile RF communications equipment should be used no closer to Alaris® System (including cables) than recommended separation distance calculated from equation applicable to frequency of transmitter.</p> <p>Recommended Separation Distance:</p> $d = \left[\frac{12}{V_2} \right] \sqrt{P}$ $d = \left[\frac{12}{E_1} \right] \sqrt{P} \quad 80 \text{ MHz} - 800 \text{ MHz}$ $d = \left[\frac{12}{E_1} \right] \sqrt{P} \quad 80 \text{ MHz} - 2.5 \text{ GHz}$ <p>d = recommended separation distance in meters (m). ^⑥</p> <p>P = maximum output power rating of transmitter in watts (W) according to transmitter manufacturer.</p> <p>Field strengths from fixed RF transmitters, as determined by an electromagnetic site survey, should be less than compliance level in each frequency range. ^{⑦ ⑧}</p> <p>Interference might occur in vicinity of equipment marked with following symbol:</p> 
IEC 61000-4-3 Radiated RF	10 V/m 80 MHz - 2.5 GHz	20 V/m	

Compliance (Continued)

Electromagnetic Environment (Continued)

Alaris® System (Continued)

Table 4 ^④ ^⑤ ^⑥ ^⑨

Recommended Separation Distances

Reduce the potential for electromagnetic interference by maintaining a minimum distance between portable and mobile RF communications equipment (transmitters), and the Alaris® System as recommended in this table, based on the maximum output power of the communications equipment.

For transmitters rated at a maximum output power not listed in this table, the recommended separation distance (d) in meters (m) can be determined using the equation applicable to the frequency of the transmitter, where P is the maximum output power rating of the transmitter in watts (W) based on the transmitter manufacturer.

Rated Maximum Output Power of Transmitter (W)	Separation Distance Based on Transmitter Frequency (m)			
	150 kHz - 80 MHz Outside ISM Bands	150 kHz - 80 MHz In ISM Bands	80 MHz - 800 MHz	800 MHz - 2.5 GHz
	$d = \frac{3.5}{V_1} \sqrt{P}$	$d = \frac{12}{V_2} \sqrt{P}$	$d = \frac{12}{E_1} \sqrt{P}$	$d = \frac{23}{E_1} \sqrt{P}$
0.01	0.02	0.06	0.06	0.12
0.1	0.06	0.19	0.19	0.36
1	0.18	0.6	0.6	1.15
10	0.55	1.9	1.9	3.64
100	1.75	6	6	11.5

Compliance (Continued)

Electromagnetic Environment (Continued)

Alaris® System (Continued)

NOTES:

- ① Compliance levels raised by IEC 60601-2-24.
- ② Performed at the minimum and maximum rated input voltage.
- ③ U_T is the AC mains voltage prior to application of the test level.
- ④ At 80 MHz and 800 MHz, the higher frequency range applies.
- ⑤ These guidelines might not apply in all situations. Electromagnetic propagation is affected by absorption and reflection from structures, objects and people.
- ⑥ The compliance levels in the ISM frequency bands between 150 kHz and 80 MHz, and in the frequency range 80 MHz - 2.5 GHz, are intended to decrease the likelihood that mobile/portable communications equipment could cause interference if inadvertently brought into patient areas. For this reason, an additional factor of 10/3 is used in calculating the recommended separation distance for transmitters in these frequency ranges.
- ⑦ Field strengths from fixed transmitters [such as base stations for radio (cellular/cordless) telephones and mobile radios, amateur radio, AM/FM radio broadcast, TV broadcast] cannot be predicted theoretically with accuracy. To assess the electromagnetic environment due to fixed RF transmitters, an electromagnetic site survey should be considered. If the measured field strength in the location in which the Alaris® System is used exceeds the applicable RF compliance level, the Alaris® System should be observed to verify normal operation. If abnormal performance is observed, additional measures might be necessary, such as reorienting or relocating the Alaris® System.
- ⑧ Over the frequency range 150 kHz - 80 MHz, field strengths should be less than [V.] V/m.
- ⑨ The ISM (Industrial, Scientific and Medical) bands between 150 kHz and 80 MHz are 6.765 - 6.795 MHz, 13.553 - 13.567 MHz, 26.957 - 27.283 MHz, and 40.66 - 40.70 MHz.

Communications Interface Board (CIB) Accessory

The CIB contains a radio frequency, wireless, local-area network interface (RF card). The RF card allows the Alaris® System to communicate with the Alaris® Server connected to the hospital information system. The RF card is compliant with the rules and regulations in the locations where the CIB is sold, and is labeled as required.

The United States Federal Communications Commission (FCC) and Industry Canada (IC) identification numbers are visible through the CIB's clear plastic cover. If an international country approval stamp is required, it is placed adjacent to the identification numbers in the area provided. If the FCC identification number or country approval stamp is not easily visible, the RF card cover may be removed so that the

Compliance (Continued)

Electromagnetic Environment (Continued)

Communications Interface Board (CIB) Accessory (Continued)

information provided can be read. If the RF card cover is removed, ensure that it is reattached—using the screws that were removed, to ensure that the RF card is securely retained and protected against liquid ingress and damage.

The Class B digital device limits are designed to provide reasonable protection against harmful interference when the device is operated as intended. This device generates, uses, and can radiate radio frequency energy. If it is not installed and used in accordance with the applicable directions for use, it might cause harmful interference to radio communications. Operation of this device in a residential area is likely to cause harmful interference, in which case the user is required to correct the interference at their own expense. There is, however, no guarantee that interference will not occur in a particular installation.

If the device does cause harmful interference to radio or television reception (determined by powering system off and on), one or more of the following corrective actions should be taken:

- Reorient or relocate receiving antenna.
- Increase separation distance between system and receiver.
- Connect system into an outlet on a circuit different from that to which receiver is connected.

This Class B digital device meets the requirements of the Canadian Interference Causing Equipment Regulations.

Cet appareil numérique de la Classe B respecte toutes les exigences du Règlement sur le Matériel Brouilleur du Canada.

This Class B digital device meets the requirements of the International community.

Compliance (Continued)

Federal Aviation Regulations

The following Alaris® products have received a Statement of Compliance with Federal Aviation Regulations for use as a "Portable Electronic Device Aboard Aircraft." This is pursuant to the FAA Advisory Circular No. 91-21-1A and attested by an FAA Designated Engineering Representative with an FAA form 8110-3, "Statement of compliance with the Federal Aviation Regulations."

PC Unit
Pump Module
Syringe Module

Standards

The Alaris® System has been assessed and complies with the following standards:

PC Unit and overall System: UL 60601-1, CAN/CSA C22.2 No. 601.1-M90, IEC 60601-1

Auto-ID Module: IEC 60825-1 (LEDs used in Auto-ID Module are not regulated by FDA in the United States; however, they are classified as a CLASS 1 LED PRODUCT in other countries under this standard.)

Communications Interface Board (CIB) Accessory: Class B digital device limits pursuant to Parts 15 (RF Devices and Computing Devices) and 18 (Medical Devices) of the FCC Rules and Regulations. To comply with FCC and Industry Canada exposure requirements, the CIB is approved for operation when there is more than 20 cm between the antenna and the user's or patient's body.

EtCO₂ Module: ISO 9918, ASTM F 1456-01, ASTM F 1463, EN 475, EN 864

PCA, Pump and Syringe Modules: IEC 60601-2-24, ANSI/AAMI ID:26

SpO₂ Module: EN 865

Trademarks

Alaris, Guardrails, and SmartSite are trademarks or registered trademarks of CareFusion Corporation or one of its subsidiaries. LNOP, Masimo, SET, Signal Extraction Technology, and Signal I.Q. are trademarks or registered trademarks of Masimo Corporation. Nellcor, OxiMax, and SatSeconds are trademarks or registered trademarks of Nellcor Puritan Bennett, Inc. Microstream is a registered trademark of Oridion Medical 1987 Ltd. All other trademarks are the property of their respective owners.



Alaris® System Directions for Use
with v9 Model 8000

