

Performa Manual



Definition

The KINETEC Performa is a PASSIVE Knee mobilisation device enabling the extension and flexion movement from de -3° à 130°.

Indications

- Knee replacement surgery.
- Fractures (patellar, tibia plateau, femoral,...).
- Arthrolysis
- Hip surgery, including hip replacement, hip pinning, osteotomy,...).
- Ligament repairs.
- Arthroscopic surgery (menisectomies, patellectomies,...)
- Burns, joints sepsis,...

Clinical Benefits

- Breaks the cycle of trauma, inflammation and the loss of range of motion.
- Prevents joint stiffness.
- Speeds the recovery of post-operative range of motion.
- Maintains the quality of the joint surface.
- Reduces pain and oedema.
- Promotes joint cartilage healing.
- Reduces hospitalization time
- Reduces the need for pain medication.
- Provides immediate post-operative continuous passive motion.
- Digital ROM readout on the patient hand control for positive reinforcement.
- Maintains desired positions for stretching and muscular rest.

Contraindications

Bone Cancer, warped joint surfaces, spastic paralysies, unstable fractures, uncontrolled infection.
The machine is not suitable for patients over 2,06 m or under 1,12m.

Warning and Safety instructions

- Warning: The physician/physiotherapist defines the protocol and ensures that it is correctly implemented (adjustments, session time and frequency of use).
- Warning: Run a cycle with the device unloaded before installing the patient on the machine.
- Warning: For optimum safety, always give the hand control to the patient before starting the system. The patient must know the start/stop/reverse function on the hand control, see page 3.
- Warning: To avoid the parameters being changed, lock the machine's hand control before giving it to the patient.
- Warning: Danger, risk of explosion: Do not use the machine with anaesthetic gas or in an environment that is rich in oxygen.
- Warning: To avoid all risks of electric shock, the machine should only be connected to a power supply that has protective earthing.
- Warning: Before using this machine, always check that the electrical socket is in good condition and is suitable for the splint power supply cord. Only use the original cable supplied with the machine. Check that the cables remain free around the device so that they do not get damaged.
- Warning: Before using this machine, always check that the machine is not damaged, in particular the protective housings and the power cord.
- Warning: In case of electromagnetic interference with other devices move the device.
- Warning: Please do not touch the moving parts while the unit is running, pinching risk.
- Warning: Modifying the machine in any way is strictly forbidden.

Compliance:

KINETEC Performa complies with the standards of Directive 93/42/EEC, and bears the CE mark.
KINETEC Performa complies with the standards in force (IEC 601.1.2) concerning the electromagnetic compatibility of medical devices.
KINETEC Performa complies with the standards of Directives Machine n°2006/42/CE.

Description

The KINETEC Performa machine consists of the following components:

- 1 • Lower limb support.
- 2 • Thigh support.
- 3 • Foot support.
- 4 • Hand control.
- 5 • Thigh support setting lock.
- 6 • Lower limb support setting lock.
- 7 • Foot support positioning setting lock.
- 8 • Transport handle.
- 9 • ON/OFF switch and fuses.

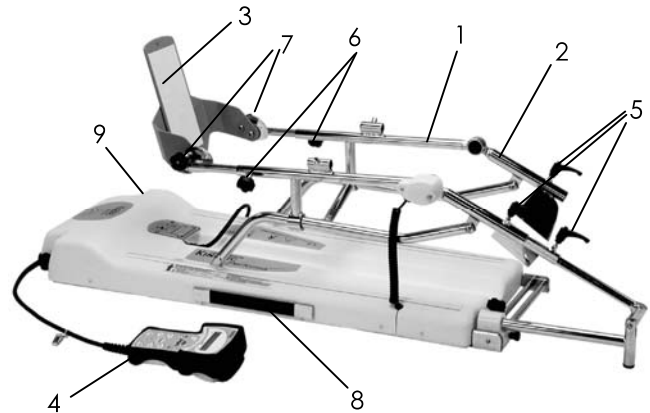

- 10 • Liquid-crystal display.
- 11 • Increase / decrease keys.
- 12 • EXTENSION setting key.
- 13 • FLEXION setting key.
- 14 • STOP key.
- 15 • START key.
- 16 • PAUSE key.
- 17 • SPEED key.
- 18 • FORCE key.
- 19 • TIMER key.
- 20 • Reading or selecting SYNCHRO-STIMULATOR (please request the instruction sheet from your KINETEC distributor).

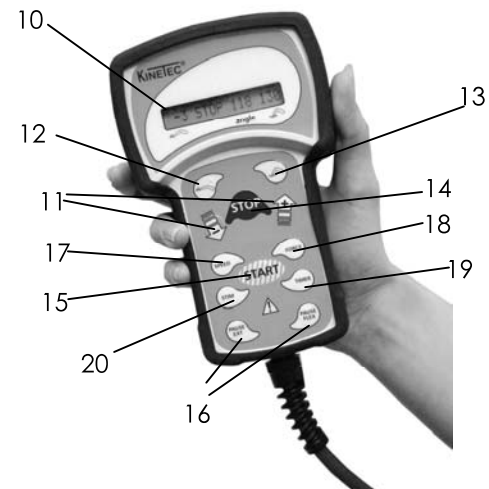

Display Details:

- A • 3-character area showing the extension limit.
- B • 3-character area showing the flexion limit.
- C • 8-character area showing various messages (RUN, STOP, EXT, FLEX, SPEED, FORCE, PAUSE, etc...).
- D • 3-character area showing the real-time angle of the knee; this value changes in line with the movement.

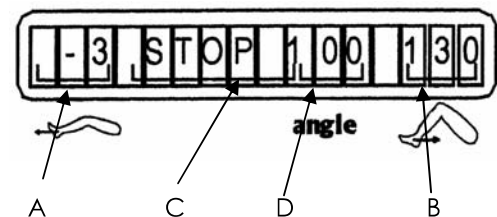

Electrical connection: SAFETY FIRST.

The KINETEC Performa is type B, class I devices.

Before connecting the device to the power supply, check that the mains voltage matches that shown on the identification plate (100-240 V~ 50-60Hz).

Connect the power supply cable (21).

IMPORTANT

Check that the electrical socket is in good condition and is suitable for the splint power supply cord. The latter complies with current standards and has a grounding socket.

The plug may be connected to any standard socket.

The socket must however have a grounded pin.

To connect the power supply, only use the original cable supplied with the machine.

Check that the cables remain free around the device so that they do not get damaged.

Check that the machine is not damaged, in particular the protective housings.

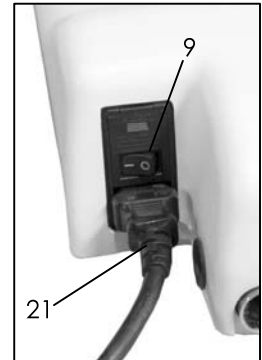

Starting the unit

Switch on the unit (9). The display comes on and then the display shows: **KINETEC PERFORMA**
Your KINETEC Performa is ready to be used.

START/STOP/REVERSE function

As with all KINETEC systems, KINETEC Performa is equipped with a START/STOP/REVERSE function.

Press the **STOP** key of the hand control. The movement stops,

Press the **START** key of the hand control. The movement starts in the opposite direction.

Caution:

For optimum safety, always give the hand control to the patient before starting the system.

Procedure to stop the machine:

To stop the machine's movement: Press the **STOP** button.

To switch power off: press the ON / OFF switch (9).

Locking the hand control setting

The hand control allows the patient to control the machine as appropriate.



UNLOCKED POSITION (22) adjustments are possible.



LOCKED POSITION (22) the OPERATIONAL settings can be read and the Start/Stop/Reverse function operated.

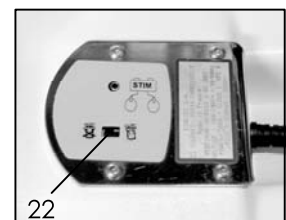

Double Blocage :

Simultaneously press the **PAUSE EXT** and **PAUSE FLEX** keys to lock the hand control, The display reads **LOCK**, you cannot change the parameters, if you try the display reads **VERROU SOFT**. To unlock the hand control, simultaneously press the same keys, The display reads **UNLOCK**.

We recommend that you lock the hand control when you give it to the patient.

Note: The hand control locking is preserved when you switch the unit ON/OFF.

Setting the movement parameters

Select the parameter to be set:

Extension limit, flexion limit, speed, pause at the extension or flexion limit, force or timer; the setting to change will flash.

Press the or buttons to modify the setting; the new setting will flash.

To confirm the new setting, press another function button or wait approximately 5 seconds for automatic confirmation.

Movement parameters can be set either when the machine is stopped or when it is in operation.

At the end of the session, the display reads and the unit stops at an average angle use. Press or to select a new session time.

Possible values for each parameter:

	Possible values
• Extension limit	-3 to 125°
• Flexion limit	2° to 130°
• Speed	1 to 7 (from 50° to 220° per minute)
• Force	1 to 6
• Extension pause	0 to 900 seconds (15minutes)
• Flexion pause	0 to 900 seconds (15minutes)
• Timer	0 to 24h00

DAILY COUNTER function: "RESET TIME"

With the splint stopped, simultaneously press the and buttons. This function allows you to see how long the appliance has been operating since it was last reset.

Press the button twice to reset the counter, or to exit without resetting it.

MANUAL MODE - Start of a session

This function allows you to define and save the maximum limits supported by the patient. This mode is generally used at the start of a session.

With the Kinetec Performa on , keep the following buttons pressed for at least 3 seconds:

- to define the extension limit,
- to define the flexion limit,

and then the movement limit buttons to memorise the actual angle reached.

BY-PASSING MODE - During a session

This function allows you to define and save the maximum limits supported by the patient. This mode is generally used during a session.

With the Kinetec Performa on , keep the following buttons pressed for at least 3 seconds:

- to exceed the programmed limit and define a new extension limit,
- to exceed the programmed limit and define a new flexion limit,

and then the movement limit buttons to memorise the actual angle reached.

Using the Plastic Comfort Case kit

Specially designed to improve comfort and hygiene for the patient.

The Plastic Comfort Cases come with straps to precisely and quickly adjust to the patient's leg dimensions.

CLEANING

To ensure optimal hygiene, clean the supports after each patient use

Use a DISINFECTANT product (alcohol-free or <5% alcohol solution) in spray (plastic cases and metal components).

Replacement parts

23 4670024048 Complete foot support

24 4635010561 Foot support strap kit

25 4670023686 Tibia case with straps

26 4670023694 Femur case with straps

27 4670016657 Thigh bar

28 4645000841 Single strap

Part number to order

a complete kit: 4670017655

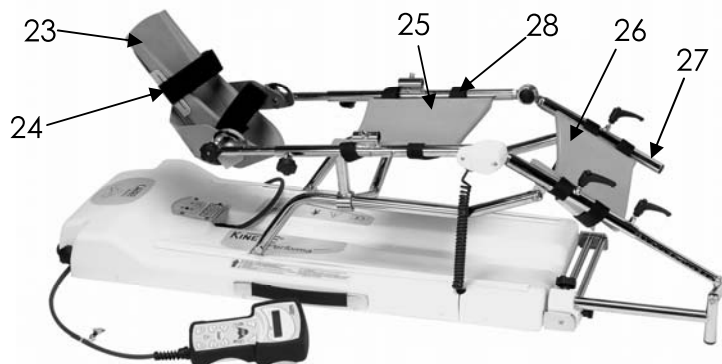

Use of the Kinetec Patient Pad Kit

The KINETEC Patient Pad Kit is designed for rapid fitting, optimal hygiene and maximum patient comfort.

- Position the straps on the leg and thigh cradles, make sure that the self-adhesive parts are visible.
- Place the sponge side next to the skin.

**FOR OPTIMAL HYGIENE, A NEW SET OF PADS SHOULD BE USED FOR EACH PATIENT.
Each cover is provided with a label to record the patient's name.**

- CLEANING:

- Sterilization of the pads (if necessary): Sterilized at 134 °C during 18 minutes.

- Disinfecting of the pads: Washing at 30°C with use of a disinfecting solution during the rising cycle.

Example of products that can be used: Solution "Bacling" at 0.125 % or "Souplanos" at 0,125% from ANIOS Laboratory. A complete list of distributors in your country is available on request.

The KINETEC Performa is delivered with a complete set. Components:

- 4 straps (4650001107)

- 1 foot support (4650001131)

- 1 cover (4650001090)

Part number to order the complete set: 4650001058





ADJUSTING FOR RIGHT OR LEFT LEG

The KINETEC Performa is designed anatomically. Because of this the thigh slide (29) should always be placed on the same side as the leg to be mobilised.

To change legs, proceed as follows:

- Withdraw the hip bar (29) from thigh support bar (B). (2).
- Slide the hip bar into the thigh support bar on the other side of the exerciser and attach the hip bar on the thigh support. (a index confirms the good position)).

IMPORTANT: if the knobs (5) are not tighten the device stops and the display reads **SERVICE D2**.

Therefore it is possible to move **MANUALLY** the machine by depressing the key  or , for more than 3 seconds.

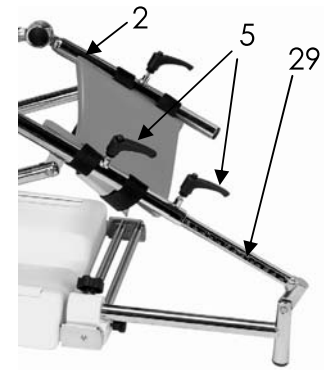

Setting up the patient

Place the KINETEC Performa machine in a position that will be comfortable for the patient.

- Measure in cm or inches the length of the patient's femur (L); adjust the thigh support to this measurement using knobs (5).
- To install the patient on the KINETEC Performa machine.
- Push the foot plate (3) up to the patient and tighten the knobs (6).
- Adjust the plantar flexion (40°) or the dorsal flexion (30°) of the foot, with the knobs (7).
- Adjust the internal (30°) or external (30°) flexion of the foot, with the knob (30).

IMPORTANT

Adjust the axis of the patient's hip (31) with the axis rotation (32) of the KINETEC Performa machine, and the axis of the patient's knee (33) with the axis rotation (34) of the KINETEC Performa machine.

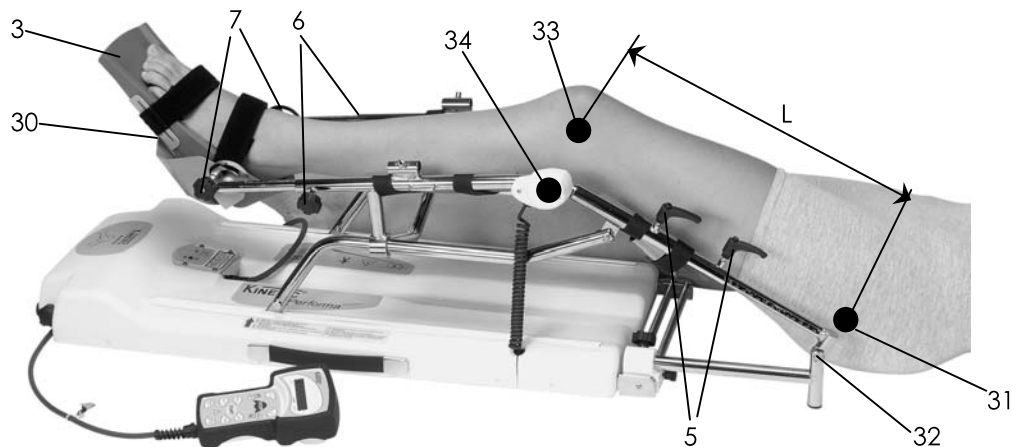

Options



Trolley for all CPM
Part number to order: 4655001053



Cart for bed use
Part number to order: 4665003297
Performa adaptation plate
Part number to order: 4665003560

Maintenance

After 2,000 hours of operation, the KINETEC Performa requires lubrication and maintenance operations (lubrication of the joints, pointer stops and ball screws). The need for maintenance is indicated by display of the message **SERVICE** when the system is switched on.

Despite that warning, you can continue to use your KINETEC Performa by pressing **START** but you should contact your nearest KINETEC technician to have the maintenance operations conducted as soon as possible.

When the machine is no longer in working condition, please return it to us, together with its accessories, for destruction.

Troubleshooting

A spare parts list and technical catalog are available to you on request from your KINETEC distributor.

If, after connecting the power supply cable to the power supply and switching on the KINETEC Performa:

- The display does not indicate any information:
 - Check that the electrical socket is live using another device.
 - Replace the fuse(s) (35) of the connector with fuses of the same type and calibre: 2 fuses T 500 mA 250V (6,3x32mm) (KINETEC order: 4610002400).
 - If the display still does not indicate any information, contact your nearest KINETEC technician.
- Your KINETEC Performa does not work and the display indicates **50 STOP 25 115**. Press **START** again.
Your KINETEC Performa still does not function: Contact your nearest KINETEC technician.
- Your KINETEC Performa does not function and the display indicates:
 - Or **SERVICE D1** : angle measurement function failure,
 - Or **SERVICE D2** : failure during motion,
 - Or **SERVICE D3** : failure of motor direction,Contact your nearest KINETEC technician if the same message is displayed after having switched the device off, then on, and started it by pressing **START**.

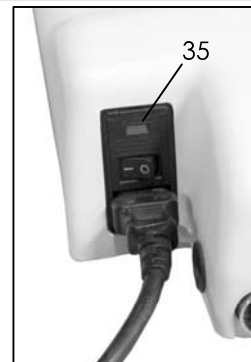

Cleaning

Avant tout, mettre l'appareil HORS TENSION en déconnectant le cordon secteur. Nous recommandons un nettoyage entre chaque patient.

Le nettoyage est réalisé dans les conditions environnementales spécifiées dans le paragraphe « Caractéristiques techniques » ci-après.

Utiliser un produit de DESINFECTATION (solution sans alcool ou < à 5% d'alcool) par pulvérisation des SURFACES (coques plastiques et éléments métalliques).

Afin d'assurer une hygiène optimale, il est conseillé de nettoyer les habillages après chaque patient, tous les consommables de l'appareil peuvent être jetés sans danger.

Elimination and recycling

- a • **Packing:** Packing must be separated from the components plastic and paper/cardboard and given to the specific sites for recycling.
- b • **KINETEC PATIENT PAD KIT:** Clean with disinfectant then to give it to the specific sites for recycling.
- c • **Unit:** It contains electronic components, cables, aluminium, steel and plastic parts. When the splint is not operational any more, to dismount and separate in groups from materials and to give them to correct unit of recycling or return the machine to Kinetec for destruction.

Technical specifications

Product:

Weight: 15Kg
 Splint dimensions: 109cm x 33cm x 33cm
 Angular limits: -3° to 130°
 Speed: from 50 to 220° per minute.
 Patient height: Maximum Weight: 135kg
 Patient sizing: 112 to 206 cm
 Full leg: 58 to 110 cm
 Tibia: 32 to 60 cm
 Femur: 26 to 50 cm

Sound pressure: <70dB

Electricity:



























Power supply: 100-240 V~
 Frequency: 50-60Hz
 Power consumption: 50VA
 Device of type B class I
 IP 20.
 Fuse T 500mA 250V 6,3x32mm (KINETEC order: 4610002400)

Environment:

- Storage/transport conditions: Temperature: -40 to 70°C / -40 to 160°F
 Relative humidity: up to 90%

- Operating conditions: Room temperature: 10 to 40°C / 50 to 105°F
 Relative humidity: up to 80%

Symbols used

	TYPE B device (protection against electric shocks)		Speed		Flexion limit
	Warning or CAUTION (check accompanying documentation)		Force		Extension limit
	STOP (power off)		Increase		Start movement
	ON (power on)		Decrease		Stop movement
	Refer to the operating instructions		Temperature Limit during storage or transport		Alternative current
	Right way up when box is stored		Fragile		Keep dry during storage or transport
	Contains electric and electronic components; not to throw in the dustbins of household refuse		Hand control unlock		Hand control lock
	Pause		Pause		Timer
	SYNCHRO-STIMULATOR		Plug for synchro-stimulator		

Warranty

The KINETEC warranty is strictly limited to the replacement free of charge or repair in the plant of the component or components found to be defective.
 KINETEC guarantees its joint passive mobilization systems for 2 years against all defects of manufacture from the date of purchase by the consumer.
 KINETEC is the only organization able to assess the application of the warranty to its systems.
 The warranty will be considered null and void if the device has been used abnormally or under conditions of use other than those indicated in the user's manual.
 The warranty will also be considered null and void in the event of deterioration or an accident due to negligence, inappropriate surveillance or inappropriate maintenance, or due to transformation of the equipment or an attempt to repair the equipment.

GUIDANCE AND MANUFACTURER'S DECLARATION

Electromagnetic emissions

The « KINETEC Performa » is intended for use in the electromagnetic environment specified below.

The customer or the user of the « KINETEC Performa » should ensure that it is used in such an environment.

Emissions test	Compliance	Electromagnetic environment – guidance
Radio electric-Frequency emissions CISPR 11	Group 1	The « KINETEC Performa » uses RF energy only for its internal function. Therefore, its RF emissions are very low and are not likely to cause any interference in nearby electronic equipment.
Radio electric-Frequency emissions CISPR 11	Class B	The « KINETEC Performa » is suitable for use in all establishments including domestic establishments and those directly connected to the public low-voltage power supply network that supplies buildings used for domestic purposes.
Harmonic emissions IEC 61000-3-2	Non Applicable	
Voltage fluctuations / Flicker emissions IEC 61000-3-3	Complies	

Electromedical appliances require special precautions concerning EMC. They therefore need to be installed and commissioned following the EMC information supplied.

Electromedical appliances may be affected by mobile and portable RF communication devices.

WARNING: using cables and accessories other than those specified, except for those sold by Kinetec as replacements for internal components, may lead to an increase in emissions or a decrease in the "KINETEC PERFORMA" splint's immunity.

WARNING: the "KINETEC PERFORMA" splint should not be used next to other appliances. If the "KINETEC PERFORMA" splint must be used next to other appliances, the splint should be under constant supervision to check that it is working normally in the given configuration.

Electromagnetic immunity

The « KINETEC Performa » is intended for use in the electromagnetic environment specified below.

The customer or the user of the « KINETEC Performa » should ensure that it is used in such an environment.

Immunity test	IEC 60601 Test level	Compliance level	Electromagnetic environment – guidance
Electrostatic discharge (ESD) IEC 61000-4-2	±2 kV, ±4 kV, ±6 kV contact ±2 kV, ±4 kV, ±8 kV air	±2 kV, ±4 kV, ±6 kV contact ±2 kV, ±4 kV, ±8 kV air	Floors should be wood, concrete or ceramic tile. If floors are covered with synthetic material, the relative humidity should be at least 30%.
Electrical fast transient / burst IEC 61000-4-4	±2 kV for power supply lines ±1 kV for input/output lines	±2 kV for power supply lines Non Applicable	Mains power quality should be that of a typical commercial or hospital environment.
Surge IEC 61000-4-5	±1 kV between lines ±2 kV between line and earth	±1 kV between lines ±2 kV between line and earth	Mains power quality should be that of a typical commercial or hospital environment.
Voltage dips and voltage variations on power supply input lines CEI 61000-4-11	< 5% U_T (>95% dip in U_T) for 0,5 cycle 40% U_T (60% dip in U_T) for 5 cycles 70% U_T (30% dip in U_T) for 25 cycles < 5% U_T (>95% dip in U_T) for 5 seconds	< 5% U_T (>95% dip in U_T) for 0,5 cycle 40% U_T (60% dip in U_T) for 5 cycles 70% U_T (30% dip in U_T) for 25 cycles < 5% U_T (>95% dip in U_T) for 5 seconds	Mains power quality should be that of a typical commercial or hospital environment. If the user of the « KINETEC Performa » requires continued operation during power supply interruptions, it is recommended that the « KINETEC Performa » be powered from an uninterruptible power supply or a battery.
Power frequency (50/60 Hz) magnetic field IEC 61000-4-8	3A/m	3A/m	Power frequency magnetic fields should be at levels characteristic of a typical location in a typical commercial or hospital environment.

NOTE : U_T is the a.c. mains voltage prior to application of the test level.

GUIDANCE AND MANUFACTURER'S DECLARATION

Electromagnetic emissions

The « KINETEC Performa » is intended for use in the electromagnetic environment specified below.
The customer or the user of the « KINETEC Performa » should ensure that it is used in such an environment.

Immunity test	IEC 60601 Test level	Compliance level	Electromagnetic environment – guidance
Conducted RF interference IEC 61000-4-6	3 V _{eff} from 150 kHz to 80 MHz	3 V	<p>Mobile and portable RF communication devices should not be used closer to any part of the "KINETEC PERFORMA" splint, including its cables, than the recommended separation distance, calculated based on the equation applicable to the emitter's frequency.</p> <p>Recommended separation distance</p> $d = 1.2 \sqrt{P}$ <p>$d = 1.2 \sqrt{P}$ from 80 MHz to 800 MHz</p> <p>$d = 2.3 \sqrt{P}$ from 800 MHz to 2.5 GHz</p> <p>where P is the emitter's maximum output power characteristic in watts (W), according to the emitter's manufacturer, and d is the recommended separation distance in metres (m).</p> <p>The field intensities of fixed RF emitters, determined by an on-site electromagnetic investigation^a, should be below the compliance level in each frequency range^b.</p> <p>There may be interference near appliances bearing the following symbol:</p> 
Radiated RF interference IEC 61000-4-3	3 V/m from 80 MHz to 2.5 GHz	3 V/m	

NOTE 1 At 80 and 800 MHz, the highest frequency range is applicable.

NOTE 2 These directives cannot be applied in every situation. Electromagnetic propagation is affected by absorption and reflection by structures, objects and people.

^a The field intensity of fixed emitters such as base stations for radio-telephones (cellular/cordless) and land mobile radios, amateur radio, AM/FM radio broadcasts and TV broadcasts cannot be predicted exactly in theory. To evaluate the electromagnetic environment due to fixed RF emitters, an on-site electromagnetic investigation should be considered. If the field intensity measured where the "KINETEC PERFORMA" splint is used exceeds the aforementioned applicable RF compliance level, the "KINETEC PERFORMA" splint should be monitored to check that it is working normally. If abnormal results are observed, additional measures may be necessary, such as reorienting or repositioning the "KINETEC PERFORMA" splint.

^b Over the frequency range from 150 kHz to 80MHz, field intensities should be less than 3V/m.

Recommended separation distances between mobile and portable RF communication devices and the "KINETEC PERFORMA" unit

The "KINETEC PERFORMA" splint is designed to be used in an electromagnetic environment in which radiated RF interference is controlled. The "KINETEC PERFORMA" splint customer or user can help prevent electromagnetic interference by maintaining a minimum distance between mobile and portable RF communication devices (emitters) and the "KINETEC PERFORMA" splint, as recommended below, according to the communication device's maximum output power.

Maximum assigned output power for the emitter W	Separation distance according to the emitter's frequency m		
	from 150 kHz to 80 MHz $d = 1.2 \sqrt{P}$	from 150 kHz to 80 MHz $d = 1.2 \sqrt{P}$	from 150 kHz to 80 MHz $d = 1.2 \sqrt{P}$
0,01	0.12	0.12	0.12
0,1	0.38	0.38	0.38
1	1.2	1.2	1.2
10	3.8	3.8	3.8
100	12	12	12

For emitters whose assigned maximum emitted power is not given above, the recommended separation distance d in metres (m) can be estimated using the equation applicable to the emitter frequency, where P is the emitter's maximum emission power characteristic in watts (W) according to the latter's manufacturer.

NOTE 1 At 80 and 800 MHz, the separation distance for the highest frequency range is applicable.

NOTE 2 These directives cannot be applied in every situation. Electromagnetic propagation is affected by absorption and reflection by structures, objects and people.